

# NB4N111K

## 3.3V Differential In 1:10 Differential Fanout Clock Driver with HCSL Level Output

### Description

The NB4N111K is a differential input clock 1 to 10 HCSL fanout buffer, optimized for ultra low propagation delay variation. The NB4N111K is designed with HCSL clock distribution for FBDIMM applications in mind.

Inputs can accept differential LVPECL, CML, or LVDS levels. Single-ended LVPECL, CML, LVCMOS or LVTTL levels are accepted with the proper  $V_{REFAC}$  supply (see Figures 5, 10, 11, 12, and 13). Clock input pins incorporate an internal  $50\ \Omega$  on die termination resistors. Outputs can interface with LVDS with proper termination (See Figure 15).

The NB4N111K specifically guarantees low output-to-output skews. Optimal design, layout, and processing minimize skew within a device and from device to device. System designers can take advantage of the NB4N111K's performance to distribute low skew clocks across the backplane or the motherboard.

### Features

- Typical Input Clock Frequencies: 100, 133, 166, 200, 266, 333, and 400 MHz
- 340 ps Typical Rise and Fall Times
- 800 ps Typical Propagation Delay
- $\Delta t_{pd}$  100 ps Maximum Propagation Delay Variation Per Each Differential Pair
- $<1$  ps RMS Additive Clock jitter
- Operating Range:  $V_{CC} = 3.0\text{ V to }3.6\text{ V}$  with  $V_{EE} = 0\text{ V}$
- Differential HCSL Output Level or LVDS with Proper Termination
- These are Pb-Free Devices



ON Semiconductor®

<http://onsemi.com>

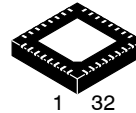

QFN32  
MN SUFFIX  
CASE 488AM

### MARKING DIAGRAM\*

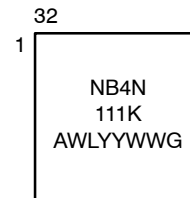

- A = Assembly Site
- WL = Wafer Lot
- YY = Year
- WW = Work Week
- G = Pb-Free Package

\*For additional marking information, refer to Application Note AND8002/D.

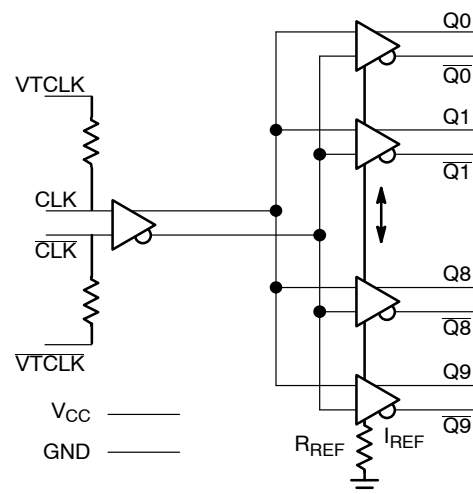
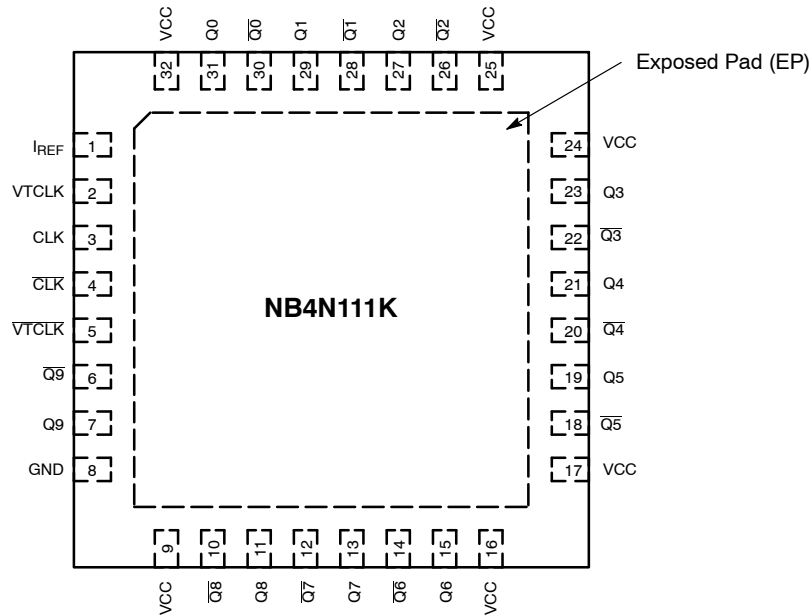

Figure 1. Pin Configuration (Top View)

### ORDERING INFORMATION

See detailed ordering and shipping information in the package dimensions section on page 9 of this data sheet.

# NB4N111K



**Figure 2. Pinout Configuration (Top View)**

**Table 1. PIN DESCRIPTION**

Pin	Name	I/O	Description
1	I <sub>REF</sub>	Output	Output current programming pin. Connect to GND. (See Figure 9).
2, 5	VTCLK, VTCLK	-	Internal 50 Ω Termination Resistor connection Pins. In the differential configuration when the input termination pins are connected to the common termination voltage, and if no signal is applied then the device may be susceptible to self-oscillation.
3	CLK	LVPECL Input	CLOCK Input (TRUE)
4	CLK	LVPECL Input	CLOCK Input (INVERT)
8	GND	-	Supply Ground. GND pin must be externally connected to power supply to guarantee proper operation.
9, 16, 17, 24, 25, 32	V <sub>CC</sub>	-	Positive Supply pins. V <sub>CC</sub> pins must be externally connected to a power supply to guarantee proper operation.
6, 10, 12, 14, 18, 20, 22, 26, 28, 30	Q[09-0]	HCSL or LVDS Output	Noninverted Clock Output. (For LVDS levels see Figure 15)
7, 11, 13, 15, 19, 21, 23, 27, 29, 31	Q[09-0]	HCSL or LVDS Output	Inverted Clock Output. (For LVDS levels see Figure 15)
Exposed Pad	EP	GND	Exposed Pad. The thermally exposed pad (EP) on package bottom (see case drawing) must be attached to a sufficient heat-sinking conduit for proper thermal operation. (Note 1)

1. The exposed pad must be connected to the circuit board ground.

# NB4N111K

**Table 2. ATTRIBUTES**

Characteristic	Value
Input Default State Resistors	None
ESD Protection Human Body Model	>2 kV
Moisture Sensitivity (Note 2) QFN32	Level 1
Flammability Rating Oxygen Index: 28 to 34	UL 94 V-0 @ 0.125 in
Transistor Count	622
Meets or exceeds JEDEC Spec EIA/JESD78 IC Latchup Test	

2. For additional information, see Application Note AND8003/D.

**Table 3. MAXIMUM RATINGS** (Note 3)

Symbol	Parameter	Condition 1	Condition 2	Rating	Unit
V <sub>CC</sub>	Positive Power Supply	GND = 0 V		6.0	V
V <sub>I</sub>	Positive Input	GND = 0 V		GND - 0.3 ≤ V <sub>I</sub> ≤ V <sub>CC</sub>	V
V <sub>INPP</sub>	Differential Input Voltage  CLK - $\overline{\text{CLK}}$			V <sub>CC</sub>	V
I <sub>OUT</sub>	Output Current	Continuous Surge		50 100	mA mA
T <sub>A</sub>	Operating Temperature Range	QFN32		-40 to +70	°C
T <sub>stg</sub>	Storage Temperature Range			-65 to +150	°C
θ <sub>JA</sub>	Thermal Resistance (Junction-to-Ambient) (Note 3)	0 lfpm 500 lfpm	QFN32 QFN32	31 27	°C/W °C/W
θ <sub>JC</sub>	Thermal Resistance (Junction-to-Case)	2S2P (Note 4)	QFN32	12	°C/W
T <sub>sol</sub>	Wave Solder Pb-Free			265	°C

Stresses exceeding Maximum Ratings may damage the device. Maximum Ratings are stress ratings only. Functional operation above the Recommended Operating Conditions is not implied. Extended exposure to stresses above the Recommended Operating Conditions may affect device reliability.

3. JEDEC standard 51-6, multilayer board - 2S2P (2 signal, 2 power).

4. JEDEC standard multilayer board - 2S2P (2 signal, 2 power) with 8 filled thermal vias under exposed pad.

# NB4N111K

**Table 4. DC CHARACTERISTICS** ( $V_{CC} = 3.0\text{ V to }3.6\text{ V}$ ,  $T_A = -40^\circ\text{C to }+70^\circ\text{C}$  Note 5)

Symbol	Characteristic	Min	Typ	Max	Unit
$I_{GND}$	GND Supply Current (All Outputs Loaded)	70	98	120	mA
$I_{CC}$	Power Supply Current (All Outputs Loaded)			300	mA
$I_{IH}$	Input HIGH Current CLKx, $\overline{\text{CLKx}}$		2.0	150	$\mu\text{A}$
$I_{IL}$	Input LOW Current CLKx, $\overline{\text{CLKx}}$	-150	-2.0		$\mu\text{A}$

**DIFFERENTIAL INPUT DRIVEN SINGLE-ENDED** (Figures 5 and 7)

$V_{th}$	Input Threshold Reference Voltage Range (Note 6)	1050		$V_{CC} - 150$	mV
$V_{IH}$	Single-Ended Input HIGH Voltage	$V_{th} + 150$		$V_{CC}$	mV
$V_{IL}$	Single-Ended Input LOW Voltage	GND		$V_{th} - 150$	mV

**DIFFERENTIAL INPUTS DRIVEN DIFFERENTIALLY** (Figures 6 and 8)

$V_{IHD}$	Differential Input HIGH Voltage	1200		$V_{CC}$	mV
$V_{ILD}$	Differential Input LOW Voltage	GND		$V_{CC} - 75$	mV
$V_{ID}$	Differential Input Voltage ( $V_{IHD} - V_{ILD}$ )	75		2400	mV
$V_{CMR}$	Input Common Mode Range	1163		$V_{CC} - 75$	

**HCSL OUTPUTS** (Figure 4)

$V_{OH}$	Output HIGH Voltage	600	740	900	mV
$V_{OL}$	Output LOW Voltage	-150	0	150	mV

NOTE: Device will meet the specifications after thermal equilibrium has been established when mounted in a test socket or printed circuit board with maintained transverse airflow greater than 500 lpm. Electrical parameters are guaranteed only over the declared operating temperature range. Functional operation of the device exceeding these conditions is not implied. Device specification limit values are applied individually under normal operating conditions and not valid simultaneously.

- Input parameters vary 1:1 with  $V_{CC}$ . Measurements taken with all outputs loaded 50  $\Omega$  to GND, see Figure 9.
- $V_{th}$  is applied to the complementary input when operating in single ended mode.

# NB4N111K

**Table 5. AC CHARACTERISTICS**  $V_{CC} = 3.0\text{ V to }3.6\text{ V}$ ,  $GND = 0\text{ V}$ ;  $-40^{\circ}\text{C to }+70^{\circ}\text{C}$  (Note 7)

Symbol	Characteristic	Min	Typ	Max	Unit
$V_{OUTPP}$	Output Voltage Amplitude (@ $V_{INPPmin}$ ) $f_{in} = 400\text{ MHz}$		725	1000	mV
$t_{PLH}$ , $t_{PHL}$	Propagation Delay to (See Figure 3) $CLK/\overline{CLK}$ to $Qx/\overline{Qx}$	550	800	1100	ps
$\Delta t_{PLH}$ , $\Delta t_{PHL}$	Propagation Delay Variations Variation Per Each Diff Pair $CLK/\overline{CLK}$ to $Qx/\overline{Qx}$ (Note 8) (See Figure 3)			100	ps
$t_{SKEW}$	Duty Cycle Skew (Note 9) Within-Device Skew Device-to-Device Skew (Note 10)			20 100 150	ps ps ps
$t_{JITTER}$	RMS Random Clock Jitter (Note 11) $f_{in} = 400\text{ MHz}$			1	ps
$V_{cross}$	Absolute Crossing Magnitude Voltage	250		550	mV
$\Delta V_{cross}$	Variation in Magnitude of $V_{cross}$			150	mV
$t_r$ , $t_f$	Absolute Magnitude in Output Risetime and Falltime (From 175 mV to 525 mV) $Qx, \overline{Qx}$	175	340	700	ps
$\Delta t_r$ , $\Delta t_f$	Variation in Magnitude of Risetime and Falltime (Single-Ended) (See Figure 4) $Qx, \overline{Qx}$			125	ps

NOTE: Device will meet the specifications after thermal equilibrium has been established when mounted in a test socket or printed circuit board with maintained transverse airflow greater than 500 lpm. Electrical parameters are guaranteed only over the declared operating temperature range. Functional operation of the device exceeding these conditions is not implied. Device specification limit values are applied individually under normal operating conditions and not valid simultaneously.

7. Measured by forcing  $V_{INPP}$  (MIN) from a 50% duty cycle clock source. Measurements taken with all outputs loaded  $50\ \Omega$  to GND, see Figure 9. Typical gain is 20 dB.
8. Measured from the input pair crosspoint to each single output pair crosspoint across temp and voltage ranges.
9. Duty cycle skew is measured between differential outputs using the deviations of the sum of  $Tpw-$  and  $Tpw+$ .
10. Skew is measured between outputs under identical transition @ 400 MHz.
11. Additive RMS jitter with 50% duty cycle clock signal using phase noise integrated from 12 KHz to 33 MHz

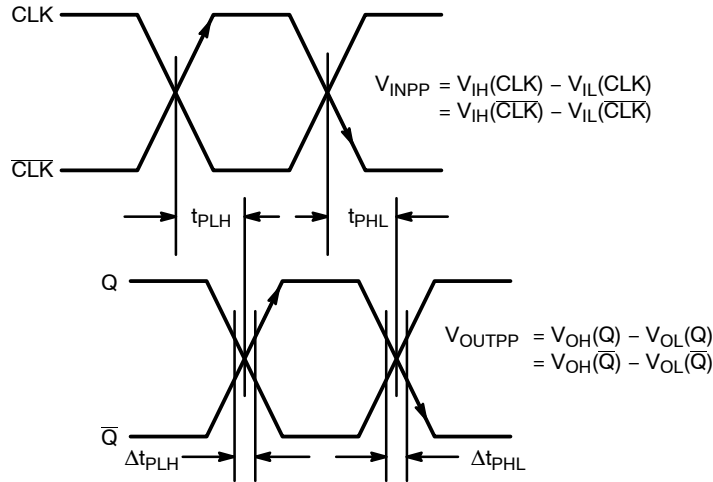

**Figure 3. AC Reference Measurement**

# NB4N111K

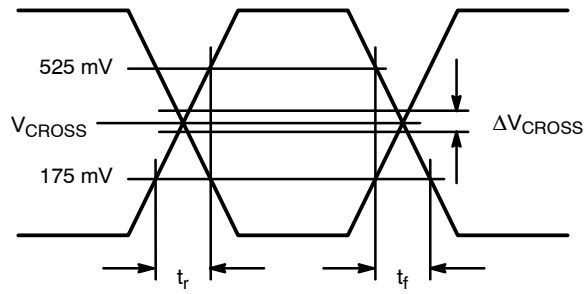

Figure 4. HCSL Output Parameter Characteristics

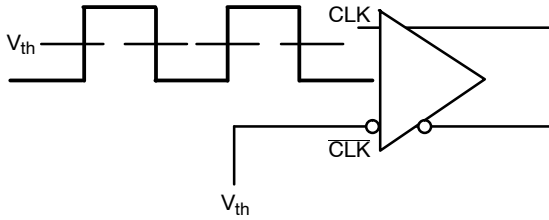

Figure 5. Differential Input Driven Single-Ended ( $V_{th} = V_{REFAC}$ )

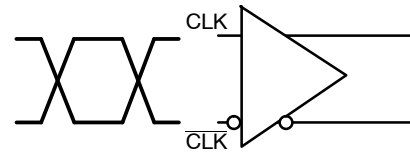

Figure 6. Differential Inputs Driven Differentially

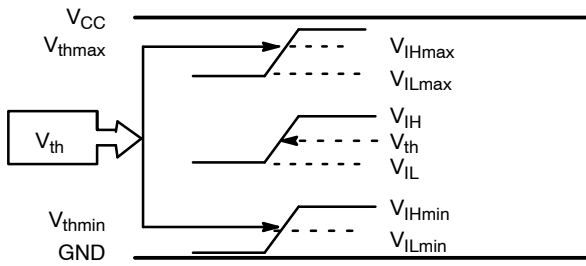

Figure 7.  $V_{th}$  Diagram

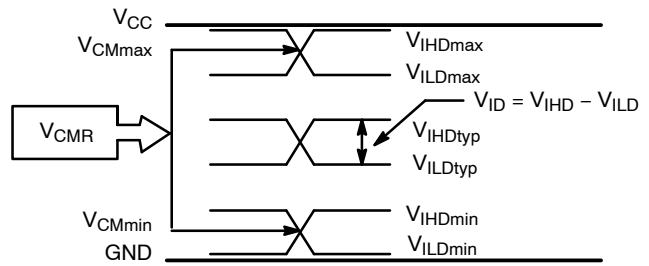

Figure 8.  $V_{CMR}$  Diagram







# NB4N111K

## ORDERING INFORMATION

Device	Package	Shipping†
NB4N111KMNG	QFN32 (Pb-Free)	79 Units / Rail
NB4N111KMNR4G	QFN32 (Pb-Free)	1000 / Tape & Reel

†For information on tape and reel specifications, including part orientation and tape sizes, please refer to our Tape and Reel Packaging Specifications Brochure, BRD8011/D.



Компания «Океан Электроники» предлагает заключение долгосрочных отношений при поставках импортных электронных компонентов на взаимовыгодных условиях!

Наши преимущества:

- Поставка оригинальных импортных электронных компонентов напрямую с производств Америки, Европы и Азии, а так же с крупнейших складов мира;
- Широкая линейка поставок активных и пассивных импортных электронных компонентов (более 30 млн. наименований);
- Поставка сложных, дефицитных, либо снятых с производства позиций;
- Оперативные сроки поставки под заказ (от 5 рабочих дней);
- Экспресс доставка в любую точку России;
- Помощь Конструкторского Отдела и консультации квалифицированных инженеров;
- Техническая поддержка проекта, помощь в подборе аналогов, поставка прототипов;
- Поставка электронных компонентов под контролем ВП;
- Система менеджмента качества сертифицирована по Международному стандарту ISO 9001;
- При необходимости вся продукция военного и аэрокосмического назначения проходит испытания и сертификацию в лаборатории (по согласованию с заказчиком);
- Поставка специализированных компонентов военного и аэрокосмического уровня качества (Xilinx, Altera, Analog Devices, Intersil, Interpoint, Microsemi, Actel, Aeroflex, Peregrine, VPT, Syfer, Eurofarad, Texas Instruments, MS Kennedy, Miteq, Cobham, E2V, MA-COM, Hittite, Mini-Circuits, General Dynamics и др.);

Компания «Океан Электроники» является официальным дистрибьютором и эксклюзивным представителем в России одного из крупнейших производителей разъемов военного и аэрокосмического назначения «JONHON», а так же официальным дистрибьютором и эксклюзивным представителем в России производителя высокотехнологичных и надежных решений для передачи СВЧ сигналов «FORSTAR».



## JONHON

«JONHON» (основан в 1970 г.)

Разъемы специального, военного и аэрокосмического назначения:

(Применяются в военной, авиационной, аэрокосмической, морской, железнодорожной, горно- и нефтедобывающей отраслях промышленности)

«FORSTAR» (основан в 1998 г.)

ВЧ соединители, коаксиальные кабели, кабельные сборки и микроволновые компоненты:

(Применяются в телекоммуникациях гражданского и специального назначения, в средствах связи, РЛС, а так же военной, авиационной и аэрокосмической отраслях промышленности).



Телефон: 8 (812) 309-75-97 (многоканальный)

Факс: 8 (812) 320-03-32

Электронная почта: [ocean@oceanchips.ru](mailto:ocean@oceanchips.ru)

Web: <http://oceanchips.ru/>

Адрес: 198099, г. Санкт-Петербург, ул. Калинина, д. 2, корп. 4, лит. А