

Analog Devices Welcomes Hittite Microwave Corporation

NO CONTENT ON THE ATTACHED DOCUMENT HAS CHANGED



THIS PAGE INTENTIONALLY LEFT BLANK



GaAs pHEMT MMIC LOW NOISE AMPLIFIER, 6 - 17 GHz

Typical Applications

This HMC903LP3E is ideal for:

- Point-to-Point Radios
- Point-to-Multi-Point Radios
- Military & Space
- Test Instrumentation

Features

- Low Noise Figure: 1.7 dB
- High Gain: 18 dB
- P1dB Output Power: 14 dBm
- Single Supply Voltage: +3.5 V @ 80 mA
- Output IP3: +25 dBm
- 50 Ohm matched Input/Output
- 16 Lead 3x3mm SMT Package: 9mm²

Functional Diagram

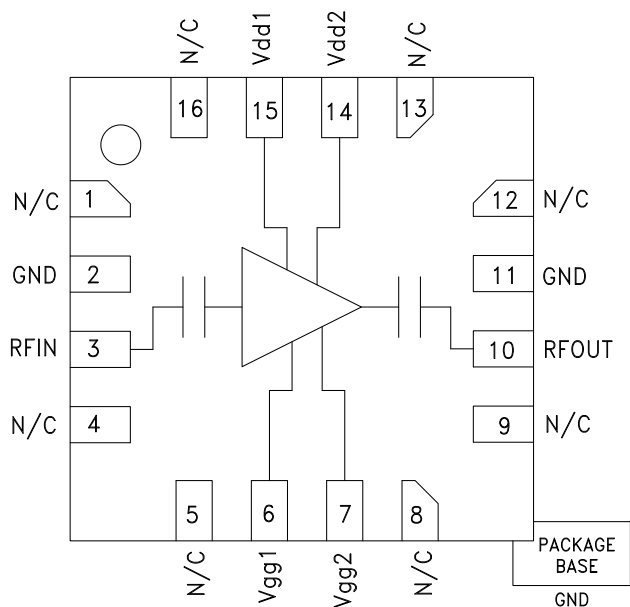

General Description

The HMC903LP3E is a self-biased GaAs MMIC Low Noise Amplifier housed in a leadless 3x3 mm plastic surface mount package. The amplifier operates between 6 and 17 GHz, providing 18 dB of small signal gain, 1.7 dB noise figure, and output IP3 of +25 dBm, while requiring only 80 mA from a +3.5 V supply. The P1dB output power of +14 dBm enables the LNA to function as a LO driver for balanced, I/Q or image reject mixers. The HMC903LP3E also features I/Os that are DC blocked and internally matched to 50 Ohms, making it ideal for high capacity microwave radios and VSAT applications.

Electrical Specifications, $T_A = +25^\circ\text{C}$, $V_{dd1} = V_{dd2} = +3.5\text{V}$, $I_{dd} = 80\text{ mA}$ [2]

Parameter	Min.	Typ.	Max.	Min.	Typ.	Max.	Units
Frequency Range	6 - 16		16 - 17				GHz
Gain [1]	16.5	18.5		15	18		dB
Gain Variation over Temperature		0.012			0.012		dB / °C
Noise Figure [1]		1.7	2.2		2.2	2.5	dB
Input Return Loss		12			11		dB
Output Return Loss		12			14		dB
Output Power for 1 dB Compression [1]	13	14.5		12	13		dBm
Saturated Output Power (P _{sat}) [1]		16.5			16.5		dBm
Output Third Order Intercept (IP3)	22	25		22	25		dBm
Supply Current (I _{dd}) (V _{dd} = 3.5V, V _{gg1} = V _{gg2} = Open)		80	110		80	110	mA

[1] Board loss removed from gain, power and noise figure measurement.

[2] V_{gg1} = V_{gg2} = Open for normal, self-biased operation

Broadband Gain & Return Loss [1]

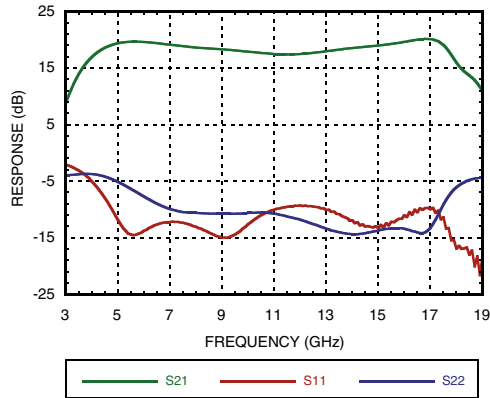

Gain vs. Temperature [1]

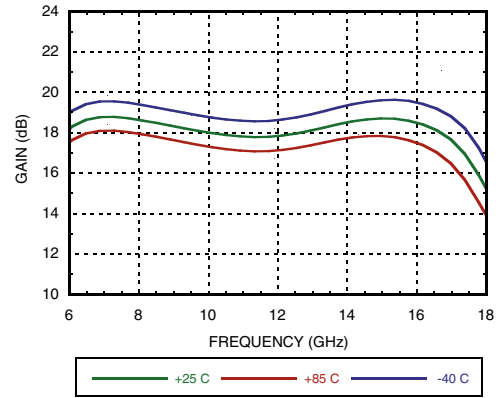

Input Return Loss vs. Temperature

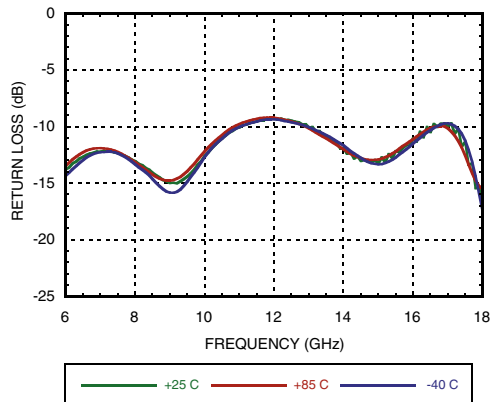

Output Return Loss vs. Temperature

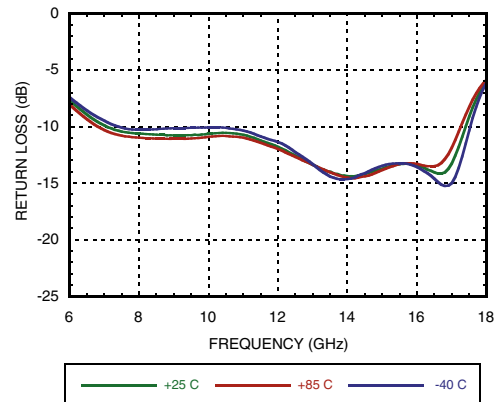

Noise Figure vs. Temperature [1]

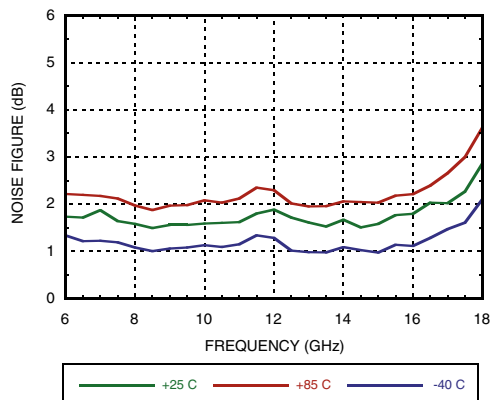

Output IP3 vs. Temperature

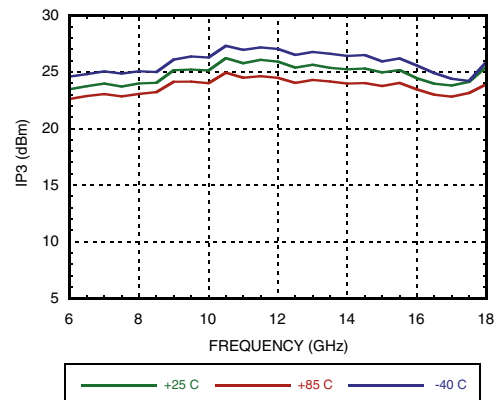

[1] Board loss removed from gain, power and noise figure measurement.



GaAs pHEMPT MMIC LOW NOISE AMPLIFIER, 6 - 17 GHz

AMPLIFIER - LOW NOISE - SMT

P1dB vs. Temperature [1]

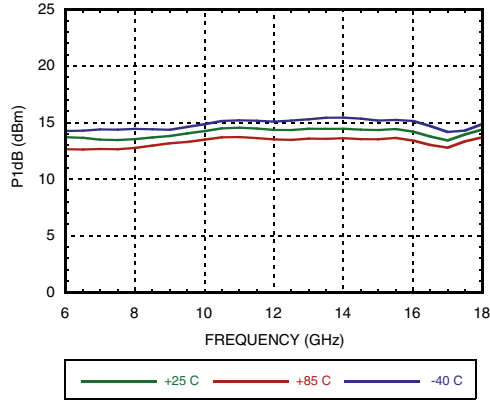

Psat vs. Temperature [1]

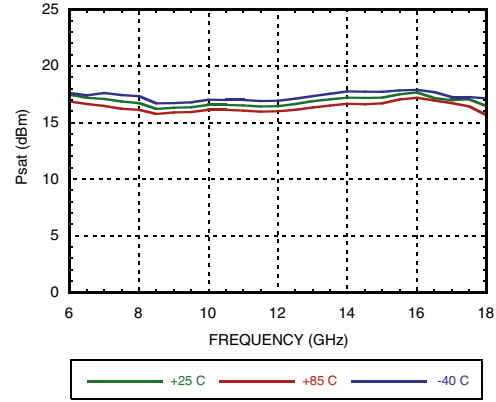

Reverse Isolation vs. Temperature

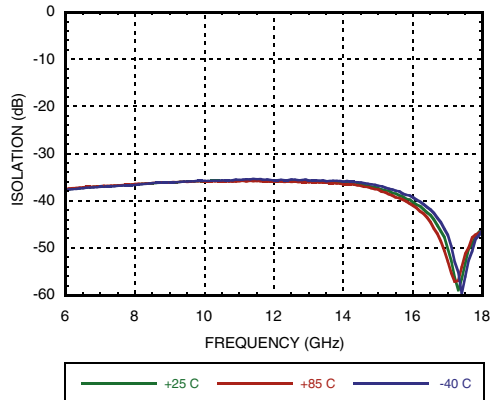

Power Compression @ 12 GHz [1]

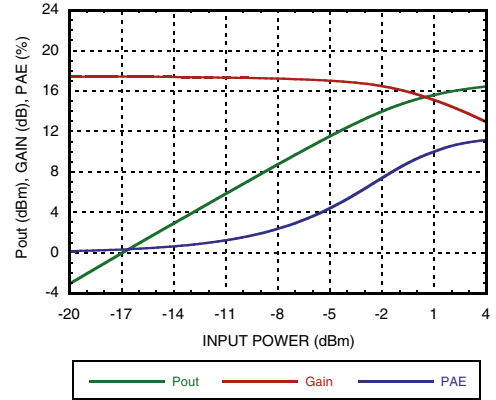

Gain, Noise Figure & Power vs. Supply Voltage @ 12 GHz [1]

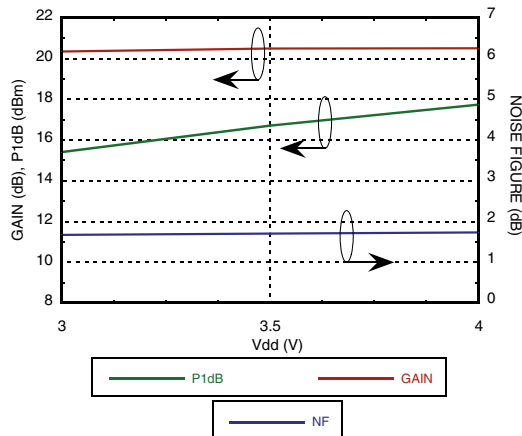

Gain, Output IP3 & Idd vs. Gate Voltage @ 12 GHz [2][3]

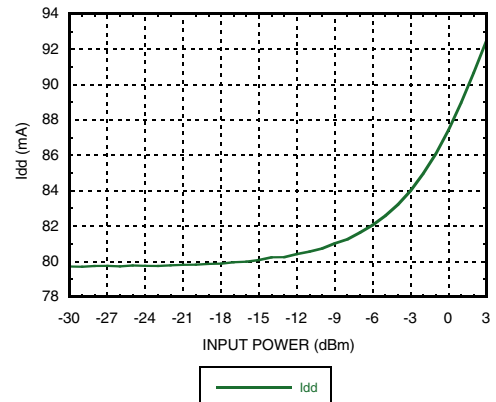

[1] Board loss removed from gain, power and noise figure measurement.

[2] Board loss removed from gain measurement

[3] Data taken at Vdd1 = Vdd2 = 3V



GaAs pHEMPT MMIC LOW NOISE AMPLIFIER, 6 - 17 GHz

Current vs. Input Power @ 12 GHz

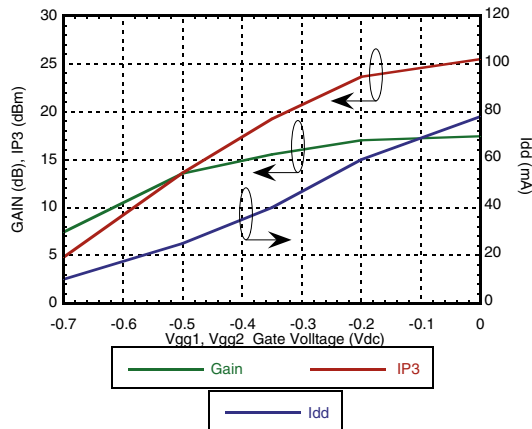

Absolute Maximum Ratings

Drain Bias Voltage	+4.5V
RF Input Power	+10 dBm
Gate Bias Voltage, Vgg1	-0.8V to +0.2V
Gate Bias Voltage, Vgg2	-0.8V to +0.2V
Channel Temperature	150 °C
Continuous P _{diss} (T = 85 °C) (derate 6.9 mW/°C above 85 °C)	0.45 W
Thermal Resistance (Channel to ground paddle)	144.8 °C/W
Storage Temperature	-65 to +150 °C
Operating Temperature	-40 to +85 °C
ESD Sensitivity (HBM)	Class 0, Passed 150V



ELECTROSTATIC SENSITIVE DEVICE
OBSERVE HANDLING PRECAUTIONS

Outline Drawing

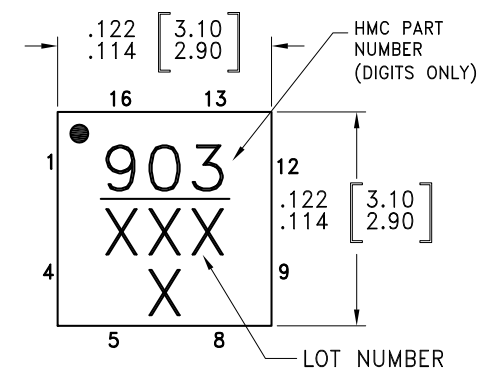

BOTTOM VIEW

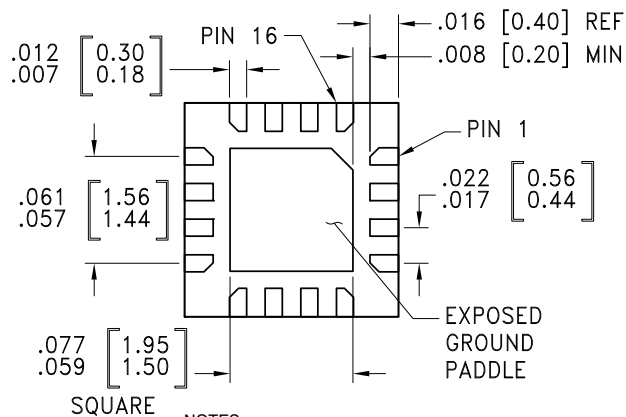

NOTES:

1. PACKAGE BODY MATERIAL: LOW STRESS INJECTION MOLDED PLASTIC SILICA AND SILICON IMPREGNATED.
2. LEAD AND GROUND PADDLE MATERIAL: COPPER ALLOY.
3. LEAD AND GROUND PADDLE PLATING: 100% MATTE TIN
4. DIMENSIONS ARE IN INCHES [MILLIMETERS].
5. LEAD SPACING TOLERANCE IS NON-CUMULATIVE.
6. PAD BURR LENGTH SHALL BE 0.15mm MAX. PAD BURR HEIGHT SHALL BE 0.05mm MAX.
7. PACKAGE WARP SHALL NOT EXCEED 0.05mm
8. ALL GROUND LEADS AND GROUND PADDLE MUST BE SOLDERED TO PCB RF GROUND.
9. REFER TO HITTITE APPLICATION NOTE FOR SUGGESTED PCB LAND PATTERN.

Package Information

Part Number	Package Body Material	Lead Finish	Package Marking ^[1]
HMC903LP3E	RoHS-compliant Low Stress Injection Molded Plastic	100% matte Sn ^[2]	903 XXXX

[1] 4-Digit lot number XXXX

[2] Max peak reflow temperature of 260 °C



**GaAs pHEMPT MMIC LOW NOISE AMPLIFIER,
6 - 17 GHZ**

Pin Descriptions

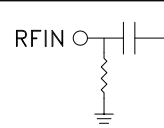
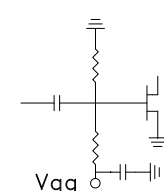
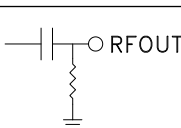
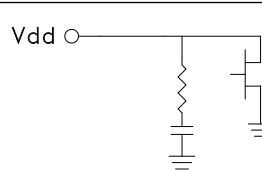
Pin Number	Function	Description	Interface Schematic
1, 4, 5, 8, 9, 12, 13, 16	N/C	The pins are not connected internally; however, all data shown herein was measured with these pins connected to RF/DC ground externally.	
2, 11	GND	Package bottom has exposed metal ground paddle that must be connected to RF/DC ground.	
3	RFIN	This pin is AC coupled and matched to 50 Ohms	
6, 7	Vgg1, Vgg2	Optional gate control for amplifier. If left open, the amplifier will run self-biased at standard current. Negative voltage applied will reduce drain current. External capacitors required, see application circuits herein.	
10	RFOUT	This pin is AC coupled and matched to 50 Ohms	
14, 15	Vdd2, Vdd1	Power supply voltage for the amplifier. See assembly for required external components.	



GaAs pHEMPT MMIC LOW NOISE AMPLIFIER, 6 - 17 GHZ

Evaluation PCB

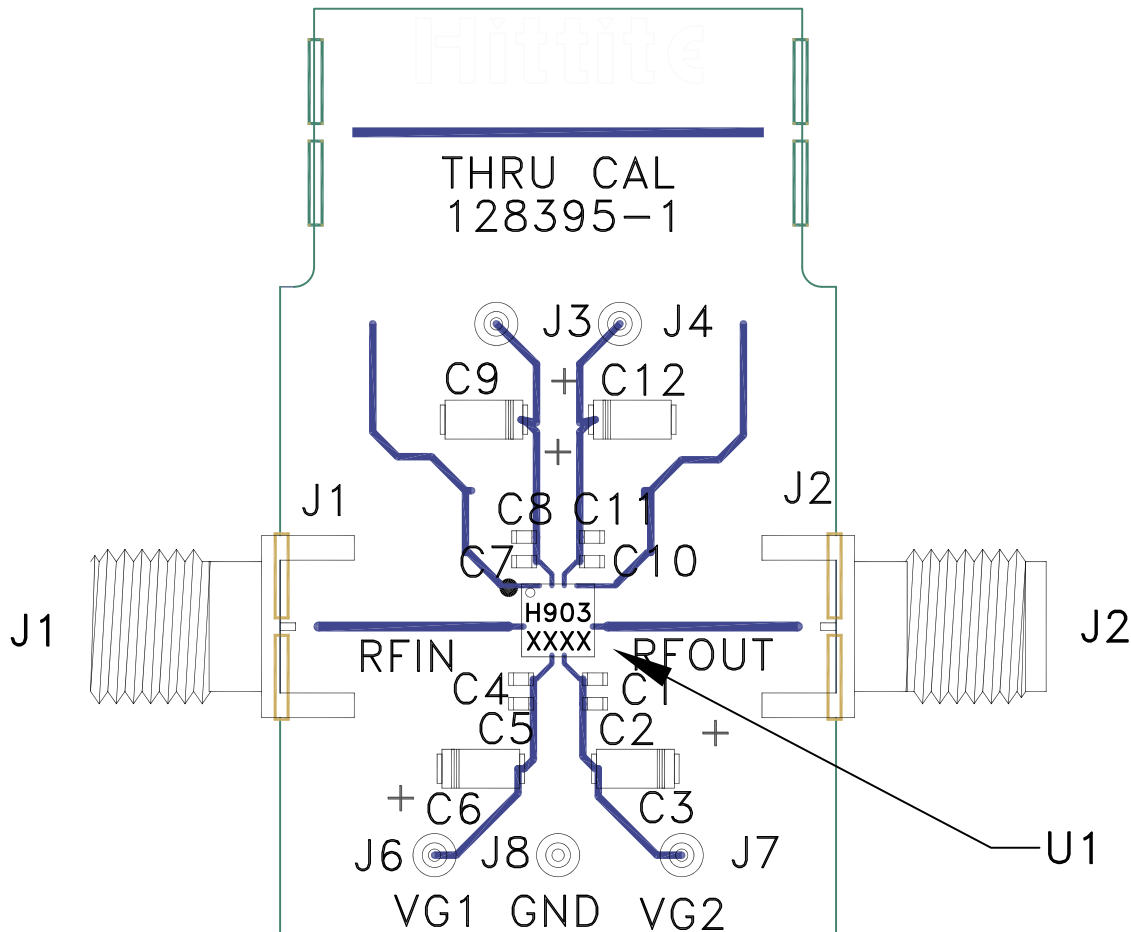

List of Material for Evaluation PCB 129798 [1]

Item	Description
J1, J2	SMA Connector
J3, J4, J6 - J8	DC Pins
C1, C4, C7, C10	100 pF Capacitor, 0402 Pkg.
C2, C5, C8, C11	10 KpF Capacitor, 0402 Pkg.
C3, C6, C9, C12	4.7 μ F Capacitor, Tantalum
U1	HMC903LP3E Amplifier
PCB [2]	128395 Evaluation PCB

[1] Reference this number when ordering complete evaluation PCB

[2] Circuit Board Material: Rogers 4350 or Arlon 25FR

The circuit board used in this application should use RF circuit design techniques. Signal lines should have 50 Ohm impedance while the package ground leads and exposed paddle should be connected directly to the ground plane similar to that shown. A sufficient number of via holes should be used to connect the top and bottom ground planes. The evaluation board should be mounted to an appropriate heat sink. The evaluation circuit board shown is available from Hittite upon request.

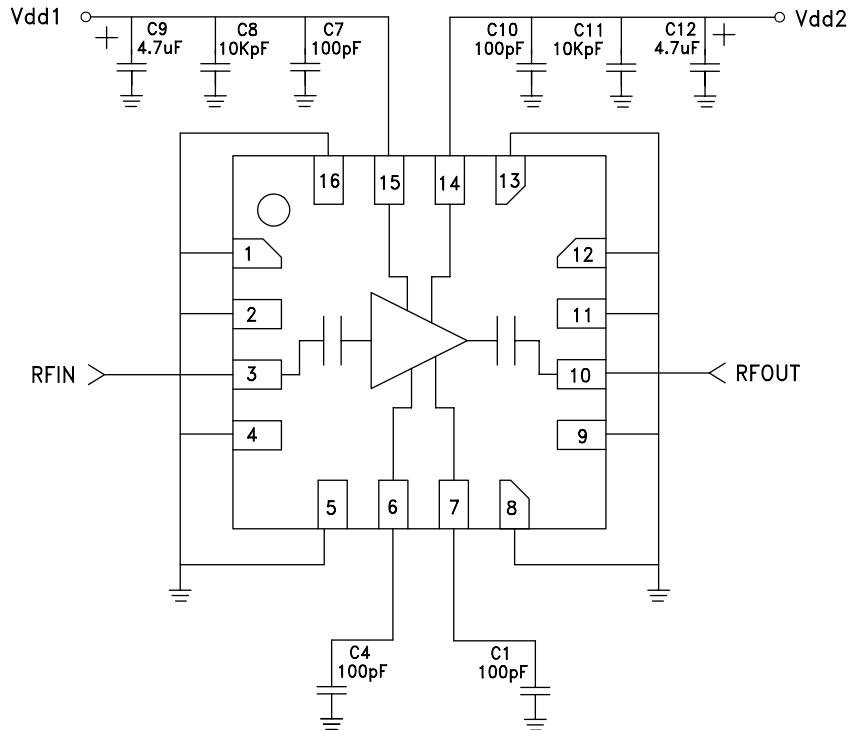
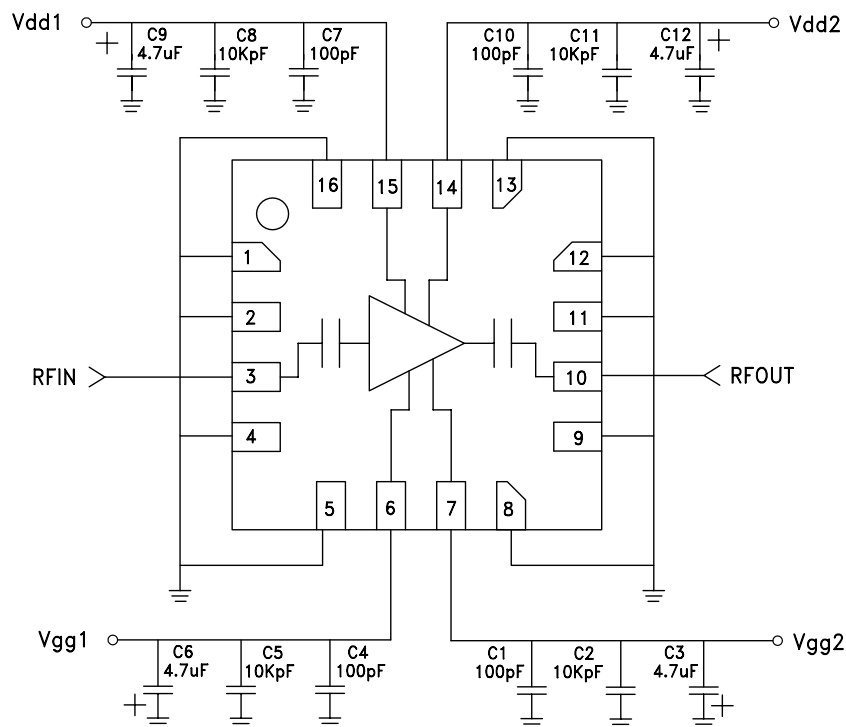
**GaAs pHEMPT MMIC LOW NOISE AMPLIFIER,
6 - 17 GHZ**
Application Circuit - Standard (Self-Biased) Operation

Application Circuit - Gate Control, Reduced Current Operation



**GaAs pHEMPT MMIC LOW NOISE AMPLIFIER,
6 - 17 GHZ**

Notes:

Компания «Океан Электроники» предлагает заключение долгосрочных отношений при поставках импортных электронных компонентов на взаимовыгодных условиях!

Наши преимущества:

- Поставка оригинальных импортных электронных компонентов напрямую с производств Америки, Европы и Азии, а так же с крупнейших складов мира;
- Широкая линейка поставок активных и пассивных импортных электронных компонентов (более 30 млн. наименований);
- Поставка сложных, дефицитных, либо снятых с производства позиций;
- Оперативные сроки поставки под заказ (от 5 рабочих дней);
- Экспресс доставка в любую точку России;
- Помощь Конструкторского Отдела и консультации квалифицированных инженеров;
- Техническая поддержка проекта, помощь в подборе аналогов, поставка прототипов;
- Поставка электронных компонентов под контролем ВП;
- Система менеджмента качества сертифицирована по Международному стандарту ISO 9001;
- При необходимости вся продукция военного и аэрокосмического назначения проходит испытания и сертификацию в лаборатории (по согласованию с заказчиком);
- Поставка специализированных компонентов военного и аэрокосмического уровня качества (Xilinx, Altera, Analog Devices, Intersil, Interpoint, Microsemi, Actel, Aeroflex, Peregrine, VPT, Syfer, Eurofarad, Texas Instruments, MS Kennedy, Miteq, Cobham, E2V, MA-COM, Hittite, Mini-Circuits, General Dynamics и др.);

Компания «Океан Электроники» является официальным дистрибьютором и эксклюзивным представителем в России одного из крупнейших производителей разъемов военного и аэрокосмического назначения «JONHON», а так же официальным дистрибьютором и эксклюзивным представителем в России производителя высокотехнологичных и надежных решений для передачи СВЧ сигналов «FORSTAR».



JONHON

«JONHON» (основан в 1970 г.)

Разъемы специального, военного и аэрокосмического назначения:

(Применяются в военной, авиационной, аэрокосмической, морской, железнодорожной, горно- и нефтедобывающей отраслях промышленности)

«FORSTAR» (основан в 1998 г.)

ВЧ соединители, коаксиальные кабели,
кабельные сборки и микроволновые компоненты:

(Применяются в телекоммуникациях гражданского и специального назначения, в средствах связи, РЛС, а так же военной, авиационной и аэрокосмической отраслях промышленности).



Телефон: 8 (812) 309-75-97 (многоканальный)

Факс: 8 (812) 320-03-32

Электронная почта: ocean@oceanchips.ru

Web: <http://oceanchips.ru/>

Адрес: 198099, г. Санкт-Петербург, ул. Калинина, д. 2, корп. 4, лит. А