

A165S/W

Separate Construction with Cylindrical 16-dia. Body

- Same separate construction as the A16-series Pushbuttons with Miniature Design of 28.5 mm
- The same contacts can be used for both standard loads and microloads.
- Oil-resistant IP65 models
- Conforms to EN60947-5-1.



 Refer to *Safety Precautions for All Pushbutton Switches/ Indicators* and *Safety Precautions* on page 15.

List of Models

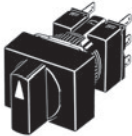
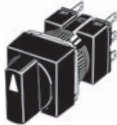
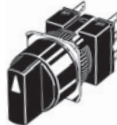
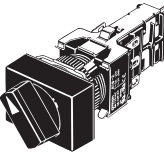
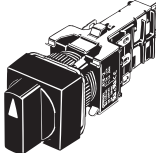
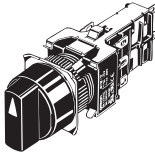
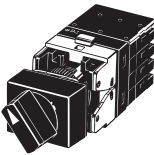
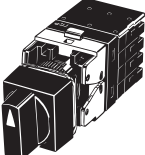
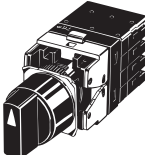
	Model		
	Rectangular	Square	Round
Solder terminals	 A165□-J Series	 A165□-A Series	 A165□-T Series
Voltage-reduction lighting	 A165□-J Series	 A165□-A Series	 A165□-T Series
Screw-less clamp connector	 A165□-J Series	 A165□-A Series	 A165□-T Series

Model Number Structure

Model Number Legend The model numbers used to order sets of Units are illustrated below. One set comprises the Selector, Lamp (lighted models only), and Switch.
For information on combinations, refer to *Ordering Information* on page 3.

(1) (2) (3) (4) (5) (6)
A 1 6 5 W - A 2 A R - 2 4 D - 1

(1) Lighted/ Non-lighted

Symbol	Type
S	Non-lighted
W	Lighted

(2) Shape of Selector

Symbol	Shape
J	Rectangular
A	Square
T	Round

(3) Number of Notches/ Resetting Method

Symbol	No. of notches	Reset method
2M	2 notches	Manual ↓
		Automatic ◇
3M	3 notches	Manual ↓
		Automatic ◇

(4) Color of Selector

Symbol	Color
No symbol	Black (non-lighted models only)
R	Red
G	Green
Y	Yellow

(6) Contact Configuration

Symbol	Type	Terminal
1	SPDT	Solder terminal
2	DPDT	
1P	SPDT	PCB terminal
2P	DPDT	
2S	DPDT	Screw-less Clamp

Note: 1. Only DPDT contacts are available with 3-notch models and Screw-less Clamp models.
2. PCB terminals are available only with 2-notch models.

(5) Light Source

Symbol	Type
No symbol	Non-lighted
24D	24-V LED

Voltage Reduction Unit (24-V Built-in LED)

Symbol	Type	Operating voltage	Rated voltage
T1	LED	100/110 VAC/VDC	110 VAC/VDC
T2		200/220 VAC/VDC	220 VAC/VDC

Note: 1. Solder terminals are only available with 100-V models.
2. The Voltage Reduction Unit is not available for models with PCB terminals.
3. "T2" is available only for the Screw-less Clamp type.

Ordering Information

Ordering as a Set The model numbers used to order sets of Units are given in the following tables. One set comprises the Selector, Lamp (lighted models only), and Switch.

Solder Terminals

Rectangular



A165□-J

Oil-resistant IP65

No. of notches	Output	Reset method	Lighting method	Model
2 notches	SPDT	Manual	LED	A165W-J2M□-24D-1
			Non-lighted	A165S-J2M-1
		Automatic	LED	A165W-J2A□-24D-1
			Non-lighted	A165S-J2A-1
	DPDT	Manual	LED	A165W-J2M□-24D-2
			Non-lighted	A165S-J2M-2
3 notches	DPDT	Automatic	LED	A165W-J2A□-24D-2
			Non-lighted	A165S-J2A-2
		Manual	LED	A165W-J3M□-24D-2
			Non-lighted	A165S-J3M-2

Note: Enter the desired color symbol for the Selector in □: R (red); Y (yellow); G (green). The Selector for non-lighted models is black.

Square



A165□-A

Oil-resistant IP65

No. of notches	Output	Reset method	Lighting method	Model
2 notches	SPDT	Manual	LED	A165W-A2M□-24D-1
			Non-lighted	A165S-A2M-1
		Automatic	LED	A165W-A2A□-24D-1
			Non-lighted	A165S-A2A-1
	DPDT	Manual	LED	A165W-A2M□-24D-2
			Non-lighted	A165S-A2M-2
3 notches	DPDT	Automatic	LED	A165W-A2A□-24D-2
			Non-lighted	A165S-A2A-2
		Manual	LED	A165W-A3M□-24D-2
			Non-lighted	A165S-A3M-2

Note: Enter the desired color symbol for the Selector in □: R (red); Y (yellow); G (green). The Selector for non-lighted models is black.

Round

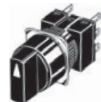

A165□-T

Oil-resistant IP65

No. of notches	Output	Reset method	Lighting method	Model
2 notches	SPDT	Manual	LED	A165W-T2M□-24D-1
			Non-lighted	A165S-T2M-1
		Automatic	LED	A165W-T2A□-24D-1
			Non-lighted	A165S-T2A-1
	DPDT	Manual	LED	A165W-T2M□-24D-2
			Non-lighted	A165S-T2M-2
3 notches	DPDT	Automatic	LED	A165W-T2A□-24D-2
			Non-lighted	A165S-T2A-2
		Manual	LED	A165W-T3M□-24D-2
			Non-lighted	A165S-T3M-2

Note: Enter the desired color symbol for the Selector in □: R (red); Y (yellow); G (green). The Selector for non-lighted models is black.

Ordering Information

Ordering Individually Selectors, Lamps, and Switches (Sockets) can be ordered separately. Combinations that are not available as sets can be created using individual Units. Also, store the parts as spares for maintenance and repairs.

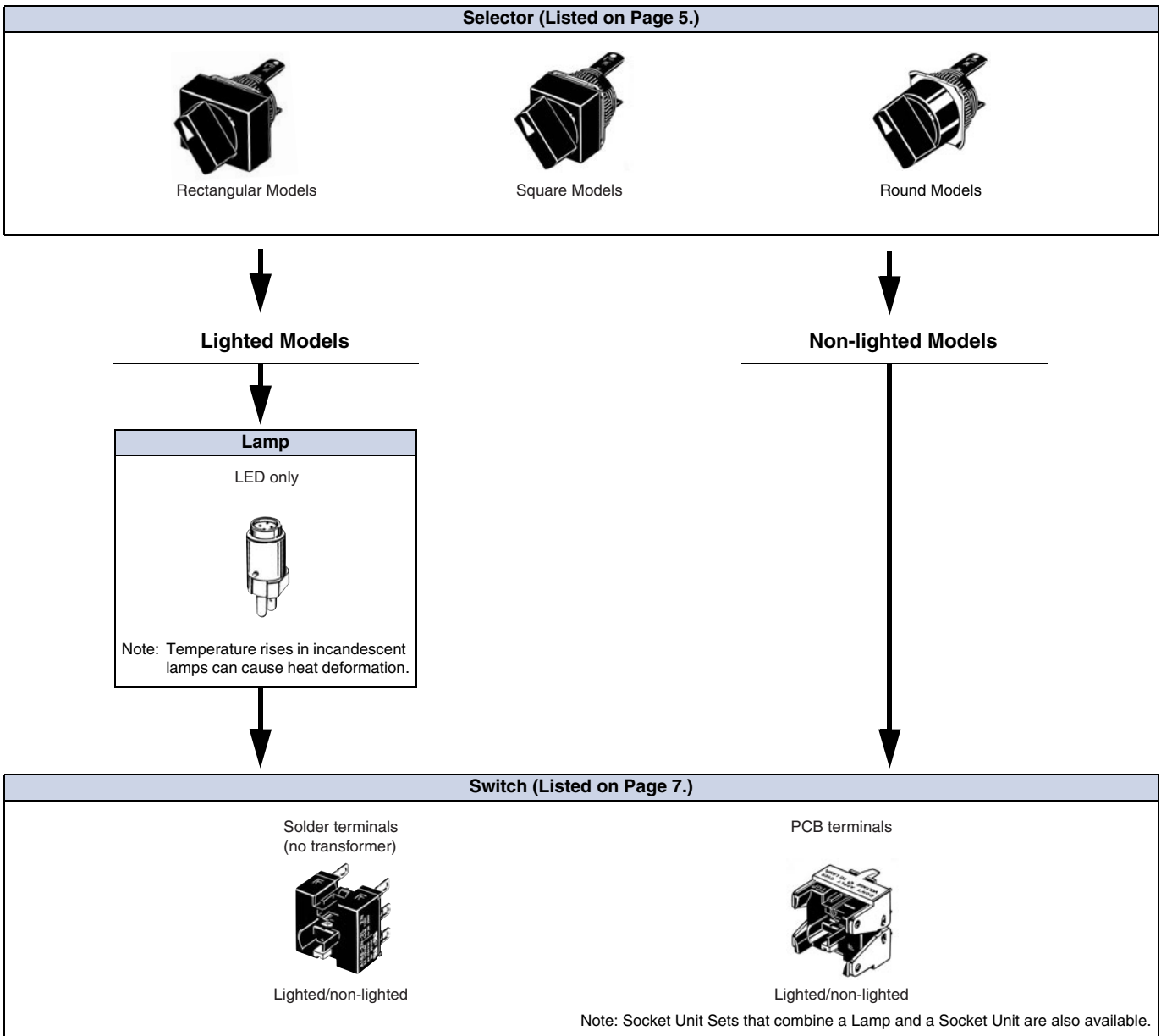

Ordering Information

Ordering Individually Selectors, Lamps, and Switches (Sockets) can be ordered separately. Combinations that are not available as sets can be created using individual Units. Also, store the parts as spares for maintenance and repairs.

Selectors (Oil-resistant IP65 Models Only)

Appearance	Number of notches	Reset method	Lighting method	Model	Selector color symbol
Rectangular (A165□-J) 	2 notches	Manual	LED	A165W-J2M□	Enter the desired color symbol for the Selector in □. R (red), Y (yellow), G (green)
			Non-lighted	A165S-J2M	
		Automatic 	LED	A165W-J2A□	
	3 notches	Manual	Non-lighted	A165S-J2A	
			LED	A165W-J3M□	
		Fully automatic 	LED	A165W-J3A□	
Square (A165□-A) 	2 notches	Manual	LED	A165W-A2M□	Enter the desired color symbol for the Selector in □. R (red), Y (yellow), G (green)
			Non-lighted	A165S-A2M	
		Automatic 	LED	A165W-A2A□	
	3 notches	Manual	Non-lighted	A165S-A2A	
			LED	A165W-A3M□	
		Fully automatic 	LED	A165W-A3A□	
Round (A165□-T) 	2 notches	Manual	LED	A165W-T2M□	Enter the desired color symbol for the Selector in □. R (red), Y (yellow), G (green)
			Non-lighted	A165S-T2M	
		Automatic 	LED	A165W-T2A□	
	3 notches	Manual	Non-lighted	A165S-T2A	
			LED	A165W-T3M□	
		Fully automatic 	LED	A165W-T3A□	
		Non-lighted	A165S-T3A		

Note: The selector for non-lighted models is black.

Ordering Information

Sets Select an Operation Unit and a Socket Unit Set (Lamp and Socket Unit).

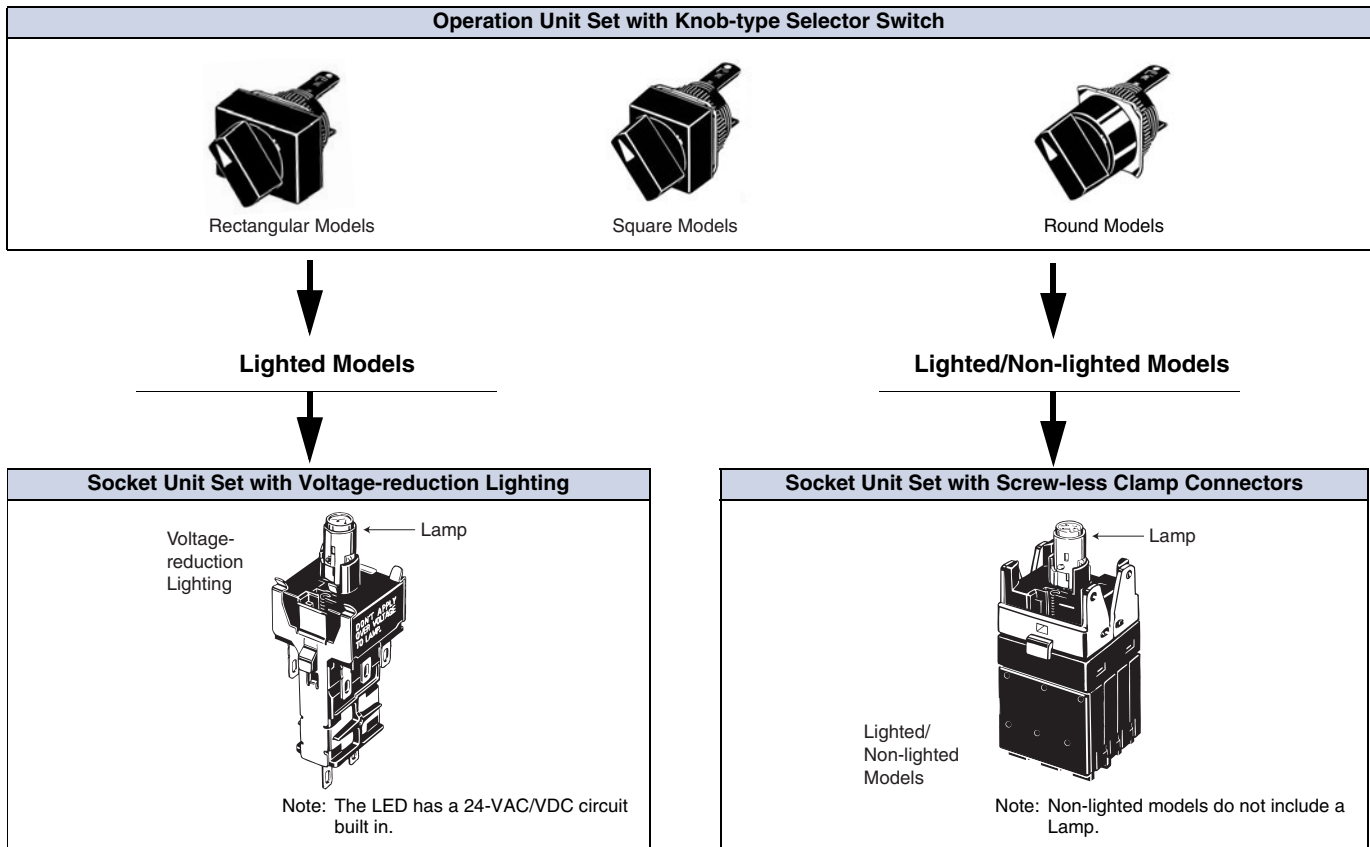

Socket Unit Set (Sets include a Socket Unit and a Lamp.)

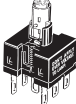
Appearance	Number of notches	Classification		Model	
	2 notches	SPDT	24 V	Solder terminals	A16W-2N□-24D-1
		DPDT			A16W-2N□-24D-2
	3 notches	DPDT			A16W-3N□-24D-2

Socket Unit Set with Voltage Reduction Unit (Solder Terminal)

Appearance	Classification		Operating voltage	Model
	Standard loads and microloads	2 notches	SPDT	A16L-□-T1-1
		2 notches	DPDT	A16L-□-T1-2
		3 notches		A16W-3N□-T1-2

Note: The LED has a 24-VAC/VDC circuit built in.

Insert one of the following letters into the box (□).

Symbol	Light color
R	Red
Y	Yellow
G	Green

Ordering Information

Screw-less Clamp Connector Socket Unit Set

Appearance	Classification			Model	Remarks	
	Standard loads and microloads	2 notches DPDT	Non-lighted		A16-2S	Used for Pushbutton Switches and Knob-type Selector Switches.
			Lighted	No voltage-reduction lighting		
		Voltage-reduction lighting		100/110 VAC/VDC	A16L-Δ-T1-2S	
			200/220 VAC/VDC	A16L-Δ-T2-2S		
	3 notches DPDT	Non-lighted	No voltage-reduction lighting		A16S-3N-2LS	
			Lighted	No voltage-reduction lighting		
		Voltage-reduction lighting		100/110 VAC/VDC	A16W-3N-Δ-T1-2S	
			200/220 VAC/VDC	A16W-3N-Δ-T2-2S		

Note: The 100-V models and 200-V models have a 24-VAC/VDC circuit built in.

Insert symbols in Δ and □.

Δ

Symbol	Light color
R	Red
Y	Yellow
G	Green

□

Symbol	Type	Operating voltage
5D	LED	5 VDC
12D		12 VAC/VDC
24D		24 VAC/VDC

Ordering Individually Switches

Appearance	Classification			Model			
	Lighted	Socket (without voltage-reduction lighting)	2 notches	SPDT	Solder terminal	A16S-2N-1L	
			3 notches	DPDT		A16S-2N-2L	
	Non-lighted		2 notches	SPDT		A16S-2N-1	
			3 notches	DPDT		A16S-2N-2	
	Lighted	Socket (without voltage-reduction lighting)	2 notches	SPDT		PCB terminal	A16S-2N-1LP
			3 notches	DPDT			A16S-2N-2LP
	Non-lighted		2 notches	SPDT			A16S-2N-1P
			3 notches	DPDT			A16S-2N-2P

Lamps

Operating voltage	Super-bright 		
Light color	5 VDC	12 VAC/VDC	24 VAC/VDC
Red	A16-5DSR	A16-12DSR	A16-24DSR
Yellow	A16-5DSY	A16-12DSY	A16-24DSY
Green	A16-5DSG	A16-12DSG	A16-24DSG

Accessories and Tools (Order Separately)

Accessories

Name	Appearance	Classification	Model	Remarks
Panel Plugs		Rectangular	A16ZJ-3003	Used for covering the panel cut-outs for future panel expansion. Degree of protection: IP40
		Square	A16ZA-3003	
		Round	A16ZT-3003	

Tools

Name	Appearance	Model	Applicable types					Remarks
			Pushbutton Switch	Knob-type Selector Switch	Key-type Selector Switch	Emergency Stop Switch	Indicator	
Screw Fitting		A16Z-3004	Yes	Yes	Yes	Yes	Yes	Convenient for ganged installation. Tighten to a torque of 0.39 N·m min.
Extractor		A16Z-5080	Yes	Yes	Yes	Yes	Yes	Convenient for extracting the Switches and Lamps.

Ordering as a Set: Refer to page 3.

- Specifications and dimensions: Refer to pages 8 to 10.
- Accessories, replacements, and tools: Refer to this page

Specifications

Approved Standard Ratings

UL, cUL (File No. E41515)

5 A at 125 VAC, 3 A at 250 VAC (general use)
3 A at 30 VDC (resistive)

Note: Certification has been obtained for the Socket Unit.
For detailed information on individual products that have received certification, consult your supplier.

TÜV (EN60947-5-1) (Low Voltage Directive)

3 A at 250 VAC
3 A at 30 VDC

CCC (GB14048.5)

5 A at 125 VAC
3 A at 250 VAC
3 A at 30 VDC

Ratings

Switch Ratings

Rated voltage	Resistive load
125 VAC	5 A
250 VAC	3 A
30 VDC	3 A

Minimum applicable load: 1 mA at 5 VDC

Rated values are obtained from tests conducted under the following conditions.

1. Load: Resistive load
2. Mounting conditions: No vibration and no shock
3. Temperature: 20±2°C
4. Operating frequency: 20 times/min

Characteristics

Socket Unit

Item	Type	Knob-type Selector Switch
Allowable operating frequency	Mechanical	20 operations/minute max.
	Electrical	10 operations/minute max.
Insulation resistance		100 MΩ min. (at 500V DC)
Contact resistance		100 mΩ max. (initial value)
Dielectric strength	Between terminals of same polarity	1,000 VAC, 50/60 Hz for 1 min
	Between terminals of different polarity	2,000 VAC, 50/60 Hz for 1 min
	Between each terminal and ground	2,000 VAC, 50/60 Hz for 1 min
	Between lamp terminals	1,000 VAC, 50/60 Hz for 1 min*
Vibration resistance	Malfunction	10 to 55 Hz, 1.5-mm double amplitude (malfunction within 1 ms)
Shock resistance	Destruction	500 m/s ² max.
	Malfunction	150 m/s ² max. (malfunction within 1 ms)
Durability	Mechanical	250,000 operations min.
	Electrical	100,000 operations min.
Electric shock protection class		Class II
PTI (tracking characteristic)		175
Degree of contamination		3 (IEC60947-5-1)
Weight		Approx. 13 g (in the case of a lighted DPDT switch)
Ambient operating temperature		-10°C to 55°C (with no icing or condensation)
Ambient operating humidity		35% to 85%RH
Ambient storage temperature		-25°C to 65°C (with no icing or condensation)

* With LED not mounted.
(Perform testing with the LED not mounted.)

Contact Form

Name	Contact form
SPDT	

Super-bright LED

Rated voltage	Rated current	Operating voltage	Internal limiting resistor
5 VDC	8 mA	5 VDC±5%	Red, yellow: 300 Ω Green: 160 Ω
12 VAC/VDC		12 VAC/VDC±5%	Red, yellow: 1 kΩ Green: 910 Ω
24 VAC/VDC		24 VAC/VDC±5%	2.4 kΩ

Screw-less Clamp

Item	Type	Screw-less Clamp			
Recommended wire size		0.5 mm ² twisted wire or 0.8 mm-dia. solid wire			
Usable wires and tensile strength	Twisted wire	0.3 mm ²	0.5 mm ²	0.75 mm ²	1.25 mm ²
	Solid wire	0.5 mm dia.	0.8 mm dia.	1.0 mm dia.	---
	Tensile strength	10 N	20 N	30 N	40 N
Length of exposed wire		10 ±1 mm			
Compliant standards		JIS C 2811 Terminal Blocks for Industrial Use			

Operating Characteristics

Characteristics	Type	Knob-type Selector Switch	
		2 notches	3 notches
Operating force (OF) max.		0.1 N·m	
Set position (SP)		90±5°	45° ⁺¹⁰ ₀

Specifications

Operation Angle



Note: The angle used for automatic reset is shown in parentheses.
FP: Free Position

Contact Form

No. of notches	Contact form				
	SPDT		DPDT		
	Position	SW	Position	SW2	SW1
2 notches					
3 notches	---				

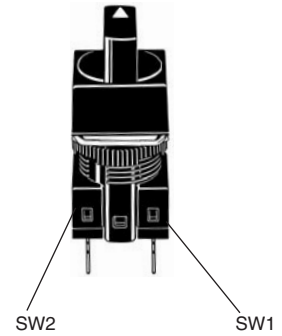

Nomenclature

Model structure



The flange can be rotated to easily change the operation angle of the knob.

For information on rotating the flange, refer to page 14.
Example: Knob-type Selector Switch with Two Notches



(Standard condition when shipped)
Note: The angle is 75° for self-resetting models.

Dimensions

- The Dimension shows 2-switch outputs.
- The lamp terminal is not provided with non-lighted models.

(Unit: mm)

Rectangular A165□-J Solder terminals (tab terminals #110)



Note: See page 12 for panel cutouts.



Square A165□-A Solder terminals (tab terminals #110)



Note: See page 12 for panel cutouts.

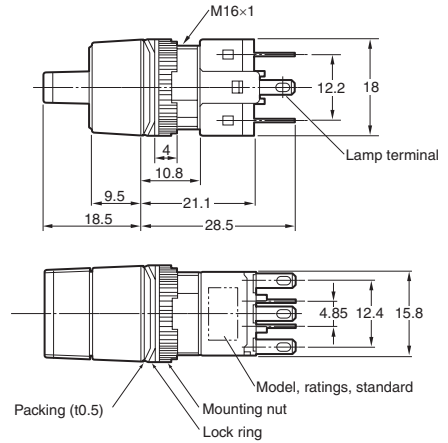

Round A165□-T Solder terminals (tab terminals #110)



Note: See page 12 for panel cutouts.

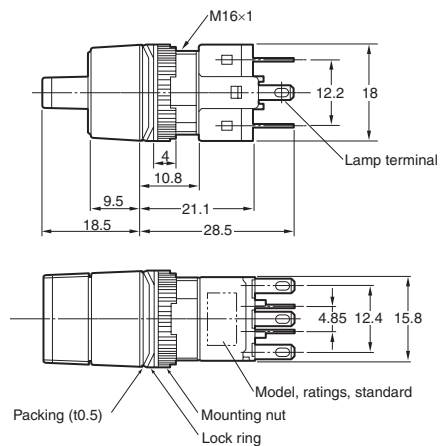

Dimensions

• The Dimension shows 2-switch outputs. • A rectangular model is listed as an example.

(Unit: mm)

Rectangular A165□-J PCB terminals

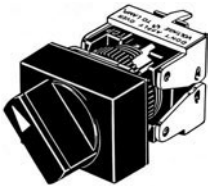

- The lamp terminal is not also provided with non-lighted models.



Note: See page 12 for panel cutouts.



Rectangular A165W□-T Reduced-voltage lighting solder terminals (tab terminals #110)



Panel Cutouts



Rectangular A165□-2S Screw-Less Clamp



- The lamp terminal is also provided with non-lighted models.



Panel Cutouts



Dimensions

Panel Cutouts

Models with Solder Terminals and Models with Screw-less Clamp Connectors

Rectangular A165□-J	Square A165□-A, Round A165□-T
<p>(Top View)</p> 	<p>(Top View)</p> 

- Note: 1. Make sure the thickness of the mounting panel is 0.5 to 3.2 mm.
 2. If the panel is to be finished with coating, etc., make sure that the panel meets the specified dimensions after coating.
 3. Figures in parentheses are for screw-less clamp connectors.

Models with PCB Terminals

Rectangular A165□-J	Square A165□-A, Round A165□-T
<p>(Top View)</p> 	<p>(Top View)</p> 

- Note: 1. Ensure that the variation in the distance between the centers of neighboring mounting holes is less than ± 0.1 mm.
 2. Make sure the thickness of the mounting panel is 0.5 to 3.2 mm. If, however, a Switch Guard or Dust Cover is used, the thickness of the mounting panel must be 0.5 to 2 mm.
 3. If the panel is to be finished with coating, etc., make sure that the panel meets the specified dimensions after coating.

Terminal Arrangement

Models with Solder Terminals without Reduced-voltage Lighting (Lamp terminals are not provided with the Non-lighted Knob-type Selector Switches and Key-type Selector Switches.)

Lighted SPDT Switches	Lighted DPDT Switches
<p>Dimensions of Terminal Holes</p>  <p>Terminal Arrangement (Bottom View)</p>  <p>Note: The L+ is not shown on the Switch.</p>	<p>Dimensions of Terminal Holes</p>  <p>Terminal Arrangement (Bottom View)</p>  <p>Note: The L+ is not shown on the Switch.</p>
Non-lighted SPDT Switches	Non-lighted DPDT Switches
<p>Dimensions of Terminal Holes</p>  <p>Terminal Arrangement (Bottom View)</p> <p>Side with TOP indicated</p> 	<p>Dimensions of Terminal Holes</p>  <p>Terminal Arrangement (Bottom View)</p> <p>Side with TOP indicated</p> 

Dimensions

Models with PCB Terminals



Note: For details of the terminal arrangement for Screw-Less Clamps, refer to the corresponding section for the A16.

Dimensions

Non-lighted Models with PCB Terminals (Lamp terminals are not provided with the Non-lighted Knob-type Selector Switches and Key-type Selector Switches.)

Non-lighted SPDT Switches	Non-lighted DPDT Switches
<p>Dimensions of PCB Terminals</p>  <p>Terminal Arrangement (Bottom View) Side with TOP indicated</p>  <p>PCB Cutouts (Bottom View)</p>  <p>A = 24 min.: Rectangular A = 21 min.: Square/Round L = 24 min. Use t = 1.6 for the PCB.</p> <p>Note: Secure the panel to the board using stud bolts if force will be applied to the board after wiring.</p>	<p>Dimensions of PCB Terminals</p>  <p>Terminal Arrangement (Bottom View) Side with TOP indicated</p>  <p>PCB Cutouts (Bottom View)</p>  <p>A = 24 min.: Rectangular A = 21 min.: Square/Round L = 24 min. Use t = 1.6 for the PCB.</p> <p>Note: Secure the panel to the board using stud bolts if force will be applied to the board after wiring.</p>

For details on mounting the Switch to a panel, and mounting and dismantling the Switch, refer to installation details for the A16 Pushbutton Switch.

Flange Rotation (All Selector Switches)

<p>A165 Knob-type Selector Switch Fix the Switch screw and rotate the flange in 45° turns.</p>  <p>Flange Lock ring Switch screw</p>	<p>A165 Key-type Selector Switch Fix the Switch screw and rotate the flange in 45° turns.</p>  <p>Flange Lock ring Switch screw</p>
--------------------------------------------------------------------------------------------------------------------------------------------------------------------------------------------------------------------------------------------	--------------------------------------------------------------------------------------------------------------------------------------------------------------------------------------------------------------------------------------------

Safety Precautions

Refer to *Safety Precautions for All Pushbutton Switches/Indicators*.

⚠ WARNING

Do not apply a voltage between the incandescent lamp and the terminal that is greater than the rated voltage. If the incandescent lamp is broken, the operating part may pop out.



Always turn OFF the power and wait for 10 minutes before replacing the incandescent lamp. If the lamp is replaced immediately after the power is turned OFF, the remaining heat may cause burns.



Precautions for Correct Use

Mounting

- Always make sure that the power is turned OFF before mounting, removing, or wiring the Switch, or performing maintenance.
- Do not tighten the mounting nut more than necessary using tools such as pointed-nose pliers. Doing so will damage the mounting nut.
The tightening torque is 0.29 to 0.49 N·m.

Wiring

- Solder terminals and quick-connect terminals (#110) are commonly used for terminals.
- Be sure to use electrical wires that are a size appropriate for the applied voltage and carry current (conductor size is 0.5 to 0.75 mm²). Perform soldering according to the conditions provided below. If the soldering is not properly performed, the lead wires will become detached, resulting in short-circuits.
 1. Hand soldering: 350°C, within 3 s
 2. Dip soldering: 350°C, within 3 s
Wait for one minute after soldering before exerting any external force on the solder.
- Use non-corrosive resin fluid as the flux.
- Make sure that the electric cord is wired so that it does not touch the Unit. If the electric cord touches the Unit, then electric wires with a heat resistance of 100°C min. must be used.
- After wiring the Switch, maintain an appropriate clearance and creepage distance.

Operating Environment

- The IP65 model is designed with a degree of protection so that it will not sustain damage if it is subjected to water from any direction to the front of the panel.

Using the Microload

- Insert a contact protection circuit, if necessary, to prevent the reduction of life expectancy due to extreme wear on the contacts caused by loads where inrush current occurs when the contact is opened and closed.
- The A16 allows both a standard load (125 V at 5A, 250 V at 3 A) and a microload. If a standard load is applied, however, the microload area cannot be used. If the microload area is used with a standard load, the contact surface will become rough, and the opening and closing of the contact for a microload may become unreliable.
- The minimum applicable load is the N-level reference value. This value indicates the malfunction reference level for the reliability level of 60% ($\lambda 60$) (conforming to JIS C5003).
The equation, $\lambda 60 = 0.5 \times 10^{-6}/\text{operations}$ indicates that the estimated malfunction rate is less than 1/2,000,000 operations with a reliability level of 60%.

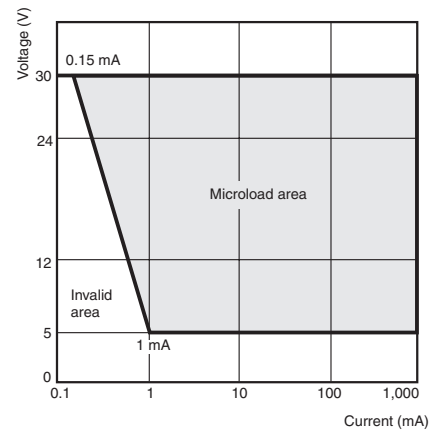

LED

- The LED current-limiting resistor is built-in, so external resistance is not required.

Rated voltage	Internal limiting resistor
5 VDC	Red, yellow: 300 Ω Green: 160 Ω
12 VAC/VDC	Red, yellow: 1 kΩ Green: 910 Ω
24 VAC/VDC	2.4 kΩ

Others

- The oil-resistant IP65 uses NBR rubber and is resistant to general cutting oil and cooling oil. Some particular oils cannot be used with the oil-resistant IP65, however, so contact your OMRON representative for details.
- If the panel is to be finished with coating, etc., make sure that the panel meets the specified dimensions after the coating.
- Do not subject the Switch to extreme shock or vibration. Doing so will cause malfunctions and damage to the Switch. Do not let sharp objects come into contact with the Switches that are made of resin. Doing so will damage the Switches, causing scratches on the outside of the operating parts, and malfunction. When handling the Switches, do not throw or drop them.



Read and Understand This Catalog

Please read and understand this catalog before purchasing the products. Please consult your OMRON representative if you have any questions or comments.

Warranty and Limitations of Liability

WARRANTY

OMRON's exclusive warranty is that the products are free from defects in materials and workmanship for a period of one year (or other period if specified) from date of sale by OMRON.

OMRON MAKES NO WARRANTY OR REPRESENTATION, EXPRESS OR IMPLIED, REGARDING NON-INFRINGEMENT, MERCHANTABILITY, OR FITNESS FOR PARTICULAR PURPOSE OF THE PRODUCTS. ANY BUYER OR USER ACKNOWLEDGES THAT THE BUYER OR USER ALONE HAS DETERMINED THAT THE PRODUCTS WILL SUITABLY MEET THE REQUIREMENTS OF THEIR INTENDED USE. OMRON DISCLAIMS ALL OTHER WARRANTIES, EXPRESS OR IMPLIED.

LIMITATIONS OF LIABILITY

OMRON SHALL NOT BE RESPONSIBLE FOR SPECIAL, INDIRECT, OR CONSEQUENTIAL DAMAGES, LOSS OF PROFITS OR COMMERCIAL LOSS IN ANY WAY CONNECTED WITH THE PRODUCTS, WHETHER SUCH CLAIM IS BASED ON CONTRACT, WARRANTY, NEGLIGENCE, OR STRICT LIABILITY.

In no event shall the responsibility of OMRON for any act exceed the individual price of the product on which liability is asserted.

IN NO EVENT SHALL OMRON BE RESPONSIBLE FOR WARRANTY, REPAIR, OR OTHER CLAIMS REGARDING THE PRODUCTS UNLESS OMRON'S ANALYSIS CONFIRMS THAT THE PRODUCTS WERE PROPERLY HANDLED, STORED, INSTALLED, AND MAINTAINED AND NOT SUBJECT TO CONTAMINATION, ABUSE, MISUSE, OR INAPPROPRIATE MODIFICATION OR REPAIR.

Application Considerations

SUITABILITY FOR USE

OMRON shall not be responsible for conformity with any standards, codes, or regulations that apply to the combination of products in the customer's application or use of the products.

At the customer's request, OMRON will provide applicable third party certification documents identifying ratings and limitations of use that apply to the products. This information by itself is not sufficient for a complete determination of the suitability of the products in combination with the end product, machine, system, or other application or use.

The following are some examples of applications for which particular attention must be given. This is not intended to be an exhaustive list of all possible uses of the products, nor is it intended to imply that the uses listed may be suitable for the products:

- Outdoor use, uses involving potential chemical contamination or electrical interference, or conditions or uses not described in this catalog.
- Nuclear energy control systems, combustion systems, railroad systems, aviation systems, medical equipment, amusement machines, vehicles, safety equipment, and installations subject to separate industry or government regulations.
- Systems, machines, and equipment that could present a risk to life or property.

Please know and observe all prohibitions of use applicable to the products.

NEVER USE THE PRODUCTS FOR AN APPLICATION INVOLVING SERIOUS RISK TO LIFE OR PROPERTY WITHOUT ENSURING THAT THE SYSTEM AS A WHOLE HAS BEEN DESIGNED TO ADDRESS THE RISKS, AND THAT THE OMRON PRODUCTS ARE PROPERLY RATED AND INSTALLED FOR THE INTENDED USE WITHIN THE OVERALL EQUIPMENT OR SYSTEM.

PROGRAMMABLE PRODUCTS

OMRON shall not be responsible for the user's programming of a programmable product, or any consequence thereof.

Disclaimers

CHANGE IN SPECIFICATIONS

Product specifications and accessories may be changed at any time based on improvements and other reasons.

It is our practice to change model numbers when published ratings or features are changed, or when significant construction changes are made. However, some specifications of the products may be changed without any notice. When in doubt, special model numbers may be assigned to fix or establish key specifications for your application on your request. Please consult with your OMRON representative at any time to confirm actual specifications of purchased products.

DIMENSIONS AND WEIGHTS

Dimensions and weights are nominal and are not to be used for manufacturing purposes, even when tolerances are shown.

PERFORMANCE DATA

Performance data given in this catalog is provided as a guide for the user in determining suitability and does not constitute a warranty. It may represent the result of OMRON's test conditions, and the users must correlate it to actual application requirements. Actual performance is subject to the OMRON Warranty and Limitations of Liability.

ERRORS AND OMISSIONS

The information in this document has been carefully checked and is believed to be accurate; however, no responsibility is assumed for clerical, typographical, or proofreading errors, or omissions.

2012.9

In the interest of product improvement, specifications are subject to change without notice.

OMRON Corporation
Industrial Automation Company

<http://www.ia.omron.com/>

(c)Copyright OMRON Corporation 2012 All Right Reserved.

Компания «Океан Электроники» предлагает заключение долгосрочных отношений при поставках импортных электронных компонентов на взаимовыгодных условиях!

Наши преимущества:

- Поставка оригинальных импортных электронных компонентов напрямую с производств Америки, Европы и Азии, а так же с крупнейших складов мира;
- Широкая линейка поставок активных и пассивных импортных электронных компонентов (более 30 млн. наименований);
- Поставка сложных, дефицитных, либо снятых с производства позиций;
- Оперативные сроки поставки под заказ (от 5 рабочих дней);
- Экспресс доставка в любую точку России;
- Помощь Конструкторского Отдела и консультации квалифицированных инженеров;
- Техническая поддержка проекта, помощь в подборе аналогов, поставка прототипов;
- Поставка электронных компонентов под контролем ВП;
- Система менеджмента качества сертифицирована по Международному стандарту ISO 9001;
- При необходимости вся продукция военного и аэрокосмического назначения проходит испытания и сертификацию в лаборатории (по согласованию с заказчиком);
- Поставка специализированных компонентов военного и аэрокосмического уровня качества (Xilinx, Altera, Analog Devices, Intersil, Interpoint, Microsemi, Actel, Aeroflex, Peregrine, VPT, Syfer, Eurofarad, Texas Instruments, MS Kennedy, Miteq, Cobham, E2V, MA-COM, Hittite, Mini-Circuits, General Dynamics и др.);

Компания «Океан Электроники» является официальным дистрибьютором и эксклюзивным представителем в России одного из крупнейших производителей разъемов военного и аэрокосмического назначения «JONHON», а так же официальным дистрибьютором и эксклюзивным представителем в России производителя высокотехнологичных и надежных решений для передачи СВЧ сигналов «FORSTAR».



JONHON

«JONHON» (основан в 1970 г.)

Разъемы специального, военного и аэрокосмического назначения:

(Применяются в военной, авиационной, аэрокосмической, морской, железнодорожной, горно- и нефтедобывающей отраслях промышленности)

«FORSTAR» (основан в 1998 г.)

ВЧ соединители, коаксиальные кабели,
кабельные сборки и микроволновые компоненты:

(Применяются в телекоммуникациях гражданского и специального назначения, в средствах связи, РЛС, а так же военной, авиационной и аэрокосмической отраслях промышленности).



Телефон: 8 (812) 309-75-97 (многоканальный)

Факс: 8 (812) 320-03-32

Электронная почта: ocean@oceanchips.ru

Web: <http://oceanchips.ru/>

Адрес: 198099, г. Санкт-Петербург, ул. Калинина, д. 2, корп. 4, лит. А