

PLEASE CHECK WWW.MOLEX.COM FOR LATEST PART INFORMATION

Part Number: [0785260001](#)
Status: **Active**
Description: 1.27mm (.050") Pitch SIM Card Holder with separate Detect Pin, 8 Circuits, Push-Push Style, Housing Height 1.50mm (.059"), with Pegs, Lead Free, Halogen Free

Documents:

[Drawing \(PDF\)](#) [RoHS Certificate of Compliance \(PDF\)](#)
[Product Specification PS-78526-001 \(PDF\)](#)

General

Product Family	Memory Card Sockets
Series	78526
Button Type	Push-Push
Comments	With Pegs
Component Type	Card Holder (Host)
Product Name	SIM
Type	N/A

Physical

Card Detection Switch	Yes
Circuits (Loaded)	8
Circuits (maximum)	8
Durability (mating cycles max)	10,000
Ejector Button Side	No Ejector Button Present
Entry Angle	Horizontal
Keying to Mating Part	Yes
Material - Metal	Copper Alloy
Material - Plating Mating	Gold
Material - Plating Termination	Tin
Material - Resin	High Temperature Thermoplastic
PCB Locator	Yes
PCB Mounting Side	Normal
PCB Retention	Yes
Packaging Type	Embossed Tape on Reel
Pitch - Mating Interface (in)	0.050 In
Pitch - Mating Interface (mm)	1.27 mm
Pitch - Term. Interface (in)	0.050 In
Pitch - Term. Interface (mm)	1.27 mm
Plating min: Mating (µin)	30
Plating min: Mating (µm)	0.76
Plating min: Termination (µin)	100
Plating min: Termination (µm)	2.54
Ports	1
Temperature Range - Operating	-20°C to +85°C
Termination Interface: Style	Surface Mount

Electrical

Current - Maximum per Contact	0.5A
Shielded	Yes
Voltage - Maximum	50V DC

Material Info

Reference - Drawing Numbers

Packaging Specification	PK-78526-001
Product Specification	PS-78526-001
Sales Drawing	SD-78526-001

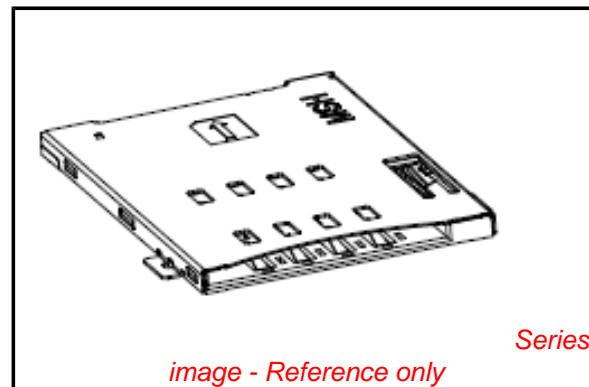

EU RoHS

**ELV and RoHS
Compliant**
**REACH SVHC
Not Reviewed**
**Halogen-Free
Status**

China RoHS



**Need more information on product
environmental compliance?**

Email productcompliance@molex.com
 For a multiple part number RoHS Certificate of Compliance, [click here](#)

Please visit the [Contact Us](#) section for any non-product compliance questions.

Search Parts in this Series

[78526Series](#)

Mates With

Standard SIM Card

This document was generated on 05/17/2010

PLEASE CHECK WWW.MOLEX.COM FOR LATEST PART INFORMATION

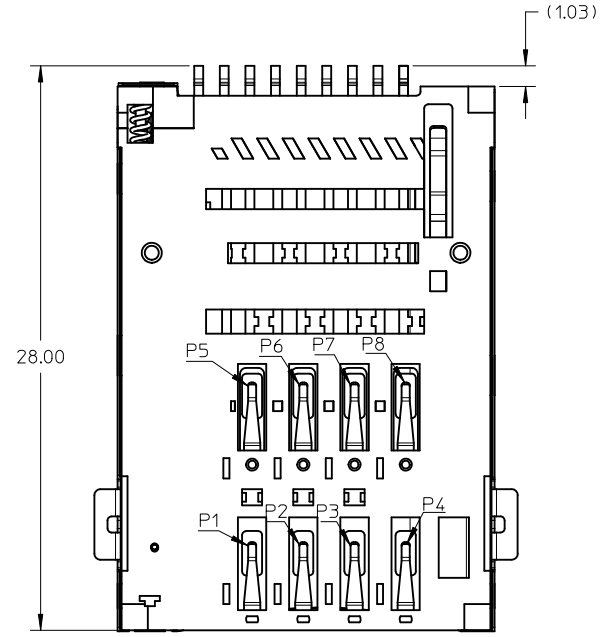
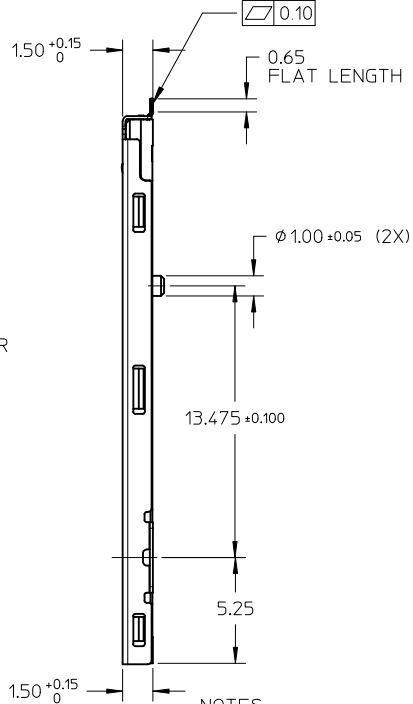
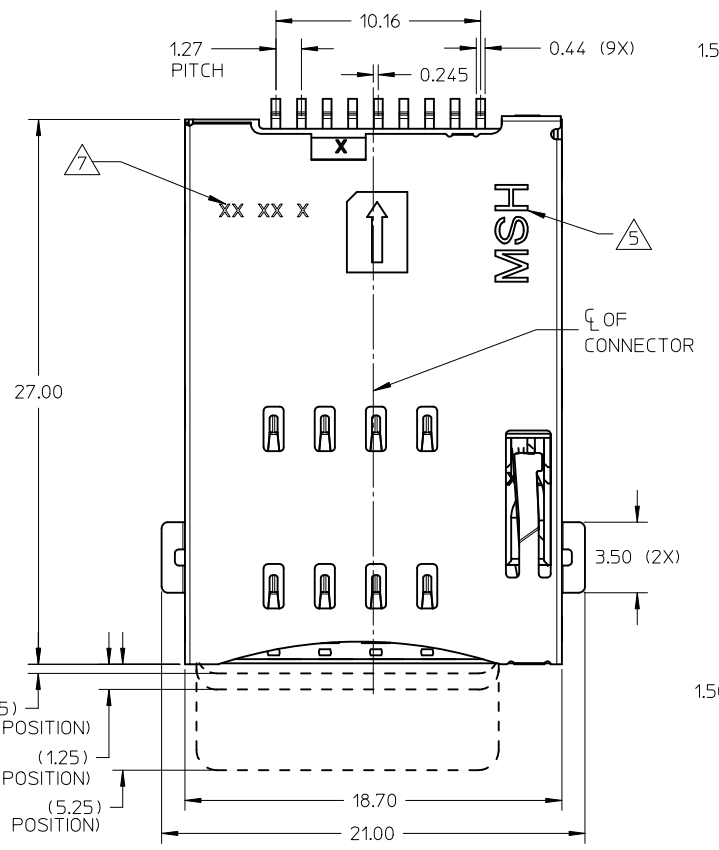

- NOTES:
1. MATERIALS: HOUSING, CAM, DUMMY CARD: HIGH TEMP THERMOPLASTIC, UL94V-0, BLACK
TERMINAL, DETECT PIN: COPPER ALLOY
METAL SHELL, COIL SPRING, CAM PIN: STAINLESS STEEL
 2. FINISHES: 0.76µm MIN GOLD ON CONTACT AREA OVER 1.27µm NICKEL UNDERPLATE.
2.54µm MIN MATTE TIN ON SOLDER TAIL AREA OVER 1.27µm NICKEL UNDERPLATE.
GOLD FLASH ON SHELL SOLDER TAB OVER 1.27µm NICKEL UNDERPLATE.
 3. PRODUCT SPECIFICATION: PS-78526-001
 4. PACKAGING SPECIFICATION: PK-78526-001
 5. MOLEX LOGO LOCATED APPROXIMATELY AS SHOWN.
 6. CONNECTOR OVERALL HEIGHT TO BE AT 1.75MM MAX DURING PUSH-PUSH FUNCTION.
 7. DATE CODE PRINTING: XX XX X

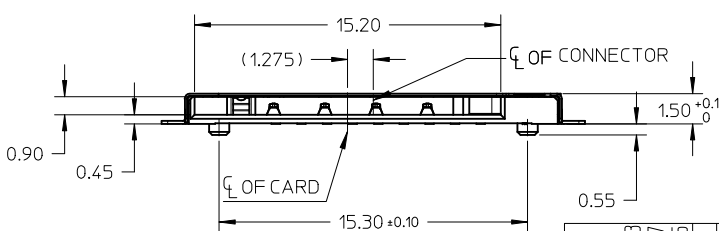

HALOGEN FREE

ADD NOTE 6 EC NO: S2010-0707 DRWN:CGOH CHKD:JTAN02 APPR:BOKOK 2010/02/23 2009/08/17 2010/03/05	QUALITY SYMBOLS F _A =0 F _E =0 F _P =0	GENERAL TOLERANCES (UNLESS SPECIFIED)		DIMENSION STYLE MM ONLY		SCALE NTS	DESIGN UNITS METRIC	THIRD ANGLE PROJECTION		
		mm	INCH	DRAWN BY	DATE	TITLE				
		4 PLACES ± ---	± ---	CGOH	2009/07/17	SIM CARD CONNECTOR				
		3 PLACES ± ---	± ---	CHECKED BY	DATE	PUSH PUSH TYPE				
2 PLACES ± 0.25	± ---	JTAN02	2009/08/17	HEIGHT 1.5MM						
1 PLACE ± ---	± ---	APPROVED BY	DATE	MOLEX INCORPORATED						
ANGULAR ± 3 °		BOKOK	2010/03/05	MATERIAL NO.		DOCUMENT NO.		SHEET NO.		
DRAFT WHERE APPLICABLE MUST REMAIN WITHIN DIMENSIONS		78526-0001		78526-0001		SD-78526-001		1 OF 3		
SIZE A4		THIS DRAWING CONTAINS INFORMATION THAT IS PROPRIETARY TO MOLEX INCORPORATED AND SHOULD NOT BE USED WITHOUT WRITTEN PERMISSION								

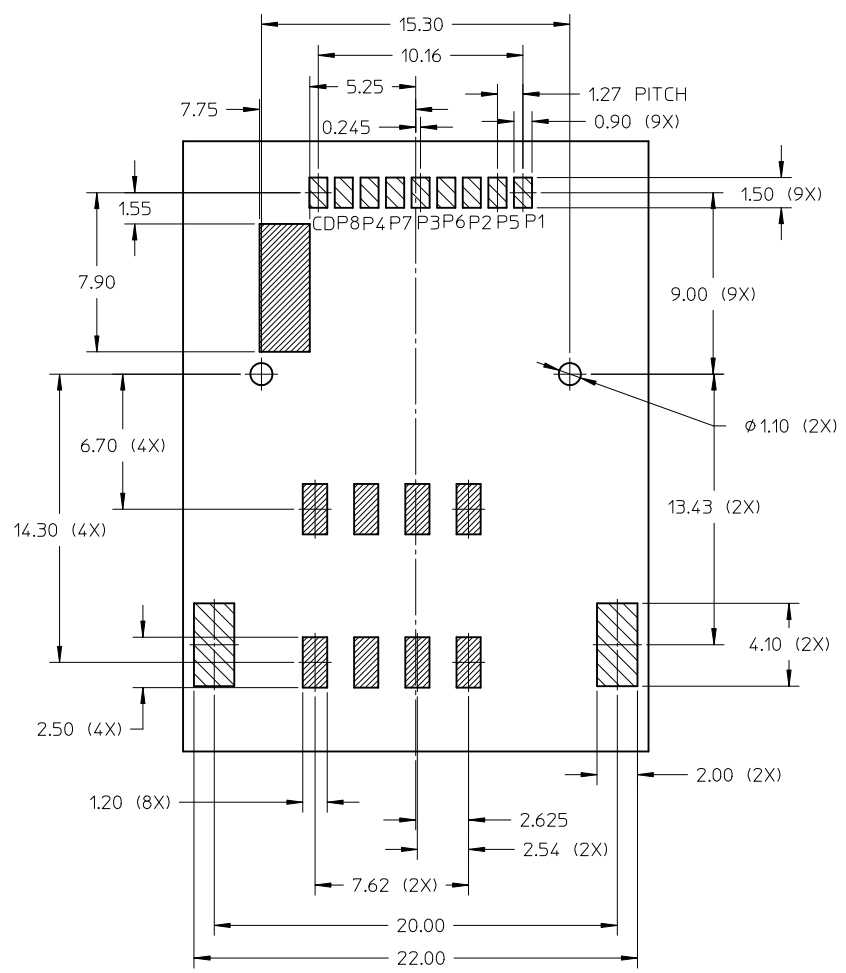

RECOMMENDED PCB LAYOUT
(GENERAL TOLERANCE+0.05)

- CIRCUIT TRACE KEEP OUT AREA
- SOLDERING PAD AREA

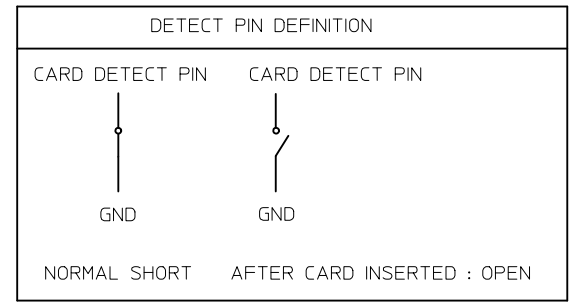
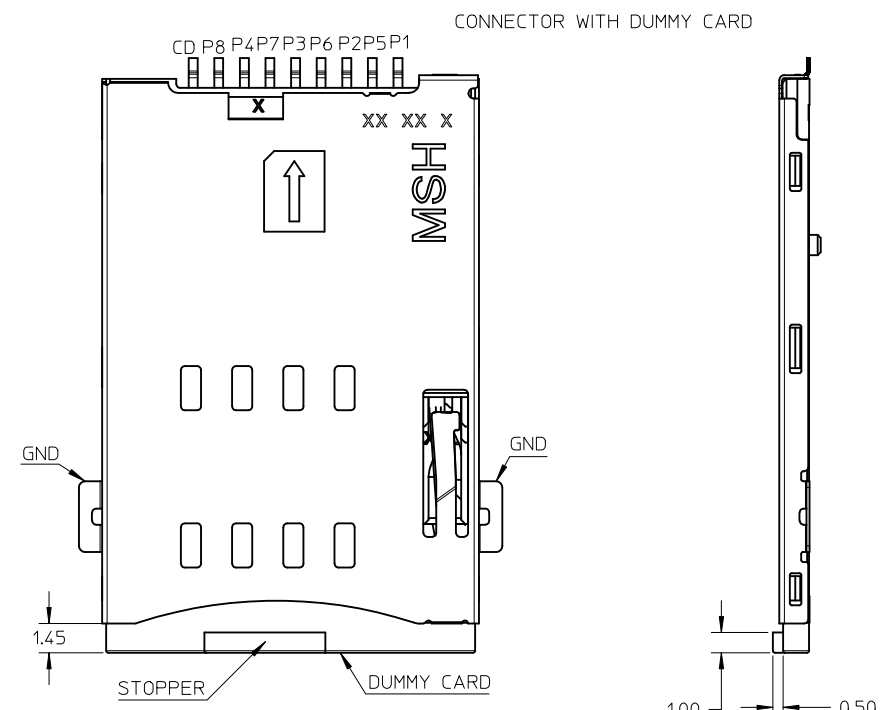

ADD NOTE 6 EC NO: S2010-0707 DRWN:CGOH CHKD:JTAN02 APPR:BOKOK 2010/02/23 2009/08/17 2010/03/05	QUALITY SYMBOLS	GENERAL TOLERANCES (UNLESS SPECIFIED)	DIMENSION STYLE	SCALE	DESIGN UNITS	THIRD ANGLE PROJECTION
	$F_A=0$ $F_C=0$ $F_P=0$	mm INCH 4 PLACES ± --- ± --- 3 PLACES ± --- ± --- 2 PLACES ± 0.25 ± --- 1 PLACE ± --- ± --- ANGULAR ± 3 °	MM ONLY	NTS	METRIC	
		DRAFT WHERE APPLICABLE MUST REMAIN WITHIN DIMENSIONS	DRAWN BY: CGOH DATE: 2009/07/17 CHECKED BY: JTAN02 DATE: 2009/08/17 APPROVED BY: BOKOK DATE: 2010/03/05	TITLE	SIM CARD CONNECTOR PUSH PUSH TYPE HEIGHT 1.5MM	
	A4		MATERIAL NO. 78526-0001 SIZE A3	MOLEX INCORPORATED DOCUMENT NO. SD-78526-001	SHEET NO. 2 OF 3	

TAPE AND REEL PACKING

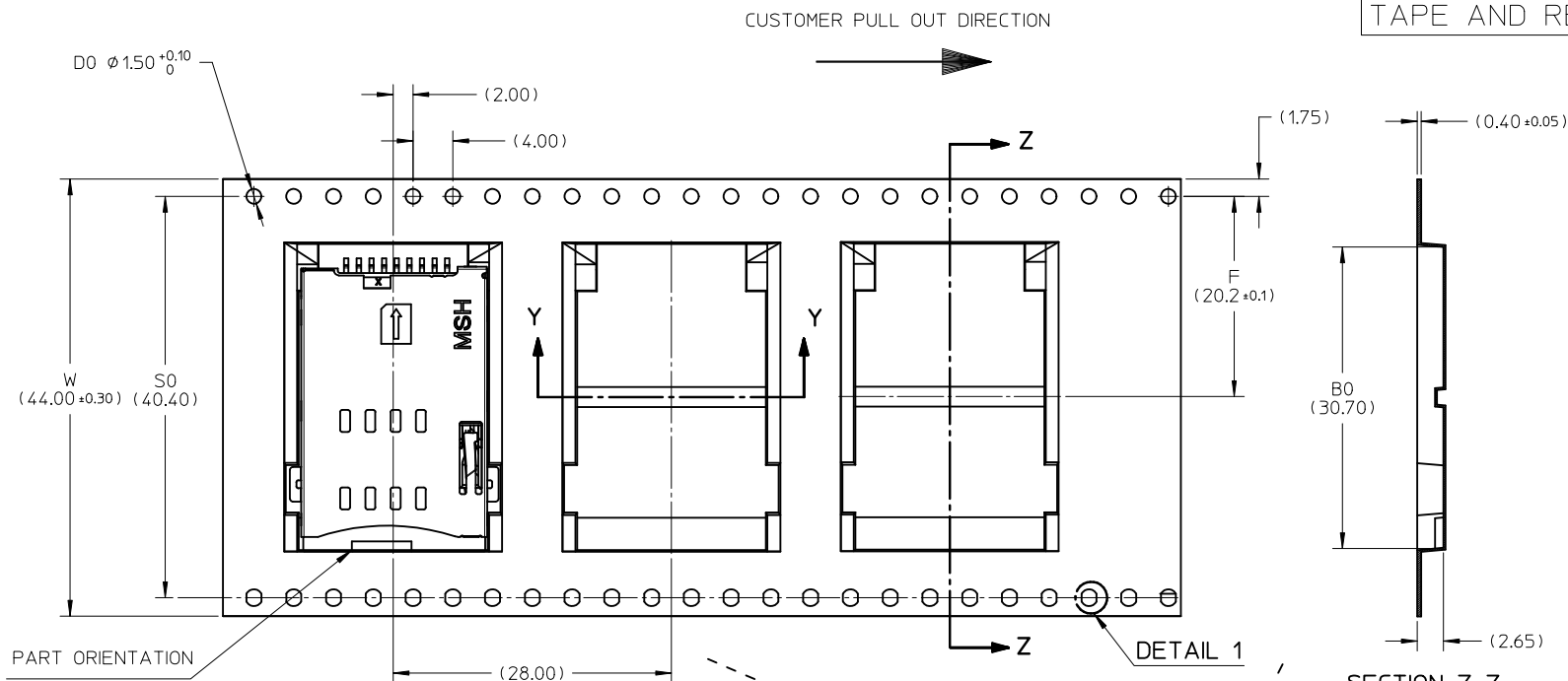

NOTES:

1. LEADER AND TRAILER TAPE

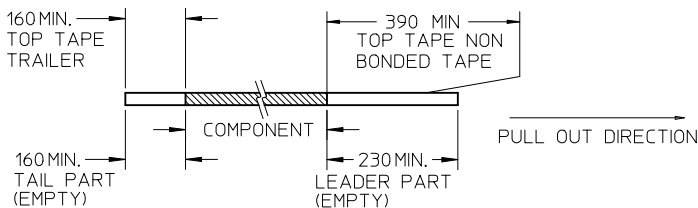

2. PEELING OFF FORCE OF THE TOP TAPE: 10 - 130gf. (PEELING DIRECTION AS SHOWN IN FOLLOWING FIGURE)



- 3. TAPE AND REEL SPECIFICATION IS AS PER EIA-481.
- 4. TAPE AND REEL QUANTITY : 600 PCS/ REEL.
- 5. THE TAPE IS TREATED FOR ANTI-STATIC.

ADD NOTE 6 EC NO: S2010-0707 DRWN:CGOH CHKD:JTAN02 APPR:BOKOK	2010/02/23 2009/08/17 2010/03/05	DESCRIPTION QUALITY SYMBOLS $F_A=0$ $F_C=0$ $F_P=0$	GENERAL TOLERANCES (UNLESS SPECIFIED)		DIMENSION STYLE MM ONLY		SCALE NTS	DESIGN UNITS METRIC	THIRD ANGLE PROJECTION		
				mm	INCH	DRAWN BY CGOH	DATE 2009/07/17	TITLE SIM CARD CONNECTOR PUSH PUSH TYPE HEIGHT 1.5MM			
			4 PLACES	± ---	± ---	CHECKED BY JTAN02	DATE 2009/08/17				
			3 PLACES	± ---	± ---	APPROVED BY BOKOK	DATE 2010/03/05	DOCUMENT NO. SD-78526-001			
2 PLACES	± 0.25	± ---	ANGULAR ± 3 °		MATERIAL NO. 78526-0001		SHEET NO. 3 OF 3				
1 PLACE	± ---	± ---	DRAFT WHERE APPLICABLE MUST REMAIN WITHIN DIMENSIONS		THIS DRAWING CONTAINS INFORMATION THAT IS PROPRIETARY TO MOLEX INCORPORATED AND SHOULD NOT BE USED WITHOUT WRITTEN PERMISSION						

Компания «Океан Электроники» предлагает заключение долгосрочных отношений при поставках импортных электронных компонентов на взаимовыгодных условиях!

Наши преимущества:

- Поставка оригинальных импортных электронных компонентов напрямую с производств Америки, Европы и Азии, а так же с крупнейших складов мира;
- Широкая линейка поставок активных и пассивных импортных электронных компонентов (более 30 млн. наименований);
- Поставка сложных, дефицитных, либо снятых с производства позиций;
- Оперативные сроки поставки под заказ (от 5 рабочих дней);
- Экспресс доставка в любую точку России;
- Помощь Конструкторского Отдела и консультации квалифицированных инженеров;
- Техническая поддержка проекта, помощь в подборе аналогов, поставка прототипов;
- Поставка электронных компонентов под контролем ВП;
- Система менеджмента качества сертифицирована по Международному стандарту ISO 9001;
- При необходимости вся продукция военного и аэрокосмического назначения проходит испытания и сертификацию в лаборатории (по согласованию с заказчиком);
- Поставка специализированных компонентов военного и аэрокосмического уровня качества (Xilinx, Altera, Analog Devices, Intersil, Interpoint, Microsemi, Actel, Aeroflex, Peregrine, VPT, Syfer, Eurofarad, Texas Instruments, MS Kennedy, Miteq, Cobham, E2V, MA-COM, Hittite, Mini-Circuits, General Dynamics и др.);

Компания «Океан Электроники» является официальным дистрибьютором и эксклюзивным представителем в России одного из крупнейших производителей разъемов военного и аэрокосмического назначения «JONHON», а так же официальным дистрибьютором и эксклюзивным представителем в России производителя высокотехнологичных и надежных решений для передачи СВЧ сигналов «FORSTAR».



JONHON

«JONHON» (основан в 1970 г.)

Разъемы специального, военного и аэрокосмического назначения:

(Применяются в военной, авиационной, аэрокосмической, морской, железнодорожной, горно- и нефтедобывающей отраслях промышленности)

«FORSTAR» (основан в 1998 г.)

ВЧ соединители, коаксиальные кабели, кабельные сборки и микроволновые компоненты:

(Применяются в телекоммуникациях гражданского и специального назначения, в средствах связи, РЛС, а так же военной, авиационной и аэрокосмической отраслях промышленности).



Телефон: 8 (812) 309-75-97 (многоканальный)

Факс: 8 (812) 320-03-32

Электронная почта: ocean@oceanchips.ru

Web: <http://oceanchips.ru/>

Адрес: 198099, г. Санкт-Петербург, ул. Калинина, д. 2, корп. 4, лит. А