



Low Distortion Differential RF/IF Amplifier

Enhanced Product

AD8351-EP

FEATURES

- 3 dB bandwidth of 2.2 GHz for $A_v = 12$ dB
- Single-resistor programmable gain: $0 \text{ dB} \leq A_v \leq 26 \text{ dB}$
- Differential interface
- Low noise input stage: $2.70 \text{ nV}/\sqrt{\text{Hz}}$ at 70 MHz, $A_v = 10$ dB
- Low harmonic distortion
 - 79 dBc second at 70 MHz
 - 81 dBc third at 70 MHz
- Output third-order intercept (OIP3) of 31 dBm at 70 MHz
- Single-supply operation: 3 V to 5.5 V
- Low power dissipation: 28 mA at 5 V
- Adjustable output common-mode voltage
- Fast settling and overdrive recovery
- Slew rate of $13,000 \text{ V}/\mu\text{s}$
- Power-down capability

ENHANCED PRODUCT FEATURES

- Supports defense and aerospace applications (AQEC standard)
- Extended industrial temperature range: -55°C to $+105^\circ\text{C}$
- Controlled manufacturing baseline
- 1 assembly/test site
- 1 fabrication site
- Product change notification
- Qualification data available upon request

APPLICATIONS

- Differential ADC drivers
- Single-ended-to-differential conversion
- IF sampling receivers
- RF/IF gain blocks
- Surface acoustic wave (SAW) filter interfacing

GENERAL DESCRIPTION

The **AD8351-EP** is a low cost differential amplifier useful in RF and IF applications up to 2.2 GHz. The voltage gain can be set from unity to 26 dB using a single external gain resistor. The **AD8351-EP** provides a nominal 150Ω differential output impedance. The excellent distortion performance and low noise characteristics of this device allow a wide range of applications.

The **AD8351-EP** is designed to satisfy the demanding performance requirements of communications transceiver applications. The device can be used as a general-purpose gain block, an ADC driver, and a high speed data interface driver, among other functions. The **AD8351-EP** can also be used as a single-ended-to-differential amplifier with similar distortion

FUNCTIONAL BLOCK DIAGRAM

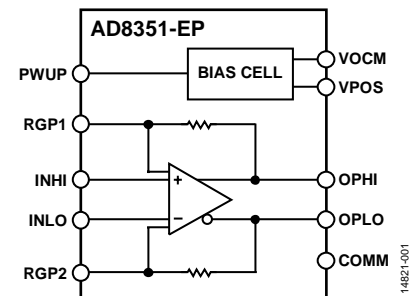

Figure 1.

products as in the differential configuration. The exceptionally good distortion performance makes the **AD8351-EP** an ideal solution for 12-bit and 14-bit IF sampling receiver designs.

Fabricated in the Analog Devices, Inc., high speed XFCB process, the **AD8351-EP** has a high bandwidth that provides high frequency performance and low distortion. The quiescent current of the **AD8351-EP** is 28 mA typically. The **AD8351-EP** amplifier comes in a 16-lead LFCSP package, and operates over the temperature range of -55°C to $+105^\circ\text{C}$.

Additional application and technical information can be found in the **AD8351** datasheet.

Rev. A

[Document Feedback](#)

Information furnished by Analog Devices is believed to be accurate and reliable. However, no responsibility is assumed by Analog Devices for its use, nor for any infringements of patents or other rights of third parties that may result from its use. Specifications subject to change without notice. No license is granted by implication or otherwise under any patent or patent rights of Analog Devices. Trademarks and registered trademarks are the property of their respective owners.

One Technology Way, P.O. Box 9106, Norwood, MA 02062-9106, U.S.A.
Tel: 781.329.4700 ©2016 Analog Devices, Inc. All rights reserved.
[Technical Support](#) www.analog.com

TABLE OF CONTENTS

Features	1	Absolute Maximum Ratings	5
Enhanced Product Features	1	Maximum Power Dissipation	5
Applications.....	1	ESD Caution.....	5
Functional Block Diagram	1	Pin Configuration and Function Descriptions.....	6
General Description	1	Typical Performance Characteristics	7
Revision History	2	Outline Dimensions	12
Specifications.....	3	Ordering Guide	12

REVISION HISTORY

9/2016—Rev. 0 to Rev. A

Change to Quiescent Current Parameter, Table 1.....	3
Changes to Ordering Guide	12

7/2016—Revision 0: Initial Version

SPECIFICATIONS

$V_S = 5\text{ V}$, $R_L = 150\ \Omega$, $R_G = 110\ \Omega$ ($A_V = 10\text{ dB}$), $f = 70\text{ MHz}$, $T = 25^\circ\text{C}$, parameters specified differentially, unless otherwise noted. The gain (A_V) can be set to any value between 0 dB and 26 dB.

Table 1.

Parameter	Test Conditions/Comments	Min	Typ	Max	Unit
DYNAMIC PERFORMANCE					
-3 dB Bandwidth	$A_V = 6\text{ dB}$, $V_{OUT} \leq 1.0\text{ V p-p}$		3000		MHz
	$A_V = 12\text{ dB}$, $V_{OUT} \leq 1.0\text{ V p-p}$		2200		MHz
	$A_V = 18\text{ dB}$, $V_{OUT} \leq 1.0\text{ V p-p}$		600		MHz
Bandwidth for 0.1 dB Flatness	$0\text{ dB} \leq A_V \leq 20\text{ dB}$, $V_{OUT} \leq 1.0\text{ V p-p}$		200		MHz
Bandwidth for 0.2 dB Flatness	$0\text{ dB} \leq A_V \leq 20\text{ dB}$, $V_{OUT} \leq 1.0\text{ V p-p}$		400		MHz
Gain Accuracy	Using 1% resistor for R_G , $0\text{ dB} \leq A_V \leq 20\text{ dB}$		± 1		dB
Gain Supply Sensitivity	$V_S \pm 5\%$		0.08		dB/V
Gain Temperature Sensitivity	-55°C to $+105^\circ\text{C}$		3.9		mdB/ $^\circ\text{C}$
Slew Rate	$R_L = 1\text{ k}\Omega$, $V_{OUT} = 2\text{ V step}$		13,000		V/ μs
	$R_L = 150\ \Omega$, $V_S = 2\text{ V step}$		7500		V/ μs
Settling Time	1 V step to 1%		<3		ns
Overdrive Recovery Time	$V_{IN} = 4\text{ V}$ to 0 V step, $V_{OUT} \leq \pm 10\text{ mV}$		<2		ns
Reverse Isolation (S12)			-67		dB
INPUT/OUTPUT CHARACTERISTICS					
Input Common-Mode Voltage Adjustment Range			1.2 to 3.8		V
Maximum Output Voltage Swing	1 dB compressed		4.75		V p-p
Output Common-Mode Offset			40		mV
Output Common-Mode Drift	-55°C to $+105^\circ\text{C}$		0.24		mV/ $^\circ\text{C}$
Output Differential Offset Voltage			20		mV
Output Differential Offset Drift	-55°C to $+105^\circ\text{C}$		0.13		mV/ $^\circ\text{C}$
Input Bias Current			± 15		μA
Input Resistance ¹			5		k Ω
Input Capacitance ¹			0.8		pF
Common-Mode Rejection Ratio (CMRR)			43		dB
Output Resistance ¹			150		Ω
Output Capacitance ¹			0.8		pF
POWER INTERFACE					
Supply Voltage		3		5.5	V
PWUP Threshold			1.3		V
PWUP Input Bias Current	PWUP at 5 V		100		μA
	PWUP at 0 V		25		μA
Quiescent Current	-55°C to $+105^\circ\text{C}$		28	35	mA
NOISE/DISTORTION					
10 MHz					
Second/Third Harmonic Distortion ²	$R_L = 1\text{ k}\Omega$, $V_{OUT} = 2\text{ V p-p}$		-95/-93		dBc
	$R_L = 150\ \Omega$, $V_{OUT} = 2\text{ V p-p}$		-80/-69		dBc
Third-Order Intermodulation Distortion (IMD)	$R_L = 1\text{ k}\Omega$, $f_1 = 9.5\text{ MHz}$, $f_2 = 10.5\text{ MHz}$, $V_{OUT} = 2\text{ V p-p}$ composite		-90		dBc
	$R_L = 150\ \Omega$, $f_1 = 9.5\text{ MHz}$, $f_2 = 10.5\text{ MHz}$, $V_{OUT} = 2\text{ V p-p}$ composite		-70		dBc
Output Third-Order Intercept	$f_1 = 9.5\text{ MHz}$, $f_2 = 10.5\text{ MHz}$		33		dBm
Noise Spectral Density (Referred to Input (RTI))			2.65		nV/ $\sqrt{\text{Hz}}$
1 dB Compression Point			13.5		dBm

Parameter	Test Conditions/Comments	Min	Typ	Max	Unit
70 MHz					
Second/Third Harmonic Distortion ²	$R_L = 1\text{ k}\Omega$, $V_{OUT} = 2\text{ V p-p}$		-79/-81		dBc
	$R_L = 150\ \Omega$, $V_{OUT} = 2\text{ V p-p}$		-65/-66		dBc
Third-Order IMD	$R_L = 1\text{ k}\Omega$, $f_1 = 69.5\text{ MHz}$, $f_2 = 70.5\text{ MHz}$, $V_{OUT} = 2\text{ V p-p composite}$		-85		dBc
	$R_L = 150\ \Omega$, $f_1 = 69.5\text{ MHz}$, $f_2 = 70.5\text{ MHz}$, $V_{OUT} = 2\text{ V p-p composite}$		-69		dBc
Output Third-Order Intercept	$f_1 = 69.5\text{ MHz}$, $f_2 = 70.5\text{ MHz}$		31		dBm
Noise Spectral Density (RTI)			2.70		nV/ $\sqrt{\text{Hz}}$
1 dB Compression Point			13.3		dBm
140 MHz					
Second/Third Harmonic Distortion ²	$R_L = 1\text{ k}\Omega$, $V_{OUT} = 2\text{ V p-p}$		-69/-69		dBc
	$R_L = 150\ \Omega$, $V_{OUT} = 2\text{ V p-p}$		-54/-53		dBc
Third-Order IMD	$R_L = 1\text{ k}\Omega$, $f_1 = 139.5\text{ MHz}$, $f_2 = 140.5\text{ MHz}$, $V_{OUT} = 2\text{ V p-p composite}$		-79		dBc
	$R_L = 150\ \Omega$, $f_1 = 139.5\text{ MHz}$, $f_2 = 140.5\text{ MHz}$, $V_{OUT} = 2\text{ V p-p composite}$		-67		dBc
Output Third-Order Intercept	$f_1 = 139.5\text{ MHz}$, $f_2 = 140.5\text{ MHz}$		29		dBm
Noise Spectral Density (RTI)			2.75		nV/ $\sqrt{\text{Hz}}$
1 dB Compression Point			13		dBm
240 MHz					
Second/Third Harmonic Distortion ²	$R_L = 1\text{ k}\Omega$, $V_{OUT} = 2\text{ V p-p}$		-60/-66		dBc
	$R_L = 150\ \Omega$, $V_{OUT} = 2\text{ V p-p}$		-46/-50		dBc
Third-Order IMD	$R_L = 1\text{ k}\Omega$, $f_1 = 239.5\text{ MHz}$, $f_2 = 240.5\text{ MHz}$, $V_{OUT} = 2\text{ V p-p composite}$		-76		dBc
	$R_L = 150\ \Omega$, $f_1 = 239.5\text{ MHz}$, $f_2 = 240.5\text{ MHz}$, $V_{OUT} = 2\text{ V p-p composite}$		-62		dBc
Output Third-Order Intercept	$f_1 = 239.5\text{ MHz}$, $f_2 = 240.5\text{ MHz}$		27		dBm
Noise Spectral Density (RTI)			2.90		nV/ $\sqrt{\text{Hz}}$
1 dB Compression Point			13		dBm

¹ Values are specified differentially.

² See the AD8351 data sheet for information about single-ended to differential operation.

ABSOLUTE MAXIMUM RATINGS

Table 2.

Parameter	Rating
Supply Voltage, VPOS	6 V
PWUP Voltage	VPOS
Internal Power Dissipation	320 mW
θ_{JA}	79.1°C/W
Maximum Junction Temperature	125°C
Operating Temperature Range	-55°C to +105°C
Storage Temperature Range	-65°C to +150°C
Lead Temperature Range (Soldering, 60 sec)	300°C

Stresses at or above those listed under Absolute Maximum Ratings may cause permanent damage to the product. This is a stress rating only; functional operation of the product at these or any other conditions above those indicated in the operational section of this specification is not implied. Operation beyond the maximum operating conditions for extended periods may affect product reliability.

MAXIMUM POWER DISSIPATION

The maximum power that can be safely dissipated by this device is limited by the associated rise in junction temperature. Exceeding a junction temperature of 125°C for an extended period can result in device failure.

To ensure proper operation of the [AD8351-EP](#), it is necessary to observe the maximum power derating curve (see Figure 2) to guarantee that the maximum junction temperature (125°C) is not exceeded under all conditions.

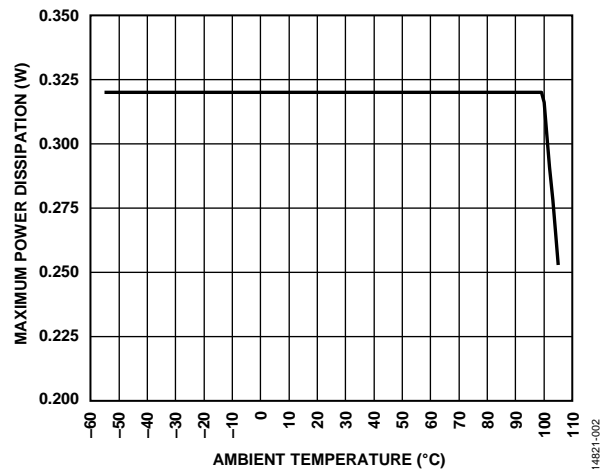

Figure 2. Maximum Power Dissipation vs. Temperature

ESD CAUTION



ESD (electrostatic discharge) sensitive device. Charged devices and circuit boards can discharge without detection. Although this product features patented or proprietary protection circuitry, damage may occur on devices subjected to high energy ESD. Therefore, proper ESD precautions should be taken to avoid performance degradation or loss of functionality.

PIN CONFIGURATION AND FUNCTION DESCRIPTIONS

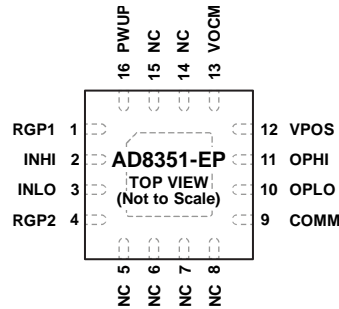

NOTES

1. NC = NO CONNECT. DO NOT CONNECT TO THIS PIN.
2. THE EXPOSED PAD IS INTERNALLY CONNECTED TO GND AND MUST BE SOLDERED TO A LOW IMPEDANCE GROUND PLANE.

14821-003

Figure 3. Pin Configuration

Table 3. Pin Function Descriptions

Pin No.	Mnemonic	Description
1	RGP1	Gain Resistor Input 1.
2	INHI	Balanced Differential Input, High. Biased to midsupply, typically ac-coupled.
3	INLO	Balanced Differential Input, Low. Biased to midsupply, typically ac-coupled.
4	RGP2	Gain Resistor Input 2.
5, 6, 7, 8, 14, 15	NC	No Connect. Do not connect to this pin.
9	COMM	Device Common. Connect this pin to a low impedance ground.
10	OPLO	Balanced Differential Output, Low. Biased to V _{OCM} , typically ac-coupled.
11	OPHI	Balanced Differential Output, High. Biased to V _{OCM} , typically ac-coupled.
12	VPOS	Positive Supply Voltage. 3 V to 5.5 V.
13	VOCM	Input/Output Common-Mode Voltage. The voltage applied to this pin sets the common-mode voltage at both the input and output. This pin is typically decoupled to ground with a 0.1 μ F capacitor.
16	PWUP	Apply a positive voltage ($1.3 \text{ V} \leq V_{PWUP} \leq V_{POS}$) to activate the device.
	EPAD	Exposed Pad. The exposed pad is internally connected to GND and must be soldered to a low impedance ground plane.

TYPICAL PERFORMANCE CHARACTERISTICS

$V_S = 5\text{ V}$, $T = 25^\circ\text{C}$, unless otherwise noted.

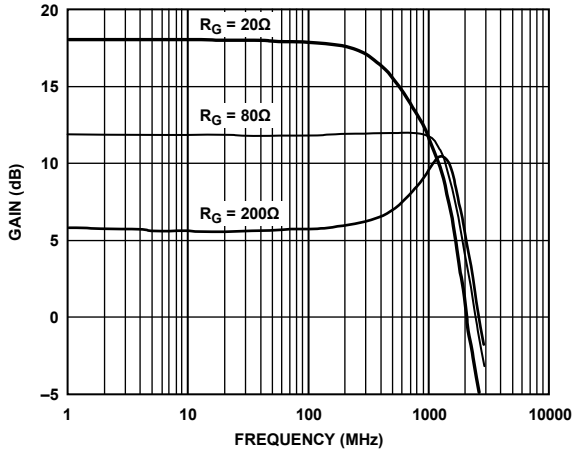

Figure 4. Gain vs. Frequency for a 150 Ω Differential Load ($A_V = 6\text{ dB}$, 12 dB , and 18 dB)

14821-103

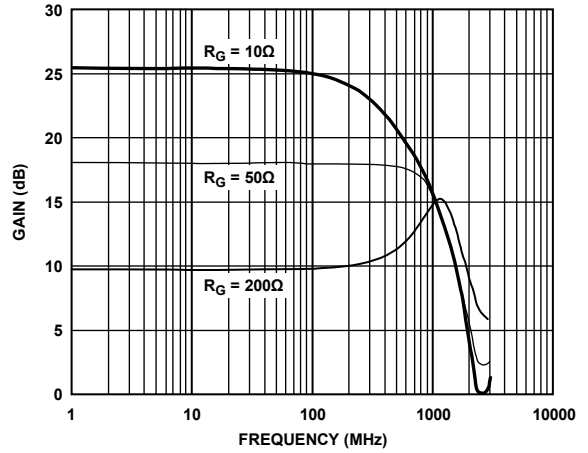

Figure 7. Gain vs. Frequency for a 1 kΩ Differential Load ($A_V = 10\text{ dB}$, 18 dB , and 26 dB)

14821-006

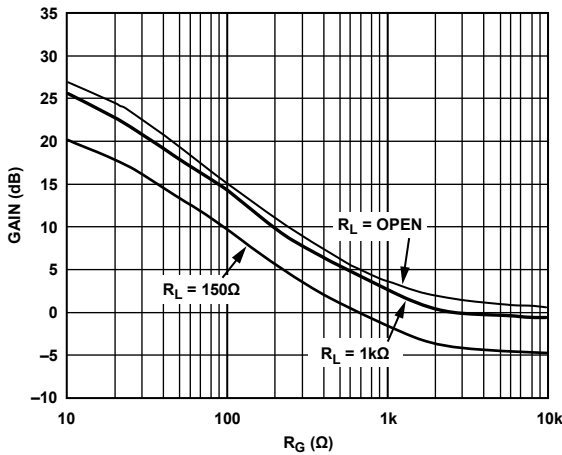

Figure 5. Gain vs. Gain Resistor, R_G ($f = 100\text{ MHz}$, $R_L = 150\ \Omega$, $1\text{ k}\Omega$, and Open)

14821-004

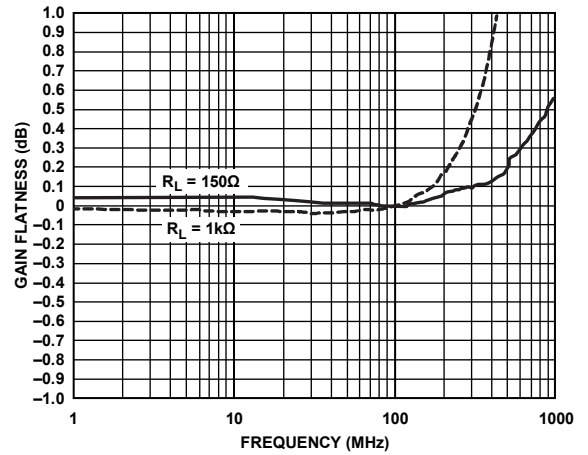

Figure 8. Gain Flatness vs. Frequency ($R_L = 150\ \Omega$ and $1\text{ k}\Omega$, $A_V = 10\text{ dB}$)

14821-007

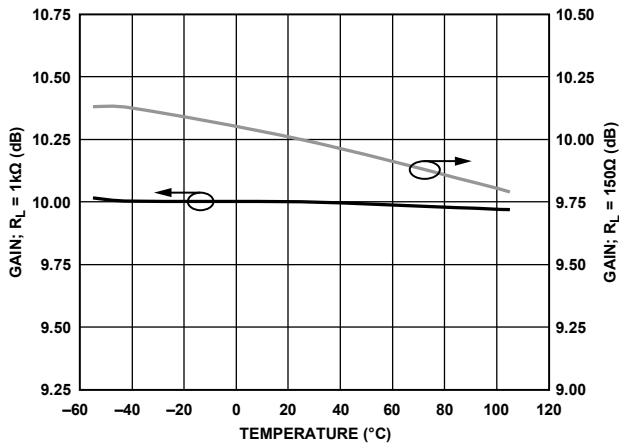

Figure 6. Gain vs. Temperature at 100 MHz ($A_V = 10\text{ dB}$)

14821-005

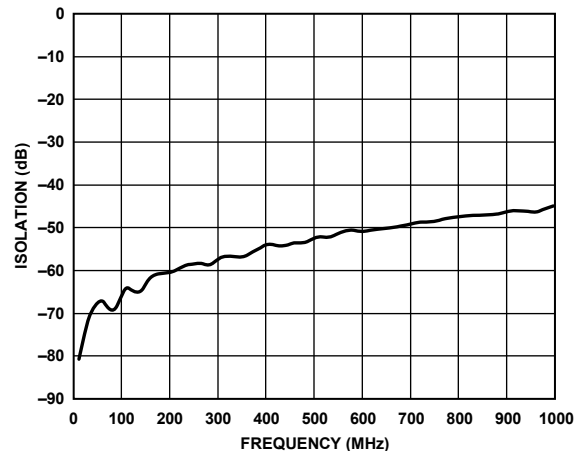

Figure 9. Isolation vs. Frequency ($A_V = 10\text{ dB}$)

14821-008

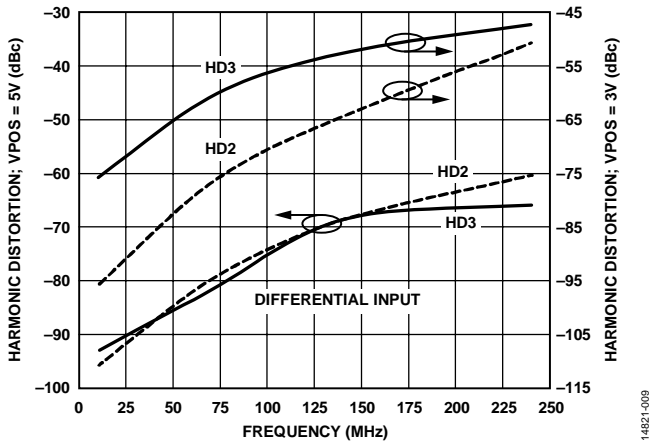

Figure 10. Harmonic Distortion vs. Frequency for 2 V p-p into $R_L = 1\text{ k}\Omega$ ($A_V = 10\text{ dB}$, at 3 V and 5 V Supplies)

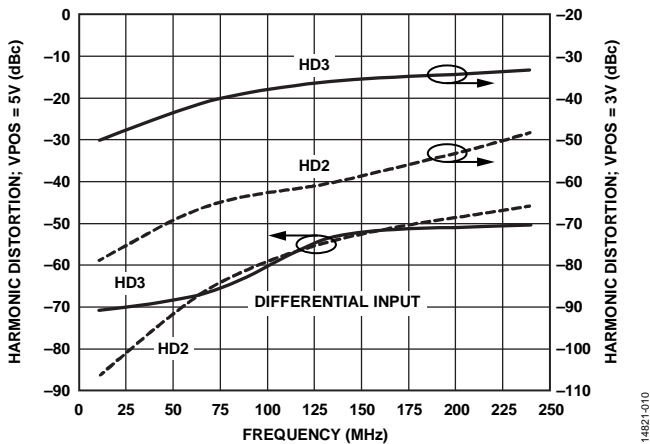

Figure 11. Harmonic Distortion vs. Frequency for 2 V p-p into $R_L = 150\ \Omega$ ($A_V = 10\text{ dB}$)

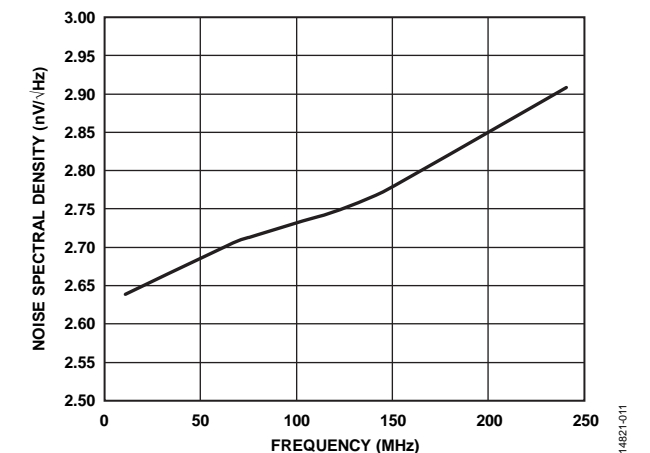

Figure 12. Noise Spectral Density (RTI) vs. Frequency ($R_L = 150\ \Omega$, 5 V Supply, $A_V = 10\text{ dB}$)

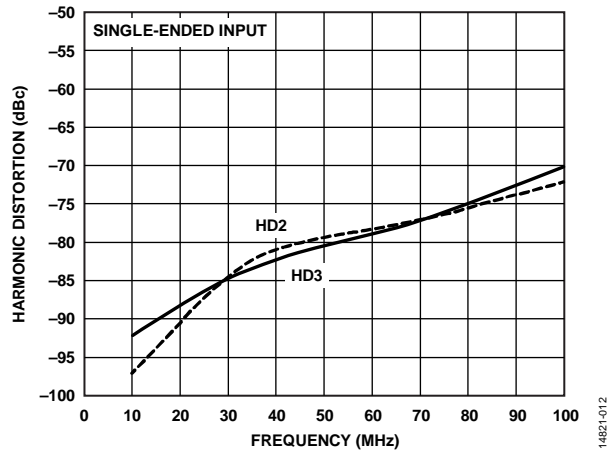

Figure 13. Harmonic Distortion vs. Frequency for 2 V p-p into $R_L = 1\text{ k}\Omega$ Using Single-Ended Input ($A_V = 10\text{ dB}$)

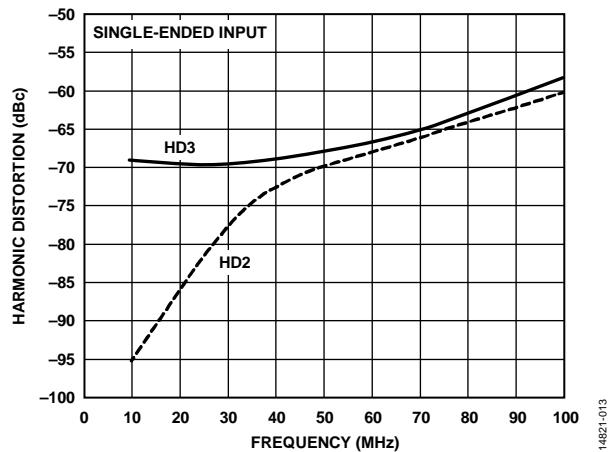

Figure 14. Harmonic Distortion vs. Frequency for 2 V p-p into $R_L = 150\ \Omega$ Using Single-Ended Input ($A_V = 10\text{ dB}$)

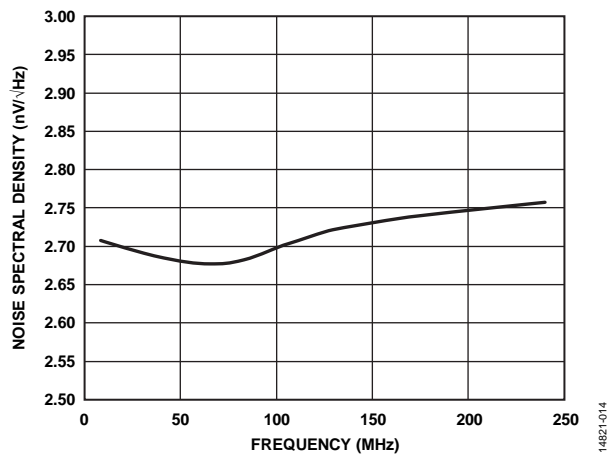

Figure 15. Noise Spectral Density (RTI) vs. Frequency ($R_L = 150\ \Omega$, 3 V Supply, $A_V = 10\text{ dB}$)

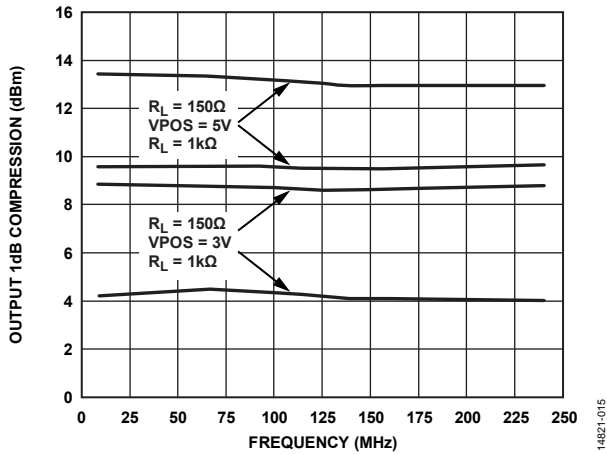

Figure 16. Output 1 dB Compression (P1dB) vs. Frequency ($R_L = 150\Omega$ and $1k\Omega$, $A_V = 10$ dB, at 3 V and 5 V Supplies)

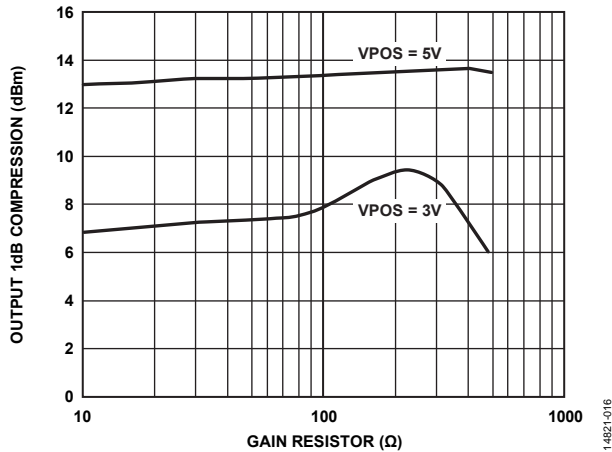

Figure 17. Output 1 dB Compression (P1dB) vs. Gain Resistor (R_G) ($f = 100$, $R_L = 150\Omega$, $A_V = 10$ dB, at 3 V and 5 V Supplies)

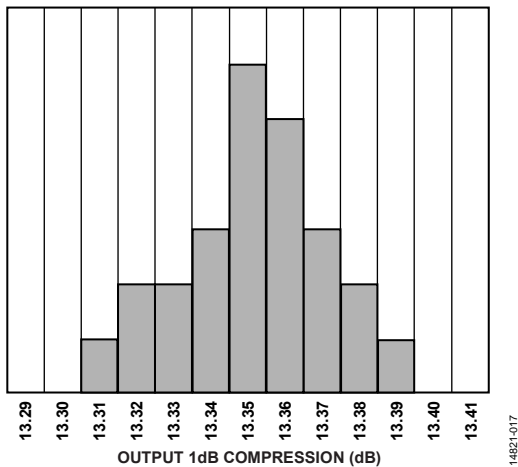

Figure 18. Output Compression Point Distribution ($f = 70$ MHz, $R_L = 150\Omega$, $A_V = 10$ dB)

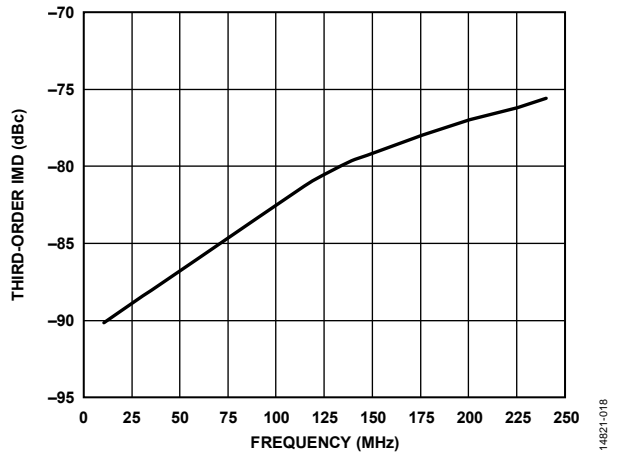

Figure 19. Third-Order Intermodulation Distortion (IMD) vs. Frequency for a 2 V p-p Composite Signal into $R_L = 1k\Omega$ ($A_V = 10$ dB, at 5 V Supplies)

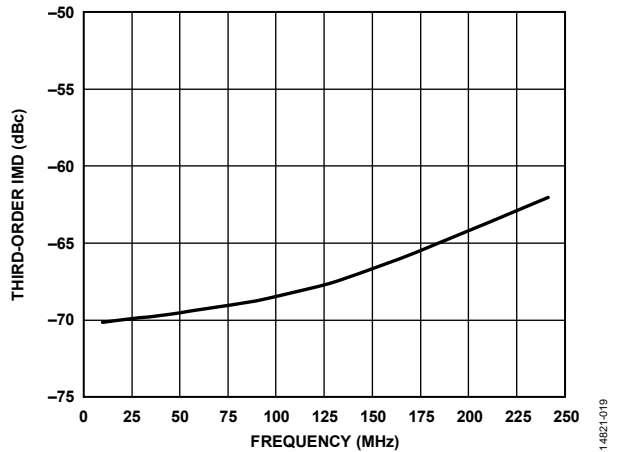

Figure 20. Third-Order Intermodulation Distortion vs. Frequency for a 2 V p-p Composite Signal into $R_L = 150\Omega$ ($A_V = 10$ dB, at 5 V Supplies)

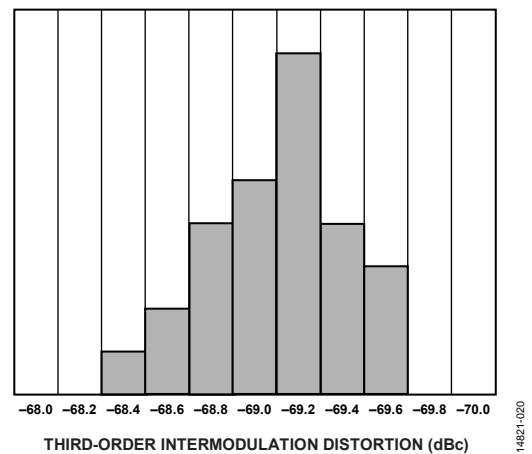

Figure 21. Third-Order Intermodulation Distortion Distribution ($f = 70$ MHz, $R_L = 150\Omega$, $A_V = 10$ dB)

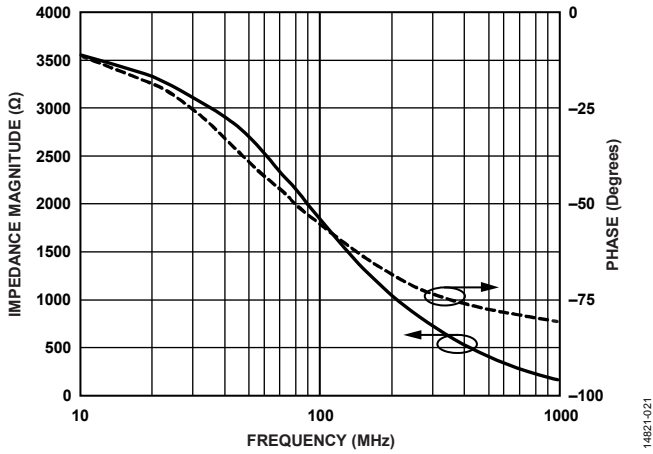

Figure 22. Input Impedance vs. Frequency

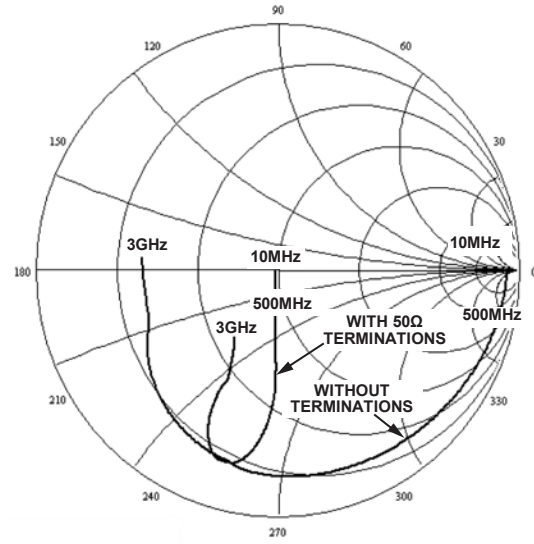

Figure 25. Input Reflection Coefficient vs. Frequency ($R_s = R_L = 100 \Omega$ With and Without 50Ω Terminations)

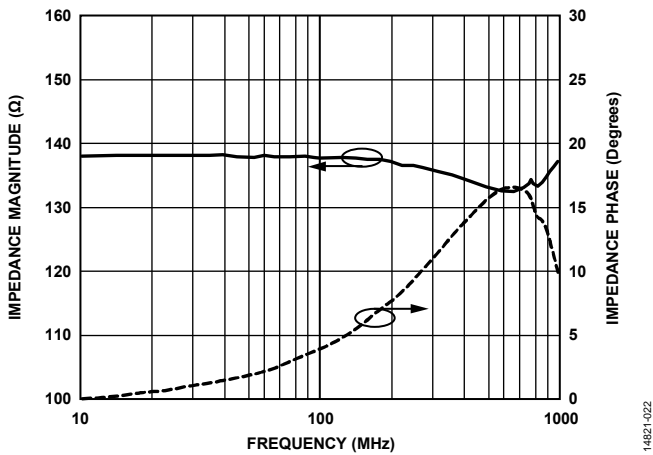

Figure 23. Output Impedance Magnitude and Phase vs. Frequency

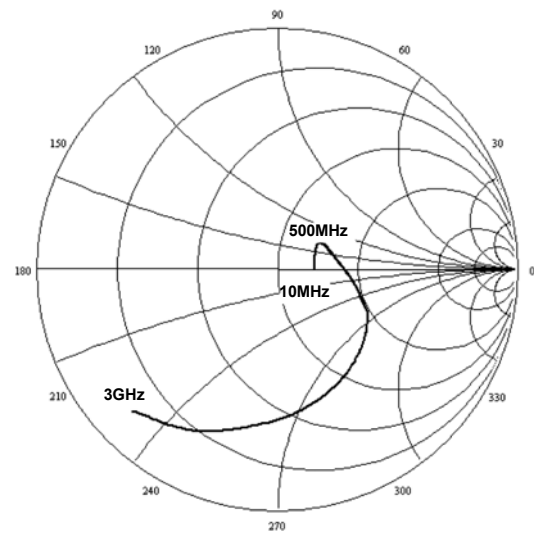

Figure 26. Output Reflection Coefficient vs. Frequency ($R_s = R_L = 100 \Omega$)

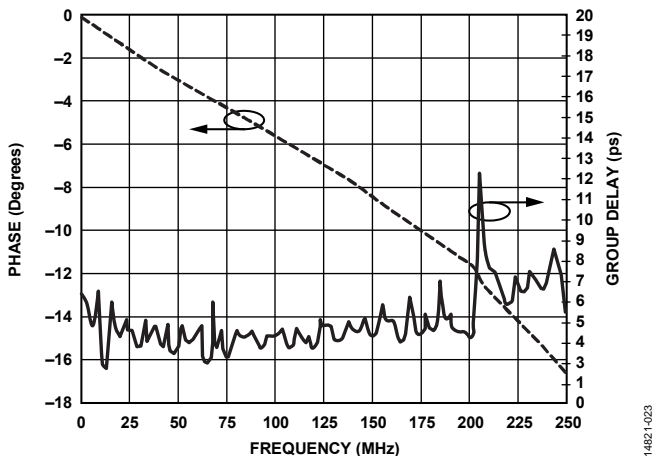

Figure 24. Phase and Group Delay ($A_v = 10 \text{ dB}$, at 5 V Supplies)

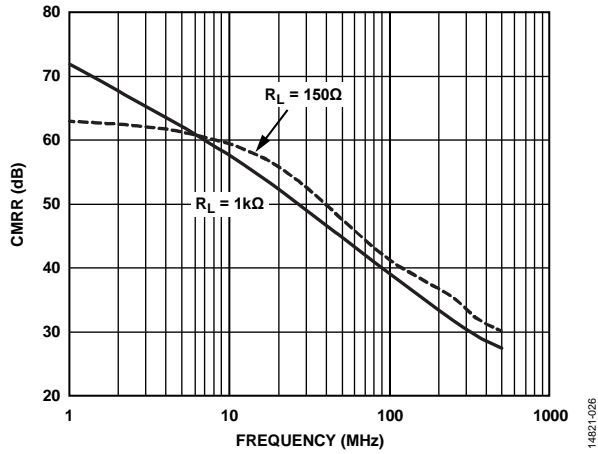

Figure 27. Common-Mode Rejection Ratio, CMRR ($R_S = 100 \Omega$)

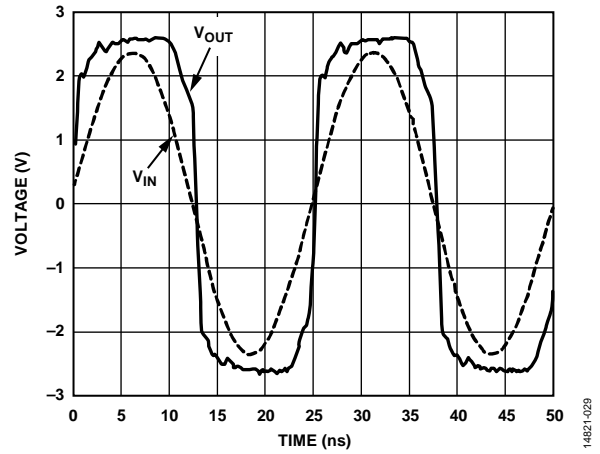

Figure 30. Overdrive Recovery Using Sinusoidal Input Waveform $R_L = 150 \Omega$ ($A_V = 10 \text{ dB}$, at 5V Supplies)

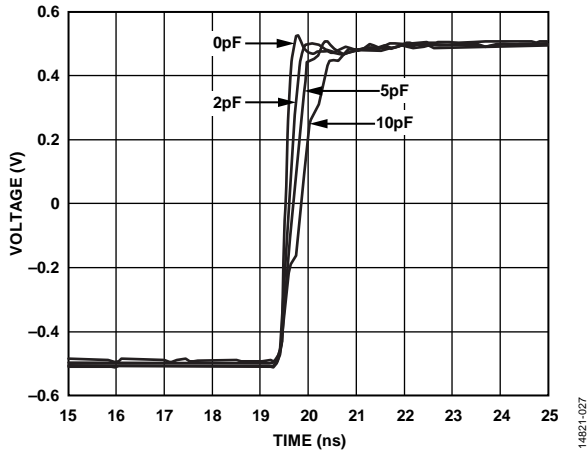

Figure 28. Transient Response Under Capacitive Loading ($R_L = 150 \Omega$, $C_L = 0 \text{ pF}, 2 \text{ pF}, 5 \text{ pF}, 10 \text{ pF}$)

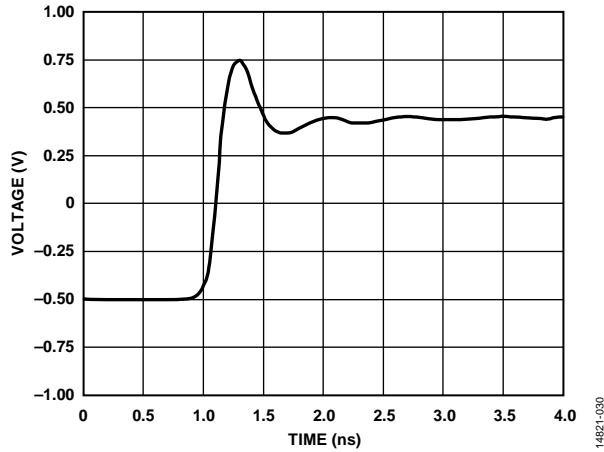

Figure 31. Large Signal Transient Response for a 1 V p-p Output Step ($A_V = 10 \text{ dB}$, $R_{IP} = 25 \Omega$)

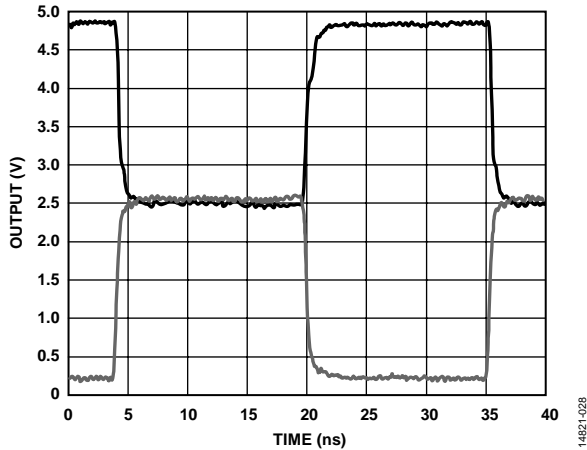

Figure 29. 2x Output Overdrive Recovery ($R_L = 150 \Omega$, $A_V = 10 \text{ dB}$)

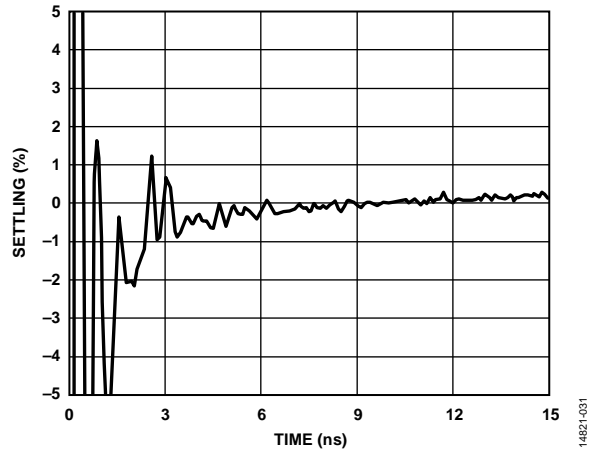

Figure 32. 1% Settling Time for a 2 V p-p Step ($A_V = 10 \text{ dB}$, $R_L = 150 \Omega$)

OUTLINE DIMENSIONS

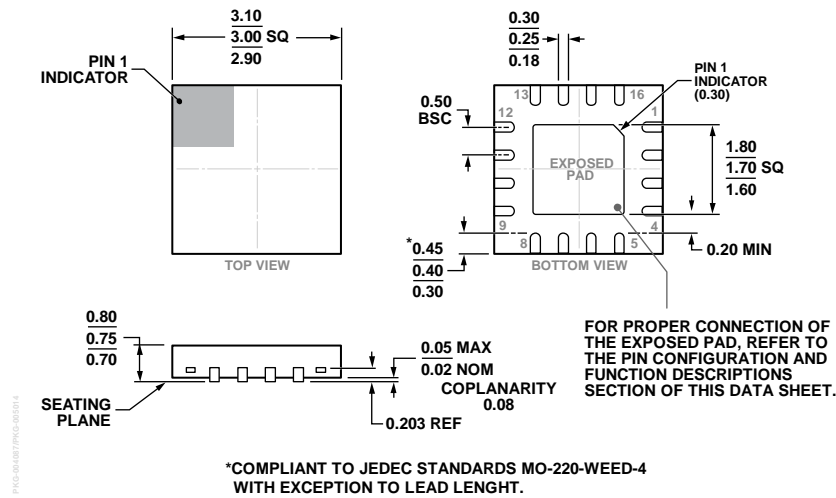

Figure 33. 16-Lead Lead Frame Chip Scale Package [LFCSP]
 3 mm × 3 mm Body and 0.75 mm Package Height
 (CP-16-33)
 Dimensions shown in millimeters

ORDERING GUIDE

Model ¹	Temperature Range	Package Description	Package Option	Branding
AD8351SCPZ-EP-R7	-55°C to +105°C	16-Lead Lead Frame Chip Scale Package [LFCSP]	CP-16-33	Q26

¹ Z = RoHS Compliant Part.

Компания «Океан Электроники» предлагает заключение долгосрочных отношений при поставках импортных электронных компонентов на взаимовыгодных условиях!

Наши преимущества:

- Поставка оригинальных импортных электронных компонентов напрямую с производств Америки, Европы и Азии, а так же с крупнейших складов мира;
- Широкая линейка поставок активных и пассивных импортных электронных компонентов (более 30 млн. наименований);
- Поставка сложных, дефицитных, либо снятых с производства позиций;
- Оперативные сроки поставки под заказ (от 5 рабочих дней);
- Экспресс доставка в любую точку России;
- Помощь Конструкторского Отдела и консультации квалифицированных инженеров;
- Техническая поддержка проекта, помощь в подборе аналогов, поставка прототипов;
- Поставка электронных компонентов под контролем ВП;
- Система менеджмента качества сертифицирована по Международному стандарту ISO 9001;
- При необходимости вся продукция военного и аэрокосмического назначения проходит испытания и сертификацию в лаборатории (по согласованию с заказчиком);
- Поставка специализированных компонентов военного и аэрокосмического уровня качества (Xilinx, Altera, Analog Devices, Intersil, Interpoint, Microsemi, Actel, Aeroflex, Peregrine, VPT, Syfer, Eurofarad, Texas Instruments, MS Kennedy, Miteq, Cobham, E2V, MA-COM, Hittite, Mini-Circuits, General Dynamics и др.);

Компания «Океан Электроники» является официальным дистрибьютором и эксклюзивным представителем в России одного из крупнейших производителей разъемов военного и аэрокосмического назначения «**JONHON**», а так же официальным дистрибьютором и эксклюзивным представителем в России производителя высокотехнологичных и надежных решений для передачи СВЧ сигналов «**FORSTAR**».



JONHON

«**JONHON**» (основан в 1970 г.)

Разъемы специального, военного и аэрокосмического назначения:

(Применяются в военной, авиационной, аэрокосмической, морской, железнодорожной, горно- и нефтедобывающей отраслях промышленности)

«**FORSTAR**» (основан в 1998 г.)

ВЧ соединители, коаксиальные кабели,
кабельные сборки и микроволновые компоненты:

(Применяются в телекоммуникациях гражданского и специального назначения, в средствах связи, РЛС, а так же военной, авиационной и аэрокосмической отраслях промышленности).



Телефон: 8 (812) 309-75-97 (многоканальный)

Факс: 8 (812) 320-03-32

Электронная почта: ocean@oceanchips.ru

Web: <http://oceanchips.ru/>

Адрес: 198099, г. Санкт-Петербург, ул. Калинина, д. 2, корп. 4, лит. А