

# ILB IB 24 DI8 DO8

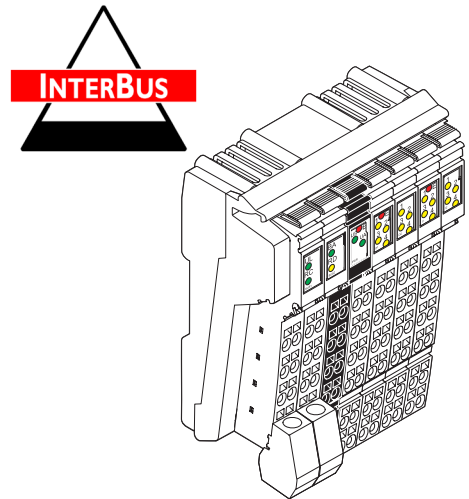

## Inline Block IO Module for INTERBUS With Eight Digital Inputs and Eight Digital Outputs

### AUTOMATIONWORX

Data Sheet  
6892\_en\_04

© PHOENIX CONTACT - 03/2007

## Description

The ILB IB 24 DI8 DO8 module is designed for use within an INTERBUS network. It is used to acquire and output digital signals.

### INTERBUS Features

- Remote bus connection via Inline connector
- Transmission speed 500 kbps
- Diagnostic and status indicators

### Input Features

- Connections for eight digital sensors
- Connection of sensors in 2 and 3-wire technology
- Maximum permissible load current per sensor: 250 mA
- Maximum permissible load current from the sensor supply: 2.0 A
- Diagnostic and status indicators

### Output Features

- Connections for eight digital actuators
- Connection of actuators in 2 and 3-wire technology
- Nominal current per output: 0.5 A
- Total current of all outputs: 4 A
- Short-circuit and overload protected outputs
- Diagnostic and status indicators



Please refer to the "Mounting and Removing Inline Block IO Modules" application note (see "Ordering Data" on page 2).



Make sure you always use the latest documentation.  
It can be downloaded at [www.download.phoenixcontact.com](http://www.download.phoenixcontact.com).  
A conversion table is available on the Internet at  
[www.download.phoenixcontact.com/general/7000\\_en\\_00.pdf](http://www.download.phoenixcontact.com/general/7000_en_00.pdf).

## Ordering Data

### Product

Description	Type	Order No.	Pcs./Pkt.
Inline Block IO module for INTERBUS with eight digital inputs and eight digital outputs	ILB IB 24 DI8 DO8	2862372	1

### Accessories: Connectors as Replacement Item

Description	Type	Order No.	Pcs./Pkt.
Shield connector for INTERBUS connection (color print)	IB IL SCN-6 SHIELD-CP	2863151	5
Connector for the supply (color print)	ILB SCN-12-PWR IN-CP	2863164	10
Connector, with color print, for digital 4-channel or 16-channel Inline output terminals	IB IL SCN-12-OCF	2727624	10
Connector, with color print, for digital 4-channel or 16-channel Inline input terminals	IB IL SCN-12-ICP	2727611	10

### Accessories: Other

Description	Type	Order No.	Pcs./Pkt.
Recommended end clamp; placed both to the right and left of the module to secure it on the DIN rail	CLIPFIX 35-5	3022276	50

### Documentation

Description	Type	Order No.	Pcs./Pkt.
"Mounting and Removing Inline Block IO Modules" application note	AH ILB INSTALLATION	9014931	1
"INTERBUS Addressing" data sheet	DB GB IBS SYS ADDRESS	9000990	1
"General Introduction to the INTERBUS System" user manual	IBS SYS INTRO G4 UM E	2745211	1

## Technical Data

### General Data

Housing dimensions with connectors (width x height x depth)	95 mm x 55 mm x 141 mm
Weight	350 g (with connectors)
Operating mode	Process data mode with 1 byte
Transmission speed	500 kbps
Type of sensor and actuator connection	2 and 3-wire technology

### Housing Dimensions

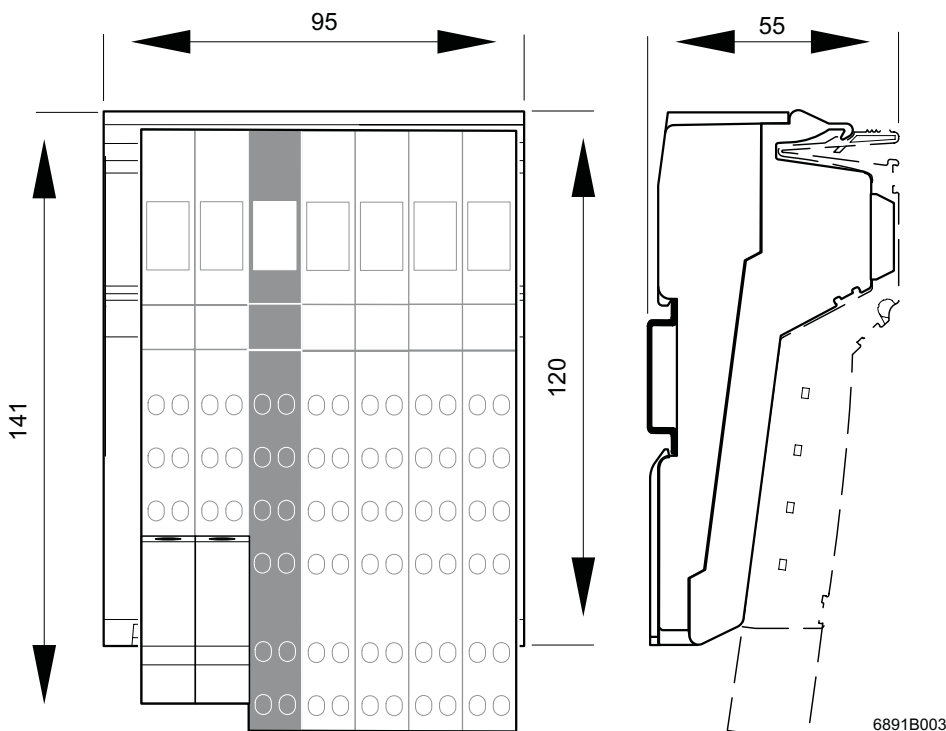

Figure 1 Housing dimensions of the module (dimensions in mm)

### Ambient Conditions

Regulations	Developed according to VDE 0160/EN 50178/IEC 62103, UL 508
Ambient temperature (operation)	-25°C to +60°C
Ambient temperature (storage/transport)	-25°C to +85°C
Humidity (operation/storage/transport)	10% to 95% according to EN 61131-2
Air pressure (operation)	80 kPa to 108 kPa (up to 2000 m above sea level)
Air pressure (storage/transport)	66 kPa to 108 kPa (up to 3500 m above sea level)
Degree of protection according to IEC 60529	IP20
Class of protection	Class 3 according to VDE 0106/IEC 60536
Air and creepage distances	According to DIN VDE 0110/IEC 60664, IEC 60664A, DIN VDE 0160/EN 50178/IEC 62103
Housing material	Plastic, PVC-free, PBT, self-extinguishing (V0)
Pollution degree according to EN 60664-1/IEC 60664-1, EN 61131-2/IEC 61131-2	2; condensation not permitted during operation
Surge voltage class	II

**Electrical Isolation/Isolation of the Voltage Areas**

Test Distance	Test Voltage
Incoming remote bus / outgoing remote bus	500 V AC, 50 Hz, 1 min
Incoming remote bus / I/O	500 V AC, 50 Hz, 1 min
Incoming remote bus / functional earth ground	500 V AC, 50 Hz, 1 min
Outgoing remote bus / I/O	500 V AC, 50 Hz, 1 min
Outgoing remote bus / functional earth ground	500 V AC, 50 Hz, 1 min
I/O / functional earth ground	500 V AC, 50 Hz, 1 min

**Mechanical Requirements**

Vibration test, sinusoidal vibrations according to EN 60068-2-6/IEC 60068-2-6	5g load, 2.5 hours in each space direction
Shock test according to EN 60068-2-27/IEC 60068-2-27	25g load for 11 ms, half sinusoidal wave, 3 shocks in each space direction and orientation
Broadband noise according to EN 60068-2-64/IEC 60068-2-64	0.78g load, 2.5 hours in each space direction

**Conformance With EMC Directive 89/336/EEC**

**Noise Immunity Test According to EN 61000-6-2**

Electrostatic discharge (ESD)	EN 61000-4-2 IEC 61000-4-2	Criterion B 6 kV contact discharge 8 kV air discharge
Electromagnetic fields	EN 61000-4-3 IEC 61000-4-3	Criterion A Field strength: 10 V/m
Fast transients (burst)	EN 61000-4-4/ IEC 61000-4-4	Criterion B Remote bus: 2 kV Power supply: 2 kV I/O cables: 2 kV Criterion A All interfaces: 1 kV
Surge voltage	EN 61000-4-5 IEC 61000-4-5	Criterion B DC supply lines: $\pm 0.5$ kV/ $\pm 1.0$ kV (symmetrical/asymmetrical) Signal cables: $\pm 0.5$ kV/ $\pm 0.5$ kV (symmetrical/asymmetrical)
Conducted interference	EN 61000-4-6 IEC 61000-4-6	Criterion A Test voltage 10 V

**Noise Emission Test According to EN 61000-6-4**

Noise emission of housing	EN 55022	Class B (residential)
---------------------------	----------	-----------------------

**Interface: INTERBUS**

Incoming remote bus	Copper cable (RS-422), connected with Inline shield connector; supply electrically isolated; shielding connected with a capacitor to functional earth ground
Outgoing remote bus	Copper cable (RS-422), connected with Inline shield connector; supply electrically isolated; shielding directly connected to functional earth ground
Recommended cable lengths	See INTERBUS system data in the IBS SYS INTRO G4 UM E user manual

**24 V Module Supply (Communications Power, Sensor Supply, and Actuator Supply;  $U_L$ ,  $U_S$ , and  $U_A$ )**

Nominal value	24 V DC
Tolerance	-15%/+20% according to EN 61131-2
Ripple	±5% according to EN 61131-2
Permissible range	19.2 V to 30.0 V
Current consumption at $U_L$	80 mA
Current consumption at $U_S$	2 A
Current consumption at $U_A$	4 A
Safety equipment for communications power	Surge protection and protection against polarity reversal
Safety equipment for the sensor supply	Surge, overload and short-circuit protection
Safety equipment for the actuator supply	Surge protection
Connection	Via power connectors

**Digital Outputs**

Number	8
Connection method for actuators	2 and 3-wire technology
Nominal output voltage $U_{OUT}$	24 V DC
Differential voltage at $I_{nom}$	≤ 1 V
Nominal current $I_{nom}$ per channel	0.5 A
Total current	1 x 4 A
Protection	Short-circuit and overload protection
Nominal load	
Ohmic	48 Ω/12 W
Lamp	12 W
Inductive	12 VA (1.2 H, 50 Ω)
Switching frequency with nominal inductive load	0.5 Hz (1.2 H, 50 Ω), maximum
Overload response	Auto restart
Response with inductive overload	Output may be damaged
Reverse voltage protection against short pulses	Protected against reverse voltages
Resistance to permanently applied reverse voltages	Protected against reverse voltages, permissible current 2 A, maximum
Validity of output data after connecting the 24 V supply voltage (power up)	1 ms, typical
Response upon power down	The output follows the supply voltage without delay.
Limitation of the voltage induced on circuit interruption	-30.0 V, approximately
One-time unsolicited energy	1 J, maximum
Protective circuit type	Integrated free running circuit in the output chip
Overcurrent shutdown	0.7 A, minimum
Maximum output current when switched off	10 μA



When not loaded, a voltage can be measured even at an output that is not set.

## Digital Inputs

Number	8
Connection method for sensors	2 and 3-wire technology
Input design	According to EN 61131-2 Type 1
Definition of switching thresholds	
Maximum low-level voltage	$U_{Lmax} < 5 \text{ V}$
Minimum high-level voltage	$U_{Hmin} > 15 \text{ V}$
Common potentials	Sensor supply $U_S$ , ground
Nominal input voltage $U_{IN}$	24 V DC
Permissible range	$-30 \text{ V} < U_{IN} < +30 \text{ V DC}$
Nominal input current for $U_{IN}$	5 mA, typical
Current flow	Linear in the range $1 \text{ V} < U_{IN} < 30 \text{ V}$
Delay time	$\leq 500 \text{ } \mu\text{s}$
Permissible cable length to the sensor	100 m
Use of AC sensors	AC sensors in the voltage range $< U_{IN}$ are limited in application

## Power Dissipation

### Formula to Calculate the Power Dissipation of the Electronics

$$P_{TOT} = 1.7 \text{ W} + I_S^2 \times 0.06 \text{ } \Omega + \sum_{i=1}^n (0.1 \text{ W} + I_{Li}^2 \times 0.28 \text{ } \Omega) + \sum_{j=1}^m 0.12 \text{ W}$$

Where

$P_{TOT}$	Total power dissipation of the module
$i$	Index
$n$	Number of set outputs ( $n = 1$ to $8$ )
$I_{Li}$	Load current of the output $i$
$j$	Index
$m$	Number of set inputs ( $m = 1$ to $8$ )
$I_S$	Current from the sensor supply

## Limitation of Simultaneity, Derating

No limitation of simultaneity, no derating

## Approvals

For the latest approvals, please visit [www.download.phoenixcontact.com](http://www.download.phoenixcontact.com).



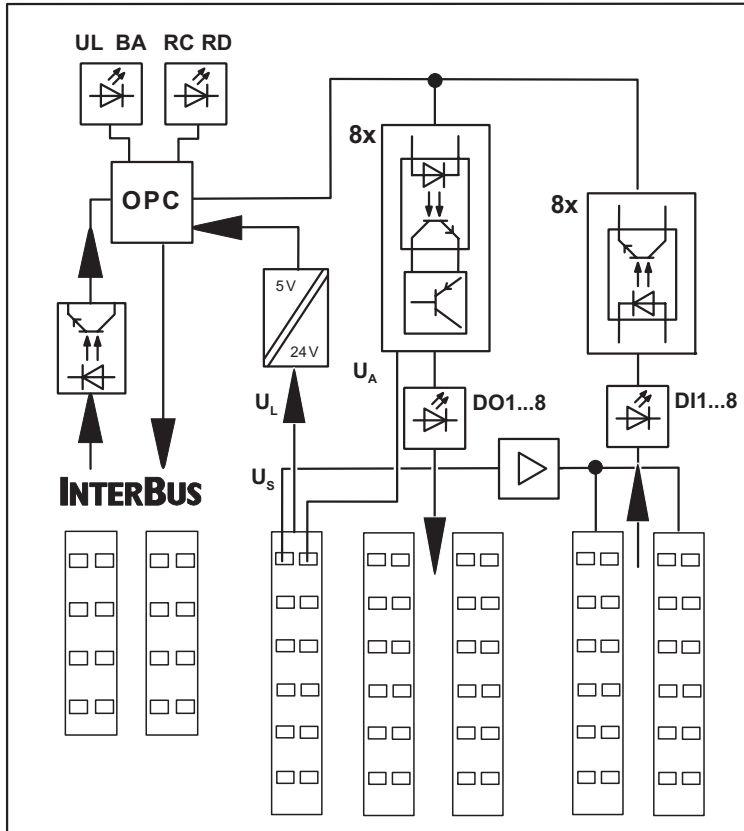



### Internal Circuit Diagram



6892B002

Figure 2 Internal wiring of the terminal points

Key:

-  LED
-  Protocol chip (bus logic)
-  Power supply unit with electrical isolation
-  Optocoupler
-  Short-circuit-proof output
-  Short-circuit-proof sensor supply

### Local Diagnostic and Status Indicators

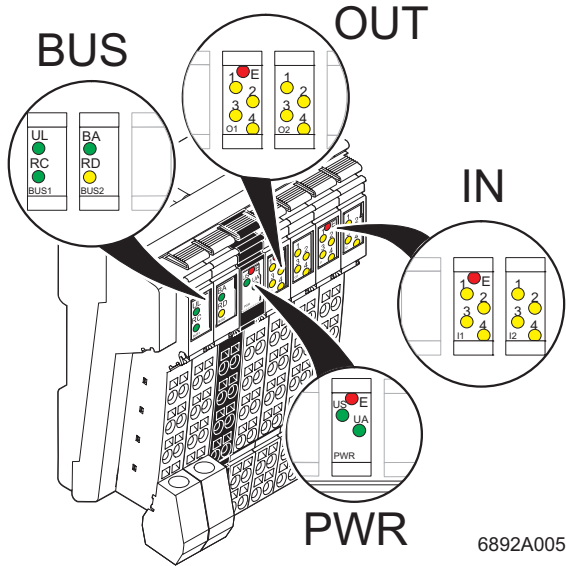

Figure 3 Diagnostic and status indicators of the ILB IB 24 DI8 DO8 module

Designation	Color	Meaning
<b>BUS</b>		
UL	Green	Communications power
RC	Green	Remote bus cable check
BA	Green	Bus active
RD	Yellow	Outgoing remote bus disabled
<b>PWR</b>		
E	Red	Undervoltage sensor supply $U_S$
US	Green	Sensor supply (connector 6 and connector 7 for sensors)
UA	Green	Actuator supply (connector 4 and connector 5 for actuators)
<b>OUT</b>		
E	Red	Short circuit or overload at one of the outputs
1 - 4	Yellow	Status indicators of the outputs
<b>IN</b>		
E	Red	Short circuit or overload of the sensor supply
1 - 4	Yellow	Status indicators of the inputs



If the error LED (E) of the group of eight outputs lights up (connector 4 and connector 5), this indicates that a short circuit or overload is present at one or more of the outputs in this group.



### Connecting INTERBUS, the Supply, Actuators, and Sensors

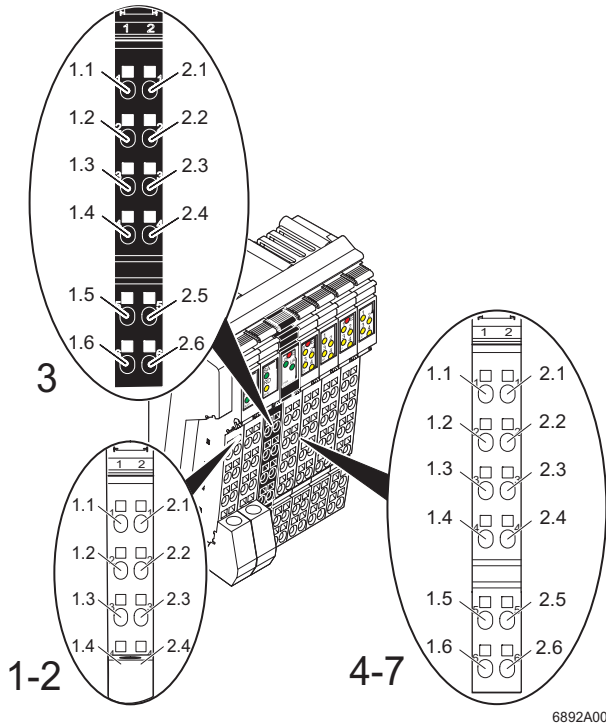

Figure 4 Terminal point assignment of the connectors

#### Terminal Point Assignment of INTERBUS Connectors (Connectors 1 and 2 in Figure 4)

Terminal Point	Assignment	Remark/Wire Color in the INTERBUS Standard Cable	
<b>Connector 1 (BUS 1) Incoming Remote Bus</b>			
1.1	DO1	Receive	Green
2.1	DO1	Receive	Yellow
1.2	DI1	Transmit	Pink
2.2	DI1	Transmit	Gray
1.3	F-GND	Reference potential	Brown
2.3			Not used
1.4, 2.4	Shield	Shield potential is connected with a capacitor to functional earth ground (FE) of the potential jumper.	
<b>Connector 2 (BUS 2) Outgoing Remote Bus</b>			
1.1	DO2	Transmit	Green
2.1	DO2	Transmit	Yellow
1.2	DI2	Receive	Pink
2.2	DI2	Receive	Gray
1.3	R-GND	Reference potential	Brown
2.3			Not used
1.4, 2.4	Shield	Shield potential is connected directly to functional earth ground (FE) of the potential jumper.	

**Terminal Point Assignment of the Power Connector  
(Connector 3 in Figure 4 on page 9)**

Terminal Point	Assignment
<b>Connector 3 (PWR)</b>	
1.1	24 V sensor supply $U_S$
2.1	24 V actuator supply $U_A$
1.2, 2.2	24 V communications power $U_L$
1.3, 2.3	GND
1.4, 2.4	FE
1.5, 2.5	24 V communications power $U_L$
1.6, 2.6	GND



The terminal points for GND and  $U_L$  can have a total current of 8 A per terminal point. The maximum current carrying capacity of 8 A must not be exceeded.



The supply points have the same ground potential. All ground supplies on a module are electrically connected with one another. They are jumpered via the power connector and the module, see "Connection example" on page 11.

**Terminal Point Assignment of Output Connectors  
(Connectors 4 and 5 in Figure 4 on page 9)**

Terminal Point		Assignment
Connector 4 (O1)	Connector 5 (O2)	
1.1, 2.1	1.1, 2.1	Signal output (OUT)
1.2, 2.2	1.2, 2.2	Ground contact (GND) for 2 and 3-wire termination
1.3, 2.3	1.3, 2.3	FE connection for 3-wire termination
1.4, 2.4	1.4, 2.4	Signal output (OUT)
1.5, 2.5	1.5, 2.5	Ground contact (GND) for 2 and 3-wire termination
1.6, 2.6	1.6, 2.6	FE connection for 3-wire termination

**Terminal Point Assignment of Input Connectors  
(Connectors 6 and 7 in Figure 4 on page 9)**

Terminal Point		Assignment
Connector 6 (I1)	Connector 7 (I2)	
1.1, 2.1	1.1, 2.1	Signal input (IN)
1.2, 2.2	1.2, 2.2	Segment voltage $U_S$ for 2 and 3-wire termination
1.3, 2.3	1.3, 2.3	Ground contact (GND) for 3-wire termination
1.4, 2.4	1.4, 2.4	Signal input (IN)
1.5, 2.5	1.5, 2.5	Segment voltage $U_S$ for 2 and 3-wire termination
1.6, 2.6	1.6, 2.6	Ground contact (GND) for 3-wire termination

### Connection Example

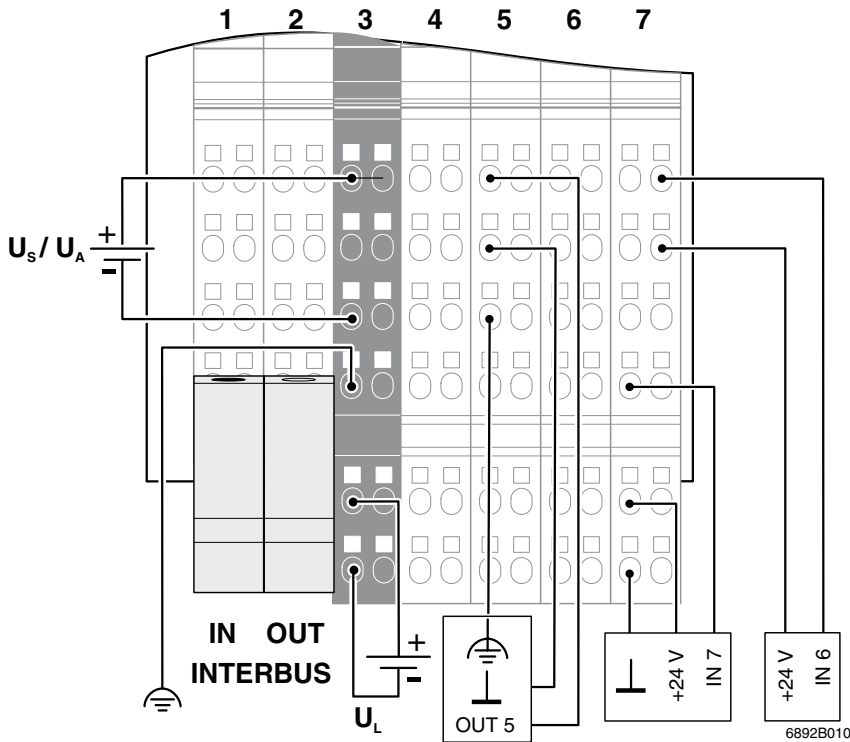

Figure 5 Connection example



The numbers above the module illustration identify the connector slots.



When connecting the actuators and sensors, observe the assignment of the terminal points to the process data (see page 12).



The module has an FE spring (metal clip) on the bottom of the electronics base. This spring creates an electrical connection to the DIN rail. Use grounding terminals to connect the DIN rail to protective earth ground. The module is grounded when it is snapped onto the DIN rail.  
To ensure reliable functional earth grounding of the module even when the DIN rail is dirty or the metal clip is damaged, Phoenix Contact also recommends grounding the module via one of the FE terminal points.

### Programming Data

ID code	03 <sub>hex</sub> (03 <sub>dec</sub> )
Length code	81 <sub>hex</sub>
Process data channel	8 bits
Input address area	1 byte
Output address area	1 byte
Parameter channel (PCP)	0 byte
Register length (bus)	1 byte

## Process Data



For the assignment of the illustrated (byte.bit) view to your control or computer system, please refer to the DB GB IBS SYS ADDRESS data sheet.

### Assignment of Terminal Points to the OUT Process Data Byte (Slots 4 and 5)

(Byte.bit) view	Byte	Byte 0							
	Bit	7	6	5	4	3	2	1	0
Module	Slot	5 (O2)				4 (O1)			
	Terminal point (signal)	2.4	1.4	2.1	1.1	2.4	1.4	2.1	1.1
	Terminal point (GND)	2.5	1.5	2.2	1.2	2.5	1.5	2.2	1.2
	Terminal point (FE connection)	2.6	1.6	2.3	1.3	2.6	1.6	2.3	1.3
Status indicator	Slot	5 (O2)				4 (O1)			
	LED	4	3	2	1	4	3	2	1

### Assignment of Terminal Points to the IN Process Data Byte (Slots 6 and 7)

(Byte.bit) view	Byte	Byte 0							
	Bit	7	6	5	4	3	2	1	0
Module	Slot	7 (I2)				6 (I1)			
	Terminal point (signal)	2.4	1.4	2.1	1.1	2.4	1.4	2.1	1.1
	Terminal point (24 V)	2.5	1.5	2.2	1.2	2.5	1.5	2.2	1.2
	Terminal point (GND)	2.6	1.6	2.3	1.3	2.6	1.6	2.3	1.3
Status indicator	Slot	7 (I2)				6 (I1)			
	LED	4	3	2	1	4	3	2	1

## Diagnostics

### Error Table With Diagnostic Data and Status Indicators

Error Type	Diagnostic Data	Status Indicators
Sensor voltage $U_S$ too low	I/O error message	US LED is off E (PWR) LED is red
Short circuit of sensor supply	I/O error message	E (IN) LED of the sensor supply is red
Actuator supply $U_A$ too low	No response	UA LED is off
Short circuit of a digital output	I/O error message	E (OUT) LED is red

© PHOENIX CONTACT 03/2007

Компания «Океан Электроники» предлагает заключение долгосрочных отношений при поставках импортных электронных компонентов на взаимовыгодных условиях!

Наши преимущества:

- Поставка оригинальных импортных электронных компонентов напрямую с производств Америки, Европы и Азии, а так же с крупнейших складов мира;
- Широкая линейка поставок активных и пассивных импортных электронных компонентов (более 30 млн. наименований);
- Поставка сложных, дефицитных, либо снятых с производства позиций;
- Оперативные сроки поставки под заказ (от 5 рабочих дней);
- Экспресс доставка в любую точку России;
- Помощь Конструкторского Отдела и консультации квалифицированных инженеров;
- Техническая поддержка проекта, помощь в подборе аналогов, поставка прототипов;
- Поставка электронных компонентов под контролем ВП;
- Система менеджмента качества сертифицирована по Международному стандарту ISO 9001;
- При необходимости вся продукция военного и аэрокосмического назначения проходит испытания и сертификацию в лаборатории (по согласованию с заказчиком);
- Поставка специализированных компонентов военного и аэрокосмического уровня качества (Xilinx, Altera, Analog Devices, Intersil, Interpoint, Microsemi, Actel, Aeroflex, Peregrine, VPT, Syfer, Eurofarad, Texas Instruments, MS Kennedy, Miteq, Cobham, E2V, MA-COM, Hittite, Mini-Circuits, General Dynamics и др.);

Компания «Океан Электроники» является официальным дистрибьютором и эксклюзивным представителем в России одного из крупнейших производителей разъемов военного и аэрокосмического назначения «JONHON», а так же официальным дистрибьютором и эксклюзивным представителем в России производителя высокотехнологичных и надежных решений для передачи СВЧ сигналов «FORSTAR».



## JONHON

«JONHON» (основан в 1970 г.)

Разъемы специального, военного и аэрокосмического назначения:

(Применяются в военной, авиационной, аэрокосмической, морской, железнодорожной, горно- и нефтедобывающей отраслях промышленности)

«FORSTAR» (основан в 1998 г.)

ВЧ соединители, коаксиальные кабели, кабельные сборки и микроволновые компоненты:

(Применяются в телекоммуникациях гражданского и специального назначения, в средствах связи, РЛС, а так же военной, авиационной и аэрокосмической отраслях промышленности).



Телефон: 8 (812) 309-75-97 (многоканальный)

Факс: 8 (812) 320-03-32

Электронная почта: [ocean@oceanchips.ru](mailto:ocean@oceanchips.ru)

Web: <http://oceanchips.ru/>

Адрес: 198099, г. Санкт-Петербург, ул. Калинина, д. 2, корп. 4, лит. А