

IM Relay

- Slim line 10x6mm, low profile 5.65mm and min. board-space 60mm²
- Switching current 2/5A, switching power 60W/62.5VA and switching voltage 220VDC/250VAC
- Low coil power consumption, 140mW standard, 100mW for high sensitive version, 50mW for ultra high sensitive version and 100mW for bistable version
- High dielectric and surge capability up to 2500Vrms between open contacts and 2500Vrms between coil and contacts
- High mechanical shock resistance up to 50g functional

Typical applications

Telecommunication, access and transmission equipment, optical network terminals, modems, office and business equipment, consumer electronics, measurement and test equipment, industrial control, medical equipment, automotive applications, HVAC

Approvals

UL 508 File No. E 111441
Technical data of approved types on request

Contact Data	standard, C	D, I	P
	standard and high dielectric version	high current version	high contact stability version
Contact arrangement	2 form C, 2 CO		
Max. switching voltage	220VDC, 250VAC	220VDC, 250VAC	220VDC, 250VAC
Rated current	2A	5A	2A
Limiting continuous current	2A	5A	2A
Switching power	60W, 62.5VA		
Contact material	PdRu +Au	AgNi +Au	PdRu +Au
Contact style	covered twin cont.	covered twin cont.	covered twin cont.
	I: single contacts		
Minimum switching voltage	100µV		
Initial contact resistance	<50mΩ at 10mA/30mV I: < 100mΩ		
Thermoelectric potential	<10µV		
Operate time	typ. 1ms, max. 3ms		
Release time	typ. 1ms, max. 3ms		
without diode in parallel	typ. 3ms, max. 5ms		
with diode in parallel	typ. 1ms, max. 5ms		
Bounce time max.	typ. 1ms, max. 5ms		

Max. DC load breaking capacity

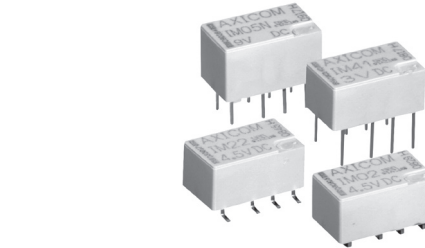
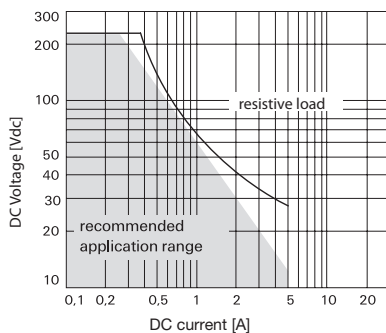

IM



Contact Data (continued)

Electrical endurance at contact application 0 (≤30mV/≤10mA)	min. 2.5x10 ⁶ operations
cable load open end resistive, 125VDC / 0.24A - 30W	min. 2.0x10 ⁶ operations
resistive, 220 VDC / 0.27A - 60W	min. 5x10 ⁵ operations
resistive, 250VAC / 0.25A - 62.5VA	min. 1x10 ⁵ operations
resistive, 30VDC / 1A - 30W	min. 5x10 ⁵ operations
resistive, 30VDC / 2A - 60W	min. 1x10 ⁵ operations
UL contact rating	30VDC, 2A, 60W, NO only 110VDC, 0.3A, 33W 220VDC, 0.27A, 60W 125VAC, 0.5A, 62.5W 250VAC, 0.25A, 62.5W
Mechanical endurance	10 ⁸ operations

Coil Data

Magnetic system	monostable, bistable
Coil voltage range	1.5 to 24VDC

Coil versions, standard version, monostable, 1 coil

Coil code	Rated voltage VDC	Operate voltage VDC	Release voltage VDC	Coil resistance Ω±10%	Rated coil power mW
00	1.5	1.13	0.15	16	140
08	2.4	1.80	0.24	41	140
01	3	2.25	0.30	64	140
02	4.5	3.38	0.45	145	140
03	5	3.75	0.50	178	140
04	6	4.50	0.60	257	140
05	9	6.75	0.90	579	140
06	12	9.00	1.20	1029	140
07	24	18.00	2.40	2880	200

All figures are given for coil without pre-energization, at ambient temperature +23°C

Coil operating range, standard version

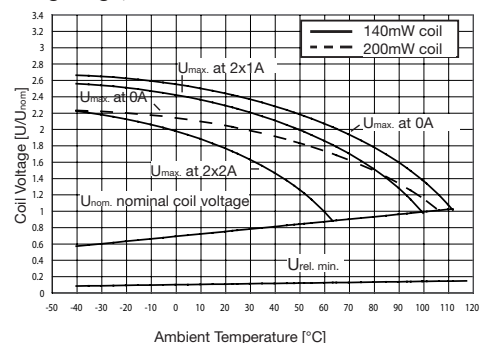

IM Relay (Continued)

Coil Data (continued)

Coil versions, sensitive version, monostable, 1 coil

Coil code	Rated voltage VDC	Operate voltage VDC	Release voltage VDC	Coil resistance $\Omega \pm 10\%$	Rated coil power mW
11	3	2.40	0.30	91	100
12	4.5	3.60	0.45	194	100
13	5	4.00	0.50	234	100
16	12	9.60	1.20	1315	110
17	24	19.20	2.40	4120	140

Coil versions, ultra high sensitive version, monostable, 1 coil

Coil code	Rated voltage VDC	Operate voltage VDC	Release voltage VDC	Coil resistance $\Omega \pm 10\%$	Rated coil power mW
21	3	2.55	0.30	180	50
22	4.5	3.83	0.45	405	50
23	5	4.25	0.50	500	50
26	12	10.20	1.20	2880	50

All figures are given for coil without pre-energization, at ambient temperature +23°C

Coil operating range, sensitive and ultra high sensitive coil

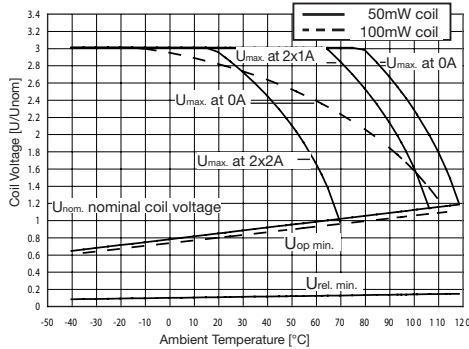

Coil versions, standard, bistable 1 coil

Coil code	Rated voltage VDC	Set voltage VDC	Reset voltage VDC	Coil resistance $\Omega \pm 10\%$	Rated coil power mW
40	1.5	1.13	-1.13	23	100
48	2.4	1.80	-1.80	58	100
41	3	2.25	-2.25	90	100
42	4.5	3.38	-3.38	203	100
43	5	3.75	-3.75	250	100
44	6	4.50	-4.50	360	100
45	9	6.75	-6.75	810	100
46	12	9.00	-9.00	1440	100
47	24	18.00	-18.00	2880	200

All figures are given for coil without pre-energization, at ambient temperature +23°C

Coil operating range, bistable 1 coil

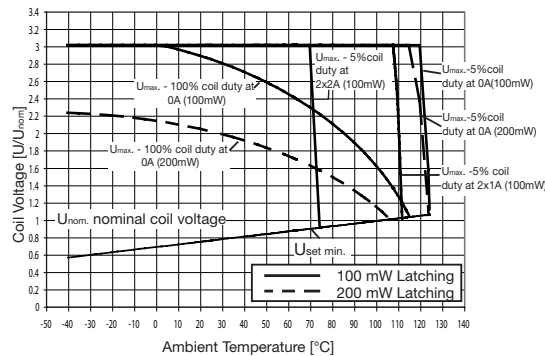

Insulation Data

	standard	C	D,P, I
	standard, sensitive, ultra high sensitive version	high dielectric version	high current, high contact stability version
Initial dielectric strength			
between open contacts	1000V _{rms}	1500V _{rms}	750V _{rms}
between contact and coil	1800V _{rms}	1800V _{rms}	1500V _{rms}
between adjacent contacts	1000V _{rms}	1800V _{rms}	750V _{rms}
Initial surge withstand voltage			
between open contacts	1500V	2500V	1000V
between contact and coil	2500V	2500V	2000V
between adjacent contacts	1500V	2500V	1000V
Initial insulation resistance			
between insulated elements	>10 ⁹ Ω	>10 ⁹ Ω	>10 ⁹ Ω
Capacitance			
between open contacts		max. 1pF	
between contact and coil		max. 2pF	
between adjacent contacts		max. 2pF	

RF Data

Isolation at 100MHz/900MHz	37.0dB/18.8dB
Insertion loss at 100MHz/900MHz	0.03dB/0.33dB
Voltage standing wave ratio (VSWR) at 100MHz/900MHz	1.06/1.49

Other Data

Material compliance: EU RoHS/ELV, China RoHS, REACH, Halogen content refer to the Product Compliance Support Center at www.te.com/customer-support/rohssupportcenter

Ambient temperature	-40°C to +85°C
Thermal resistance	<150K/W
Category of environmental protection	IEC 61810
	RT V - hermetically sealed
Vibration resistance (functional)	20g, 10 to 500Hz
Shock resistance (functional), half sinus 11ms	50g
Shock resistance (destructive), half sinus 0.5ms	500g
Mounting position	any
Weight	max. 0.75g
Resistance to soldering heat SMT	
IEC 60068-2-58	
Moisture sensitive level, JEDEC J-Std-020D	MSL3
related only to SMT relays	
packed in original dry-packs	
Ultrasonic cleaning	not recommended
Packaging/unit	
THT version	tube/50pcs., box/1000 pcs.
SMT version	reel/1000 pcs., box/1000 or 5000 pcs.

Terminal assignment

TOP view on relay

Monostable version
rest condition

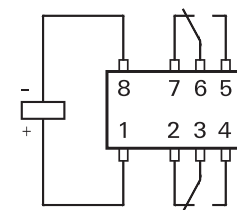

Bistable version, 1 coil
reset condition

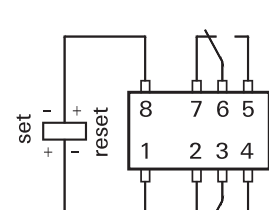

Contacts are shown in reset condition. Contact position might change during transportation and must be reset before use.

IM Relay (Continued)

Dimensions

THT version

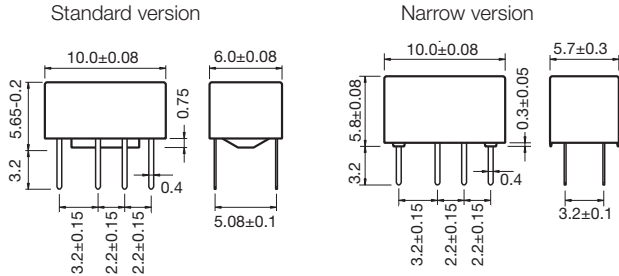

SMT version

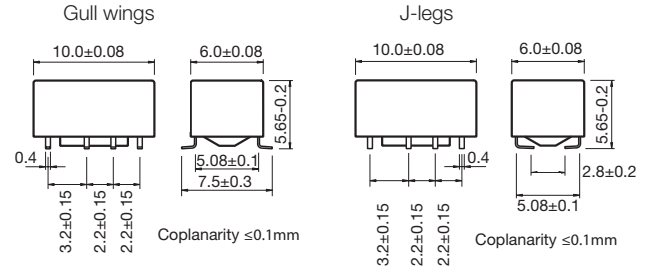

PCB layout

TOP view on component side of PCB

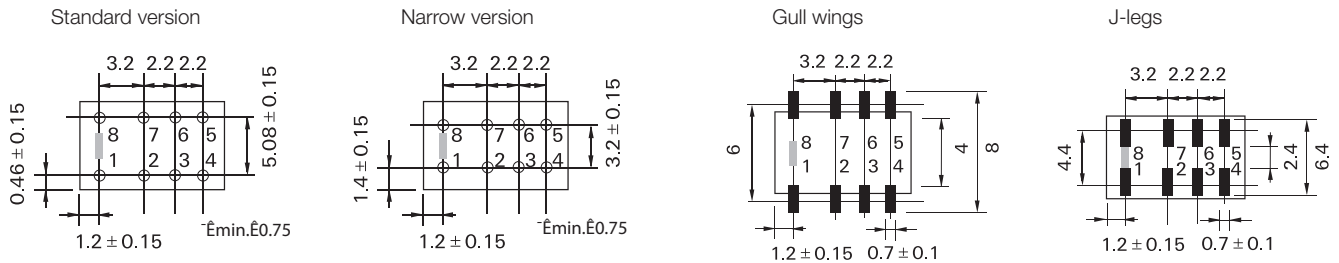

Processing

Recommended soldering conditions

Recommended reflow soldering profile IEC 61760-1

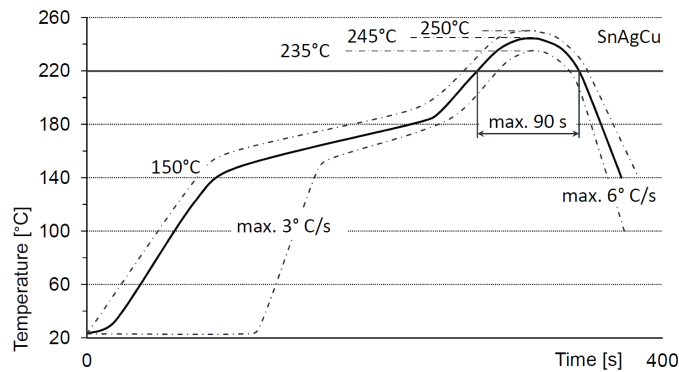

Resistance to soldering heat - reflow profile IEC 60068-2-58

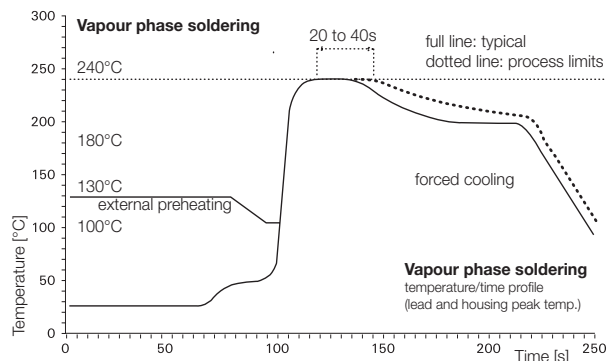
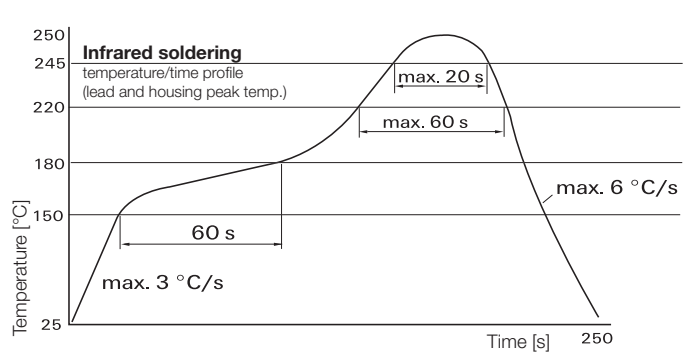

IM Relay (Continued)

Packing

Tube for THT version
50 relays per tube, 1000 relays per box

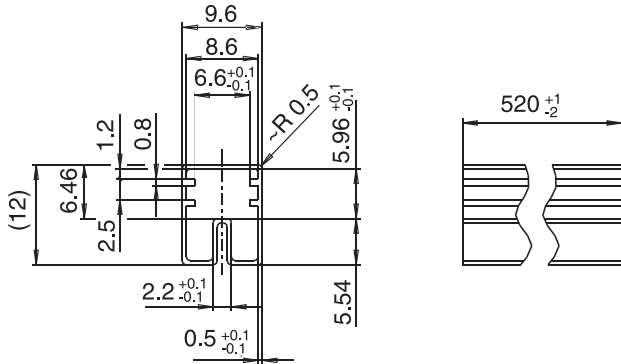

Tape and reel for SMT version
1000 relays per reel, 1000 or 5000 relays per box

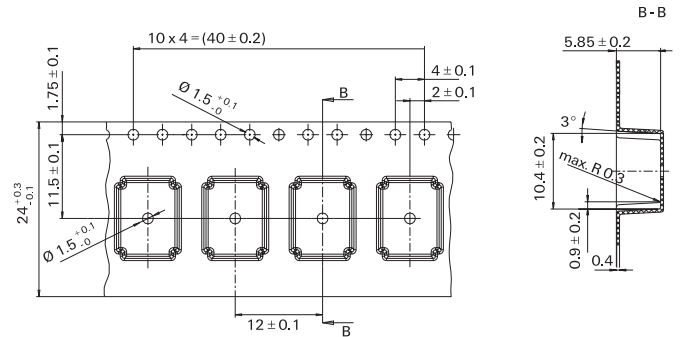

Reel dimensions

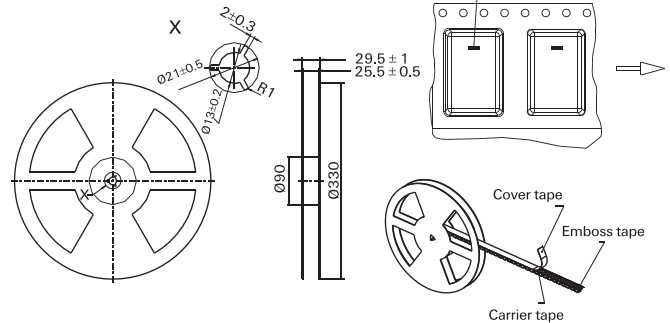

Product code structure

Typical product code

IM

03

G

R

Type

IM Signal Relays IM Series

Contact arrangement

Blank 2 form C, 2 CO

Coil

Coil code: please refer to coil versions table

Performance type

Blank Standard version

- I** High current version HVAC
- C** High dielectric version
- D** High current version
- P** High contact stability version

Terminals

- T** THT - standard
- N** THT - narrow version

- J** SMT - J-leg
- G** SMT - gull wing

Packing

S Tube

R Reel

IM Relay (Continued)

Product code	Arrangement	Perf. type	Coil	Coil type	Coil	Terminals	Part number
IM00GR	2 form C, 2 CO contacts	Standard	1.5VDC	Monostable	Standard	SMT gull wing	3-1462037-7
IM00JR						SMT J-leg	3-1462037-9
IM00NS						THT narrow	1-1462038-0
IM01GR			3VDC			SMT gull wing	1462037-1
IM01JR						SMT J-leg	4-1462037-0
IM01NS						THT narrow	1-1462038-1
IM01TS						THT standard	1462037-4
IM02GR			4.5VDC			SMT gull wing	1462037-9
IM02JR						SMT J-leg	1-1462037-1
IM02NS						THT narrow	1-1462038-2
IM03GR			5VDC			SMT gull wing	1-1462037-4
IM03JR						SMT J-leg	1-1462037-6
IM03NS						THT narrow	1-1462038-3
IM03TS						THT standard	1-1462037-8
IM04GR			6VDC			SMT gull wing	4-1462037-2
IM04JR						SMT J-leg	4-1462037-4
IM04NS						THT narrow	1-1462038-4
IM05GR			9VDC			SMT gull wing	3-1462037-4
IM05JR						SMT J-leg	4-1462037-5
IM05NS						THT narrow	1-1462038-5
IM05TS						THT standard	2-1462037-2
IM06GR			12VDC			SMT gull wing	2-1462037-3
IM06JR						SMT J-leg	4-1462037-6
IM06NS						THT narrow	1-1462038-6
IM07GR			24VDC			SMT gull wing	4-1462037-7
IM07JR						SMT J-leg	4-1462037-8
IM07NS						THT narrow	1-1462038-7
IM08GR			2.4VDC			SMT gull wing	6-1462039-3
IM11GR			3VDC		High sens.		9-1462038-5
IM12GR			4.5VDC				
IM13GR			5VDC				1462039-4
IM16GR			12VDC				1462039-5
IM17GR			24VDC				1462039-6
IM17TS						THT standard	4-1462039-6
IM21GR			3VDC		Ultra high sensitive	SMT gull wing	2-1462039-6
IM21TS						THT standard	1-1462039-5
IM22GR			4.5VDC			SMT gull wing	2-1462039-7
IM22TS						THT standard	2-1462039-8
IM23GR			5VDC			SMT gull wing	2-1462039-9
IM23TS						THT standard	3-1462039-0
IM26GR			12VDC			SMT gull wing	3-1462039-1
IM26TS						THT standard	3-1462039-2
IM40GR			1.5VDC	Bistable	Standard	SMT gull wing	5-1462037-1
IM40JR							
IM40NS						THT narrow	1-1462038-8
IM40TS						THT standard	5-1462037-0
IM41GR			3VDC			SMT gull wing	5-1462037-4
IM41JR						SMT J-leg	5-1462037-5
IM41NS						THT narrow	1-1462038-9
IM41TS						THT standard	5-1462037-3
IM42GR			4.5VDC			SMT gull wing	3-1462037-1
IM42JR						SMT J-leg	5-1462037-7
IM42NS						THT narrow	2-1462038-0
IM42TS						THT standard	5-1462037-6
IM43GR			5VDC			SMT gull wing	5-1462037-9
IM43JR						SMT J-leg	6-1462037-0
IM43NS						THT narrow	2-1462038-1
IM43TS						THT standard	5-1462037-8
IM44GR			6VDC			SMT gull wing	6-1462037-2
IM44JR						SMT J-leg	6-1462037-3
IM44NS						THT narrow	2-1462038-2
IM44TS						THT standard	6-1462037-1
IM45GR			9VDC			SMT gull wing	6-1462037-4
IM45JR						SMT J-leg	6-1462037-5
IM45NS						THT narrow	2-1462038-3
IM46GR			12VDC			SMT gull wing	6-1462037-7
IM46JR						SMT J-leg	6-1462037-8
IM46NS						THT narrow	2-1462038-4
IM46TS						THT standard	6-1462037-6
IM47GR			24VDC			SMT gull wing	7-1462037-0
IM47JR						SMT J-leg	7-1462037-1
IM47NS						THT narrow	2-1462038-5
IM47TS						THT standard	6-1462037-9
IM48GR			2.4VDC			SMT gull wing	1462039-8

IM Relay (Continued)

Product code	Arrangement	Perf. type	Coil	Coil type	Coil	Terminals	Part number
IM01CGR	2 form C	High	3VDC	Monostable	Standard	SMT gull wing	1462038-4
IM01CTS	2 CO	dielectric				THT standard	9-1462038-6
IM02CGR	contacts		4.5VDC			SMT gull wing	1462038-1
IM03CGR			5VDC				1462038-2
IM03CJR						SMT J-leg	4-1462039-8
IM03CTS						THT standard	4-1462039-7
IM05CGR			9VDC			SMT gull wing	1462038-3
IM06CGR			12VDC				9-1462037-9
IM06CJR						SMT J-leg	3-1462039-4
IM06CTS						THT standard	4-1462037-9
IM07CGR			24VDC			SMT gull wing	1462039-2
IM07CTS						THT standard	1462039-1
IM17CGR					High sens.	SMT gull wing	1462039-7
IM41CGR			3VDC	Bistable	Standard		4-1462039-2
IM42CGR			4.5VDC				4-1462039-1
IM43CGR			5VDC				9-1462038-7
IM02DGR		High	4.5VDC	Monostable	Standard		9-1462038-8
IM03DGR		current	5VDC				9-1462038-9
IM03DJR						SMT J-leg	3-1462039-3
IM05DGR			9VDC			SMT gull wing	1-1462039-7
IM06DGR			12VDC				1-1462039-8
IM06DJR						SMT J-leg	7-1462039-0
IM06DTS						THT standard	3-1462039-8
IM07DGR			24VDC			SMT gull wing	3-1462039-7
IM07DJR						SMT J-leg	7-1462039-4
IM07DTS						THT standard	7-1462039-2
IM22DTS			4.5VDC		U.h.sens.		7-1462039-6
IM41DGR			3VDC	Bistable	Standard	SMT gull wing	6-1462039-8
IM42DGR			4.5VDC				1-1462039-9
IM42DNS						THT narrow	1-1462039-6
IM46DNS			12VDC				1-1462039-2
IM47DJR			24VDC			SMT J-leg	7-1462039-5
IM48DGR			2.4VDC			SMT gull wing	1462039-9
IM49DGR			2VDC				2-1462039-2
IM48IGR			2.4VDC				1462047-1
IM49IGR			2VDC				1462047-4
IM02PGR		High	4.5VDC	Monostable	Standard		5-1462039-4
IM02PNS		contact				THT narrow	5-1462039-8
IM03PGR		stability	5VDC			SMT gull wing	5-1462039-5
IM03PJR						SMT J-leg	6-1462039-6
IM03PNS						THT narrow	5-1462039-9
IM06PGR			12VDC			SMT gull wing	5-1462039-6
IM06PNS						THT narrow	6-1462039-0
IM42PGR			4.5VDC	Bistable	Standard	SMT gull wing	5-1462039-7
IM42PNS						THT narrow	7-1462039-8
IM43PGR						SMT gull wing	7-1462039-3
IM46PNS			12VDC			THT narrow	6-1462039-1

Компания «Океан Электроники» предлагает заключение долгосрочных отношений при поставках импортных электронных компонентов на взаимовыгодных условиях!

Наши преимущества:

- Поставка оригинальных импортных электронных компонентов напрямую с производств Америки, Европы и Азии, а так же с крупнейших складов мира;
- Широкая линейка поставок активных и пассивных импортных электронных компонентов (более 30 млн. наименований);
- Поставка сложных, дефицитных, либо снятых с производства позиций;
- Оперативные сроки поставки под заказ (от 5 рабочих дней);
- Экспресс доставка в любую точку России;
- Помощь Конструкторского Отдела и консультации квалифицированных инженеров;
- Техническая поддержка проекта, помощь в подборе аналогов, поставка прототипов;
- Поставка электронных компонентов под контролем ВП;
- Система менеджмента качества сертифицирована по Международному стандарту ISO 9001;
- При необходимости вся продукция военного и аэрокосмического назначения проходит испытания и сертификацию в лаборатории (по согласованию с заказчиком);
- Поставка специализированных компонентов военного и аэрокосмического уровня качества (Xilinx, Altera, Analog Devices, Intersil, Interpoint, Microsemi, Actel, Aeroflex, Peregrine, VPT, Syfer, Eurofarad, Texas Instruments, MS Kennedy, Miteq, Cobham, E2V, MA-COM, Hittite, Mini-Circuits, General Dynamics и др.);

Компания «Океан Электроники» является официальным дистрибьютором и эксклюзивным представителем в России одного из крупнейших производителей разъемов военного и аэрокосмического назначения «JONHON», а так же официальным дистрибьютором и эксклюзивным представителем в России производителя высокотехнологичных и надежных решений для передачи СВЧ сигналов «FORSTAR».



JONHON

«JONHON» (основан в 1970 г.)

Разъемы специального, военного и аэрокосмического назначения:

(Применяются в военной, авиационной, аэрокосмической, морской, железнодорожной, горно- и нефтедобывающей отраслях промышленности)

«FORSTAR» (основан в 1998 г.)

ВЧ соединители, коаксиальные кабели, кабельные сборки и микроволновые компоненты:

(Применяются в телекоммуникациях гражданского и специального назначения, в средствах связи, РЛС, а так же военной, авиационной и аэрокосмической отраслях промышленности).



Телефон: 8 (812) 309-75-97 (многоканальный)

Факс: 8 (812) 320-03-32

Электронная почта: ocean@oceanchips.ru

Web: <http://oceanchips.ru/>

Адрес: 198099, г. Санкт-Петербург, ул. Калинина, д. 2, корп. 4, лит. А