

EE-SPW311/411

Through-beam Photomicrosensor with a sensing distance as long as 1 m.

- Easy operation monitoring with bright light indicator.
- Wide operating voltage range: 5 to 24 VDC
- Light modulation effectively reduces external light interference.
- Easy-to-wire connector assures ease of maintenance.





 Be sure to read *Safety Precautions* on page 3.



Ordering Information

Sensors

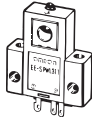
 Infrared light

| Appearance | Sensing method | Sensing distance | Output type | Output configuration | Model |
|--|-------------------|--|-------------|----------------------|------------------|
|  | Through-beam type |  1m | NPN output | Dark-ON | EE-SPW311 |
| | | | | Light-ON | EE-SPW411 |

* Both an EE-1006L Connector with Cable for the Emitter and an EE-1006D Connector with Cable for the Receiver are included with the Photomicrosensor. Refer to *Accessories* when using non-standard connectors, including Robot Cables and PNP Adapters.

Ratings and Specifications

| Item | Models | EE-SPW311, EE-SPW411 |
|---------------------------|--------|---|
| Sensing distance | | 1 m |
| Sensing object | | Opaque: 5 mm dia. min. |
| Directional angle | | 5 to 20° |
| Light source | | GaAs infrared LED (pulse lighting) with a peak wavelength of 940 nm |
| Indicator *1 | | Light indicator (red) |
| Supply voltage | | 5 (-5%) to 24 (+10%) VDC, ripple (p-p): 5% max. |
| Current consumption | | Emitter: 20 mA max., Receiver: 20 mA max. |
| Control output | | NPN open collector: Load power supply voltage: 5 to 24 VDC Load current: 100 mA max. OFF current: 0.5 mA max. 100 mA load current with a residual voltage of 0.8 V max. 10 mA load current with a residual voltage of 0.4 V max. |
| Response frequency *2 | | 100 Hz min. |
| Ambient illumination | | 3,000 lx max. with incandescent light on the surface of the receiver |
| Ambient temperature range | | Operating: -10 to +55°C Storage: -25 to +65°C |
| Ambient humidity range | | Operating: 5% to 85% Storage: 5% to 95% |
| Vibration resistance | | Destruction: 200 to 2,000 Hz (peak acceleration: 100 m/s ²) 1.5-mm double amplitude for 2 h (4-min periods) each in X, Y, and Z directions |
| Shock resistance | | Destruction: 500 m/s ² for 3 times each in X, Y, and Z directions |
| Degree of protection | | IEC IP60 |
| Connecting method | | Special connector (soldering not possible) |
| Weight (packaged) | | Approx. 8.8 g |
| Material | Case | Polybutylene phthalate (PBT) |
| | Lens | Polycarbonate |
| Accessories | | EE-1006L/D Connectors with Cables, Instruction Manual |

*1. The indicator is a GaP red LED (peak wavelength: 700 nm).
*2. The response frequency was measured by detecting the following rotating disk.

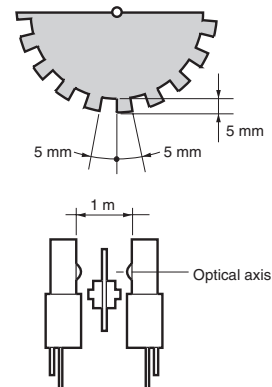

Engineering Data (Typical)

Receiver Output Excess Gain Vs. Sensing Distance Characteristics



Parallel Movement Characteristics

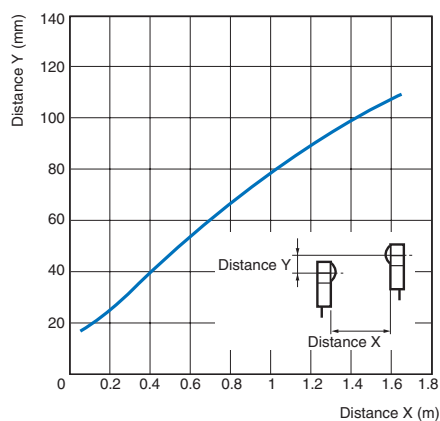

I/O Circuit Diagrams

NPN Output

| Model | Output configuration | Timing charts | Output circuit |
|-----------|----------------------|---------------|----------------|
| EE-SPW411 | Light-ON | | |
| EE-SPW311 | Dark-ON | | |

Safety Precautions

Refer to *Warranty and Limitations of Liability*.

⚠ WARNING

This product is not designed or rated for ensuring safety of persons either directly or indirectly. Do not use it for such purposes.



Precautions for Correct Use

Make sure that this product is used within the rated ambient environment conditions.

● Wiring

- Connection is made using a connector. Do not solder to the pins (leads).
- When extending the cable, use an extension cable with conductors having a total cross-section area of 0.3 mm². The total cable length must be less than 10 m.

● Axis Adjustment

- (1) Tentatively mount the emitter and receiver so that the center of each lens is in a single line.

Side view



Top view



- (2) Turn ON the emitter and receiver after making sure that they have been wired correctly. When power is turned ON, the light indicator on the receiver will light. Make sure that the light indicator is OFF when an object intercepts the optical axis and that the light indicator lights again when the object is removed.

- (3) Fix the position of the receiver (or emitter) securely, move the emitter (or receiver) horizontally and vertically to check the range in which the operation indicator is lit. Then locate the emitter (or receiver) in the center of the range and fix the position securely.



Dimensions

Tolerance class IT16 applies to dimensions in this datasheet unless otherwise specified.

Sensors

EE-SPW311
EE-SPW411

Emitter (EE-SPWL□11)

Receiver (EE-SPWD□11)

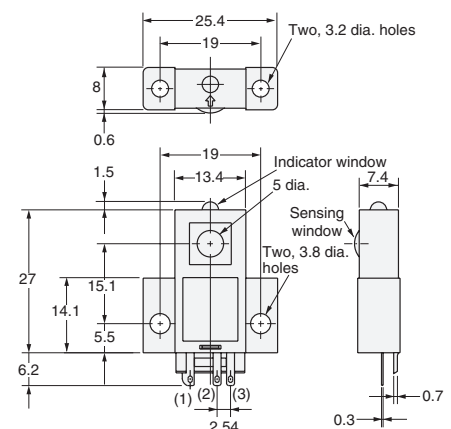
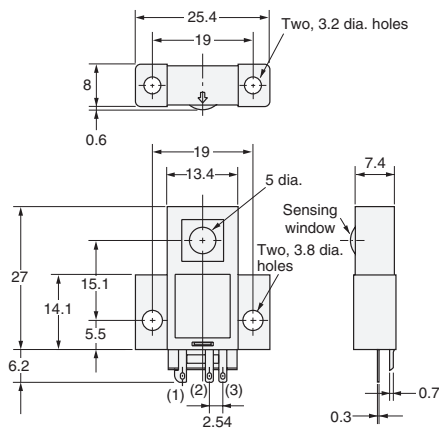
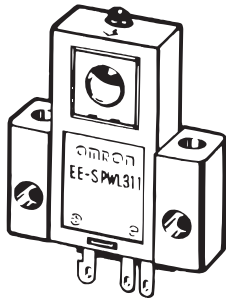

Terminal Arrangement

| | | |
|-----|-----|-----------|
| (1) | + | Vcc |
| (2) | --- | Vacant |
| (3) | - | GND (0 V) |

Terminal Arrangement

| | | |
|-----|-----|-----------|
| (1) | + | Vcc |
| (2) | OUT | OUTPUT |
| (3) | - | GND (0 V) |

Accessories (Included)

Connector with Cable for Emitter

EE-1006L

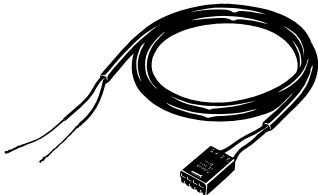

| | | |
|-----|-------|---|
| (1) | Brown | + |
| (4) | Blue | - |

Connector with Cable for Receiver

EE-1006D

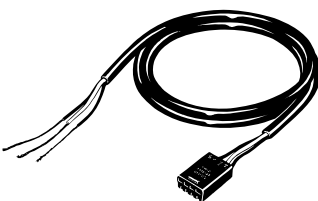

| | | |
|-----|-------|-----|
| (1) | Brown | + |
| (3) | Black | OUT |
| (4) | Blue | - |

Note: These cables can also be ordered separately.

* Refer to *Accessories* for details.

Read and Understand This Catalog

Please read and understand this catalog before purchasing the products. Please consult your OMRON representative if you have any questions or comments.

Warranty and Limitations of Liability

WARRANTY

OMRON's exclusive warranty is that the products are free from defects in materials and workmanship for a period of one year (or other period if specified) from date of sale by OMRON.

OMRON MAKES NO WARRANTY OR REPRESENTATION, EXPRESS OR IMPLIED, REGARDING NON-INFRINGEMENT, MERCHANTABILITY, OR FITNESS FOR PARTICULAR PURPOSE OF THE PRODUCTS. ANY BUYER OR USER ACKNOWLEDGES THAT THE BUYER OR USER ALONE HAS DETERMINED THAT THE PRODUCTS WILL SUITABLY MEET THE REQUIREMENTS OF THEIR INTENDED USE. OMRON DISCLAIMS ALL OTHER WARRANTIES, EXPRESS OR IMPLIED.

LIMITATIONS OF LIABILITY

OMRON SHALL NOT BE RESPONSIBLE FOR SPECIAL, INDIRECT, OR CONSEQUENTIAL DAMAGES, LOSS OF PROFITS OR COMMERCIAL LOSS IN ANY WAY CONNECTED WITH THE PRODUCTS, WHETHER SUCH CLAIM IS BASED ON CONTRACT, WARRANTY, NEGLIGENCE, OR STRICT LIABILITY.

In no event shall the responsibility of OMRON for any act exceed the individual price of the product on which liability is asserted.

IN NO EVENT SHALL OMRON BE RESPONSIBLE FOR WARRANTY, REPAIR, OR OTHER CLAIMS REGARDING THE PRODUCTS UNLESS OMRON'S ANALYSIS CONFIRMS THAT THE PRODUCTS WERE PROPERLY HANDLED, STORED, INSTALLED, AND MAINTAINED AND NOT SUBJECT TO CONTAMINATION, ABUSE, MISUSE, OR INAPPROPRIATE MODIFICATION OR REPAIR.

Application Considerations

SUITABILITY FOR USE

OMRON shall not be responsible for conformity with any standards, codes, or regulations that apply to the combination of products in the customer's application or use of the products.

At the customer's request, OMRON will provide applicable third party certification documents identifying ratings and limitations of use that apply to the products. This information by itself is not sufficient for a complete determination of the suitability of the products in combination with the end product, machine, system, or other application or use.

The following are some examples of applications for which particular attention must be given. This is not intended to be an exhaustive list of all possible uses of the products, nor is it intended to imply that the uses listed may be suitable for the products:

- Outdoor use, uses involving potential chemical contamination or electrical interference, or conditions or uses not described in this catalog.
- Nuclear energy control systems, combustion systems, railroad systems, aviation systems, medical equipment, amusement machines, vehicles, safety equipment, and installations subject to separate industry or government regulations.
- Systems, machines, and equipment that could present a risk to life or property.

Please know and observe all prohibitions of use applicable to the products.

NEVER USE THE PRODUCTS FOR AN APPLICATION INVOLVING SERIOUS RISK TO LIFE OR PROPERTY WITHOUT ENSURING THAT THE SYSTEM AS A WHOLE HAS BEEN DESIGNED TO ADDRESS THE RISKS, AND THAT THE OMRON PRODUCTS ARE PROPERLY RATED AND INSTALLED FOR THE INTENDED USE WITHIN THE OVERALL EQUIPMENT OR SYSTEM.

PROGRAMMABLE PRODUCTS

OMRON shall not be responsible for the user's programming of a programmable product, or any consequence thereof.

Disclaimers

CHANGE IN SPECIFICATIONS

Product specifications and accessories may be changed at any time based on improvements and other reasons.

It is our practice to change model numbers when published ratings or features are changed, or when significant construction changes are made. However, some specifications of the products may be changed without any notice. When in doubt, special model numbers may be assigned to fix or establish key specifications for your application on your request. Please consult with your OMRON representative at any time to confirm actual specifications of purchased products.

DIMENSIONS AND WEIGHTS

Dimensions and weights are nominal and are not to be used for manufacturing purposes, even when tolerances are shown.

PERFORMANCE DATA

Performance data given in this catalog is provided as a guide for the user in determining suitability and does not constitute a warranty. It may represent the result of OMRON's test conditions, and the users must correlate it to actual application requirements. Actual performance is subject to the OMRON Warranty and Limitations of Liability.

ERRORS AND OMISSIONS

The information in this document has been carefully checked and is believed to be accurate; however, no responsibility is assumed for clerical, typographical, or proofreading errors, or omissions.

2008.11

In the interest of product improvement, specifications are subject to change without notice.

OMRON Corporation
Industrial Automation Company

<http://www.ia.omron.com/>

(c)Copyright OMRON Corporation 2008 All Right Reserved.

Компания «Океан Электроники» предлагает заключение долгосрочных отношений при поставках импортных электронных компонентов на взаимовыгодных условиях!

Наши преимущества:

- Поставка оригинальных импортных электронных компонентов напрямую с производств Америки, Европы и Азии, а так же с крупнейших складов мира;
- Широкая линейка поставок активных и пассивных импортных электронных компонентов (более 30 млн. наименований);
- Поставка сложных, дефицитных, либо снятых с производства позиций;
- Оперативные сроки поставки под заказ (от 5 рабочих дней);
- Экспресс доставка в любую точку России;
- Помощь Конструкторского Отдела и консультации квалифицированных инженеров;
- Техническая поддержка проекта, помощь в подборе аналогов, поставка прототипов;
- Поставка электронных компонентов под контролем ВП;
- Система менеджмента качества сертифицирована по Международному стандарту ISO 9001;
- При необходимости вся продукция военного и аэрокосмического назначения проходит испытания и сертификацию в лаборатории (по согласованию с заказчиком);
- Поставка специализированных компонентов военного и аэрокосмического уровня качества (Xilinx, Altera, Analog Devices, Intersil, Interpoint, Microsemi, Actel, Aeroflex, Peregrine, VPT, Syfer, Eurofarad, Texas Instruments, MS Kennedy, Miteq, Cobham, E2V, MA-COM, Hittite, Mini-Circuits, General Dynamics и др.);

Компания «Океан Электроники» является официальным дистрибьютором и эксклюзивным представителем в России одного из крупнейших производителей разъемов военного и аэрокосмического назначения «JONHON», а так же официальным дистрибьютором и эксклюзивным представителем в России производителя высокотехнологичных и надежных решений для передачи СВЧ сигналов «FORSTAR».



JONHON

«JONHON» (основан в 1970 г.)

Разъемы специального, военного и аэрокосмического назначения:

(Применяются в военной, авиационной, аэрокосмической, морской, железнодорожной, горно- и нефтедобывающей отраслях промышленности)

«FORSTAR» (основан в 1998 г.)

ВЧ соединители, коаксиальные кабели, кабельные сборки и микроволновые компоненты:

(Применяются в телекоммуникациях гражданского и специального назначения, в средствах связи, РЛС, а так же военной, авиационной и аэрокосмической отраслях промышленности).



Телефон: 8 (812) 309-75-97 (многоканальный)

Факс: 8 (812) 320-03-32

Электронная почта: ocean@oceanchips.ru

Web: <http://oceanchips.ru/>

Адрес: 198099, г. Санкт-Петербург, ул. Калинина, д. 2, корп. 4, лит. А