

## Description

The HS300x series is a highly accurate, fully calibrated relative humidity and temperature sensor. The MEMS sensor features a proprietary sensor-level protection, ensuring high reliability and long-term stability.

Integrated calibration and temperature-compensation logic provides fully corrected RH and temperature values via a standard I2C output. No user calibration of the output data is required.

The high accuracy, fast measurement response time, and long-term stability combined with the small package size makes the HS300x series ideal for a wide number of applications ranging from portable devices to products designed for harsh environments.

The HS300x series digital sensor accurately measures relative humidity and temperature levels. The measured data is internally corrected and compensated for accurate operation over a wide range of temperature and humidity levels – user calibration is not required.

## Typical Applications

- Climate control systems
- Home appliances
- Weather stations
- Industrial automation
- Medical equipment
- Automotive cabin climate control

## Features

- RH accuracy:  $\pm 1.5\%$ RH, typical (HS3001, 10 to 90%RH, 25°C)
- 14-bit resolution: 0.01%RH, typical
- Fast RH response time: 6 seconds, typical
- Temperature sensor accuracy:  $\pm 0.2^\circ\text{C}$ , typical (HS3001, HS3002, -10 to +80°C)
- Low current consumption: 24.4 $\mu\text{A}$  average (one RH and temperature measurement per second, 14-bit resolution, 3.3V supply)
- Excellent stability against aging
- Highly robust protection from harsh environmental conditions and mechanical shock
- Very low power consumption

## Physical Characteristics

- Extended supply voltage: 2.3V to 5.5V
- Operating temperature: -40°C to +125°C
- 3.0 × 2.41 × 0.8 mm DFN-style 6-LGA package

## Product Image



## Contents

1. Pin Assignments .....	4
2. Pin Descriptions .....	4
3. Absolute Maximum Ratings .....	5
4. Recommended Operating Conditions .....	5
5. Humidity and Temperature Sensor Performance .....	6
5.1 Humidity Sensor Specification .....	6
5.2 Temperature Sensor Specification .....	7
5.3 Humidity Sensor Accuracy Graphs .....	8
5.4 Temperature Sensor Accuracy Graphs .....	9
6. Sensor Interface .....	10
6.1 I2C Features and Timing .....	10
6.2 Sensor Slave Address .....	10
6.3 I2C Communication .....	11
6.4 Measurement Mode .....	11
6.5 Measurement Requests (MR) .....	11
6.6 Data Fetch (DF) .....	12
6.7 Status Bits .....	12
7. Calculating Humidity and Temperature Output .....	13
8. Application Circuit .....	13
9. Package Drawings and Land Pattern .....	14
10. Soldering Information .....	14
11. Storage and Handling .....	15
12. Quality and Reliability .....	15
13. Ordering Information .....	15
14. Revision History .....	16

## List of Figures

Figure 1. Pin Assignments for 3mm × 2.41mm 6-LGA Package (Top View) .....	4
Figure 2. HS3001 RH Accuracy Tolerance at 25°C .....	8
Figure 3. HS3001 RH Accuracy over Temperature .....	8
Figure 4. HS3002 RH Accuracy Tolerance at 25°C .....	8
Figure 5. HS3002 RH Accuracy over Temperature .....	8
Figure 6. HS3003 RH Accuracy Tolerance at 25°C .....	8
Figure 7. HS3003 RH Accuracy over Temperature .....	8
Figure 8. HS3004 RH Accuracy Tolerance at 25°C .....	9
Figure 9. HS3004 RH Accuracy over Temperature .....	9
Figure 10. HS3001/HS3002 Temperature Sensor Accuracy Tolerance .....	9

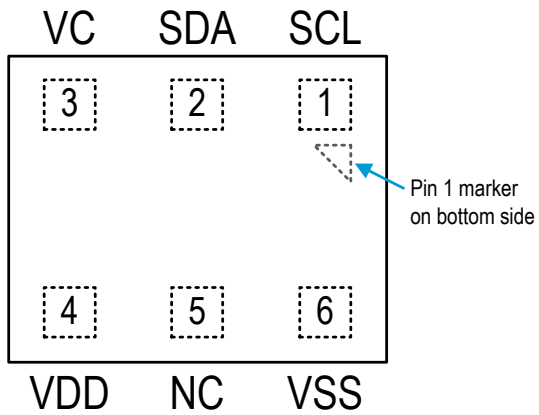
Figure 11. HS3003 Temperature Sensor Accuracy Tolerance .....	9
Figure 12. HS3004 Temperature Sensor Accuracy Tolerance .....	9
Figure 13. Timing Diagram .....	10
Figure 14. START and STOP Condition Waveform.....	11
Figure 15. Measurement Request .....	11
Figure 16. Data Fetch .....	12
Figure 17. Recommended Soldering Profile .....	14

## List of Tables

Table 1. Pin Descriptions.....	4
Table 2. Absolute Maximum Ratings .....	5
Table 3. Operating Conditions .....	5
Table 4. Humidity Sensor Specification, $T_A = +25^{\circ}\text{C}$ , $V_{DD} = 2.3\text{V to } 5.5\text{V}$ .....	6
Table 5. Temperature Sensor Specification, $T_A = +25^{\circ}\text{C}$ , $V_{DD} = 2.3\text{V to } 5.5\text{V}$ .....	7
Table 6. I2C Timing Parameters.....	10
Table 7. Status Bits .....	12

## 1. Pin Assignments

**Figure 1. Pin Assignments for 3mm × 2.41mm 6-LGA Package (Top View)**



## 2. Pin Descriptions

**Table 1. Pin Descriptions**

Pin Number	Name	Type	Description
1	SCL	In/out	Serial clock
2	SDA	In/out	Serial data
3	VC	—	Connect a 0.1µF decoupling capacitor from VC to ground
4	VDD	In	Supply voltage
5	NC	—	Do not connect
6	VSS	In	Ground

[a] “NC” stands for not connected / no connection required / not bonded.

### 3. Absolute Maximum Ratings

The absolute maximum ratings are stress ratings only. Stresses greater than those listed below can cause permanent damage to the device. Functional operation of the HS300x at absolute maximum ratings is not implied. Exposure to absolute maximum rating conditions might affect device reliability.

**Table 2. Absolute Maximum Ratings**

Symbol	Parameter	Conditions	Minimum	Maximum	Units
	Analog Supply Voltage		-0.3	6.0	V
	Storage Temperature Range		-55	150	°C

### 4. Recommended Operating Conditions

Important note: The HS300x series sensors are optimized to perform best in the more common temperature and humidity ranges of 10°C to 50°C and 20% RH to 80% RH, respectively. If operated outside of these conditions for extended periods, especially at high humidity levels, the sensors may exhibit an offset. In most cases, this offset is temporary and will gradually disappear once the sensor is returned to normal temperature and humidity conditions. The amount of the shift and the duration of the offset vary depending on the duration of exposure and the severity of the relative humidity and temperature conditions. The time needed for the offset to disappear can also be decreased by using the procedures described in sections 10 and 11.

**Table 3. Operating Conditions**

Parameter	Condition		Minimum	Typical	Maximum	Units
Operating Supply Voltage			2.3	3.3	5.5	V
Sleep Current	Sleep Mode	-40 to 85°C		0.6	1	µA
		-40 to 125°C		1	3	
Average Current <sup>[a]</sup>	One RH + temperature measurement/second	14-bit resolution		24.4	24.4	µA
Measurement Time	Wake-up			0.10		ms
	Humidity or temperature including the digital compensation	14-bit resolution		16.90		
Operating Temperature Range			-40		125	°C

[a] Typical and maximum average currents are given at 3.3V and 5.5V respectively.

## 5. Humidity and Temperature Sensor Performance

### 5.1 Humidity Sensor Specification

**Table 4. Humidity Sensor Specification,  $T_A = +25^\circ\text{C}$ ,  $V_{DD} = 2.3\text{V}$  to  $5.5\text{V}$**

Parameter	Condition		Minimum	Typical	Maximum	Units
Range			0		100	%RH
Accuracy <sup>[a]</sup>	HS3001	10% to 90%RH		±1.5	±1.8	%RH
	HS3002			±1.8	±2.0	
	HS3003			±2.8	±4.0	
	HS3004			±3.8	±5.0	
Resolution	14 bits			0.01	0.015	%RH
Hysteresis					±1.0	%RH
Non-Linearity from Response Curve	HS3001	10% to 90%RH		±0.15	±0.25	%RH
	HS3002					
	HS3003	20% to 80%RH				
	HS3004					
Long-Term Stability				±0.1	±0.25	%RH/Yr
Response Time Constant <sup>[b]</sup> ( $\tau_H$ )	20% to 80% RH Still Air		4.5	6.0	8.0	sec

[a] Monotonic increases from 10 to 90%RH after sensor has been stabilized at 50%RH.

[b] Initial value to 63% of total variation.

## 5.2 Temperature Sensor Specification

**Table 5. Temperature Sensor Specification,  $T_A = +25^\circ\text{C}$ ,  $V_{DD} = 2.3\text{V}$  to  $5.5\text{V}$**

Parameter	Condition		Minimum	Typical	Maximum	Units
Range			-40		125	$^\circ\text{C}$
Accuracy	HS3001	$-10^\circ\text{C}$ to $80^\circ\text{C}$		$\pm 0.2$	$\pm 0.3$	$^\circ\text{C}$
	HS3002					
	HS3003	$0^\circ\text{C}$ to $70^\circ\text{C}$		$\pm 0.25$	$\pm 0.35$	
	HS3004			$\pm 0.3$	$\pm 0.5$	
Resolution	14 bits		0.01	0.015	0.025	$^\circ\text{C}$
Response Time Constant <sup>[a]</sup> ( $\tau_T$ )				2.0		Sec.
Long-Term Stability					0.04	$^\circ\text{C}/\text{Yr}$
Supply Voltage Dependency <sup>[b]</sup>	$V_{DD} \geq 2.8\text{V}$			0.03	0.1	$^\circ\text{C}/\text{V}$
	$2.3\text{V} < V_{DD} < 2.8\text{V}$			1.25	2.25	$^\circ\text{C}/\text{V}$

[a] Response time depends on system thermal mass and air flow.

[b] Temperature accuracy can be optimized for specified supply voltages upon request.

### 5.3 Humidity Sensor Accuracy Graphs

The typical and maximum relative humidity sensor accuracy tolerances are shown in the following figures.

**Figure 2. HS3001 RH Accuracy Tolerance at 25°C**



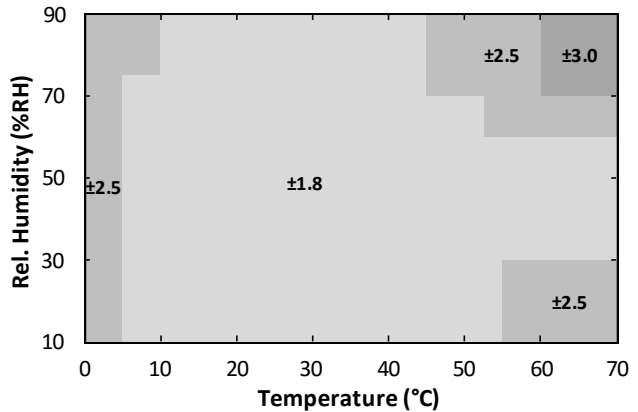
**Figure 3. HS3001 RH Accuracy over Temperature**



**Figure 4. HS3002 RH Accuracy Tolerance at 25°C**



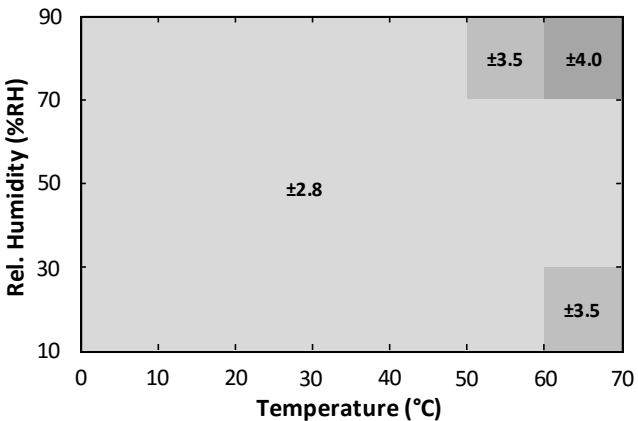
**Figure 5. HS3002 RH Accuracy over Temperature**



**Figure 6. HS3003 RH Accuracy Tolerance at 25°C**

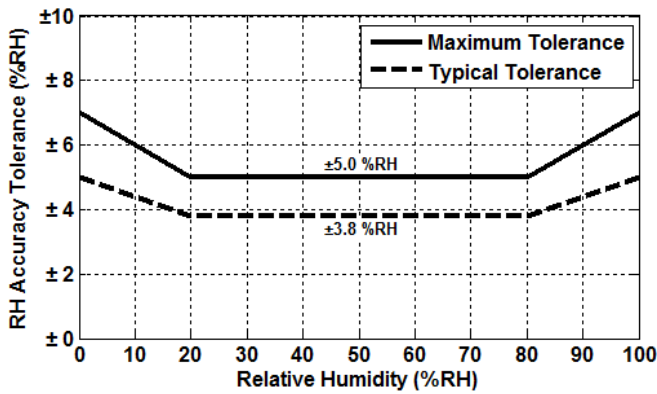


**Figure 7. HS3003 RH Accuracy over Temperature**

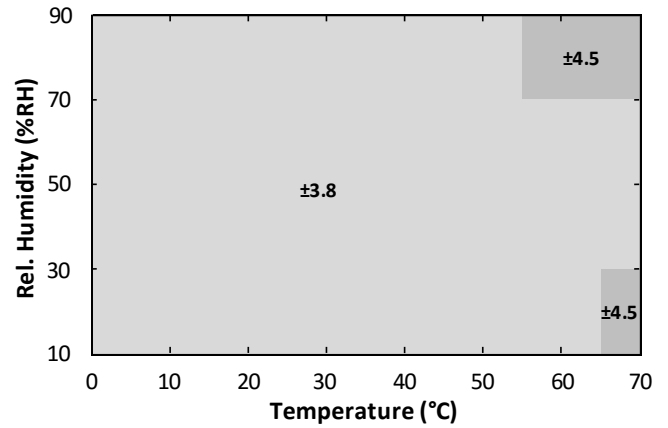




**Figure 8. HS3004 RH Accuracy Tolerance at 25°C**



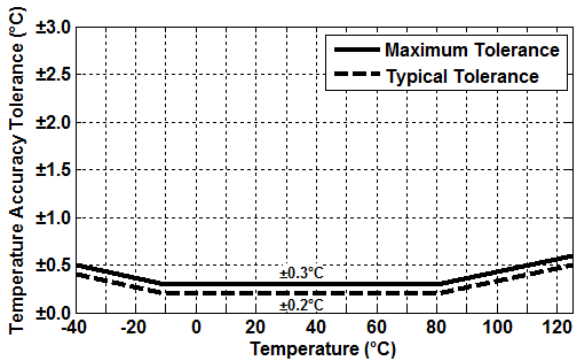
**Figure 9. HS3004 RH Accuracy over Temperature**



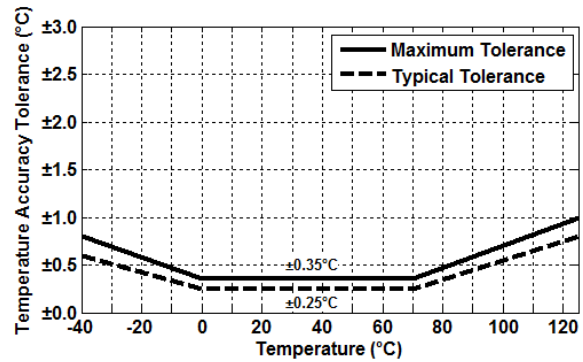
### 5.4 Temperature Sensor Accuracy Graphs

The typical and maximum temperature sensor accuracy tolerances are shown in the following figures.

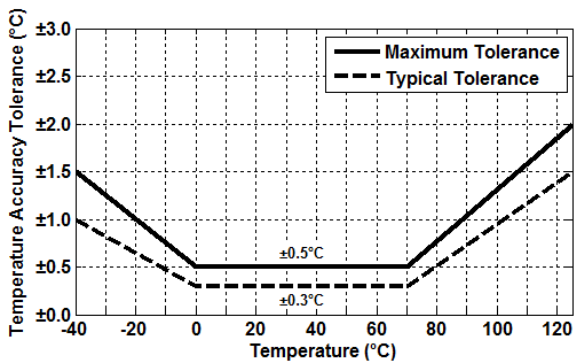
**Figure 10. HS3001/HS3002 Temperature Sensor Accuracy Tolerance**



**Figure 11. HS3003 Temperature Sensor Accuracy Tolerance**



**Figure 12. HS3004 Temperature Sensor Accuracy Tolerance**



## 6. Sensor Interface

The HS300x series sensor uses a digital I2C-compatible communication protocol. To accommodate multiple devices, the protocol uses two bi-directional open-drain lines: the Serial Data Line (SDA) and the Serial Clock Line (SCL). Pull-up resistors to  $V_{DD}$  are required. Several slave devices can share the bus; however only one master device can be present on the line.

### 6.1 I2C Features and Timing

The HS300x series sensor operates as a slave device on the I2C bus with support for 100kHz and 400kHz bit rates. Each transmission is initiated when the master sends a 0 START bit (S), and the transmission is terminated when the master sends a 1 STOP bit (P). These bits are only transmitted while the SCL line is HIGH.

**Figure 13. Timing Diagram**



**Table 6. I2C Timing Parameters**

Parameter	Symbol	Minimum	Typical	Maximum	Units
SCL Clock Frequency <sup>[a]</sup>	$f_{SCL}$	20		400	kHz
START Condition Hold Time Relative to SCL Edge	$t_{HDSTA}$	0.1			$\mu s$
Minimum SCL Clock LOW Width <sup>[b]</sup>	$t_{LOW}$	0.6			$\mu s$
Minimum SCL Clock HIGH Width <sup>[b]</sup>	$t_{HIGH}$	0.6			$\mu s$
START Condition Setup Time Relative to SCL Edge	$t_{SUSTA}$	0.1			$\mu s$
Data Hold Time on SDA Relative to SCL Edge	$t_{HDDAT}$	0		0.5	$\mu s$
Data Setup Time on SDA Relative to SCL Edge	$t_{SUDAT}$	0.1			$\mu s$
STOP Condition Setup Time on SCL	$t_{SUSTO}$	0.1			$\mu s$
Bus Free Time Between STOP Condition and START Condition	$t_{BUS}$	1			$\mu s$

[a] The minimum frequency of 20kHz applies to test only; no minimum under normal operations.

[b] Combined LOW and HIGH widths must equal or exceed the minimum SCL period.

### 6.2 Sensor Slave Address

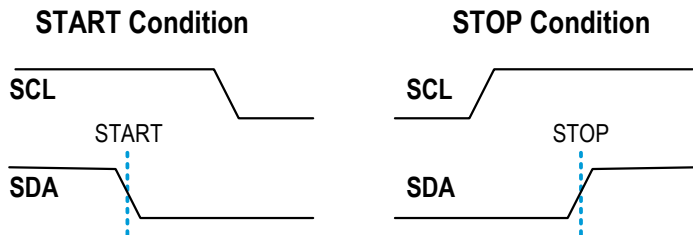
The HS300x series default I2C address is 44<sub>HEX</sub>. The device will respond only to this 7-bit address. See section 6.3 for further information.

### 6.3 I2C Communication

The sensor transmission is initiated when the master sends a 0 START bit (S). The transmission is terminated when the master sends a 1 STOP bit (P). These bits are only transmitted while the SCL line is HIGH (see Figure 14 for waveforms).

Once the START condition has been set, the SCL line is toggled at the prescribed data rate, clocking subsequent data transfers. Data on the SDA line is always sampled on the rising edge of the SCL line and must remain stable while SCL is HIGH to prevent false START or STOP conditions.

**Figure 14. START and STOP Condition Waveform**



After the START bit, the master device sends the 7-bit slave address (see section 6.2) to the HS300x, followed by the read/write bit, which indicates the transfer direction of any subsequent data. This bit is set to 1 to indicate a read from slave to master or set to 0 to indicate a write from master to slave.

All transfers consist of 8 bits and a response bit: 0 for Acknowledge (ACK) or 1 for Not Acknowledge (NACK). After the ACK is received, another data byte can be transferred or the communication can be stopped with a STOP bit.

### 6.4 Measurement Mode

The HS300x is factory-programmed to operate in Sleep Mode. In Sleep Mode, the sensor waits for commands from the master before taking measurements. The digital core only performs conversions when it receives a *Measurement Request* command (MR); otherwise, it is always powered down.

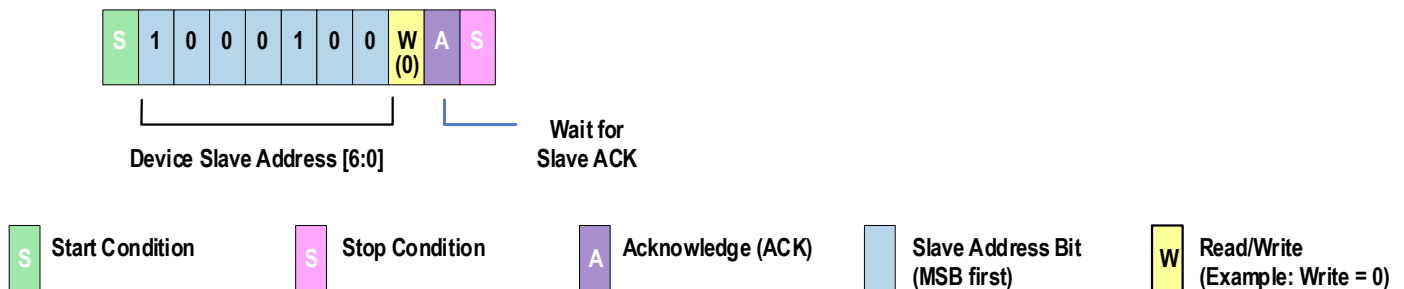
### 6.5 Measurement Requests (MR)

The MR command is required to wake up the HS300x from its Sleep Mode. Initiate the Measurement Request by sending the 7-bit slave address followed by an eighth bit = 0 (WRITE).

A measurement cycle consists of a humidity and temperature conversion followed by the digital signal processor (DSP) correction calculations. At the end of a measurement cycle, the digital output register will be updated before powering down.

The output is always scaled to 14 bits. The order of the bits is big-endian.

**Figure 15. Measurement Request**



### 6.6 Data Fetch (DF)

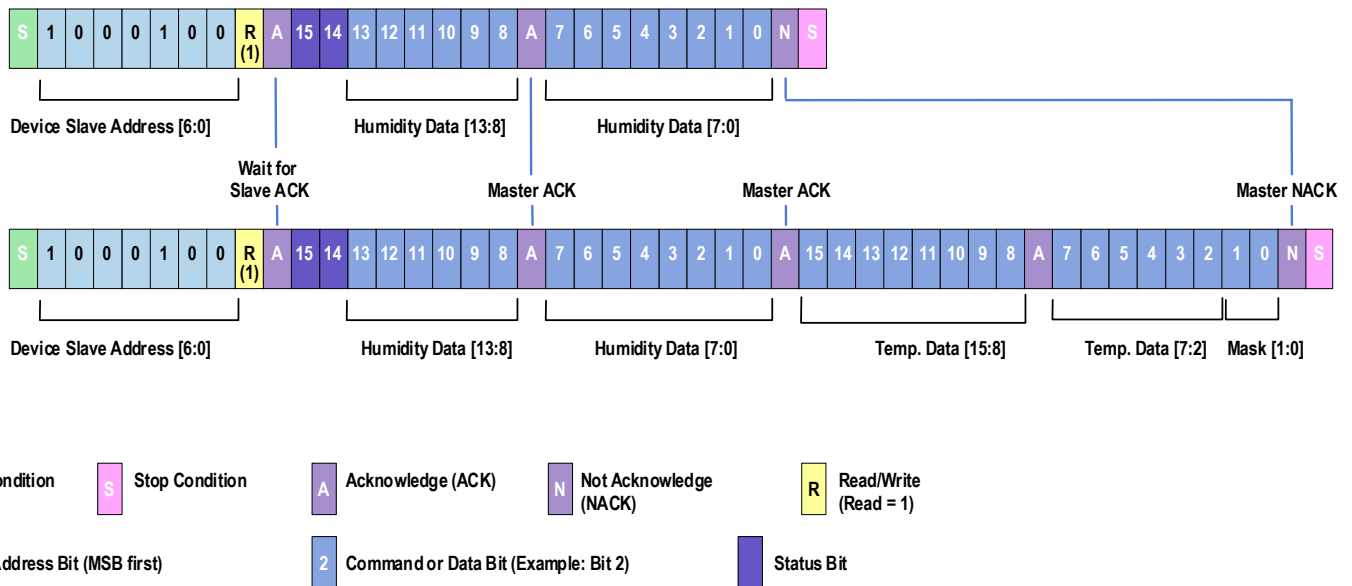
At the end of a measurement cycle, valid data can be fetched. The status bits of the DF results can be used to detect if the data is valid or stale (see section 6.7); otherwise, wait for the measurements to complete before performing the DF.

The DF command starts with the 7-bit slave address followed by an eighth bit = 1 (READ). The HS300x as a slave sends an acknowledge (ACK) indicating success.

The number of data bytes returned by the HS300x is determined by when the master sends the NACK and STOP condition. The full 14 bits of the humidity data are fetched in the first two bytes. The two MSBs of the first byte are the status bits.

The 14 bits of temperature data follow the humidity data. The last two bits (LSBs) of the fourth data byte are undetermined and should be masked off. In the event that the temperature data is not needed, the read can be terminated by sending a NACK after the second byte.

**Figure 16. Data Fetch**



### 6.7 Status Bits

The status bits are used to indicate the current state of the fetched data. The two MSBs of the humidity data byte are the status bits (see the following table).

**Table 7. Status Bits**

Status Bits	Definition
00 <sub>B</sub>	Valid Data: Data that has not been fetched since the last measurement cycle
01 <sub>B</sub>	Stale Data: Data that has already been fetched since the last measurement cycle Note: If a data fetch is performed before or during the first measurement after power-on reset, then the stale status will be returned, but this data is actually invalid since the first measurement has not been completed.

## 7. Calculating Humidity and Temperature Output

The entire output of the HS300x is 4 bytes. The relative humidity (in percent) and the temperature (in degrees Celsius) are calculated with Equation 1 and Equation 2, respectively.

$$\text{Humidity [\%RH]} = \left( \frac{\text{Humidity [13:0]}}{2^{14} - 1} \right) * 100 \quad \text{Equation 1}$$

$$\text{Temperature [}^\circ\text{C]} = \left( \frac{\text{Temperature [15:2]}}{2^{14} - 1} \right) * 165 - 40 \quad \text{Equation 2}$$

## 8. Application Circuit

Figure 17. HS300x Application Circuit (Top View)



## 9. Package Drawings and Land Pattern

The package outline drawings are appended at the end of this document and are accessible from the link below. The package information is the most current data available.

[www.idt.com/document/psc/6-lga-package-outline-drawing-30-x-241-x-08-mm-body-10mm-pitch-lhg6d1](http://www.idt.com/document/psc/6-lga-package-outline-drawing-30-x-241-x-08-mm-body-10mm-pitch-lhg6d1)

## 10. Soldering Information

This section discusses soldering considerations for the HS300x. When a relative humidity sensor is exposed to the high heat associated with the soldering process, the sensor element tends to dry out. To avoid an offset in the relative humidity readings, the sensor element must be rehydrated after the soldering process. Care must also be taken when selecting the temperatures and durations involved in the soldering process to avoid irreversibly damaging the sensor element.

The recommended soldering profile for a lead-free (RoHS-compliant) process is shown below.

**Figure 17. Recommended Soldering Profile**



It is important to ensure this temperature profile is measured at the sensor itself. Measuring the profile at a larger component with a higher thermal mass means the temperature at the small sensor will be higher than expected.

For manual soldering, the contact time must be limited to **5 seconds** with a maximum iron temperature of **350°C**.

In either case, a board wash after soldering is **not** recommended. Therefore, if a solder paste is used, it is strongly recommended that a “**no-clean**” solder paste is used to avoid the need to wash the PCB.

After soldering, the recommended rehydration conditions are either:

- A relative humidity of 75% RH at room temperature for at least 12 hours
- A relative humidity of 40% to 50% RH at room temperature for 3 to 5 days

Otherwise, in the relative humidity readings, there might be an initial offset, which will slowly disappear as the sensor is exposed to ambient conditions.

## 11. Storage and Handling

Recommendation: Once the sensors are removed from their original packaging, store them in metal-in antistatic bags.

Avoid using polyethylene antistatic bags as they may affect sensor accuracy.

The nominal storage conditions are 10 to 50°C and humidity levels within 20% to 60%RH. If stored outside of these conditions for extended periods of time, the sensor readings may exhibit an offset. The sensor can be reconditioned and brought back to its calibration state by applying the following procedure:

1. Bake at a temperature of 100°C with a humidity < 10%RH for 10 to 12 hours.
2. Rehydrate the sensor at a humidity of 75%RH and a temperature between 20 to 30°C for 12 to 14 hours.

## 12. Quality and Reliability

The HS300x series is available as a qualified product for consumer and industrial market applications. All data specified parameters are guaranteed if not stated otherwise.

## 13. Ordering Information

Orderable Part Number	Description and Package	Carrier Type	Temperature
HS3001	Digital Relative Humidity and Temperature Sensor. ±1.5%RH (Typical), 3.0 × 2.41 × 0.8mm, 6-LGA (LHG6D1)	Cut Tape	-40°C to +125°C
HS3002	Digital Relative Humidity and Temperature Sensor. ±1.8%RH (Typical), 3.0 × 2.41 × 0.8mm, 6-LGA (LHG6D1)	Cut Tape	-40°C to +125°C
HS3003	Digital Relative Humidity and Temperature Sensor. ±2.8%RH (Typical), 3.0 × 2.41 × 0.8mm, 6-LGA (LHG6D1)	Cut Tape	-40°C to +125°C
HS3004	Digital Relative Humidity and Temperature Sensor. ±3.8%RH (Typical), 3.0 × 2.41 × 0.8mm, 6-LGA (LHG6D1)	Cut Tape	-40°C to +125°C

## 14. Revision History

Revision Date	Description of Change
August 6, 2018	<ul style="list-style-type: none"> <li>▪ Updated temperature sensor response time in Table 5.</li> </ul>
April 24, 2018	<ul style="list-style-type: none"> <li>▪ Clarified Figure 15 and Figure 16.</li> <li>▪ Update for Equation 2.</li> <li>▪ Edits for section 6.6.</li> <li>▪ Template updates for section 9.</li> </ul>
February 14, 2018	Changed operating voltage and added recommended operating conditions.
November 8, 2017	Initial release.



### Corporate Headquarters

6024 Silver Creek Valley Road  
San Jose, CA 95138  
[www.IDT.com](http://www.IDT.com)

### Sales

1-800-345-7015 or 408-284-8200  
Fax: 408-284-2775  
[www.IDT.com/go/sales](http://www.IDT.com/go/sales)

### Tech Support

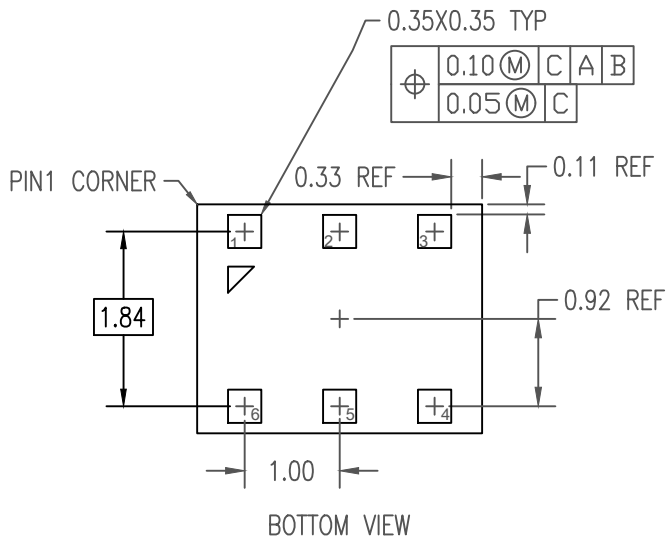
[www.IDT.com/go/support](http://www.IDT.com/go/support)

DISCLAIMER Integrated Device Technology, Inc. (IDT) and its affiliated companies (herein referred to as "IDT") reserve the right to modify the products and/or specifications described herein at any time, without notice, at IDT's sole discretion. Performance specifications and operating parameters of the described products are determined in an independent state and are not guaranteed to perform the same way when installed in customer products. The information contained herein is provided without representation or warranty of any kind, whether express or implied, including, but not limited to, the suitability of IDT's products for any particular purpose, an implied warranty of merchantability, or non-infringement of the intellectual property rights of others. This document is presented only as a guide and does not convey any license under intellectual property rights of IDT or any third parties.

IDT's products are not intended for use in applications involving extreme environmental conditions or in life support systems or similar devices where the failure or malfunction of an IDT product can be reasonably expected to significantly affect the health or safety of users. Anyone using an IDT product in such a manner does so at their own risk, absent an express, written agreement by IDT.

Integrated Device Technology, IDT and the IDT logo are trademarks or registered trademarks of IDT and its subsidiaries in the United States and other countries. Other trade marks used herein are the property of IDT or their respective third party owners. For datasheet type definitions and a glossary of common terms, visit [www.idt.com/go/glossary](http://www.idt.com/go/glossary). All contents of this document are copyright of Integrated Device Technology, Inc. All rights reserved.





NOTES:

1. ALL DIMENSION ARE IN mm. ANGLES IN DEGREES.



### RECOMMENDED LAND PATTERN DIMENSION

#### NOTES:

1. ALL DIMENSION ARE IN mm. ANGLES IN DEGREES.
2. TOP DOWN VIEW. AS VIEWED ON PCB.
3. LAND PATTERN RECOMMENDATION PER IPC-7351B GENERIC REQUIREMENT FOR SURFACE MOUNT DESIGN AND LAND PATTERN.

Package Revision History		
Date Created	Rev No.	Description
June 25, 2018	Rev 01	Revise Lead Length
Sept 25, 2017	Rev 00	Initial Release

Компания «Океан Электроники» предлагает заключение долгосрочных отношений при поставках импортных электронных компонентов на взаимовыгодных условиях!

Наши преимущества:

- Поставка оригинальных импортных электронных компонентов напрямую с производств Америки, Европы и Азии, а так же с крупнейших складов мира;
- Широкая линейка поставок активных и пассивных импортных электронных компонентов (более 30 млн. наименований);
- Поставка сложных, дефицитных, либо снятых с производства позиций;
- Оперативные сроки поставки под заказ (от 5 рабочих дней);
- Экспресс доставка в любую точку России;
- Помощь Конструкторского Отдела и консультации квалифицированных инженеров;
- Техническая поддержка проекта, помощь в подборе аналогов, поставка прототипов;
- Поставка электронных компонентов под контролем ВП;
- Система менеджмента качества сертифицирована по Международному стандарту ISO 9001;
- При необходимости вся продукция военного и аэрокосмического назначения проходит испытания и сертификацию в лаборатории (по согласованию с заказчиком);
- Поставка специализированных компонентов военного и аэрокосмического уровня качества (Xilinx, Altera, Analog Devices, Intersil, Interpoint, Microsemi, Actel, Aeroflex, Peregrine, VPT, Syfer, Eurofarad, Texas Instruments, MS Kennedy, Miteq, Cobham, E2V, MA-COM, Hittite, Mini-Circuits, General Dynamics и др.);

Компания «Океан Электроники» является официальным дистрибьютором и эксклюзивным представителем в России одного из крупнейших производителей разъемов военного и аэрокосмического назначения «**JONHON**», а так же официальным дистрибьютором и эксклюзивным представителем в России производителя высокотехнологичных и надежных решений для передачи СВЧ сигналов «**FORSTAR**».



## JONHON

«**JONHON**» (основан в 1970 г.)

Разъемы специального, военного и аэрокосмического назначения:

(Применяются в военной, авиационной, аэрокосмической, морской, железнодорожной, горно- и нефтедобывающей отраслях промышленности)

«**FORSTAR**» (основан в 1998 г.)

ВЧ соединители, коаксиальные кабели, кабельные сборки и микроволновые компоненты:

(Применяются в телекоммуникациях гражданского и специального назначения, в средствах связи, РЛС, а так же военной, авиационной и аэрокосмической отраслях промышленности).



Телефон: 8 (812) 309-75-97 (многоканальный)

Факс: 8 (812) 320-03-32

Электронная почта: [ocean@oceanchips.ru](mailto:ocean@oceanchips.ru)

Web: <http://oceanchips.ru/>

Адрес: 198099, г. Санкт-Петербург, ул. Калинина, д. 2, корп. 4, лит. А