



Key and Ignition Switches



Key and Ignition Switches

Customization is standard with Honeywell's key and ignition switches. Honeywell's broad range of product options make building the specific key switch for an application simple. Optional features of multiple unique key codes, momentary positions, terminal and integral connector types, UL-ratings, and various circuitry configurations are available to provide design flexibility. To maintain consistent branding, Honeywell also offers over-molded keys with custom logos. These options, coupled with the wide electrical rating and temperature range, come standard on every switch to meet growing customers' needs.

These rugged and reliable switches increase application reliability and facilitate seamless equipment operation and control with their ability to keep dirt and moisture out of the contact chamber, thereby prolonging switch life. The two-, three-, and four position key switch options easily integrate into specific application designs.

Designed to withstand harsh environments with a robust, environmentally sealed design, Honeywell key and ignition switches are found in the toughest applications, from off-road vehicles like ATVs, snowmobiles, and motorcycles to agriculture, construction, industrial, and lawn and garden equipment.

What makes our key switches better?

- Robust design with o-rings, weep holes, and overmolded keys delivers consistent performance in harsh environments
- Multiple position, circuitry, contact, key, and connector options to address unique application requirements
- UL certified listings offered
- Availability of over-molded keys with custom logos and ability to match existing key codes
- Decades of engineering, design, and application experience

***Manufactured for harsh,
rugged environments***



HIGH DURABILITY
MULTIPLE CONFIGURATIONS

Features and Benefits

ENVIRONMENTAL PROTECTION

Honeywell key and ignition switches are designed and tested to **withstand a wide range of environmental conditions and contaminants**: temperature cycling, chemical splashes, pressure wash, vibration, dust, humidity, and salt. O-rings protect the contact chamber from moisture and dust while weep holes in the key cylinder housing facilitate drainage.

IMPROVED DURABILITY

Stainless steel keyhole shroud and keyhole dust shutter add **durability and corrosion resistance to the key tumbler/cylinder assembly**. The key cover (key boot) protects key cylinder from dust and ingress.

Form factor! Easily customized for specific applications

ROBUST CONSTRUCTION

Polypropylene plastic housing (rear) improves durability and supports equipment weight reduction.

WIDE RANGE OF CONFIGURATIONS

Two-, three-, or four-position switches, maintained and momentary (recoil) key positions, and numerous circuitry configurations allow for customization of equipment operation and control. **UL certification options** available, as well. To maintain consistent branding, Honeywell also offers **over molded keys with custom logos**.

MULTIPLE KEY OPTIONS

Double-sided keys allow for **easy key insertion** and switches can be designed to allow for **key removal in various key positions**. Up to **300 unique key codes** are available to provide increased security and compatibility with existing keys.

CONNECTOR CHOICES

Integral connector (Metri-Pack, Sumitomo): Two-, three-, or four-position switches.
Screw terminal: Two- or three-position switches.

FASTER ASSEMBLY

Integral connectors **facilitate quick assembly** and minimize the potential for wiring errors.

Potential Applications



Honeywell key and ignition switches can be used in a variety of transportation and industrial applications ranging from run/start ignition to single-point control for lights and accessories.

- All-terrain vehicles
- Snowmobiles
- Golf carts
- Aerial/scissor/boom lifts
- Telehandlers
- Construction equipment
- Skid loaders
- Forklifts
- Agricultural equipment
- Tractors
- Material handlers
- Marine equipment
- Generators



Key and Ignition Switches

Table 1. Specifications

Characteristic	Integral Connector	Screw Terminal
Connector	Delphi Metri-Pack or Sumitomo	Screw
Electrical rating (res.)	12 Vdc, 20 A; 24 Vdc, 8 A	12 Vdc, 20 A; 24 Vdc, 10 A; 48 Vdc, 4 A
Operating temperature	-40 °C to 85 °C [-40 °F to 185 °F]	-40 °C to 85 °C [-40 °F to 185 °F]
Cycle life at electrical load	25000 cycles	25000 cycles
Position	2 position; 3 position; 4 position	2 position; 3 position
Mounting	panel	panel
Depth behind panel	43,43 mm [1.71 in]	39,88 mm [1.57 in]
Sealing	IP rating pending	IP rating pending
Contacts	brass/tin	copper
Approvals	UL available	UL available
Front housing material	40 % mineral-filled nylon	40 % mineral-filled nylon
Rear housing material	polypropylene	polypropylene
Weight	68 g [0.15 lb]	68 g [0.15 lb]

Key and Ignition Switches

Table 2. Key Switch Order Guide and Specifications

	Catalog Listing ¹	Packaging	Connector	Positions	Functions	Terminals
	84825-01	25 units per box, no screws, w/ nuts	Metri-Pack	2	Off-On	4
	84825-02	100 units per box, no screws, w/ nuts				
	84825-04	140 units per box, no screws, w/ nuts				
	84826-01	25 units per box, no screws, w/ nuts	Metri-Pack	3	Off-On-Start (Recoil)	4
	84826-02	100 units per box, no screws, w/ nuts				
	84826-04	140 units per box, no screws, w/ nuts				
	89165-01	25 units per box, no screws, w/ nuts	Metri-Pack	3	Off-On-Start (Recoil)	6
	89165-02	100 units per box, no screws, w/ nuts				
	50084828-04	140 units per box, no screws, w/ nuts	Metri-Pack	3	Off-On-Start (Recoil)	4
	50084828-05	100 units per bag				
	89477-01	25 units per box, no screws, w/ nuts	Metri-Pack	4	Off-On(1)-On(2)-Start	4
	89477-04	140 units per box, no screws, w/ nuts				
	89680-02	100 units per box, no screws, w/ nuts	Metri-Pack	3	On-Off-On	6
	89697-01	25 units per box, no screws, w/ nuts	Metri-Pack	3	Off-On(1)-On(2)	4
	89697-02	100 units per box, no screws, w/ nuts				
	89951-02	100 units per box, no screws, w/ nuts	Sumitomo	2	Off-On	4-pin
	84828-07	25 units per box, with screws & nuts	Screw	2	Off-On	3
	84828-08	100 units per box, with screws & nuts				
	84828-09	140 units per box, with screws & nuts				
	89850-07	25 units per box, with screws & nuts	Screw	2	Off-On	3
	89850-08	100 units per box, with screws & nuts				
	89947-08	100 units per box, with screws & nuts	Screw	2	Off-On	6

¹ Numbers before the dash indicate the model number; numbers following the dash indicate the packaging option. For more information on packaging options, see Table 3.

² When there are two adjacent closures in the circuitry options, contacts remain closed between positions.

Key and Ignition Switches

Contacts	Electrical Rating	Circuitry ² O = Circuit Open; X = Circuit Closed	Key Re- move- able	Key Style	Key Code	Spring- Return	Dimen- sions																				
brass/tin	12 V, 20 A	 <table border="1"> <tr> <td>A&D</td> <td>Off</td> <td>On</td> </tr> <tr> <td>B&C</td> <td>X</td> <td>O</td> </tr> </table>	A&D	Off	On	B&C	X	O	Off	two-sided	6896	no	Figure 1														
A&D	Off	On																									
B&C	X	O																									
brass/tin	12 V, 20 A	 <table border="1"> <tr> <td>A&D</td> <td>Off</td> <td>On</td> <td>Start</td> </tr> <tr> <td>B&C</td> <td>O</td> <td>O</td> <td>X</td> </tr> <tr> <td></td> <td>O</td> <td>X</td> <td>X</td> </tr> </table>	A&D	Off	On	Start	B&C	O	O	X		O	X	X	Off	two-sided	6896	yes	Figure 2								
A&D	Off	On	Start																								
B&C	O	O	X																								
	O	X	X																								
brass/tin	12 V, 20 A	 <table border="1"> <tr> <td>E&F</td> <td>Off</td> <td>On</td> <td>Start</td> </tr> <tr> <td>A&F</td> <td>X</td> <td>O</td> <td>O</td> </tr> <tr> <td>C&D</td> <td>O</td> <td>X</td> <td>O</td> </tr> <tr> <td>A&B</td> <td>O</td> <td>X</td> <td>X</td> </tr> <tr> <td></td> <td>O</td> <td>O</td> <td>X</td> </tr> </table>	E&F	Off	On	Start	A&F	X	O	O	C&D	O	X	O	A&B	O	X	X		O	O	X	Off	two-sided	6896	yes	Figure 3
E&F	Off	On	Start																								
A&F	X	O	O																								
C&D	O	X	O																								
A&B	O	X	X																								
	O	O	X																								
brass/tin	12 V, 20 A	 <table border="1"> <tr> <td>A&D</td> <td>Off</td> <td>On</td> <td>Start</td> </tr> <tr> <td>B&C</td> <td>O</td> <td>O</td> <td>X</td> </tr> <tr> <td></td> <td>O</td> <td>X</td> <td>X</td> </tr> </table>	A&D	Off	On	Start	B&C	O	O	X		O	X	X	Off	two-sided	8001	yes	Figure 2								
A&D	Off	On	Start																								
B&C	O	O	X																								
	O	X	X																								
brass/tin	12 V, 20 A	 <table border="1"> <tr> <td>A&B</td> <td>Off</td> <td>On(1)</td> <td>On(2)</td> <td>Start</td> </tr> <tr> <td>A&B&D</td> <td>O</td> <td>X</td> <td>X</td> <td>X</td> </tr> <tr> <td>A&B&C&D</td> <td>O</td> <td>O</td> <td>X</td> <td>X</td> </tr> <tr> <td></td> <td>O</td> <td>O</td> <td>O</td> <td>X</td> </tr> </table>	A&B	Off	On(1)	On(2)	Start	A&B&D	O	X	X	X	A&B&C&D	O	O	X	X		O	O	O	X	Off	two-sided	6896	yes	Figure 4
A&B	Off	On(1)	On(2)	Start																							
A&B&D	O	X	X	X																							
A&B&C&D	O	O	X	X																							
	O	O	O	X																							
brass/tin	12 V, 20 A	 <table border="1"> <tr> <td>E&F</td> <td>On</td> <td>Off</td> <td>On</td> </tr> <tr> <td>A&F</td> <td>X</td> <td>O</td> <td>O</td> </tr> <tr> <td>C&D</td> <td>O</td> <td>X</td> <td>O</td> </tr> <tr> <td>A&B</td> <td>O</td> <td>X</td> <td>X</td> </tr> <tr> <td></td> <td>O</td> <td>O</td> <td>X</td> </tr> </table>	E&F	On	Off	On	A&F	X	O	O	C&D	O	X	O	A&B	O	X	X		O	O	X	Off	two-sided	6896	no	Figure 5
E&F	On	Off	On																								
A&F	X	O	O																								
C&D	O	X	O																								
A&B	O	X	X																								
	O	O	X																								
brass/tin	12 V, 20 A	 <table border="1"> <tr> <td>B&C</td> <td>Off</td> <td>On(1)</td> <td>On(2)</td> </tr> <tr> <td>A&D</td> <td>O</td> <td>X</td> <td>X</td> </tr> <tr> <td></td> <td>O</td> <td>O</td> <td>X</td> </tr> </table>	B&C	Off	On(1)	On(2)	A&D	O	X	X		O	O	X	Off, On(1)	two-sided	6896	no	Figure 6								
B&C	Off	On(1)	On(2)																								
A&D	O	X	X																								
	O	O	X																								
brass/tin	12 V, 20 A	 <table border="1"> <tr> <td>B&C</td> <td>Off</td> <td>On</td> </tr> <tr> <td>A&D</td> <td>X</td> <td>O</td> </tr> <tr> <td></td> <td>O</td> <td>X</td> </tr> </table>	B&C	Off	On	A&D	X	O		O	X	Off	two-sided	1000	no	Figure 7											
B&C	Off	On																									
A&D	X	O																									
	O	X																									
copper	12 Vdc, 20 A 24 Vdc, 10 A 48 Vdc, 4 A	 <table border="1"> <tr> <td>B&C</td> <td>Off</td> <td>On</td> </tr> <tr> <td>A&D</td> <td>X</td> <td>O</td> </tr> <tr> <td></td> <td>O</td> <td>X</td> </tr> </table>	B&C	Off	On	A&D	X	O		O	X	Off	two-sided	6896	no	Figure 8											
B&C	Off	On																									
A&D	X	O																									
	O	X																									
copper	12 Vdc, 20 A 24 Vdc, 10 A 48 Vdc, 4 A	 <table border="1"> <tr> <td>B&B1</td> <td>Off</td> <td>On</td> </tr> <tr> <td>B&3</td> <td>X</td> <td>X</td> </tr> <tr> <td></td> <td>O</td> <td>X</td> </tr> </table>	B&B1	Off	On	B&3	X	X		O	X	Off	one-sided	3000	no	Figure 8											
B&B1	Off	On																									
B&3	X	X																									
	O	X																									
copper	12 Vdc, 20 A 24 Vdc, 10 A 48 Vdc, 4 A	 <table border="1"> <tr> <td>B&3</td> <td>Off</td> <td>On</td> </tr> <tr> <td>B1&4</td> <td>O</td> <td>X</td> </tr> <tr> <td></td> <td>O</td> <td>X</td> </tr> </table>	B&3	Off	On	B1&4	O	X		O	X	Off	two-sided	6896	no	Figure 9											
B&3	Off	On																									
B1&4	O	X																									
	O	X																									

Key and Ignition Switches

Table 2. Key Switch Order Guide and Specifications, continued

	Catalog Listing ¹	Packaging	Connector	Positions	Functions	Terminals
	84829-02	100 units per box, no screws, w/ nuts	Screw	3	Off-On-Start (Recoil)	3
	84829-07	25 units per box, with screws & nuts				
	84829-08	100 units per box, with screws & nuts				
	84829-09	140 units per box, with screws & nuts				
	84830-02	100 units per box, no screws, w/ nuts	Screw	3	On(1)-Off-On(2)	6
	84830-07	25 units per box, with screws & nuts				
	84830-08	100 units per box, with screws & nuts				
	84830-09	140 units per box, with screws & nuts				
	89476-08	100 units per box, with screws & nuts	Screw	3	On(1)-Off-On(2)	6
	89476-09	140 units per box, with screws & nuts				
	89997-07	25 units per box, with screws & nuts	Screw	3	On(1)-Off-On(2)	6
	89997-09	140 units per box, with screws & nuts				
	90173-09	140 units per box, with screws & nuts	Screw	3	On(1)-Off-On(2)	6
	90220-08	100 units per box, with screws & nuts	Screw	3	On(1)-Off-On(2)	6

¹ Numbers before the dash indicate the model number; numbers following the dash indicate the packaging option. For more information on packaging options, see Table 3.

² When there are two adjacent closures in the circuitry options, contacts remain closed between positions.

Table 3. Packaging Codes

Code	Quantity/Packaging ³	Fastenings
01	25 units per box	25 mounting nuts in bag, placed in top layer of carton (no screws)
02	100 units per box	100 mounting nuts in bag, placed in top layer of carton (no screws)
04	140 units per box	140 mounting nuts in bag, placed in top layer of carton (no screws)
07	25 units per box	25 mounting nuts in a bag and the required amount of screws in a bag, placed in top layer of carton
08	100 units per box	100 mounting nuts in a bag and the required amount of screws in a bag, placed in top layer of carton
09	140 units per box	140 mounting nuts in a bag and the required amount of screws in a bag, placed in top layer of carton
10	50 units per box	50 switches individually bagged with mounting nuts and required amount of screws

³ Key switches are bulk packed in cardboard layers with dividers. Products are not individually boxed.

Key and Ignition Switches

Contacts	Electrical Rating	Circuitry ² O = Circuit Open; X = Circuit Closed	Key Re- move- able	Key Style	Key Code	Spring- Return	Dimen- sions															
copper	12 Vdc, 20 A 24 Vdc, 10 A 48 Vdc, 4 A	 <table border="1" style="display: inline-table; vertical-align: middle;"> <tr> <td>Off</td> <td>On</td> <td>Start</td> </tr> <tr> <td>B&B1</td> <td>O</td> <td>X</td> </tr> <tr> <td>B&B3</td> <td>O</td> <td>X</td> </tr> </table>	Off	On	Start	B&B1	O	X	B&B3	O	X	Off	two-sided	6896	yes	Figure 10						
Off	On	Start																				
B&B1	O	X																				
B&B3	O	X																				
copper	12 Vdc, 20 A 24 Vdc, 10 A 48 Vdc, 4 A	 <table border="1" style="display: inline-table; vertical-align: middle;"> <tr> <td>On(1)</td> <td>Off</td> <td>On(2)</td> </tr> <tr> <td>B&B1</td> <td>X</td> <td>O</td> </tr> <tr> <td>B&B2</td> <td>X</td> <td>O</td> </tr> <tr> <td>B&B3</td> <td>O</td> <td>X</td> </tr> <tr> <td>B1&4</td> <td>O</td> <td>X</td> </tr> </table>	On(1)	Off	On(2)	B&B1	X	O	B&B2	X	O	B&B3	O	X	B1&4	O	X	Off	two-sided	6896	no	Figure 11
On(1)	Off	On(2)																				
B&B1	X	O																				
B&B2	X	O																				
B&B3	O	X																				
B1&4	O	X																				
copper	12 Vdc, 20 A 24 Vdc, 10 A 48 Vdc, 4 A	 <table border="1" style="display: inline-table; vertical-align: middle;"> <tr> <td>On(1)</td> <td>Off</td> <td>On(2)</td> </tr> <tr> <td>B&B1</td> <td>X</td> <td>O</td> </tr> <tr> <td>B1&2</td> <td>X</td> <td>O</td> </tr> <tr> <td>B&B3</td> <td>O</td> <td>X</td> </tr> <tr> <td>B1&4</td> <td>O</td> <td>X</td> </tr> </table>	On(1)	Off	On(2)	B&B1	X	O	B1&2	X	O	B&B3	O	X	B1&4	O	X	Off	one-sided	9901	no	Figure 11
On(1)	Off	On(2)																				
B&B1	X	O																				
B1&2	X	O																				
B&B3	O	X																				
B1&4	O	X																				
copper	12 Vdc, 20 A 24 Vdc, 10 A 48 Vdc, 4 A	 <table border="1" style="display: inline-table; vertical-align: middle;"> <tr> <td>On(1)</td> <td>Off</td> <td>On(2)</td> </tr> <tr> <td>B&B1</td> <td>X</td> <td>O</td> </tr> <tr> <td>B1&2</td> <td>X</td> <td>O</td> </tr> <tr> <td>B&B3</td> <td>O</td> <td>X</td> </tr> <tr> <td>B1&4</td> <td>O</td> <td>X</td> </tr> </table>	On(1)	Off	On(2)	B&B1	X	O	B1&2	X	O	B&B3	O	X	B1&4	O	X	All posi- tions	one-sided (Ronis 455 key- cut)	3000	no	Figure 11
On(1)	Off	On(2)																				
B&B1	X	O																				
B1&2	X	O																				
B&B3	O	X																				
B1&4	O	X																				
copper	12 Vdc, 20 A 24 Vdc, 10 A 48 Vdc, 4 A	 <table border="1" style="display: inline-table; vertical-align: middle;"> <tr> <td>On(1)</td> <td>Off</td> <td>On(2)</td> </tr> <tr> <td>B&B1</td> <td>X</td> <td>O</td> </tr> <tr> <td>B1&2</td> <td>X</td> <td>O</td> </tr> <tr> <td>B&B3</td> <td>O</td> <td>X</td> </tr> <tr> <td>B1&4</td> <td>O</td> <td>X</td> </tr> </table>	On(1)	Off	On(2)	B&B1	X	O	B1&2	X	O	B&B3	O	X	B1&4	O	X	Off	one-sided (Ronis 455 key- cut)	3000	no	Figure 11
On(1)	Off	On(2)																				
B&B1	X	O																				
B1&2	X	O																				
B&B3	O	X																				
B1&4	O	X																				
copper	12 Vdc, 20 A 24 Vdc, 10 A 48 Vdc, 4 A	 <table border="1" style="display: inline-table; vertical-align: middle;"> <tr> <td>On(1)</td> <td>Off</td> <td>On(2)</td> </tr> <tr> <td>B&B1</td> <td>X</td> <td>O</td> </tr> <tr> <td>B1&2</td> <td>X</td> <td>O</td> </tr> <tr> <td>B&B3</td> <td>O</td> <td>X</td> </tr> <tr> <td>B1&4</td> <td>O</td> <td>X</td> </tr> </table>	On(1)	Off	On(2)	B&B1	X	O	B1&2	X	O	B&B3	O	X	B1&4	O	X	All posi- tions	two-sided	6896	no	Figure 11
On(1)	Off	On(2)																				
B&B1	X	O																				
B1&2	X	O																				
B&B3	O	X																				
B1&4	O	X																				

Key and Ignition Switches

DIMENSIONAL DRAWINGS

Figure 1. Model 84825 Key Switch Dimensions



Figure 2. Models 84826 and 50084828 Key Switch Dimensions



Figure 3. Model 89165 Key Switch Dimensions



Key and Ignition Switches

Figure 4. Model 89477 Key Switch Dimensions



Figure 5. Model 89680 Key Switch Dimensions

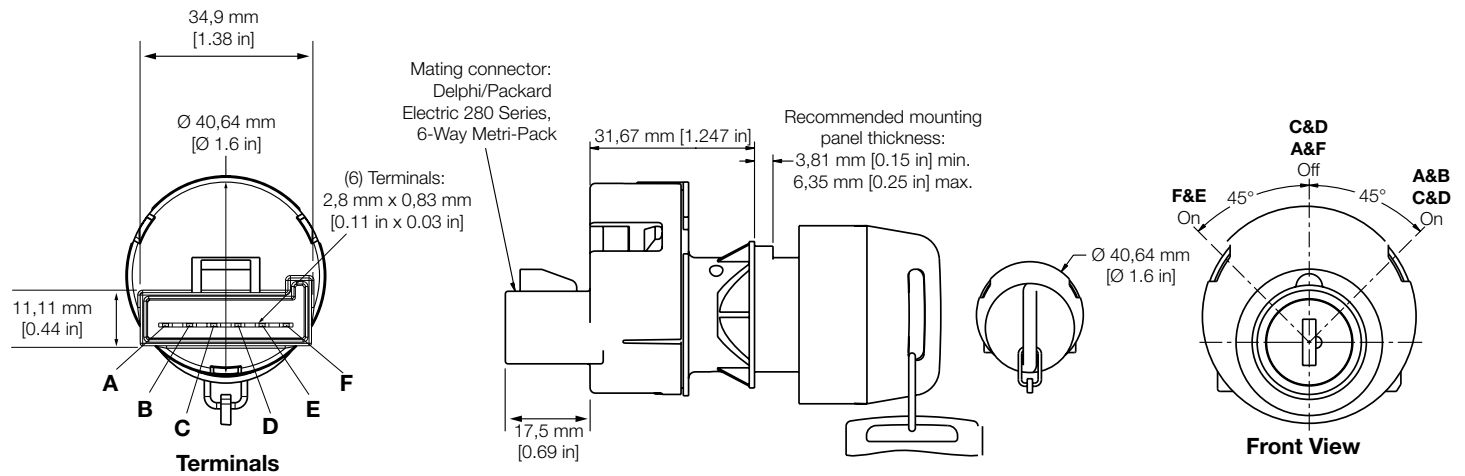

Figure 6. Model 89697 Key Switch Dimensions



Key and Ignition Switches

Figure 7. Model 89951 Key Switch Dimensions



Figure 8. Models 84828 and 89850 Key Switch Dimensions



Figure 9. Model 89947 Key Switch Dimensions

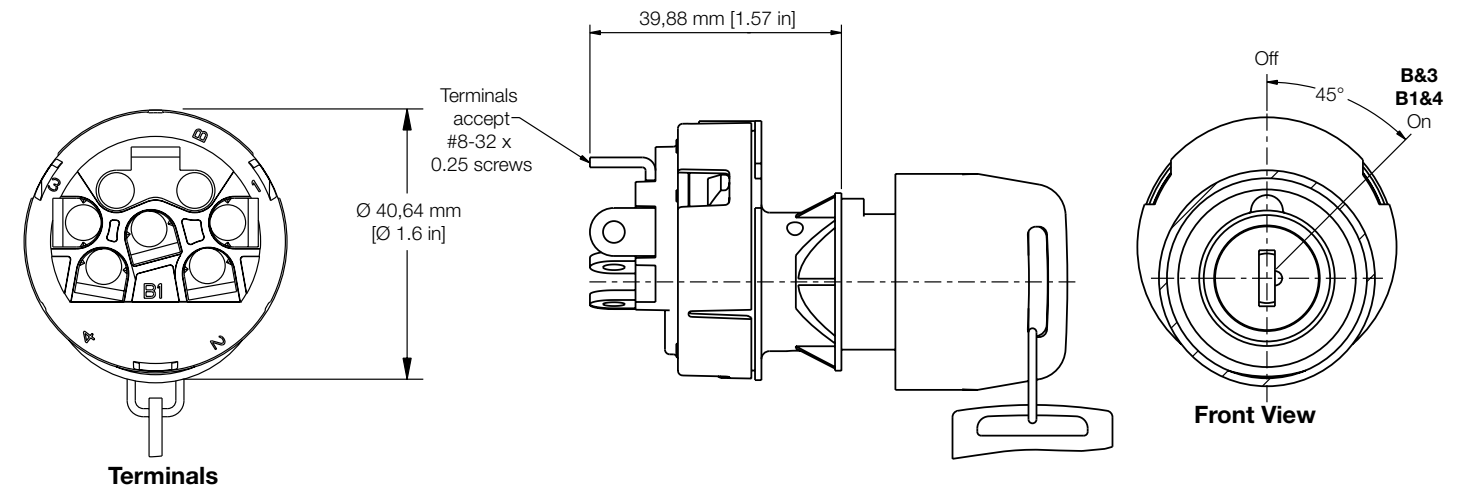

Key and Ignition Switches

Figure 10. Model 84829 Key Switch Dimensions



Figure 11. Models 84830, 89476, 89997, 90173, 90220 Key Switch Dimensions



Figure 12. Mounting Hole Cutout Dimensions



Recommended Mounting Hole
 Recommended mounting panel thickness:
 3.81 mm [0.15 in] min.
 6.35 mm [0.25 in] max.

Figure 13. Mounting Nut Dimensions



Mounting Nut (Part number 81942)
 Torque to 0.576 Kg-m [50 in-lb] max.

Figure 14. Screw Dimensions

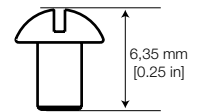

Philips Screw (Part number 3630)
#8-32 x 0.25 screw
 Torque to 10 in-lb ±1 in-lb max.

Key and Ignition Switches

ADDITIONAL INFORMATION

The following associated literature is available on the Honeywell web site at sensing.honeywell.com:

- Product installation instructions
- Product range guide
- Product line guide
- Product application-specific information
 - Application note: Sensors and switches in front loaders
 - Application note: Sensors and switches in mobile cranes

This datasheet supports the following key and ignition switches:

84825-01	89680-02	84829-08
84825-02	89697-01	84829-09
84825-04	89697-02	84830-02
84826-01	89951-02	84830-07
84826-02	84828-07	84830-08
84826-04	84828-08	84830-09
89165-01	84828-09	89476-08
89165-02	89850-07	89476-09
50084828-04	89850-08	89997-07
50084828-05	89947-08	89997-09
89477-01	84829-02	90173-09
89477-04	84829-07	90220-08

WARNING

PERSONAL INJURY

DO NOT USE these products as safety or emergency stop devices or in any other application where failure of the product could result in personal injury.

Failure to comply with these instructions could result in death or serious injury.

WARNING

MISUSE OF DOCUMENTATION

- The information presented in this product sheet is for reference only. Do not use this document as a product installation guide.
- Complete installation, operation, and maintenance information is provided in the instructions supplied with each product.

Failure to comply with these instructions could result in death or serious injury.

WARRANTY/REMEDY

Honeywell warrants goods of its manufacture as being free of defective materials and faulty workmanship. Honeywell's standard product warranty applies unless agreed to otherwise by Honeywell in writing; please refer to your order acknowledgement or consult your local sales office for specific warranty details. If warranted goods are returned to Honeywell during the period of coverage, Honeywell will repair or replace, at its option, without charge those items it finds defective. **The foregoing is buyer's sole remedy and is in lieu of all other warranties, expressed or implied, including those of merchantability and fitness for a particular purpose. In no event shall Honeywell be liable for consequential, special, or indirect damages.**

While we provide application assistance personally, through our literature and the Honeywell website, it is up to the customer to determine the suitability of the product in the application.

Specifications may change without notice. The information we supply is believed to be accurate and reliable as of this printing. However, we assume no responsibility for its use.

Find out more

Honeywell serves its customers through a worldwide network of sales offices, representatives and distributors. For application assistance, current specifications, pricing or name of the nearest Authorized Distributor, contact your local sales office.

To learn more about Honeywell's sensing and control products, call **+1-815-235-6847** or **1-800-537-6945**, visit **sensing.honeywell.com**, or e-mail inquiries to **info.sc@honeywell.com**

Sensing and Control
Honeywell
1985 Douglas Drive North
Golden Valley, MN 55422
honeywell.com

The Honeywell logo is displayed in a bold, red, sans-serif font.

006184-1-EN IL50 GLO
January 2015
Copyright © 2015 Honeywell International Inc. All rights reserved.

Компания «Океан Электроники» предлагает заключение долгосрочных отношений при поставках импортных электронных компонентов на взаимовыгодных условиях!

Наши преимущества:

- Поставка оригинальных импортных электронных компонентов напрямую с производств Америки, Европы и Азии, а так же с крупнейших складов мира;
- Широкая линейка поставок активных и пассивных импортных электронных компонентов (более 30 млн. наименований);
- Поставка сложных, дефицитных, либо снятых с производства позиций;
- Оперативные сроки поставки под заказ (от 5 рабочих дней);
- Экспресс доставка в любую точку России;
- Помощь Конструкторского Отдела и консультации квалифицированных инженеров;
- Техническая поддержка проекта, помощь в подборе аналогов, поставка прототипов;
- Поставка электронных компонентов под контролем ВП;
- Система менеджмента качества сертифицирована по Международному стандарту ISO 9001;
- При необходимости вся продукция военного и аэрокосмического назначения проходит испытания и сертификацию в лаборатории (по согласованию с заказчиком);
- Поставка специализированных компонентов военного и аэрокосмического уровня качества (Xilinx, Altera, Analog Devices, Intersil, Interpoint, Microsemi, Actel, Aeroflex, Peregrine, VPT, Syfer, Eurofarad, Texas Instruments, MS Kennedy, Miteq, Cobham, E2V, MA-COM, Hittite, Mini-Circuits, General Dynamics и др.);

Компания «Океан Электроники» является официальным дистрибьютором и эксклюзивным представителем в России одного из крупнейших производителей разъемов военного и аэрокосмического назначения «JONHON», а так же официальным дистрибьютором и эксклюзивным представителем в России производителя высокотехнологичных и надежных решений для передачи СВЧ сигналов «FORSTAR».



JONHON

«JONHON» (основан в 1970 г.)

Разъемы специального, военного и аэрокосмического назначения:

(Применяются в военной, авиационной, аэрокосмической, морской, железнодорожной, горно- и нефтедобывающей отраслях промышленности)

«FORSTAR» (основан в 1998 г.)

ВЧ соединители, коаксиальные кабели, кабельные сборки и микроволновые компоненты:

(Применяются в телекоммуникациях гражданского и специального назначения, в средствах связи, РЛС, а так же военной, авиационной и аэрокосмической отраслях промышленности).



Телефон: 8 (812) 309-75-97 (многоканальный)

Факс: 8 (812) 320-03-32

Электронная почта: ocean@oceanchips.ru

Web: <http://oceanchips.ru/>

Адрес: 198099, г. Санкт-Петербург, ул. Калинина, д. 2, корп. 4, лит. А