

## Type CPF Series

### Key Features

Thin film precision resistors with TC's to 15ppm and tolerances to 0.05%.

Wide range of case sizes from 0201 to 2512

Suitable for all applications where close accuracy and stability are essential

Terminal finish – electroplated 100% matte Sn

### Applications

Communications

Industrial Controls

Instrumentation

Medical



The CPF series is a high stability precision chip resistor range offering various power dissipations relating to a wide range of chip sizes. The CPF series offers TCR's down to 15ppm/°C and resistance tolerances to 0.1%. Standard values are within the IEC 63 E96 and E24 value grids. The CPF has accurate and uniform physical dimensions to facilitate placement

### Electrical Characteristics

Chip Size	0201				
Rated Power @70°C	0.03125W				
Resistance Range Ω	Min.	49R9	49R9	49R9	49R9
	Max	4K99	33K	4K99	33K
Tolerance	0.5			1	
Code Letter	D			F	
Selection series	E24 & E96				
Temp. Coefficient (ppm/°C)	25	50	25	50	
Code Letter	E	C	E	C	
Operating Voltage (Max)	15V				
Max. Overload Voltage	30V				
Operating Temp. Range	-55 ~ +155°C				
Insulation Resistance dry min.	>1000MΩ				
Stability	0.5%				

Chip Size	0402																					
Rated Power @70°C	0.063W																					
Resistance Range Ω	Min.	49R9			49R9			10R			49R9			4R7			49R9			4R7		
	Max	12K			69K8			255K			69K8			511K			69K8			511K		
Tolerance (%)	0.05			0.1			0.5			1												
Code Letter	A			B			D			F												
Selection series	E24 & E96																					
T.C.R. (ppm/°C)	15	25	50	15	25	50	15	25	50	15	25	50										
Code Letter	D	E	C	D	E	C	D	E	C	D	E	C										
Max Operating Volt.	25V																					
Max. Overload Volt.	50V																					
Op. Temp. Range	-55 ~ +155°C																					
Insulation Resistance	>1000MΩ																					
Stability	0.5%																					

Chip Size	0603																				
Rated Power @70°C	0.063W																				
Resistance Range Ω	Min.	4R7			4R7			4R7			1R0			4R7			1R0				
	Max	332K			511K			1M0			511K			1M0			511K			1M0	
Tolerance (%)	0.05			0.1			0.5			1											
Code Letter	A			B			D			F											
Selection series	E24 & E96																				
T.C.R. (ppm/°C)	15	25	50	15	25	50	15	25	50	15	25	50									
Code Letter	D	E	C	D	E	C	D	E	C	D	E	C									
Max Operating Volt.	50V																				
Max. Overload Volt.	100V																				
Op. Temp. Range	-55 ~ +155°C																				
Insulation Resistance	>1000MΩ																				
Stability	0.5%																				

Chip Size	0805																					
Rated Power @70°C	0.1W																					
Resistance Range Ω	Min.	4R7			4R7			4R7			4R7			1R0			4R7			1R0		
	Max	1M0			1M0			2M0			1M0			2M0			1M0			2M0		
Tolerance (%)	0.05			0.1			0.5			1												
Code Letter	A			B			D			F												
Selection series	E24 & E96																					
T.C.R. (ppm/°C)	15	25	50	15	25	50	15	25	50	15	25	50										
Code Letter	D	E	C	D	E	C	D	E	C	D	E	C										
Max Operating Volt.	100V																					
Max. Overload Volt.	200V																					
Op. Temp. Range	-55 ~ +155°C																					
Insulation Resistance	>1000MΩ																					
Stability	0.5%																					

Chip Size	1206												
Rated Power @70°C	0.125W												
Resistance Range Ω	Min.	4R7			4R7			4R7			1R0		
	Max	1M0			1M0			2M49			1M0		
Tolerance (%)	0.05			0.1			0.5			1			
Code Letter	A			B			D			F			
Selection series	E24 & E96												
T.C.R. (ppm/°C)	15	25	50	15	25	50	15	25	50	15	25	50	
Code Letter	D	E	C	D	E	C	D	E	C	D	E	C	
Max Operating Volt.	150V												
Max. Overload Volt.	300V												
Op. Temp. Range	-55 ~ +155°C												
Insulation Resistance	>1000MΩ												
Stability	0.5%												

Chip Size	1210												
Rated Power @70°C	0.25W												
Resistance Range Ω	Min.	4R7			4R7			4R7			1R0		
	Max	1M0			1M0			2M49			1M0		
Tolerance (%)	0.05			0.1			0.5			1			
Code Letter	A			B			D			F			
Selection series	E24 & E96												
T.C.R. (ppm/°C)	15	25	50	15	25	50	15	25	50	15	25	50	
Code Letter	D	E	C	D	E	C	D	E	C	D	E	C	
Max Operating Volt.	150V												
Max. Overload Volt.	300V												
Op. Temp. Range	-55 ~ +155°C												
Insulation Resistance	>1000MΩ												
Stability	0.5%												

Chip Size	2010												
Rated Power @70°C	0.25W												
Resistance Range Ω	Min.	4R7			4R7			4R7			1R0		
	Max	1M0			1M0			3M0			1M0		
Tolerance (%)	0.05			0.1			0.5			1			
Code Letter	A			B			D			F			
Selection series	E24 & E96												
T.C.R. (ppm/°C)	15	25	50	15	25	50	15	25	50	15	25	50	
Code Letter	D	E	C	D	E	C	D	E	C	D	E	C	
Max Operating Volt.	150V												
Max. Overload Volt.	300V												
Op. Temp. Range	-55 ~ +155°C												
Insulation Resistance	>1000MΩ												
Stability	0.5%												

Chip Size	2512															
Rated Power @70°C	0.5W															
Resistance Range Ω	Min.	4R7			4R7			1R0			4R7			1R0		
	Max	1M0			1M0			3M0			1M0			3M0		
Tolerance (%)	0.05			0.1			0.5			1						
Code Letter	A			B			D			F						
Selection series	E24 & E96															
T.C.R. (ppm/°C)	15	25	50	15	25	50	15	25	50	15	25	50				
Code Letter	D	E	C	D	E	C	D	E	C	D	E	C				
Max Operating Volt.	150V															
Max. Overload Volt.	300V															
Op. Temp. Range	-55 ~ +155°C															
Insulation Resistance	>1000MΩ															
Stability	0.5%															

Environmental Characteristics

Item	Requirement		Test Method
	Tol. ≤0.05%	TOL. >0.05%	
Temperature Coefficient of Resistance (TCR)	As per TCRs specified in Electrical Characteristics tables		MIL-STD-202 Method 304 +25/-55/+25/+125/+25°C
Short Time Overload	ΔR±0.05%	ΔR±0.2%	JIS-C-5201-1 5.5 RCWV*2.5 or Max. overload voltage whichever is lower for 5 seconds
Insulation Resistance	>1000 MΩ		MIL-STD-202 Method 302 Apply 100VDC for 1 minute
Endurance	ΔR±0.05%	ΔR±0.2%	MIL-STD-202 Method 108A 70±2°C, RCWV for 1000 hrs with 1.5 hrs "ON" and 0.5 hrs "OFF"
	>7kΩ ΔR±0.5%		
Damp Heat with Load	ΔR±0.05%	ΔR±0.3%	MIL-STD-202 Method 103B 40±2°C, 90~95% R.H. RCWV for 1000 hrs with 1.5 hrs "ON" and 0.5 hrs "OFF"
Bending Strength	ΔR±0.05%	ΔR±0.2%	JIS-C-5201-1 6.1.4 Bending amplitude 3 mm for 10 seconds
Solderability	95% min. coverage		MIL-STD-202 Method 208H 245±5°C for 3 seconds
Resistance to Soldering Heat	ΔR±0.05%	ΔR±0.2%	MIL-STD-202 Method 210E 260±5°C for 10 seconds
Dielectric Withstand Voltage	By Type		MIL-STD-202 Method 301 Max. overload voltage for 1 minute
Thermal Shock	ΔR±0.05%	ΔR±0.25%	MIL-STD-202 Method 107G -55°C ~ 150°C, 100 cycles
Low Temperature Operation	ΔR±0.05%	ΔR±0.2%	JIS-C-5201-1 7.1 1 hour, -65°C, followed by 45 minutes of RCWV

RCWV(Rated continuous working voltage)= √(P\*R) or Max. Operating voltage whichever is lower

Storage Temperature: 25±3°C; Humidity < 80%RH

Derating Curve

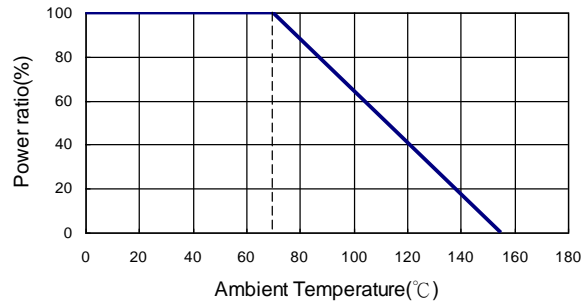

Construction and dimensions

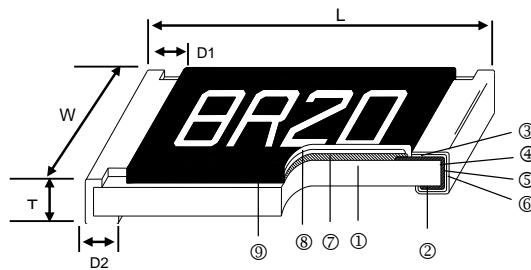

① Alumina Substrate	④ Edge Electrode (NiCr)	⑦ Resistor Layer (NiCr)
② Bottom Electrode (Ag)	⑤ Barrier Layer (Ni)	⑧ Overcoat (Epoxy)
③ Top Electrode (Ag)	⑥ External Electrode (Sn)	⑨ Marking

Size	L (mm)	W (mm)	T (mm)	D1 (mm)	D2 (mm)	Weight (g) (1000 Pcs.)
0201	0.58±0.05	0.29±0.05	0.23±0.05	0.12±0.05	0.15±0.05	0.14
0402	1.00±0.05	0.50±0.05	0.30±0.05	0.20±0.10	0.20±0.10	0.54
0603	1.55±0.10	0.80±0.10	0.45±0.10	0.30±0.20	0.30±0.20	1.83
0805	2.00±0.15	1.25±0.15	0.55±0.10	0.30±0.20	0.40±0.20	4.71
1206	3.05±0.15	1.55±0.15	0.55±0.10	0.42±0.20	0.35±0.25	9.02
1210	3.10±0.15	2.40±0.15	0.55±0.10	0.40±0.20	0.55±0.25	10
2010	4.90±0.15	2.40±0.15	0.55±0.10	0.60±0.30	0.50±0.25	23.61
2512	6.30±0.15	3.10±0.15	0.55±0.10	0.60±0.30	0.50±0.25	38.06

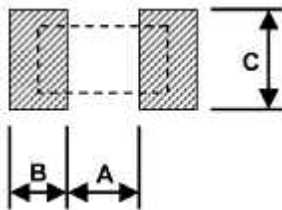

Size	Recommended Land Pattern		
	A	B	C
0201	0.25	0.30	0.40±0.2
0402	0.50	0.50	0.60±0.2
0603	0.80	1.00	0.90±0.2
0805	1.00	1.00	1.35±0.2
1206	2.00	1.15	1.70±0.2
1210	2.00	1.15	2.50±0.2
2010	3.60	1.40	2.50±0.2
2512	4.90	1.60	3.10±0.2

## Marking

Case sizes 0805 to 2512 IEC 4 Digit Marking:

Resistance	100R (100Ω)	2K2 (2.2kΩ)	10K (10kΩ)	499K (499kΩ)	100K (100kΩ)
Code	1000	2201	1002	4992	1003

Case Size 0603 E24 3 digit marking – Example 101 = 100R 102=1K0

E24	10	11	12	13	15	16	18	20	22	24	27	30
	33	36	39	43	47	51	56	62	68	75	82	91

Case size 0603 E96 3 digit marking – Examples 14C = 13K7 68B = 4K99 68X = 49R9

Code	E96	Code	E96	Code	E96	Code	E96
01	100	25	178	49	316	73	562
02	102	26	182	50	324	74	576
03	105	27	187	51	332	75	590
04	107	28	191	52	340	76	604
05	110	29	196	53	348	77	619
06	113	30	200	54	357	78	634
07	115	31	205	55	365	79	649
08	118	32	210	56	374	80	665
09	121	33	215	57	383	81	681
10	124	34	221	58	392	82	698
11	127	35	226	59	402	83	715
12	130	36	232	60	412	84	732
13	133	37	237	61	422	85	750
14	137	38	243	62	432	86	768
15	140	39	249	63	442	87	787
16	143	40	255	64	453	88	806
17	147	41	261	65	464	89	825
18	150	42	267	66	475	90	845
19	154	43	274	67	487	91	866
20	158	44	280	68	499	92	887
21	162	45	287	69	511	93	909
22	165	46	294	70	523	94	931
23	169	47	301	71	536	95	953
24	174	48	309	72	549	96	976

Code	A	B	C	D	E	F	G	H	X	Y	Z
Multiplier	10 <sup>0</sup>	10 <sup>1</sup>	10 <sup>2</sup>	10 <sup>3</sup>	10 <sup>4</sup>	10 <sup>5</sup>	10 <sup>6</sup>	10 <sup>7</sup>	10 <sup>-1</sup>	10 <sup>-2</sup>	10 <sup>-3</sup>

NB For case size 0603 values other than E24 and E96 resistors will be supplied unmarked.

All resistors smaller than 0603 supplied unmarked.

## Packaging

### Packing Quantity and Reel Specification

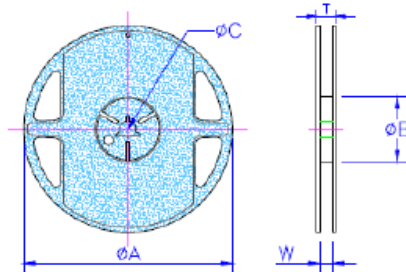

Size	$\phi A \pm 1.0$	$\phi B \pm 1.0$	$\phi C \pm 0.7$	$W \pm 1.0$	$T \pm 1.0$	Paper Tape	Embossed Plastic Tape
0201	178.0	60.0	13.5	9.5	11.5	1000 / 5000	N/A
0402							
0603							
0805							
1206							
1210							
2010				13.5	15.5	N/A	4000
2512							

### Paper tape Specification



Size	$A \pm 0.05$	$B \pm 0.05$	$W \pm 0.10$	$E \pm 0.05$	$F \pm 0.05$	$P_0$	$P_1$	$P_2 \pm 0.05$	$\phi D_0$	T
0201	0.40	0.70	8.00	1.75	3.5	4.00 $\pm 0.10$	2.00 $\pm 0.05$	2.00	1.55 $\pm 0.03$	0.42 $\pm 0.02$
0402	0.70	1.16								
0603	1.10	1.90							0.60 $\pm 0.03$	
0805	1.60	2.37					0.75 $\pm 0.05$			
1206	2.00	3.55								
1210	2.75	3.40								

### Peel force of top cover tape

The peel speed shall be about 300mm/min±5%

The peel force of top cover tape shall be between 8gf to 60gf

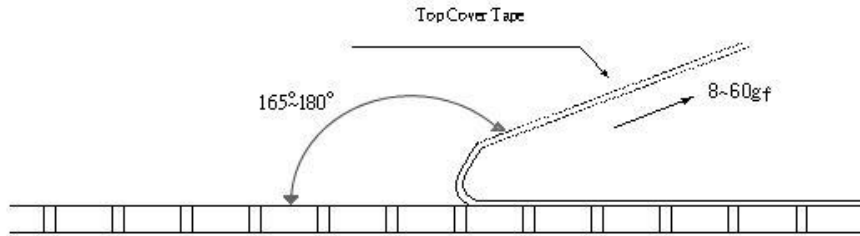

### Embossed Plastic Tape Specifications

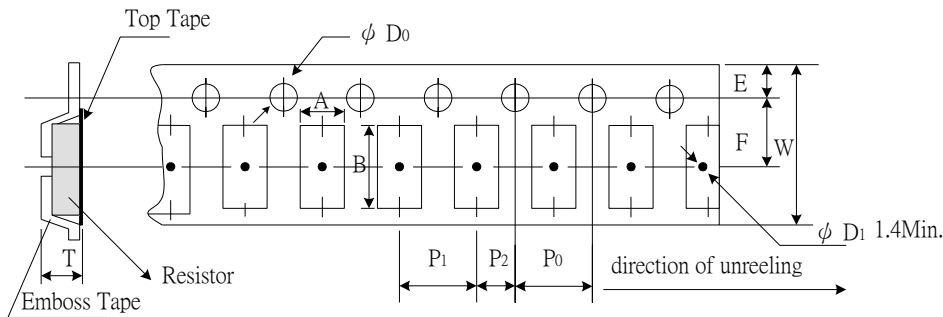

Type	A	B	W	E	F	P <sub>0</sub>	P <sub>1</sub>	P <sub>2</sub>	ØD <sub>0</sub>	T
2010	2.85±0.10	5.45±0.10	12.0±0.10	1.75±0.10	5.5±0.05	4.00±0.05	4.00±0.10	2.00±0.05	1.50±0.10	1.00±0.20
2512	3.40±0.10	6.65±0.10	12.0±0.10	1.75±0.10	5.5±0.05	4.00±0.05	4.00±0.10	2.00±0.05	1.50±0.10	1.00±0.20

### Peel force of top cover tape

The peel speed shall be about 300mm/min±5%

The peel force of top cover tape shall be between 20gf to 80g

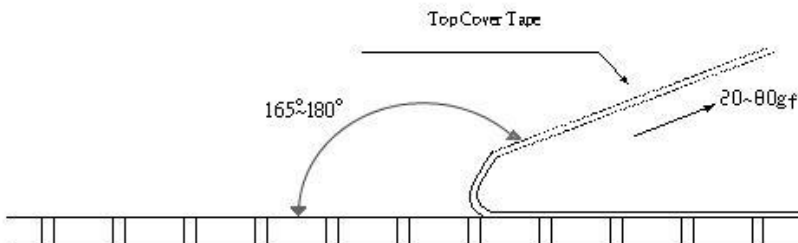



### Reflow Solder Profile

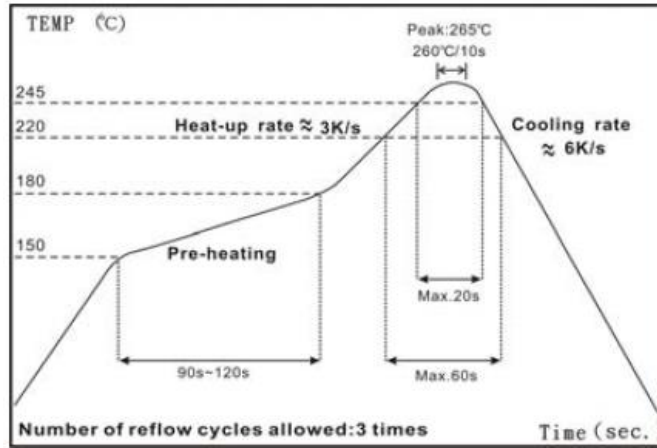

Time of Reflow soldering at maximum temperature point 260°C = 10s

### Wave Solder Profile

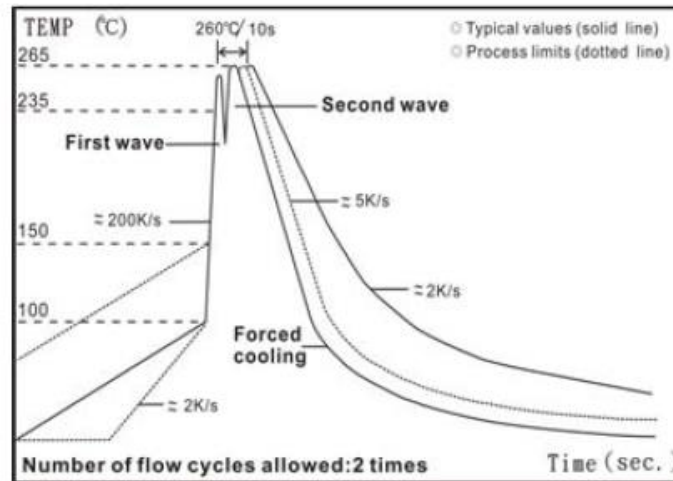

Time of Wave soldering at maximum temperature point 260°C = 10s

Time of Soldering Iron at maximum temperature point 410°C = 5s

### How To Order

CPF Common Part	0603 Package Size	B Tolerance	100R Value	E TCR	1 Packaging
CPF - precision thin film chip resistor	0201 1206 0402 1210 0603 2010 0805 2512	B - ±0.1% D - ±0.5% F - ±1%	100R - 100Ω 1K0 - 1000Ω 10K - 10,000Ω	D - 15PPM E - 25PPM C - 50PPM	1 - 1K REEL Blank - 5K REEL

Компания «Океан Электроники» предлагает заключение долгосрочных отношений при поставках импортных электронных компонентов на взаимовыгодных условиях!

Наши преимущества:

- Поставка оригинальных импортных электронных компонентов напрямую с производств Америки, Европы и Азии, а так же с крупнейших складов мира;
- Широкая линейка поставок активных и пассивных импортных электронных компонентов (более 30 млн. наименований);
- Поставка сложных, дефицитных, либо снятых с производства позиций;
- Оперативные сроки поставки под заказ (от 5 рабочих дней);
- Экспресс доставка в любую точку России;
- Помощь Конструкторского Отдела и консультации квалифицированных инженеров;
- Техническая поддержка проекта, помощь в подборе аналогов, поставка прототипов;
- Поставка электронных компонентов под контролем ВП;
- Система менеджмента качества сертифицирована по Международному стандарту ISO 9001;
- При необходимости вся продукция военного и аэрокосмического назначения проходит испытания и сертификацию в лаборатории (по согласованию с заказчиком);
- Поставка специализированных компонентов военного и аэрокосмического уровня качества (Xilinx, Altera, Analog Devices, Intersil, Interpoint, Microsemi, Actel, Aeroflex, Peregrine, VPT, Syfer, Eurofarad, Texas Instruments, MS Kennedy, Miteq, Cobham, E2V, MA-COM, Hittite, Mini-Circuits, General Dynamics и др.);

Компания «Океан Электроники» является официальным дистрибьютором и эксклюзивным представителем в России одного из крупнейших производителей разъемов военного и аэрокосмического назначения «JONHON», а так же официальным дистрибьютором и эксклюзивным представителем в России производителя высокотехнологичных и надежных решений для передачи СВЧ сигналов «FORSTAR».



## JONHON

«JONHON» (основан в 1970 г.)

Разъемы специального, военного и аэрокосмического назначения:

(Применяются в военной, авиационной, аэрокосмической, морской, железнодорожной, горно- и нефтедобывающей отраслях промышленности)

«FORSTAR» (основан в 1998 г.)

ВЧ соединители, коаксиальные кабели, кабельные сборки и микроволновые компоненты:

(Применяются в телекоммуникациях гражданского и специального назначения, в средствах связи, РЛС, а так же военной, авиационной и аэрокосмической отраслях промышленности).



Телефон: 8 (812) 309-75-97 (многоканальный)

Факс: 8 (812) 320-03-32

Электронная почта: [ocean@oceanchips.ru](mailto:ocean@oceanchips.ru)

Web: <http://oceanchips.ru/>

Адрес: 198099, г. Санкт-Петербург, ул. Калинина, д. 2, корп. 4, лит. А