

μCom-10Gb +

Harsh Environment 10Gb
Ethernet Micro Connectors



μCom-Series is a new range of connectors designed to address the latest trends of the industry : **miniaturization** and **high speed**, with the highest resistance for use in the **harshest environments**.

MAIN FEATURES

- 10Gb+: exceeds 10Gb/s Ethernet following IEEE 802.3an-2006 : **10GBase-T**
- Cat.6A connector according to TIA568C.2 and ISO/IEC11801 standard
- Environmental testing based on **MIL-DTL-38999 series III** military specifications (Thread version)
- Environmental testing based on **MIL-DTL-26482** military specifications (Push Pull version)
- Miniature : **15 mm(.59") max** external diameter
- Receptacle and in-line receptacle compatible with both thread and Push Pull plugs

FEATURES AND BENEFITS

- 4 pairs totally insulated throughout the connector
 - ➔ minimum cross-talk between the four pairs
- Patented special interfacial shapes
 - ➔ minimum perturbation at the interface of each pair
- Thread and Push Pull coupling mechanisms
 - ➔ 2000 mating cycles & high vibration resistance
- Machined Brass shells
 - ➔ Plating available:
 - Olive Drab Cadmium → not ROHS compliant
 - Black Nickel, and unplated brass → ROHS compliant
 - ➔ shell to shell continuity and 500h salt spray resistance
- Machined & gold plated Solder and Crimp contacts
 - ➔ design & performance according to the innercontact of M39029/77-429#16 M39029/76-425#16 38999 contact
 - ➔ contacts are crimped with standard crimping tool M22520/2-01 + Amphenol μCom positioner
- Solder contact : max AWG24
- Crimp contact : AWG 24 to 28
- IP68 sealing mated and unmated for PCB receptacles
- 1500 Vrms Dielectric Withstanding Voltage
- Temperature range : - 55°C / + 125°C

MARKETS & APPLICATIONS

- **MILITARY**: C4ISR, Battlefield Communications, Shipboard, Ground Vehicles Vetronics.
- **AEROSPACE** : In Flight Entertainment*, Avionics*, Communication Systems.

*μCom approved by GORE



TRANSMISSION DATA

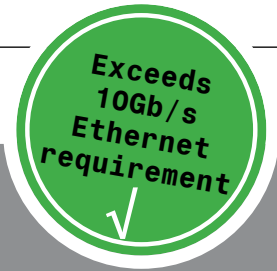

Insertion Loss (IL) :

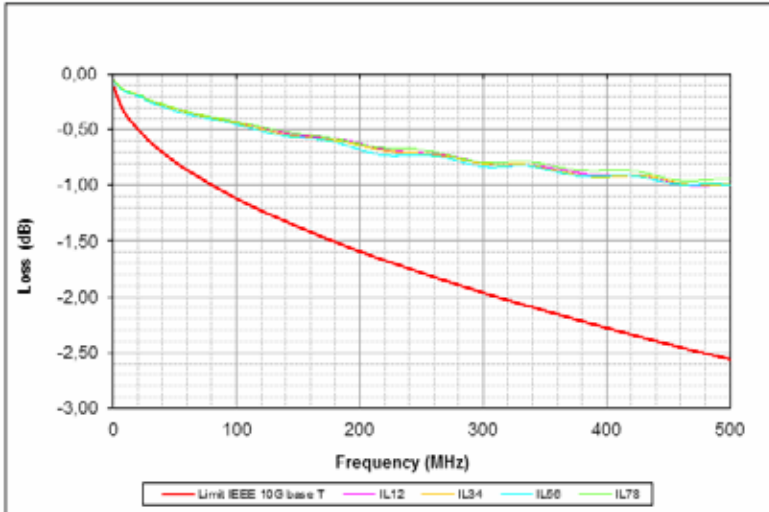

← Amphenol performance

← IEEE 802.3an Standard requirement

Near End crosstalk (NEXT) :

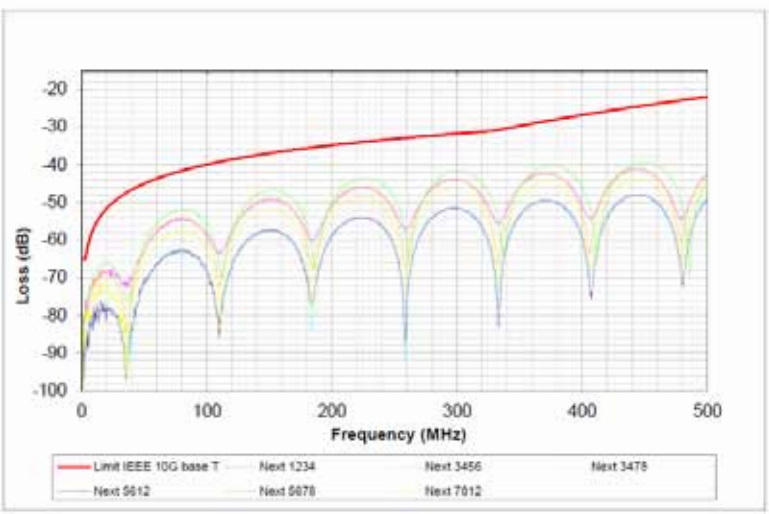

← IEEE 802.3an Standard requirement

← Amphenol performance

Return Loss (RL) :

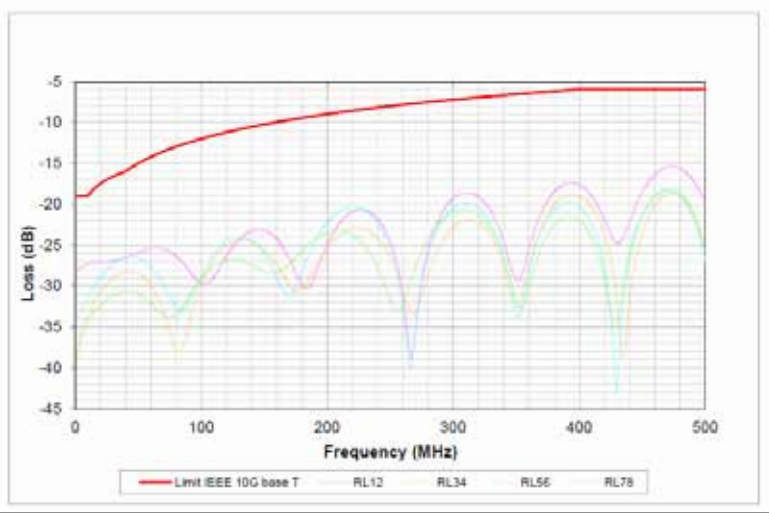

← IEEE 802.3an Standard requirement

← Amphenol performance

FEMALE RECEPTACLES



Female receptacle for printed circuit board

Compatible with both thread & push pull plugs

Part number: UCOM-10G+ R P X

X: see the 'How to order' below to complete your part number

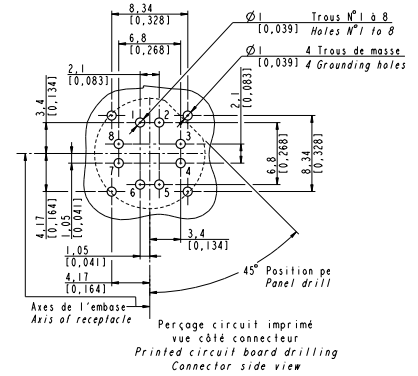
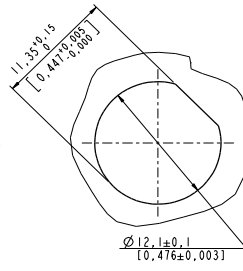
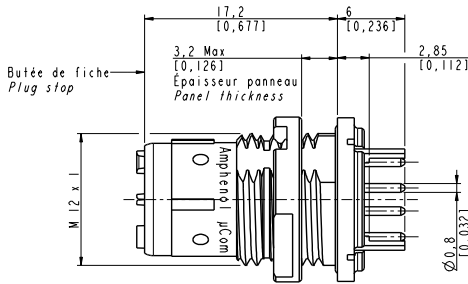

Panel mount female receptacle with metallic band backshell

Compatible with both thread & push pull plugs

Part number: UCOM-10G+ R X X

X: see the 'How to order' below to complete your part number

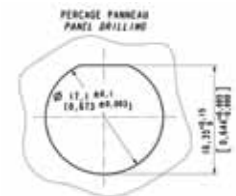
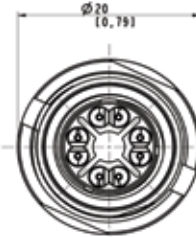
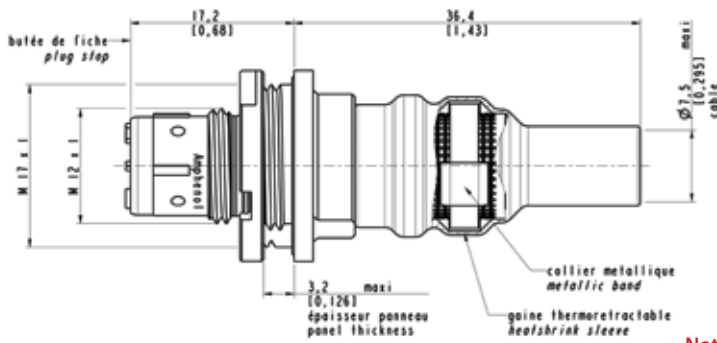

Nota: metallic band and heatshrink sleeve are provided with the connector

HOW TO ORDER Female receptacles

UCOM - 10G+ R P B

Shell

R: receptacle (push pull or thread)

Contacts termination

P: PCB

S: solder

C: crimp

Shell plating

B: black nickel

G: olive drab cadmium

U: unplated brass

NOTA:

- UCOM for order designation
- µCom for marking on connectors

MALE PLUGS



Plug with cable gland backshell

Part number: **UCOM-10G+ P T x x G x**
x: see the 'How to order' below to complete your part number

Part number: **UCOM-10G+ P P x x G x**
x: see the 'How to order' below to complete your part number

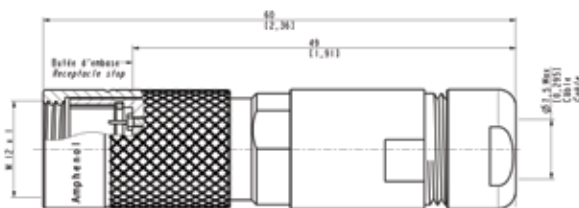

Thread version

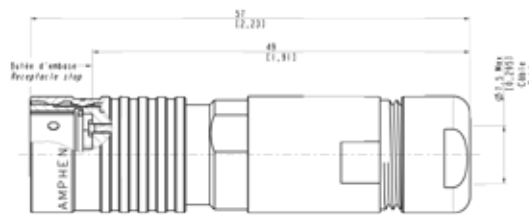
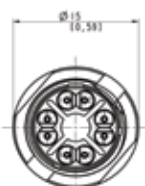

Push Pull version



Plug with metallic band backshell

Part number: **UCOM-10G+ P T x x B**
x: see the 'How to order' below to complete your part number

Part number: **UCOM-10G+ P P x x B**
x: see the 'How to order' below to complete your part number

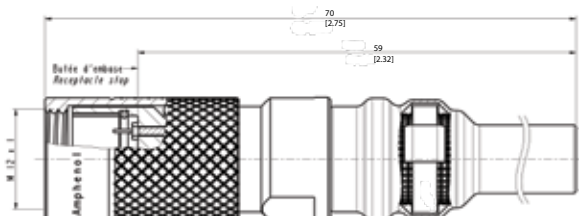

Thread version

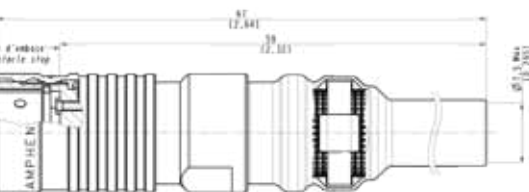
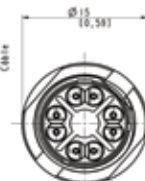

Push Pull version

Nota: Metallic band and heatshrink sleeve are provided with the connector

HOW TO ORDER Male plugs

	UCOM - 10G+	P	T	C	B	G	A
Shell P: plug							
Mating (for plugs only) T: thread P: push-pull							
Contacts termination C: crimp S: solder							
Shell plating B: black nickel G: olive drab cadmium U: unplated brass							
Backshell type G: gland B: band							
Cable diameter (for gland backshell only) A: for cable diam 7.5mm							

For other cable diameter, please consult us

NOTA:

- UCOM for order designation
- μCom for marking on connectors

FEMALE IN-LINE RECEPTACLES

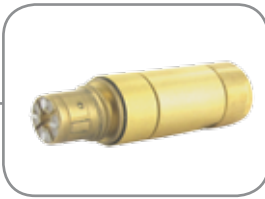

Female in-line receptacle with cable gland backshell

Compatible with both thread & push pull plugs

Part number: UCOM-10G+ L x G x
 x: see the 'How to order' below to complete your part number

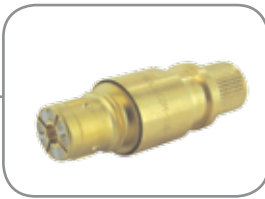
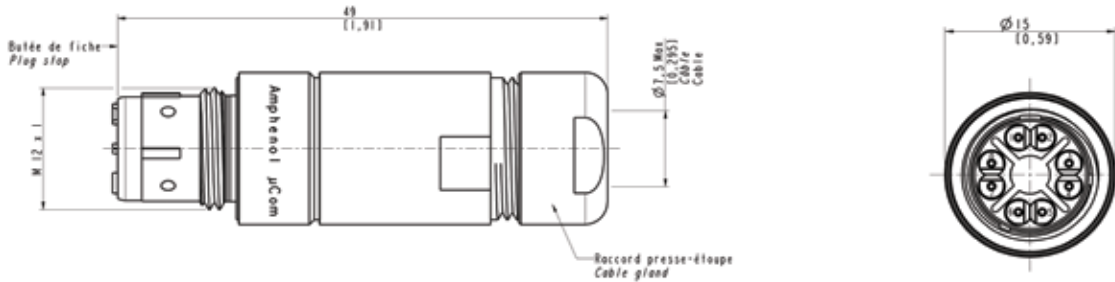

Female in-line receptacle with metallic band backshell

Compatible with both thread & push pull plugs

Part number: UCOM-10G+ L x B
 x: see the 'How to order' below to complete your part number

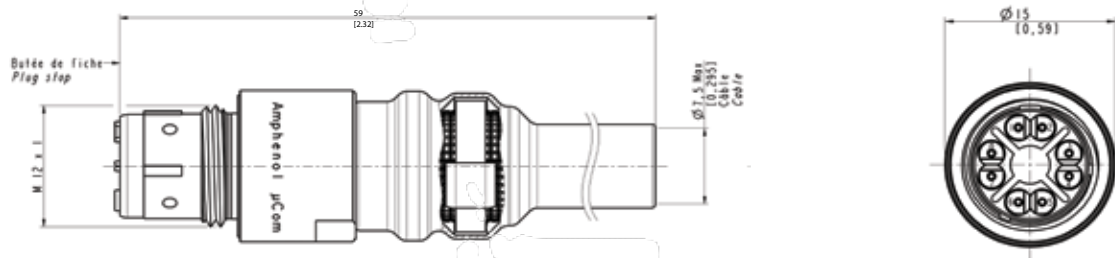

Nota: Metallic band and heatshrink sleeve are provided with the connector

HOW TO ORDER Female in-line receptacles

	UCOM - 10G+	L	S	B	G	A
Shell						
L: in line receptacle (push pull or thread)						
Contacts termination						
C: crimp						
S: solder						
Shell plating						
B: black nickel						
G: olive drab cadmium						
U: unplated brass						
Backshell type						
G: gland						
B: band						
Cable diameter (for gland backshell only)						
A: for cable diam 7.5mm						

- NOTA:**
- UCOM for order designation
 - μCom for marking on connectors

For other cable diameter, please consult us

CORDSETS



New cabling configuration		
Cable number		Connector number
1	White / Orange	1
2	Orange	2
3	White / green	3
6	Green	4
5	White / Blue	5
4	Blue	6
7	White / Brown	7
8	Brown	8

μCom plug - μCom plug cordset

Part number:
UCOM-10G+ C x x x xxx

x: see the 'How to order' on the next page to complete your part number

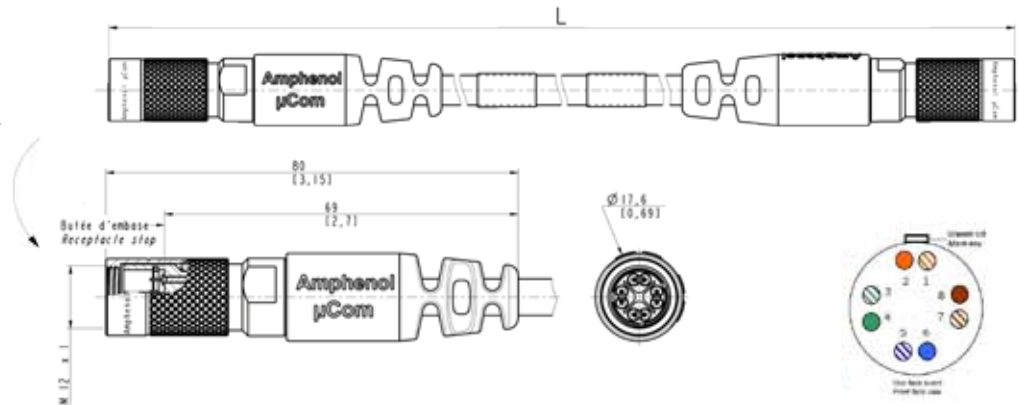

μCom plug - RJ45 Cat6A plug cordset

Part number:
UCOM-10G+ D x x x xxx

x: see the 'How to order' on the next page to complete your part number

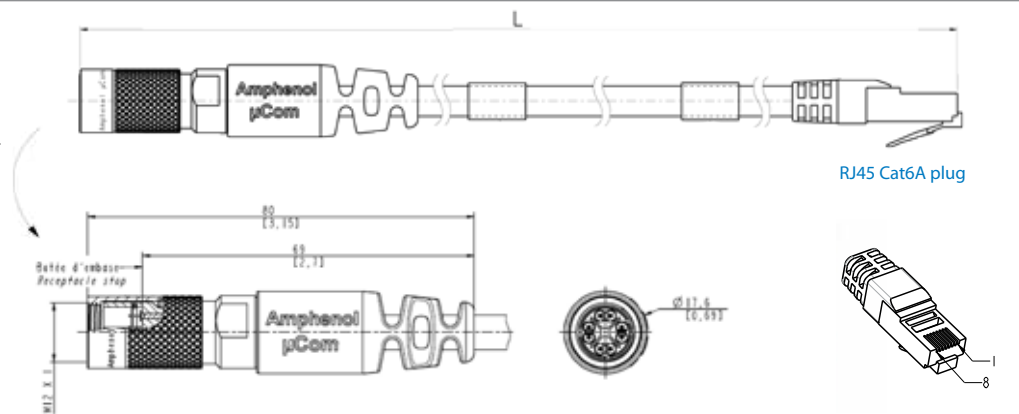

μCom panel mount receptacle - RJ45 Cat6A plug

Part number:
UCOM-10G+ E x x x xxx

x: see the 'How to order' on the next page to complete your part number

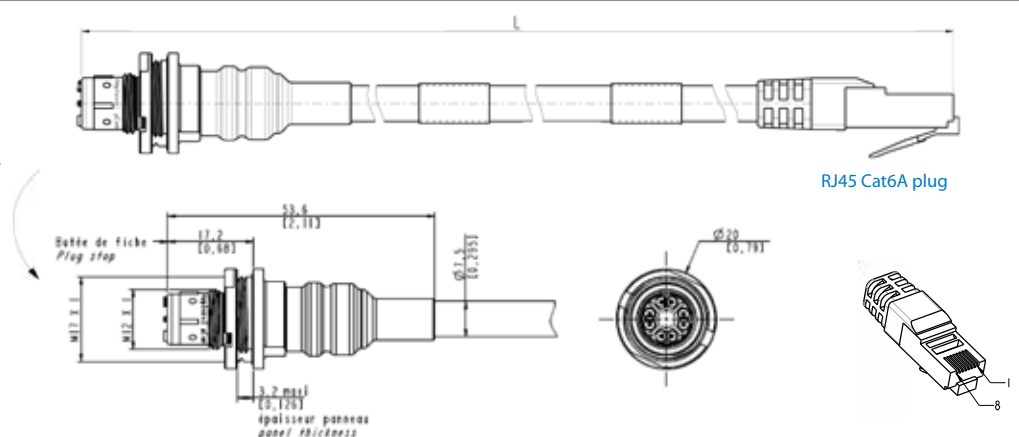

μCom plug - μCom inline receptacle

Part number:

UCOM-10G+ F x x x xxx

x: see the 'How to order' below to complete your part number

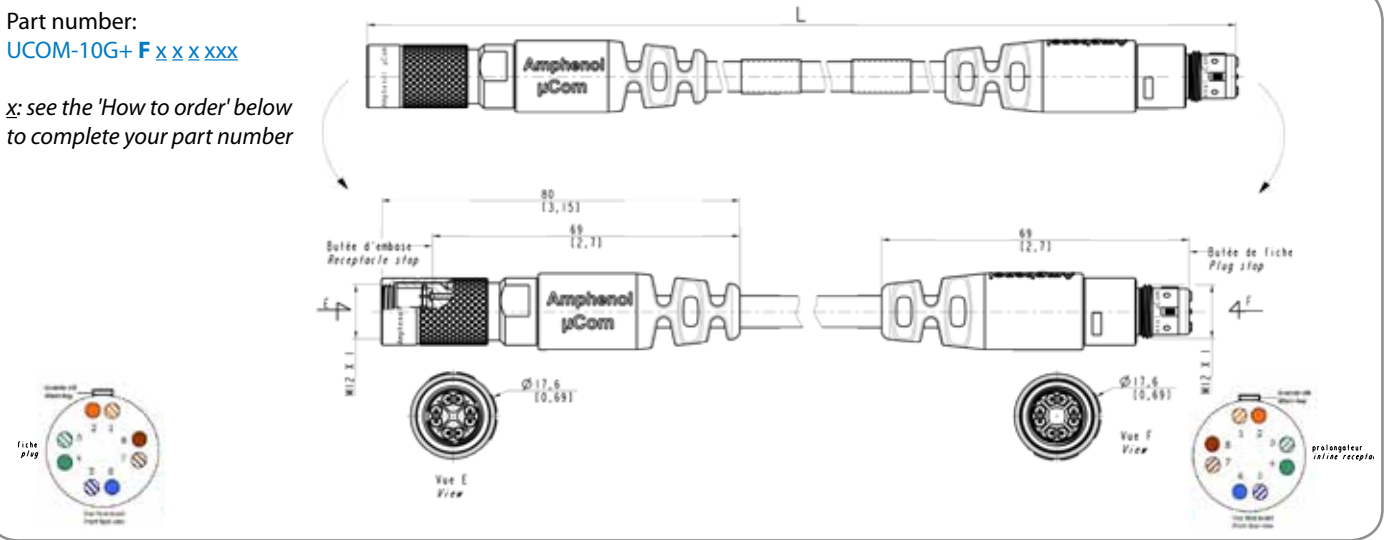

Type of cable used: CAT 7 HFFR - According to EN 50288-4-2



- Stranded bare copper wire (26 AWG)
- 4 screened twisted pairs: 2 wires twisted to a pair, Alulamine foil overlapped
- Shield braiding of tinned copper wires, about 80% coverage
- Strain member of Kevlar
- Jacket in black Polyurethane (PUR), glossy finish, acc to DIN VDE 0282
- External diameter 7.0 +/-0.3 mm
- UV & Hydrolysis resistant, Halogen free, RoHS compliant
- Max Pull force: 800 N, Weight : about 54 kg/km
- Temperature : - 40°C / + 85°C
- Min. bending radius allowed: repeated 8 x Ø, single 4 x Ø

GORE® has approved μCom assembled onto their cat6A cable P/N : RCN9034-24. Information available on GORE® website.

HOW TO ORDER Cordsets

UCOM - 10G+ C T C B 015

Shell

- C: μCom plug - μCom plug cordset
 - D: μCom plug - RJ45 Cat6A plug cordset
 - E: μCom panel mount receptacle - RJ45 Cat6A plug cordset
 - F: μCom plug - μCom inline receptacle cordset
- Open versions:
- G: μCom plug - no connector at the end
 - H: μCom panel mount receptacle - no connector at the end
 - J: μCom inline receptacle - no connector at the end

Mating (for plugs only)
T: thread

Contacts termination

- C: crimp
- S: solder

Shell plating

- B: black nickel
- G: olive drab cadmium
- U: unplated brass

Total length - For other lengths, please consult us.

- 002: 20 cm [7.87]
- 005: 50 cm [19.68]
- 010: 1.0 m [39.37]
- 015: 1.5 m [59.05]
- 020: 2.0 m [78.74]
- 050: 5.0 m [196.85]
- 100: 10.0 m [393.70]

NOTA:

- UCOM for order designation
- μCom for marking on connectors

ACCESSORIES

CAPS for receptacles

IP68 metallic cap

X to be replaced by
B for Black electrophoresis plating
G for Olive drab cadmium plating
U for Unplated brass

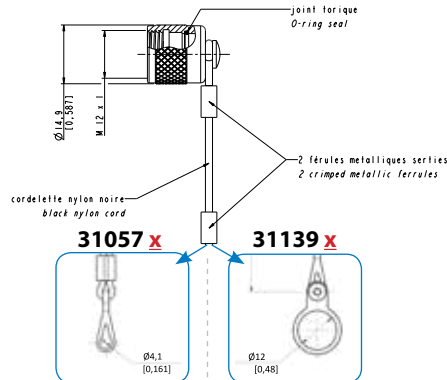

IP68 metallic cap with metallic tie on panel Or IP68 metallic cap with a Ø12 fixation ring
 Nota: plan a hole on the panel

IP68 neoprene cap - Part number: **31091**
 Nota: plan a type M3 hole on the panel



CAPS for plugs

Cap in neoprene
 Part number: **31092**



CAPS for in line receptacles

Cap in neoprene
 Part number: **31093**



Dummy female receptacle

Part number: **31131 X**

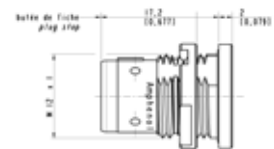

X to be replaced by
B for Black nickel plating
G for Olive drab cadmium plating
U for Unplated brass

SPARES

Crimp Pin
 Part number: **31073**



Crimp Socket
 Part number: **31074**



TOOLS



- Nut clamping tool for receptacle
 Part number: **31055**
 Only for RPx receptacles



- Insertion tool for crimp contacts
 Part number: **31056**



- Contact positioner for M22520/2-01 crimping tool
 Part number: **31095**

Other tools:

- Brazing tool for receptacle & in-line receptacle
 Part number: **31132**
- Brazing tool for plug
 Part number: **31133**

Nota: the cabling instructions are available upon demand (ref. N00-040190-00).

Компания «Океан Электроники» предлагает заключение долгосрочных отношений при поставках импортных электронных компонентов на взаимовыгодных условиях!

Наши преимущества:

- Поставка оригинальных импортных электронных компонентов напрямую с производств Америки, Европы и Азии, а так же с крупнейших складов мира;
- Широкая линейка поставок активных и пассивных импортных электронных компонентов (более 30 млн. наименований);
- Поставка сложных, дефицитных, либо снятых с производства позиций;
- Оперативные сроки поставки под заказ (от 5 рабочих дней);
- Экспресс доставка в любую точку России;
- Помощь Конструкторского Отдела и консультации квалифицированных инженеров;
- Техническая поддержка проекта, помощь в подборе аналогов, поставка прототипов;
- Поставка электронных компонентов под контролем ВП;
- Система менеджмента качества сертифицирована по Международному стандарту ISO 9001;
- При необходимости вся продукция военного и аэрокосмического назначения проходит испытания и сертификацию в лаборатории (по согласованию с заказчиком);
- Поставка специализированных компонентов военного и аэрокосмического уровня качества (Xilinx, Altera, Analog Devices, Intersil, Interpoint, Microsemi, Actel, Aeroflex, Peregrine, VPT, Syfer, Eurofarad, Texas Instruments, MS Kennedy, Miteq, Cobham, E2V, MA-COM, Hittite, Mini-Circuits, General Dynamics и др.);

Компания «Океан Электроники» является официальным дистрибьютором и эксклюзивным представителем в России одного из крупнейших производителей разъемов военного и аэрокосмического назначения «JONHON», а так же официальным дистрибьютором и эксклюзивным представителем в России производителя высокотехнологичных и надежных решений для передачи СВЧ сигналов «FORSTAR».



JONHON

«JONHON» (основан в 1970 г.)

Разъемы специального, военного и аэрокосмического назначения:

(Применяются в военной, авиационной, аэрокосмической, морской, железнодорожной, горно- и нефтедобывающей отраслях промышленности)

«FORSTAR» (основан в 1998 г.)

ВЧ соединители, коаксиальные кабели, кабельные сборки и микроволновые компоненты:

(Применяются в телекоммуникациях гражданского и специального назначения, в средствах связи, РЛС, а так же военной, авиационной и аэрокосмической отраслях промышленности).



Телефон: 8 (812) 309-75-97 (многоканальный)

Факс: 8 (812) 320-03-32

Электронная почта: ocean@oceanchips.ru

Web: <http://oceanchips.ru/>

Адрес: 198099, г. Санкт-Петербург, ул. Калинина, д. 2, корп. 4, лит. А