

DATA SHEET

SKY13446-374LF: 0.1 to 6.0 GHz GaAs SPDT Switch

Applications

- Dual-band WLAN systems
- 802.11 a/b/g/n transmit/receive systems

Features

- Positive low voltage control: 0 and 3.0 V
- Low insertion loss: 0.40 dB @ 2.5 GHz and 0.80 dB @ 6.0 GHz
- High isolation: 38 dB @ 2.4 GHz and 30 dB @ 6 GHz
- Excellent linearity performance: P1dB = +32 dBm
- Advanced pHEMT process
- Ultra-thin, miniature MLPD (6-pin, 1.5 x 1.5 x 0.45 mm) package (MSL1, 260 °C per JEDEC J-STD-020)



Skyworks Green™ products are compliant with all applicable legislation and are halogen-free. For additional information, refer to *Skyworks Definition of Green™*, document number SQ04-0074.

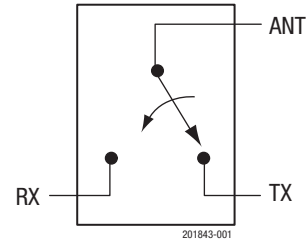

Figure 1. SKY13446-374LF Block Diagram

Description

The SKY13446-374LF is a pHEMT GaAs I/C antenna switch. Switching between the antenna and TX or RX ports is accomplished with two control voltages. The low-loss, high isolation, high linearity, small size and low cost make this switch ideal for all dual-band WLAN systems that operate at 2.4 to 2.5 GHz and 4.9 to 5.9 GHz.

The switch is manufactured in a compact, 1.5 x 1.5 mm, 6-pin exposed pad plastic Micro Leadframe Package Dual (MLPD) package.

A functional block diagram is shown in Figure 1. The pin configuration and package are shown in Figure 2. Signal pin assignments and functional pin descriptions are provided in Table 1.

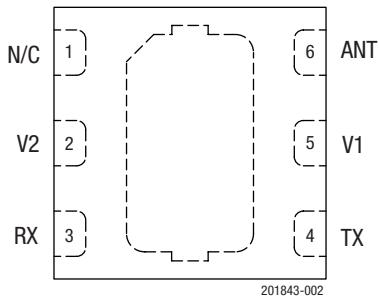

Figure 2. SKY13446-374LF Pinout (Top View)

Table 1. SKY13446-374LF Signal Descriptions¹

Pin	Name	Description	Pin	Name	Description
1	N/C	No connection	4	TX	RF port (must be DC blocked)
2	V2	DC control voltage	5	V1	DC control voltage
3	RX	RF port (must be DC blocked)	6	ANT	RF common port (must be DC blocked)

¹ Bottom ground paddle should be connected to ground for best operation.

Electrical and Mechanical Specifications

The absolute maximum ratings of the SKY13446-374LF are provided in Table 2. Electrical specifications are provided in Table 3.

The state of the SKY13446-374LF is determined by the logic provided in Table 4. Typical performance characteristics are shown in Figures 3 through 7.

Table 2. SKY13446-374LF Absolute Maximum Ratings

Parameter	Symbol	Minimum	Maximum	Units
Input power @ 0 and 3 V	P _{IN}		+33	dBm
Input power @ 0 and 5 V	P _{IN}		+35	dBm
Operating voltage	V _{CTL}		6.0	V
Storage temperature	T _{STG}	-65	+150	°C
Operating temperature	T _{OP}	-40	+85	°C

ESD HANDLING: *Although this device is designed to be as robust as possible, electrostatic discharge (ESD) can damage this device. This device must be protected at all times from ESD when handling or transporting. Static charges may easily produce potentials of several kilovolts on the human body or equipment, which can discharge without detection. Industry-standard ESD handling precautions should be used at all times.*

Table 3. SKY13446-374LF Electrical Specifications¹**(V_{CTL} = 0 V and +3.0 V, T_{OP} = +25 °C, P_{IN} = 0 dBm, Characteristic Impedance [Z₀] = 50 Ω, Unless Otherwise Noted)**

Parameter	Symbol	Test Condition	Min	Typ	Max	Units
Insertion loss, ANT to TX and RX ports		2.4-2.5 GHz		0.4	0.6	dB
		0.1-3.0 GHz		0.5	0.7	dB
		3.0-6.0 GHz		0.8	1.0	dB
Isolation, ANT to TX and RX ports		2.4-2.5 GHz	33	38		dB
		0.1-3.0 GHz	32	38		dB
		3.0-6.0 GHz	27	30		dB
Return loss, ANT to TX and RX ports (insertion loss state) ²		2.4-2.5 GHz	14	21		dB
		0.1-3.0 GHz	12	18		dB
		3.0-6.0 GHz	10	15		dB
Switching characteristics: Rise/fall time		10/90% or 90/10% RF		50		ns
		On/off time		150		ns
Video feedthrough		T _{RISE} = 1 ns @ 500 MHz		50		mV
Input power for 1 dB compression	P1dB	V _{CTL} = 0 and 3.0 V, 2.4-2.5 GHz 4.9-5.9 GHz		+33		dBm
				+32		dBm
		V _{CTL} = 0 and 1.8 V, 2.4-2.5 GHz 4.9-5.9 GHz		+26		dBm
				+23		dBm
Error vector magnitude	EVM	802.11a, 54 Mbps, P _{IN} = <+23 dBm, V _{CTL} = 3 V		2.5		%
		802.11g, 54 Mbps, P _{IN} = <+26 dBm, V _{CTL} = 3 V		2.5		%
Control voltage: High	V _{CTL_H} V _{CTL_L}		1.80	3.30	5.00	V
				0	0.25	V
Leakage current		V _{CTL_H} and V _{CTL_L}		5	50	μA

¹ Performance is guaranteed only under the conditions listed in this table.² Low frequency return loss is limited by the value of DC blocking capacitors (22 pF).**Table 4. SKY13446-374LF Truth Table¹**

V1 (Pin 5)	V2 (Pin 2)	ANT to RX Path	ANT to TX Path
1	0	Insertion loss	Isolation
0	1	Isolation	Insertion loss

¹ "1" = +1.8 V to +5.0 V. "0" = 0 V to +0.25 V. Any state other than described in this table places the switch into an undefined state. An undefined state will not damage the device.

Typical Performance Characteristics

(V_{CTL} = 0 V and +3.0 V, T_{OP} = +25 °C, P_{IN} = 0 dBm, Characteristic Impedance [Z₀] = 50 Ω, Unless Otherwise Noted)

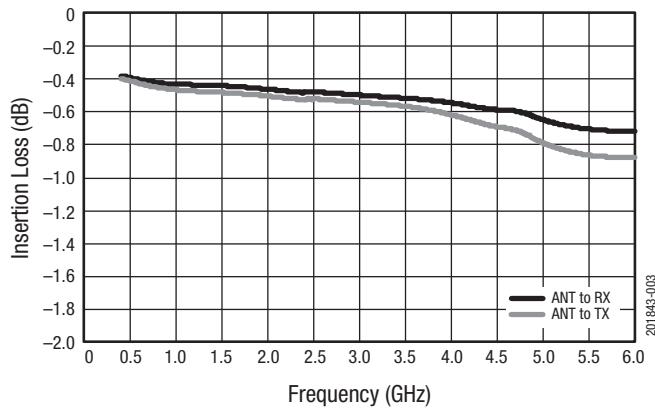

Figure 3. Insertion Loss vs Frequency

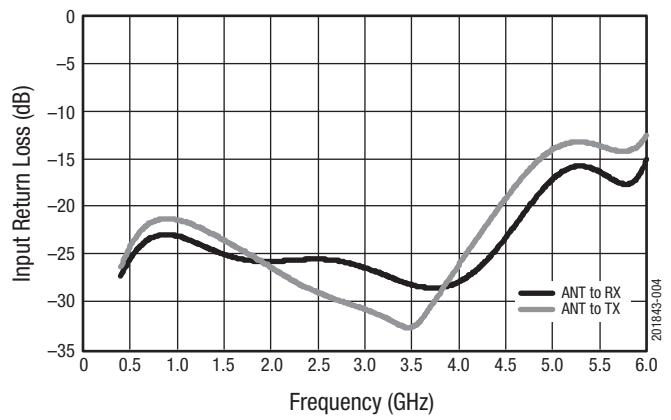

Figure 4. Input Return Loss vs Frequency

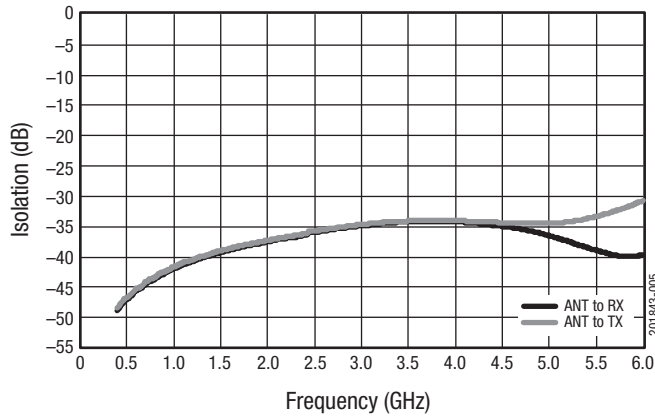

Figure 5. Isolation vs Frequency

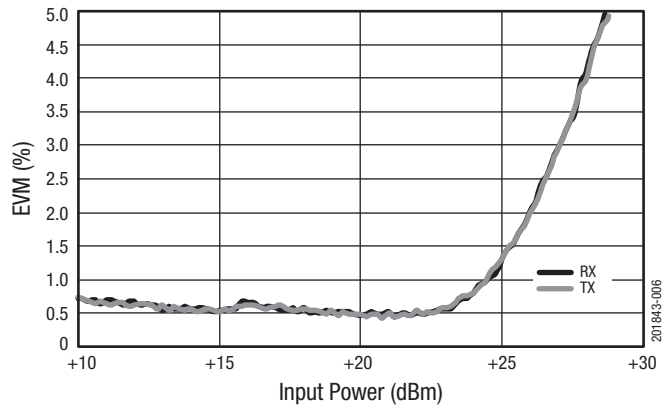

Figure 6. EVM vs Input Power
(@ 2.45 GHz, 54 bps)

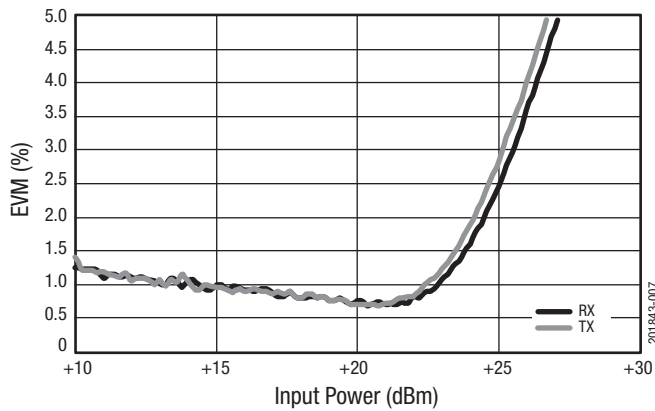

Figure 7. EVM vs Input Power
(@ 5.5 GHz, 54 bps)

Evaluation Board Description

The SKY13446-374LF Evaluation Board is used to test the performance of the SKY13446-374LF SPDT Switch. An Evaluation Board schematic diagram is provided in Figure 8. An assembly drawing for the Evaluation Board is shown in Figure 9.

Package Dimensions

The PCB layout footprint for the SKY13446-374LF is provided in Figure 10. Typical part markings are shown in Figure 11. Package dimensions are shown in Figure 12, and tape and reel dimensions are provided in Figure 13.

Package and Handling Information

Instructions on the shipping container label regarding exposure to moisture after the container seal is broken must be followed. Otherwise, problems related to moisture absorption may occur when the part is subjected to high temperature during solder assembly.

The SKY13446-374LF is rated to Moisture Sensitivity Level 1 (MSL1) at 260 °C. It can be used for lead or lead-free soldering.

Care must be taken when attaching this product, whether it is done manually or in a production solder reflow environment. Production quantities of this product are shipped in a standard tape and reel format.

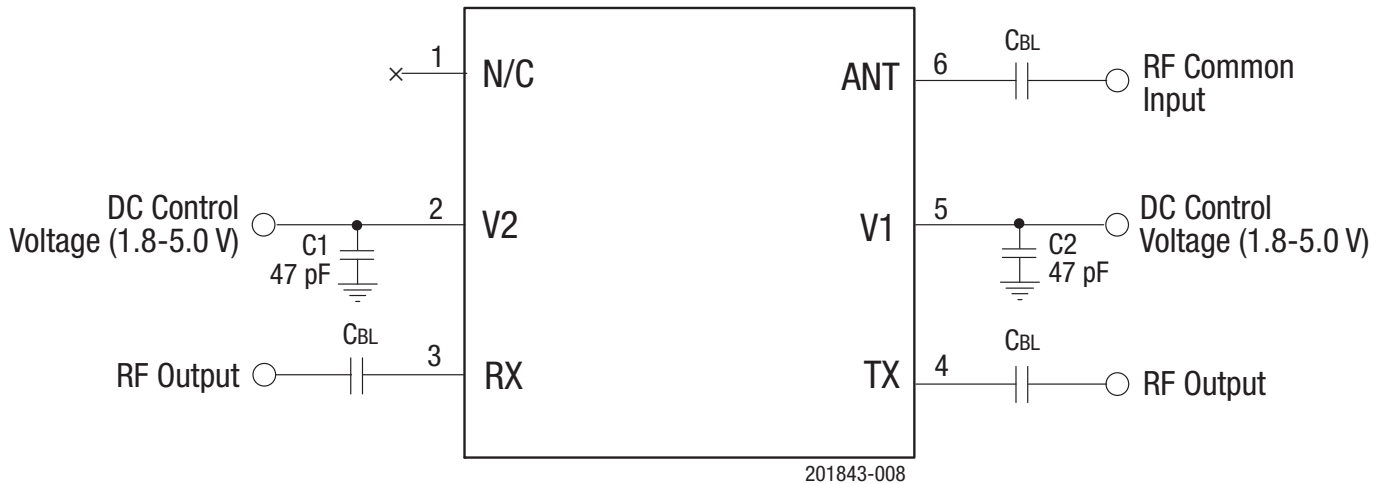

*C_{B/L} = 22 pF for 2.4-6.0 GHz operation.
Exposed ground paddle should be grounded
for best performance.*

Figure 8. SKY13446-374LF Evaluation Board Schematic

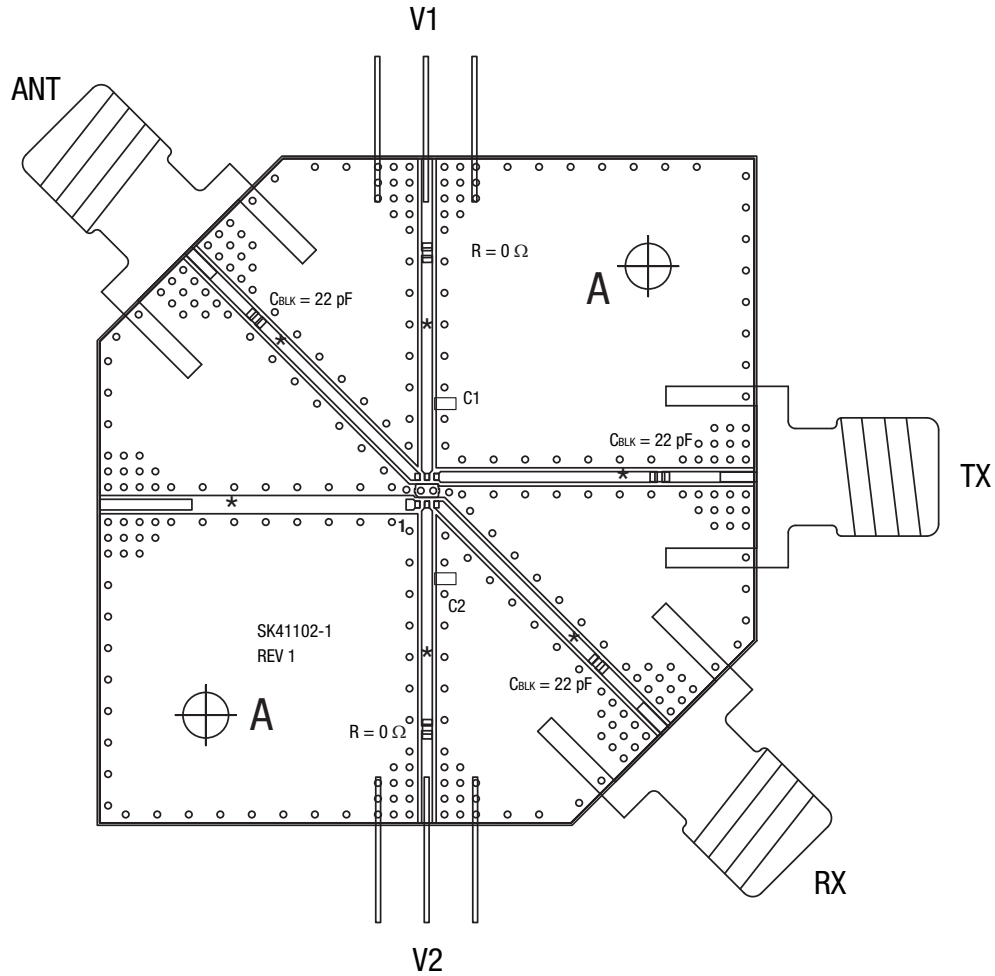

R = 0 Ω (0402 size) 2 places
 C_{BLK} = 15 pF (0402 size) 3 places
 C1 and C2 = 47 pF (0402 size), 2 places

201843-009

Figure 9. SKY13446-374LF Evaluation Board Assembly Diagram

DATA SHEET • SKY13446-374LF: SPDT SWITCH

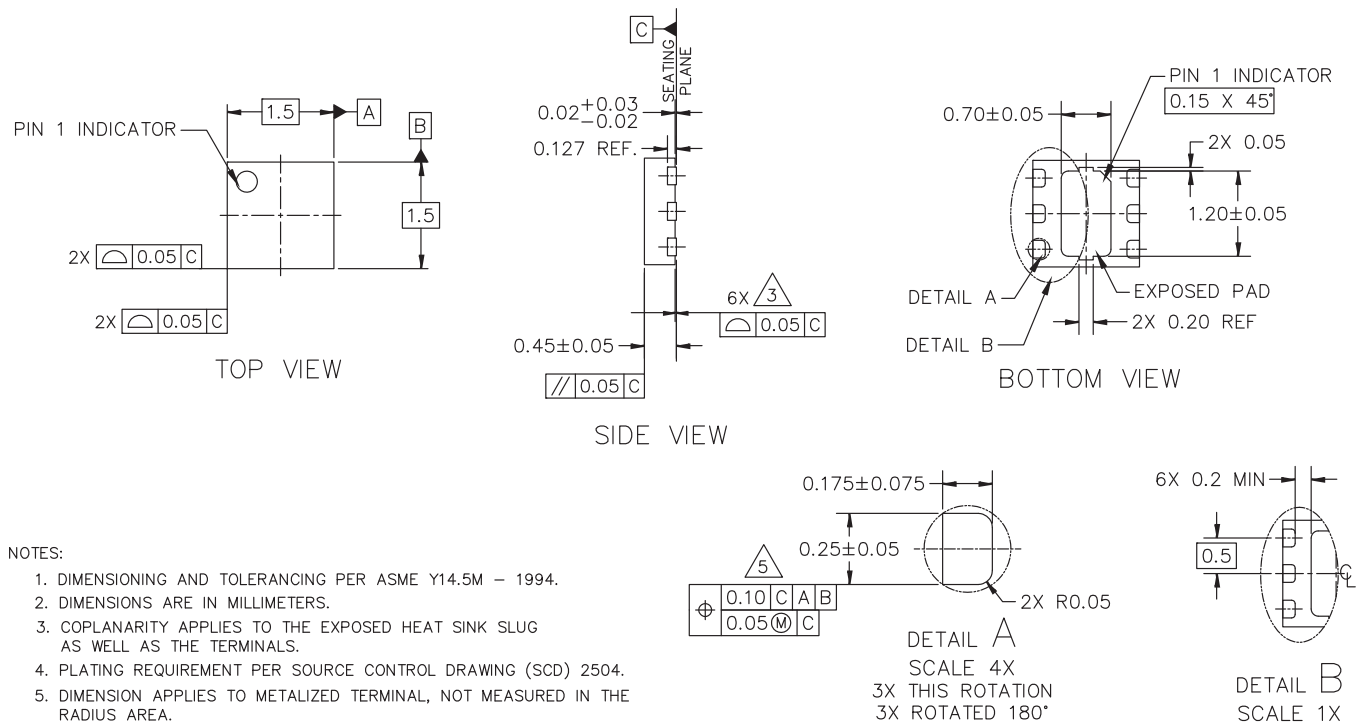

NOTES:

1. DIMENSIONING AND TOLERANCING PER ASME Y14.5M - 1994.
2. DIMENSIONS ARE IN MILLIMETERS.
3. COPLANARITY APPLIES TO THE EXPOSED HEAT SINK SLUG AS WELL AS THE TERMINALS.
4. PLATING REQUIREMENT PER SOURCE CONTROL DRAWING (SCD) 2504.
5. DIMENSION APPLIES TO METALIZED TERMINAL, NOT MEASURED IN THE RADIUS AREA.

201843-012

Figure 12. SKY13446-374LF Package Dimensions

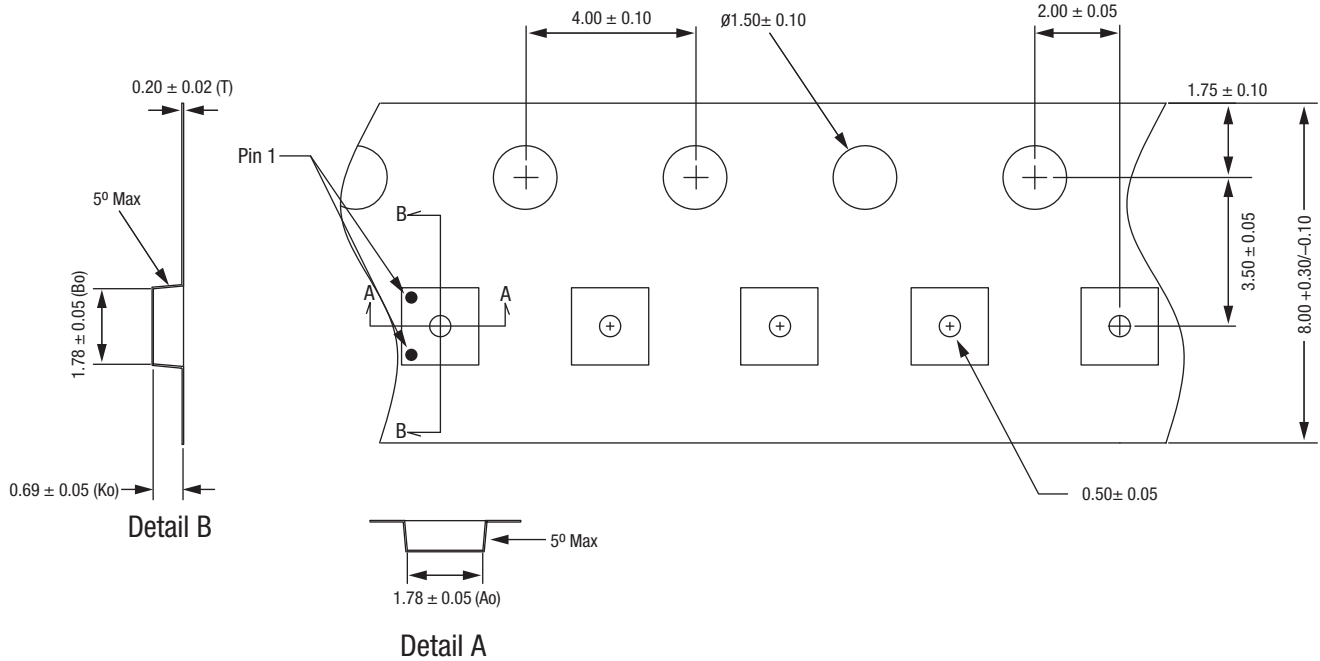

Notes:

1. Carrier tape: black conductive polycarbonate or polystyrene.
2. Cover tape material: transparent conductive PSA.
3. Cover tape size: 5.4 mm width.
4. All measurements are in millimeters.
5. Pin 1 orientation is in lower left corner for SOT-666 packages.
Pin 1 orientation is in upper left corner for 1.5 x 1.5 mm MLPD, QFN, and DFN packages.

201843-012

Figure 13. SKY13446-374LF Tape and Reel Dimensions

Ordering Information

Product Description	Product Part Number	Evaluation Board Part Number
SKY13446-374LF: SPDT Switch	SKY13446-374LF	SKY13446-374LF-EVB

Copyright © 2012-2013, 2018 Skyworks Solutions, Inc. All Rights Reserved.

Information in this document is provided in connection with Skyworks Solutions, Inc. (“Skyworks”) products or services. These materials, including the information contained herein, are provided by Skyworks as a service to its customers and may be used for informational purposes only by the customer. Skyworks assumes no responsibility for errors or omissions in these materials or the information contained herein. Skyworks may change its documentation, products, services, specifications or product descriptions at any time, without notice. Skyworks makes no commitment to update the materials or information and shall have no responsibility whatsoever for conflicts, incompatibilities, or other difficulties arising from any future changes.

No license, whether express, implied, by estoppel or otherwise, is granted to any intellectual property rights by this document. Skyworks assumes no liability for any materials, products or information provided hereunder, including the sale, distribution, reproduction or use of Skyworks products, information or materials, except as may be provided in Skyworks Terms and Conditions of Sale.

THE MATERIALS, PRODUCTS AND INFORMATION ARE PROVIDED “AS IS” WITHOUT WARRANTY OF ANY KIND, WHETHER EXPRESS, IMPLIED, STATUTORY, OR OTHERWISE, INCLUDING FITNESS FOR A PARTICULAR PURPOSE OR USE, MERCHANTABILITY, PERFORMANCE, QUALITY OR NON-INFRINGEMENT OF ANY INTELLECTUAL PROPERTY RIGHT; ALL SUCH WARRANTIES ARE HEREBY EXPRESSLY DISCLAIMED. SKYWORKS DOES NOT WARRANT THE ACCURACY OR COMPLETENESS OF THE INFORMATION, TEXT, GRAPHICS OR OTHER ITEMS CONTAINED WITHIN THESE MATERIALS. SKYWORKS SHALL NOT BE LIABLE FOR ANY DAMAGES, INCLUDING BUT NOT LIMITED TO ANY SPECIAL, INDIRECT, INCIDENTAL, STATUTORY, OR CONSEQUENTIAL DAMAGES, INCLUDING WITHOUT LIMITATION, LOST REVENUES OR LOST PROFITS THAT MAY RESULT FROM THE USE OF THE MATERIALS OR INFORMATION, WHETHER OR NOT THE RECIPIENT OF MATERIALS HAS BEEN ADVISED OF THE POSSIBILITY OF SUCH DAMAGE.

Skyworks products are not intended for use in medical, lifesaving or life-sustaining applications, or other equipment in which the failure of the Skyworks products could lead to personal injury, death, physical or environmental damage. Skyworks customers using or selling Skyworks products for use in such applications do so at their own risk and agree to fully indemnify Skyworks for any damages resulting from such improper use or sale.

Customers are responsible for their products and applications using Skyworks products, which may deviate from published specifications as a result of design defects, errors, or operation of products outside of published parameters or design specifications. Customers should include design and operating safeguards to minimize these and other risks. Skyworks assumes no liability for applications assistance, customer product design, or damage to any equipment resulting from the use of Skyworks products outside of stated published specifications or parameters.

Skyworks and the Skyworks symbol are trademarks or registered trademarks of Skyworks Solutions, Inc. or its subsidiaries in the United States and other countries. Third-party brands and names are for identification purposes only, and are the property of their respective owners. Additional information, including relevant terms and conditions, posted at www.skyworksinc.com, are incorporated by reference.

Компания «Океан Электроники» предлагает заключение долгосрочных отношений при поставках импортных электронных компонентов на взаимовыгодных условиях!

Наши преимущества:

- Поставка оригинальных импортных электронных компонентов напрямую с производств Америки, Европы и Азии, а так же с крупнейших складов мира;
- Широкая линейка поставок активных и пассивных импортных электронных компонентов (более 30 млн. наименований);
- Поставка сложных, дефицитных, либо снятых с производства позиций;
- Оперативные сроки поставки под заказ (от 5 рабочих дней);
- Экспресс доставка в любую точку России;
- Помощь Конструкторского Отдела и консультации квалифицированных инженеров;
- Техническая поддержка проекта, помощь в подборе аналогов, поставка прототипов;
- Поставка электронных компонентов под контролем ВП;
- Система менеджмента качества сертифицирована по Международному стандарту ISO 9001;
- При необходимости вся продукция военного и аэрокосмического назначения проходит испытания и сертификацию в лаборатории (по согласованию с заказчиком);
- Поставка специализированных компонентов военного и аэрокосмического уровня качества (Xilinx, Altera, Analog Devices, Intersil, Interpoint, Microsemi, Actel, Aeroflex, Peregrine, VPT, Syfer, Eurofarad, Texas Instruments, MS Kennedy, Miteq, Cobham, E2V, MA-COM, Hittite, Mini-Circuits, General Dynamics и др.);

Компания «Океан Электроники» является официальным дистрибьютором и эксклюзивным представителем в России одного из крупнейших производителей разъемов военного и аэрокосмического назначения «JONHON», а так же официальным дистрибьютором и эксклюзивным представителем в России производителя высокотехнологичных и надежных решений для передачи СВЧ сигналов «FORSTAR».



JONHON

«JONHON» (основан в 1970 г.)

Разъемы специального, военного и аэрокосмического назначения:

(Применяются в военной, авиационной, аэрокосмической, морской, железнодорожной, горно- и нефтедобывающей отраслях промышленности)

«FORSTAR» (основан в 1998 г.)

ВЧ соединители, коаксиальные кабели, кабельные сборки и микроволновые компоненты:

(Применяются в телекоммуникациях гражданского и специального назначения, в средствах связи, РЛС, а так же военной, авиационной и аэрокосмической отраслях промышленности).



Телефон: 8 (812) 309-75-97 (многоканальный)

Факс: 8 (812) 320-03-32

Электронная почта: ocean@oceanchips.ru

Web: <http://oceanchips.ru/>

Адрес: 198099, г. Санкт-Петербург, ул. Калинина, д. 2, корп. 4, лит. А