

Safety Certified capacitors

Knowles Safety Certified capacitors comply with international UL and TÜV specifications to offer designers the option of using a surface mount ceramic multilayer capacitor to replace leaded film types. Offering the benefits of simple pick-and-place assembly, reduced board space required and lower profile, they are also available in a FlexiCap™ version to reduce the risk of mechanical cracking.

Knowles high voltage capacitor expertise means the range offers among the highest range available of capacitance values in certain case sizes. Applications include: modems, AC-DC power supplies and where lightning strike or other voltage transients represent a threat to electronic equipment.

Electrical Details		
Capacitance Range		4.7pF to 22nF
Temperature Coefficient of Capacitance (TCC)	COG/NPO	0 ± 30ppm/°C
	X7R	±15% from -55°C to +125°C
Dissipation Factor	COG/NPO	Cr > 50pF ≤ 0.0015
	X7R	Cr ≤ 50pF = 0.0015(15±Cr+0.7)
Insulation Resistance (IR)		100GΩ or 1000secs (whichever is the less)
Dielectric Withstand Voltage (DWW)		Voltage applied for 5 ± 1 seconds*, 50mA charging current maximum * - 60s for approval and AQL test
Ageing Rate	COG/NPO	Zero
	X7R	<2% per time decade

- Surface mount multilayer capacitors
- Meet Class Y2†/X1, X1 and X2 requirements
- Approved for mains ac voltages up to 250Vac
- Approved by UL and TÜV
- Sizes 1808, 1812, 2211, 2215 and 2220
- Smaller sizes suitable for use in equipment certified to EN60950
- Range qualified to AEC-Q200
- Certification specifications for larger sizes include IEC/ EN60384-14, UL/CSA60950 and UL60384-14
- Surface mount package
- Reduces board area and height restrictions
- Reduced assembly costs over conventional through hole components
- FlexiCap™ option available on all sizes

Class	Rated voltage	Impulse voltage	Insulation bridging	May be used in primary circuit
Y1	250Vac	8000V	Double or reinforced	Line to protective earth
Y2	250Vac	5000V	Basic or supplementary*	Line to protective earth
Y4	150Vac	2500V	Basic or supplementary*	Line to protective earth
X1	250Vac	4000V	-	Line to line
X2	250Vac	2500V	-	Line to line
X3	250Vac	None	-	Line to line

† Available for case sizes greater than 1812

* 2 x Y2 or Y4 rated may bridge double or reinforced insulation when used in series.

Dimensions

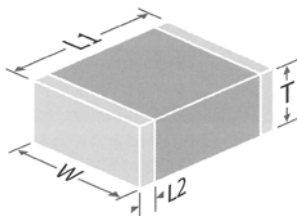

Size	Length (L1)	Width (W)	Max Thickness (T)	Band (L2)
1808	4.5 ± 0.35	2.0 ± 0.3	2.0	0.50 – 0.80
1812	4.5 ± 0.30	3.2 ± 0.2	3.2	0.50 – 0.80
2211	5.7 ± 0.40	2.79 ± 0.3	2.54	0.50 – 0.80
2215	5.7 ± 0.40	3.81 ± 0.35	2.54	0.50 – 0.80
2220 B16 / U16	5.7 ± 0.40	5.0 ± 0.4	4.5	0.25 – 1.0
2220 B17 / U17	5.7 ± 0.40	5.0 ± 0.4	2.5	0.25 -1.0

Classification and approval specification – Safety Certified capacitors

Chip size	Dielectric	Cap Range	Knowles Family Code	Classification	Approval Specification	Approval Body
1808	COG/NPO	4.7pF to 1.5nF	SP ⁽¹⁾	X2	IEC60384-14 EN60384-14	TÜV
				NWGQ2, NWGQ8	UL-60950-1, 2nd Ed CSA 60950-1-07 2nd Ed	UL
1808	X7R	150pF to 4.7nF	SP ⁽¹⁾	X2	IEC60384-14 EN60384-14	TÜV
				NWGQ2, NWGQ8	UL-60950-1, 2nd Ed CSA 60950-1-07 2nd Ed	UL
1808	COG/NPO	4.7pF to 390pF	PY2 ⁽¹⁾	X1	IEC60384-14 EN60384-14	TÜV
				NWGQ2, NWGQ8	UL-60950-1, 2nd Ed CSA 60950-1-07 2nd Ed	UL
1808	X7R	150pF to 1.0nF	PY2 ⁽¹⁾	X1	IEC60384-14 EN60384-14	TÜV
				NWGQ2, NWGQ8	UL-60950-1, 2nd Ed CSA 60950-1-07 2nd Ed	UL
1812	COG/NPO	4.7pF to 390pF	PY2 ⁽¹⁾	X1	IEC60384-14 EN60384-14	TÜV
		4.7pF to 470pF		NWGQ2, NWGQ8	UL-60950-1, 2nd Ed CSA 60950-1-07 2nd Ed	UL
1812	X7R	150pF to 2.2nF	PY2 ⁽¹⁾	X1	IEC60384-14 EN60384-14	TÜV
				NWGQ2, NWGQ8	UL-60950-1, 2nd Ed CSA 60950-1-07 2nd Ed	UL
2211	COG/NPO	4.7pF to 1nF	SP ⁽²⁾	Y2/X1	IEC60384-14 EN60384-14	TÜV
				NWGQ2, NWGQ8	UL-60950-1, 2nd Ed CSA 60950-1-07 2nd Ed	UL
2211	X7R	100pF to 3.9nF	SP ⁽²⁾	Y2/X1	IEC60384-14 EN60384-14	TÜV
				NWGQ2, NWGQ8	UL-60950-1, 2nd Ed CSA 60950-1-07 2nd Ed	UL
2215	COG/NPO	820pF to 1.0nF	SP ⁽²⁾	Y2/X1	IEC60384-14 EN60384-14	TÜV
				NWGQ2, NWGQ8	UL-60950-1, 2nd Ed CSA 60950-1-07 2nd Ed	UL
2215	X7R	2.7nF to 3.9nF	SP ⁽²⁾	Y2/X1	IEC60384-14 EN60384-14	TÜV
				NWGQ2, NWGQ8	UL-60950-1, 2nd Ed CSA 60950-1-07 2nd Ed	UL
2220	X7R	150pF to 10nF ⁽³⁾	B16	Y2/X1 ^{(2) (3)}	IEC60384-14 EN60384-14	TÜV
				Y2/X1, ⁽¹⁾ FOWX2, FOWX8	UL-60384-14 CSA E60384-14:09	UL
2220	X7R	150pF to 22nF	B17 ⁽²⁾	X2	IEC60384-14 EN60384	TÜV

Notes: Termination availability

(1) J & Y terminations only.

(2) J, Y, A & H terminations available.

(3) >5.6nF available with Y & H terminations only. Utilise StackiCap™ technology

PY2 Unmarked capacitors also available as released in accordance with approval specifications with additional 2.5kVdc rating. Family codes SY2 applies.

SP Unmarked capacitors also available as released in accordance with approval specifications with additional 2.5kVdc rating. Family codes SYU applies.

B16 Also available as released in accordance with approval specifications with additional 2.5kVdc rating. Family codes U16 applies.

B17 Also available as released in accordance with approval specifications with additional 2.5kVdc rating. Family codes U17 applies.

	COG/NPO			X7R		
	Ultra stable			Stable		
IECQ-CECC	1B/CG	-	-	2C1	2R1	2X1
EIA	-	COG/NPO	-	-	X7R	-
MIL	-	-	CG (BP)	BZ	-	BX
Rated temperature range	-55°C to +125°C			-55°C to +125°C		
Maximum capacitance change over temperature range	0 ± 30 ppm/°C			± 20%	± 15%	± 15%
Rated DC voltage applied				+20 -30%	-	+15 -25%
Knowles / Syfer dielectric ordering code	C			R	X	B
Tangent of loss angle (tan δ)	Cr > 50pF ≤ 0.0015 Cr ≤ 50pF = 0.0015 (15 + 0.7) Cr			≤ 0.025		
Insulation resistance (Ri) OR Time constant (Ri*Cr) (whichever is the least)	100G Ω or 1000s			100G Ω or 1000s		
Capacitance tolerance (ordering code)	Cr < 4.7pF	± 0.05pF (H) ± 0.10pF (B) ± 0.25pF (C) ± 0.50pF (D)		± 5% (J) ± 10% (K) ± 20% (M)		
	Cr < 10pF	± 0.10pF (B) ± 0.25pF (C) ± 0.50pF (D)				
	Cr ≥ 10pF	± 1% (F) ± 2% (G) ± 5% (J) ± 10% (K)				
Dielectric strength	100% dc Test Voltage applied for 5 seconds max. Product approval and AQL Test – voltage applied for 60s Charging current limited to 50mA maximum (dc test).					
1808 SP	100% DWV Test: 3000Vdc 1s min / 5s max AQL DWV Test: 2500Vdc / 1500Vac 60s min all batches					
1808 / 1812 PY2	100% Test: 3000Vdc 1s min / 5s max AQL Test: 3000Vdc / 2000Vac 60s min all batches					
2211 / 2215 SP	100% Test: 3000Vdc 1s min / 5s max AQL Test: 3000Vdc / 2000Vac 60s min all batches					
2220 B16 / B17	100% Test: 3000Vdc 1s min / 5s max AQL Test: 3000Vdc / 2000Vac 60s min all batches					
Impulse Test 1.2x50µs AQL all batches	Classification Y2 – 5000V Classification X1 – 4000V Classification X2 – 2500V					
Climatic category (IEC)	55/125/56			55/125/56		
Ageing characteristic (Typical)	Zero			<2% per time decade		

Ordering Information – Safety Certified capacitors – Class SPU/SP ranges

1808	J	A25	0102	J	C	T	SP
Chip Size	Termination	Rated Voltage	Capacitance in Pico farads (pF)	Capacitance Tolerance	Dielectric Codes	Packaging	Suffix code
1808 2211 2215	<p>J = nickel barrier (100% matte tin plating). RoHS compliant</p> <p>Y = FlexiCap™ termination base with Ni barrier (100% matte tin plating). RoHS compliant. 2211/2215 only</p> <p>A = Ni barrier (Tin/lead plating with min. 10% lead). Not RoHS compliant.</p> <p>H = FlexiCap™ termination base with Ni barrier (Tin/lead plating with min. 10% lead). Not RoHS compliant.</p>	A25 = 250Vac (SPU = 250Vac / 2500Vdc)	<p>First digit is 0.</p> <p>Second and third digits are significant figures of capacitance code.</p> <p>The fourth digit is number of zeros following.</p> <p>Example: 0102 = 1.0nF</p>	<p><10pF</p> <p>B = ±0.10pF</p> <p>C = ±0.25pF</p> <p>D = ±0.50pF</p> <p>≥ 10pF</p> <p>F = ±1%</p> <p>G = ±2%</p> <p>J = ±5%</p> <p>K = ±10%</p> <p>M = ±20%</p>	<p>C = COG/NP0</p> <p>X = X7R</p> <p>A = COG/NP0 AEC-Q200</p> <p>E = X7R (2B1) AEC-Q200</p>	<p>T = 178mm (7") reel</p> <p>R = 330mm (13") reel</p> <p>B = Bulk pack – tubs or trays</p>	<p>SP = Surge Protection capacitors (marked and approved)</p> <p>SPU = Surge Protection capacitors (un-marked parts are in accordance with, but not certified)</p>

Ordering Information – Safety Certified capacitors – Class PY2/SY2

1808	J	A25	0102	J	X	T	PY2
Chip Size	Termination	Rated Voltage	Capacitance in Pico farads (pF)	Capacitance Tolerance	Dielectric Codes	Packaging	Suffix code
1808 1812	<p>J = nickel barrier (100% matte tin plating). RoHS compliant</p> <p>Y = FlexiCap™ termination base with Ni barrier (100% matte tin plating). RoHS compliant.</p>	A25 = 250Vac (SY2 = 250Vac / 2500Vdc)	<p>First digit is 0.</p> <p>Second and third digits are significant figures of capacitance code.</p> <p>The fourth digit is number of zeros following.</p> <p>Example: 0102 = 1.0nF</p>	<p><10pF</p> <p>B = ±0.10pF</p> <p>C = ±0.25pF</p> <p>D = ±0.50pF</p> <p>≥ 10pF</p> <p>F = ±1%</p> <p>G = ±2%</p> <p>J = ±5%</p> <p>K = ±10%</p> <p>M = ±20%</p>	<p>C = COG/NP0</p> <p>X = X7R</p> <p>A = COG/NP0 AEC-Q200</p> <p>E = X7R (2B1) AEC-Q200</p>	<p>T = 178mm (7") reel</p> <p>R = 330mm (13") reel</p> <p>B = Bulk pack – tubs or trays</p>	<p>PY2 = Safety tested Surge Protection capacitors (marked and approved)</p> <p>SY2 = Surge Protection capacitors (un-marked parts are in accordance with, but not certified)</p>

Ordering Information – Safety Certified capacitors – Class B16/B17 ranges

2220	J	A25	0102	J	X	T	B16
Chip Size	Termination	Rated Voltage	Capacitance in Pico farads (pF)	Capacitance Tolerance	Dielectric Codes	Packaging	Suffix code
2220	<p>J = nickel barrier (100% matte tin plating). RoHS compliant</p> <p>Y = FlexiCap™ termination base with Ni barrier (100% matte tin plating). RoHS compliant.</p> <p>A = Ni barrier (Tin/lead plating with min. 10% lead). Not RoHS compliant.</p> <p>H = FlexiCap™ termination base with Ni barrier (Tin/lead plating with min. 10% lead). Not RoHS compliant.</p>	<p>A25 = 250Vac (U16 = 250Vac / 2500Vdc)</p> <p>(U17 = 250Vac / 2500Vdc)</p>	<p>First digit is 0.</p> <p>Second and third digits are significant figures of capacitance code.</p> <p>The fourth digit is number of zeros following.</p> <p>Example: 0102 = 1.0nF</p>	<p>J = ±5%</p> <p>K = ±10%</p> <p>M = ±20%</p>	<p>X = X7R</p> <p>E = X7R (2B1) AEC-Q200</p> <p>J = X7R (BME)⁽⁴⁾</p>	<p>T = 178mm (7") reel</p> <p>R = 330mm (13") reel</p> <p>B = Bulk pack – tubs or trays</p>	<p>B16 = Type A: X1/Y2</p> <p>B17 = Type B: X2</p> <p>U16 = Type A: (In accordance with, but not certified to, class X1/Y2)</p> <p>U17 = Type B: (In accordance with, but not certified to, class X2)</p>

Dielectric code E (AEC-Q200 approved X7R Dielectric) available with terminations Y & H only

(4) 'J' dielectric code for B16 values ≤4.7nF only.

Soldering Information

Knowles / Syfer MLCCs are compatible with all recognised soldering/mounting methods for chip capacitors. A detailed application note is available at www.knowlescapacitors.com/syfer

Reflow Soldering

Knowles recommend reflow soldering as the preferred method for mounting MLCCs. Knowles MLCCs can be reflow soldered using a reflow profile generally defined in IPC/FEDEC J-STD-020. Sn plated termination chip capacitors are compatible with both conventional and lead free soldering with peak temperatures of 260° to 270°C acceptable.

The heating ramp rate should be such that components see a temperature rise of 1.5° to 4°C per second to maintain temperature uniformity through the MLCC.

The time for which the solder is molten should be maintained at a minimum, so as to prevent solder leaching. Extended times above 230°C can cause problems with oxidation of Sn plating. Use of an inert atmosphere can help if this problem is encountered. Palladium/Silver (Pd/Ag) terminations can be particularly susceptible to leaching with free lead, tin rich solders and trials are recommended for this combination.

Cooling to ambient temperature should be allowed to occur naturally, particularly if larger chip sizes are being soldered. Natural cooling allows a gradual relaxation of thermal mismatch stresses in the solder joints. Forced cooling should be avoided as this can induce thermal breakage.

Wave Soldering

Wave soldering is generally acceptable, but the thermal stresses caused by the wave have been shown to lead to potential problems with larger or thicker chips. Particular care should be taken when soldering SM chips larger than size 1210 and with a thickness greater than 1.0mm for this reason.

Maximum permissible wave temperature is 270°C for SM chips.

The total immersion time in solder should be kept to a minimum. It is strongly recommended that Sn/Ni plated terminations are specified for wave soldering applications.

Solder Leaching

Leaching is the term for the dissolution of silver in the solder causing a failure of the termination system which causes increased ESR, $\tan \delta$ and open circuit faults, including ultimately the possibility of the chip becoming detached.

Leaching occurs more readily with higher temperature solders and solders with a high tin content. Pb free solders can be very prone to leaching certain termination systems. To prevent leaching, exercise care when choosing solder allows and minimize both maximum temperature and dwell time with the molten solder.

Plated terminations with nickel or copper anti-leaching barrier layers are available in a range of top coat finishes to prevent leaching occurring. These finishes also include Knowles FlexiCap™ for improved stress resistance post soldering.

Multilayer ceramic chip with nickel or copper barrier termination



Rework of Chip Capacitors

Knowles recommend hot air/gas as the preferred method of applying heat for rework. Apply even heat surrounding the component to minimise internal thermal gradients. Soldering irons or other techniques that apply direct heat to the chip or surrounding area, should not be used as these can result in micro cracks being generated.

Minimise the rework heat duration and allow components to cool naturally after soldering.

Use of Silver Loaded Epoxy Adhesives

Chip capacitors can be mounted to circuit boards using silver loaded adhesive provided the termination material of the capacitor is selected to be compatible with the adhesive. This is normally PdAg. Standard tin finishes are often not recommended for use with silver loaded epoxies as there can be electrical and mechanical issues with the joint integrity due to material mismatch.

Handling & Storage

Components should never be handled with fingers; perspiration and skin oils can inhibit solderability and will aggravate cleaning.

Chip capacitors should never be handled with metallic instruments. Metal tweezers should never be used as these can chip the product and leave abraded metal tracks on the product surface. Plastic or plastic coated metal types are readily available and recommended – these should be used with an absolute minimum of applied pressure.

Incorrect storage can lead to problems for the user. Rapid tarnishing of the terminations, with an associated degradation of solderability, will occur if the product comes into contact with industrial gases such as sulphur dioxide and chlorine. Storage in free air, particularly moist or polluted air, can result in termination oxidation.

Packaging should not be opened until the MLCs are required for use. If opened, the pack should be re-sealed as soon as practicable. Alternatively, the contents could be kept in a sealed container with an environmental control agent.

Long term storage conditions, ideally, should be temperature controlled between -5° and +40°C and humidity controlled between 40 and 60% R.H.

Taped product should be stored out of direct sunlight, which might promote deterioration in tape or adhesive performance.

Product, store under the conditions recommended above, in its "as received" packaging, has a minimum shelf life of 2 years.

SM Pad Design

Knowles conventional 2-terminal chip capacitors can generally be mounted using pad designs in accordance with IPC-7351, Generic Requirements for Surface Mount Design and Land Pattern Standards, but there are some other factors that have been shown to reduce mechanical stress, such as reducing the pad width to less than the chip width. In addition, the position of the chip on the board should also be considered.

3-terminal components are not specifically covered by IPC-7351, but recommended pad dimensions are included in the Knowles catalogue/website for these components.

FlexiCap™ Termination

FlexiCap™ has been developed as a result of listening to customer's experiences of stress damage to MLCCs from many manufacturers, often caused by variations in production processes.

Our answer is a proprietary flexible epoxy polymer termination material that is applied to the device under the usual nickel barrier finish. FlexiCap™ will accommodate a greater degree of board bending than conventional capacitors.

Ranges are available with FlexiCap™ termination material offering increased reliability and superior mechanical performance (board flex and temperature cycling) when compared with standard termination materials. Refer to Knowles application note reference AN0001. FlexiCap™ capacitors enable the board to be bent almost twice as much as before mechanical cracking occurs. Refer to application note AN0002.

FlexiCap™ is also suitable for space applications having passed thermal vacuum outgassing tests. Refer to Knowles application note reference AN0026.

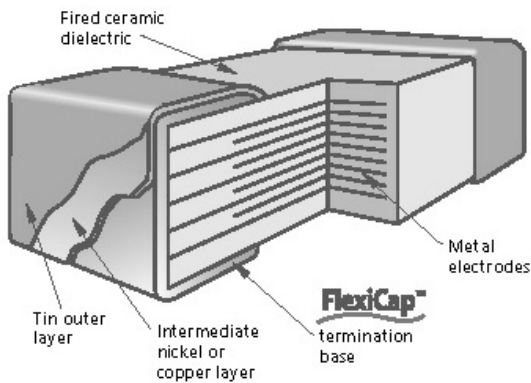

FlexiCap™ MLCC cross section

Knowles has delivered millions of FlexiCap™ components and during that time has collected substantial test and reliability data, working in partnership with customers world wide, to eliminate mechanical cracking.

An additional benefit of FlexiCap™ is that MLCCs can withstand temperature cycling from -55 to 125°C in excess of 1,000 times without cracking.

FlexiCap™ termination has no adverse effect on any electrical parameters, nor affects the operation of the MLCC in any way.

Application Notes

FlexiCap™ may be handled, stored and transported in the same manner as standard terminated capacitors. The requirements for mounting and soldering FlexiCap™ are the same as for standard SMD capacitors.

For customers currently using standard terminated capacitors there should be requirement to change the assembly process when converting to FlexiCap™.

Based upon the board bend tests in accordance with IEC 60384-1 the amount of board bending required to mechanically crack a FlexiCap™ terminated capacitor is significantly increased compared with standard terminated capacitors.

Product: X7R	Typical bend performance under AEC-Q200 test conditions
Standard Termination	2mm to 3mm
FlexiCap™	Typically 8mm to 10mm

REACH (Registration, Evaluation, Authorisation and restriction of Chemicals) Statement

The main purpose of REACH is to improve the protection of human health and the environment from the risks arising from the use of chemicals.

Knowles monitors the REACH legislation to ensure compliance. All products made by Knowles are 'articles' under the definition of REACH and a certificate of compliance is maintained on our website www.knowlescapacitors.com/syfer.

For further information, please contact the sales office at SyferSales@knowles.com

RoHS Compliance

Knowles routinely monitors world wide material restrictions (e.g., EU/China and Korea RoHS mandates) and is actively involved in shaping future legislation.

All standard COG/NPO, X7R, X5R and High Q Knowles MLCC products are compliant with the EU RoHS directive (see below for special exemptions) and those with plated terminations are suitable for soldering common lead free solder alloys (refer to 'Soldering Information' for more details on soldering limitations). Compliance with EU RoHS directive automatically signifies compliance with some other legislation (e.g., Korea RoHS). Please refer to the Sales Office for details of compliance with other materials legislation.

Breakdown of material content, SGS analysis reports and tin whisker test results are available on request.

Most Knowles MLCC components are available with non-RoHS compliant tin/lead (SnPb) Solderable termination finish for exempt applications and where pure tin is not acceptable. Other tin free termination finishes may also be available – please refer to the Sales Office for further details.

X8R ranges <250Vdc are not RoHS 2011/65/EU compliant.

Check the website, www.knowlescapacitors.com/syfer for latest RoHS update.

Export Controls and Dual-use Regulations

Certain Knowles catalogue components are defined as 'dual-use' items under international export controls – those that can be used for civil and military purposes which meet certain specified technical standards.

The defining criteria for a dual-use component with respect to Knowles products is one with a voltage rating of >750V and a capacitance value >250nF and a series inductance <10nH.

Components defined as 'dual-use' under the above criteria automatically require a licence for export outside the EU, and may require a licence for export with the EU.

The application for a licence is routine, but customers for these products will be asked to supply further information.

Please refer to the sales office if you require any further information on export restrictions.

Other special components may additionally need to comply with export regulations.

Ageing of Ceramic Capacitors

Capacitor ageing is a term used to describe the negative, logarithmic capacitance change which takes place in ceramic capacitors with time. The crystalline structure for barium titanate based ceramics changes on passing through its Curie temperature (known as the Curie Point) at about 125°C. The domain structure relaxes with time and in doing so, the dielectric constant reduces logarithmically; this is known as the ageing mechanism of the dielectric constant. The more stable dielectrics have the lowest ageing rates.

The ageing process is reversible and repeatable. Whenever the capacitor is heated to a temperature above the Curie Point the ageing process starts again from zero.

The ageing constant, or ageing rate, is defined as the percentage loss of capacitance due to the ageing process of the dielectric which occurs during a decade of time (a tenfold increase in age) and is expressed as percent per logarithmic decade of hours. As the law of decrease of capacitance is logarithmic, this means that for a capacitor with an ageing rate of 1% per decade of time, the capacitance will decrease at a rate of:

- 1% between 1 and 10 hours
- An additional 1% between the following 10 and 100 hours
- An additional 1% between the following 100 and 1000 hours
- An additional 1% between the following 1000 and 10000 hours
- The ageing rate continues in this manner throughout the capacitor's life.

Typical values of the ageing constant for our MLCCs are

Dielectric Class	Typical Values
Ultra Stable COG/NPO	Negligible capacitance loss through ageing
Stable X7R	<2% per decade of time

Capacitance Measurements

Because of ageing it is necessary to specify an age for reference measurements at which the capacitance shall be within the prescribed tolerance. This is fixed at 1000 hours, since for all practical purposes there is not much further loss of capacitance after this time.

All capacitors shipped are within their specified tolerance at the standard reference age of 1000 hours after having cooled through their Curie temperature.

The ageing curve for any ceramic dielectric is a straight line when plotted on semi-log paper.

Capacitance vs. Time

(Ageing X7R @ 1% per decade)

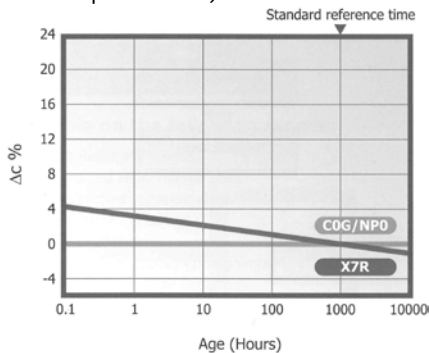

Tight Tolerance

One of the advantages of Knowles's unique 'wet process' of manufacture is the ability to offer capacitors with exceptionally tight capacitance tolerances.

The accuracy of the printing screens used in the fully automated, computer controlled manufacturing process allows for tolerance as close as ± 1% on COG/NPO parts greater than or equal to 10pF. For capacitance value less than 4.7pF tolerances can be as tight as ± 0.05pF.

Periodic Tests Conducted and Reliability Data

For standard surface mount capacitors components are randomly selected on a sample basis and the following routine tests conducted:

- Load Test. 1,000 hours @ 125°C (150°C for X8R). Applied voltage depends on components tested
- Humidity Test. 168 hours @ 85°C/85%RH
- Board Deflection (bend test)

Test results are available on request.

Conversion Factors

From	To	Operation
FITs	MTBF (hours)	$10^9 \div \text{FITs}$
FITs	MTBF (years)	$10^9 \div (\text{FITs} \times 8760)$

FIT = Failures In Time. 1 FIT = 1 failure in 10^9 hours

MTBF = Mean Time Between Failure

Example of FIT Data Available



Component type: 0805 (COG/NPO and X7R)

Testing Location: Knowles reliability test department

Results based on: 16,622,000 component test hours

Packaging Information

Tape and reel packing of surface mounting chip capacitors for



automatic placement are in accordance with IEC60286-3.

Peel Force

The peel force of the top sealing tape is between 0.2 and 1.0 Newton at 180°. The breaking force of the carrier and sealing tape in the direction of unreeling is greater than 10 Newton.

Reel Dimensions



Symbol	Description	178mm Reel	330mm Reel
A	Reel diameter	178 (7)	330 (13)
G	Reel inside width	8.4 (0.33)	12.4 (0.49)
T	Reel outside width	14.4 (0.56) max	18.4 (0.72) max

Tape Dimensions



Symbol	Description	Dimensions mm (inches)	
		8mm Tape	12mm Tape
A ₀	Width of cavity	Dependent on chip size to minimize rotation	
B ₀	Length of cavity		
K ₀	Depth of cavity		
W	Width of tape	8.0 (0.315)	12.0 (0.472)
F	Distance between drive hole centres and cavity centres	3.5 (0.138)	5.5 (0.213)
E	Distance between drive hole centres and tape edge	1.75 (0.069)	
P ₁	Distance between cavity centres	4.0 (0.156)	8.0 (0.315)
P ₂	Axial distance between drive hole centres and cavity centres	2.0 (0.079)	
P ₀	Axial distance between drive hole centres	4.0 (0.156)	
D ₀	Drive hole diameter	1.5 (0.059)	
D ₁	Diameter of cavity piercing	1.0 (0.039)	1.5 (0.059)
T	Carrier tape thickness	0.3 (0.012) ±0.1 (0.04)	0.4 (0.016) ±0.1 (0.04)
t ₁	Top tape thickness	0.1 (0.004) max	

Packing Information

Missing Components

The number of missing components in the tape may not exceed 0.25% of the total quantity with not more than three consecutive components missing. This must be followed by at least six properly placed components

Identification

Each reel is labelled with the following information: manufacturer, chip size, capacitance, tolerance, rated voltage, dielectric type, batch number, date code and quantity of components.

Component Orientation

Tape and reeling is in accordance with IEC 60286 part 3, which defines the packaging specifications for leadless components on continuous tapes.

- Notes:
- 1) IEC60286-3 states A0 < B0
 - 2) Regarding the orientation of 1825 and 2225 components, the termination bands are right to left, NOT front to back. Please see diagram.

Leader Trailer

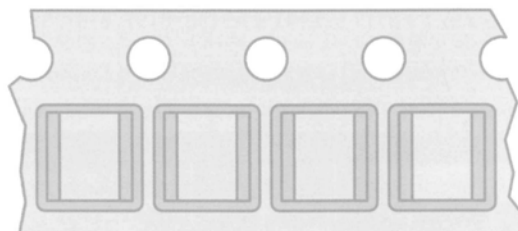
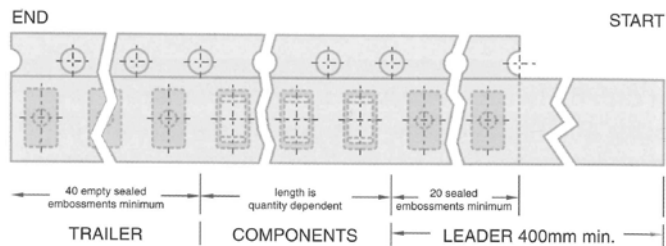

Orientation of 1825 & 2225 components

Outer Packaging

Outer carton dimensions mm (inches) max

Reel Size	No. of Reels	L	W	T
178 (7)	1	185 (7.28)	185 (7.28)	25 (0.98)
178 (7)	4	190 (7.48)	195 (7.76)	75 (2.95)
330 (13)	1	335 (13.19)	335 (13.19)	25 (0.98)

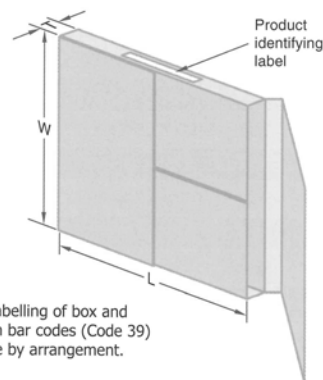

Reel Quantities

Chip Size	1808	1812	2211	2215	2220 B16	2220 B17
	Max. Chip Thickness	2.0mm 0.08"	2.5mm 0.1"	2.5mm 0.1"	2.5mm 0.1"	4.5mm 0.18"
Reel Quantities	178mm (7")	1500	500	750	500	500
	330mm (13")	6000	2000	4000	4000	2000

Bulk Packing – Tubs

Chips are supplied in rigid re-sealable plastic tubs together with impact cushioning wadding. Tubs are labelled with the details: chip size, capacitance, tolerance, rated voltage, dielectric type, batch number, date code and quantity of components.

Dimensions mm (inches)

H	60mm (2.36")
D	50mm (1.97")

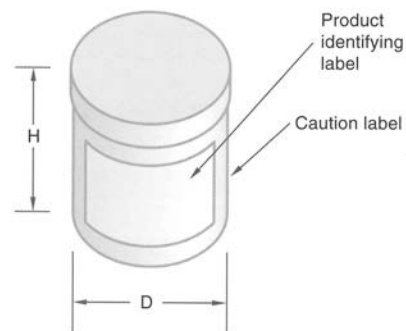

Компания «Океан Электроники» предлагает заключение долгосрочных отношений при поставках импортных электронных компонентов на взаимовыгодных условиях!

Наши преимущества:

- Поставка оригинальных импортных электронных компонентов напрямую с производств Америки, Европы и Азии, а так же с крупнейших складов мира;
- Широкая линейка поставок активных и пассивных импортных электронных компонентов (более 30 млн. наименований);
- Поставка сложных, дефицитных, либо снятых с производства позиций;
- Оперативные сроки поставки под заказ (от 5 рабочих дней);
- Экспресс доставка в любую точку России;
- Помощь Конструкторского Отдела и консультации квалифицированных инженеров;
- Техническая поддержка проекта, помощь в подборе аналогов, поставка прототипов;
- Поставка электронных компонентов под контролем ВП;
- Система менеджмента качества сертифицирована по Международному стандарту ISO 9001;
- При необходимости вся продукция военного и аэрокосмического назначения проходит испытания и сертификацию в лаборатории (по согласованию с заказчиком);
- Поставка специализированных компонентов военного и аэрокосмического уровня качества (Xilinx, Altera, Analog Devices, Intersil, Interpoint, Microsemi, Actel, Aeroflex, Peregrine, VPT, Syfer, Eurofarad, Texas Instruments, MS Kennedy, Miteq, Cobham, E2V, MA-COM, Hittite, Mini-Circuits, General Dynamics и др.);

Компания «Океан Электроники» является официальным дистрибьютором и эксклюзивным представителем в России одного из крупнейших производителей разъемов военного и аэрокосмического назначения «JONHON», а так же официальным дистрибьютором и эксклюзивным представителем в России производителя высокотехнологичных и надежных решений для передачи СВЧ сигналов «FORSTAR».



JONHON

«JONHON» (основан в 1970 г.)

Разъемы специального, военного и аэрокосмического назначения:

(Применяются в военной, авиационной, аэрокосмической, морской, железнодорожной, горно- и нефтедобывающей отраслях промышленности)

«FORSTAR» (основан в 1998 г.)

ВЧ соединители, коаксиальные кабели, кабельные сборки и микроволновые компоненты:

(Применяются в телекоммуникациях гражданского и специального назначения, в средствах связи, РЛС, а так же военной, авиационной и аэрокосмической отраслях промышленности).



Телефон: 8 (812) 309-75-97 (многоканальный)

Факс: 8 (812) 320-03-32

Электронная почта: ocean@oceanchips.ru

Web: <http://oceanchips.ru/>

Адрес: 198099, г. Санкт-Петербург, ул. Калинина, д. 2, корп. 4, лит. А