

## Single phase - general purpose

Comprehensive family of single and multi-stage chassis mount filters. Throughout the power range, a high level of performance is provided within various sizes and styles of metal enclosure and termination options.

Designed to provide economic solutions to a multitude of general purpose filtering requirements; industrial power equipment, office, business and medical equipments.

The two stage FAS series is specifically designed to suppress RFI generated by switch mode power supply applications.

- Current ratings from 0.5A to 40A
- High symmetric and asymmetric attenuation
- Earth line choke and medical versions available
- Custom designs to client specifications

## Mechanical Specifications

Manufacture: metal case and cover, internal components sealed with self-extinguishing resin.

Connections: faston 6.3 x 0.8mm ( $\leq 16A$ ), flexible leads, screws M4 ( $\leq 40A$ ) ground terminal connected to case.

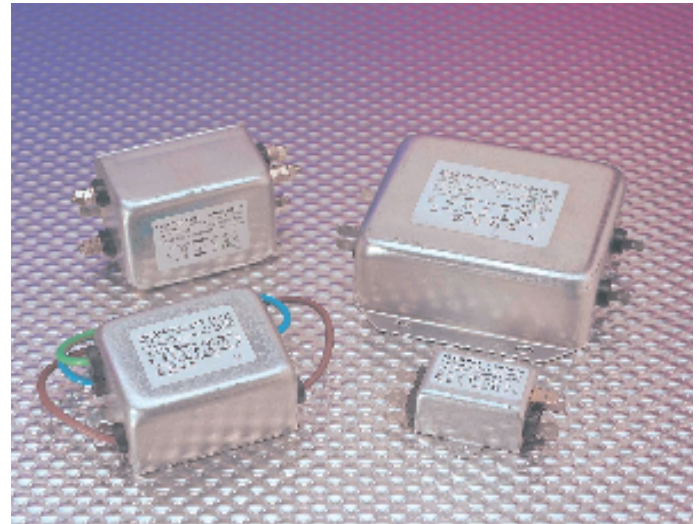

## Electrical Specifications

Rated voltage ( $V_R$ ): max 250V, 50/60Hz

Rated current ( $I_R$ ): referred to room temperature = 40°C

Leakage current ( $I_L$ ): at 220V, 50Hz, max value

Voltage test (2 s.): line to ground 3000Vdc or 1800Vac  
line to line 1700Vdc

Climatic category: HPF (25/085/21);

Temperature range: -25°C to +85°C

## Dimensions (mm)

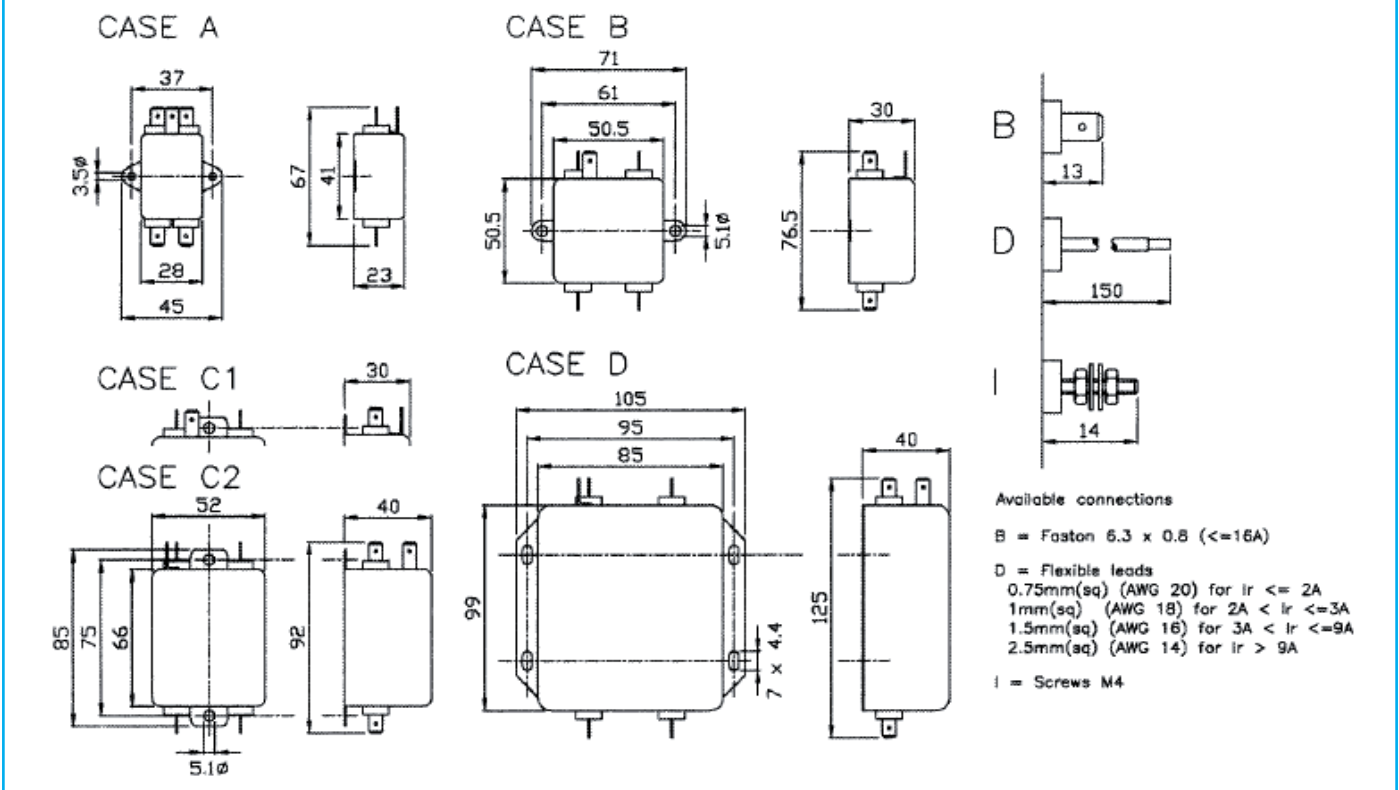

## Filter Range

FAI Code	I <sub>R</sub> (A)	L (mH)	C <sub>x</sub> (μF)	C <sub>y</sub> (pF)	I <sub>L</sub> (mA)	R (MΩ)	Circ Diag	Case
FAIDB2150ZA	1.5	2x10	0.015	2x2200	2x0.2		A	A
FAIDB2150ZB	1	2x10	0.015	2x2200	2x0.2		A	A
FAIDB2150ZC	3	2x2	0.015	2x2200	2x0.2		A	A
FAIDB2150ZD	6.5	2x1	0.015	2x2200	2x0.2		A	A
FAID-2330ZA	10	2x0.5	0.033	2x2200	2x0.2	1	B	B
FAID-2330ZB	20	2x0.5	0.033	2x2200	2x0.2	1	B	B
FAID-2330ZC	30	2x0.6	0.033	2x2200	2x0.2	1	B	D
FAID-3100ZA	5	2x1	0.1	2x3200	2x0.29	1	B	B
FAID-3100ZB	5	2x1.7	0.1	2x3200	2x0.29	1	B	B



 B = Faston 6.3x0.8mm  
 D = Flexible leads  
 I = Screw M4

\* other variants on request

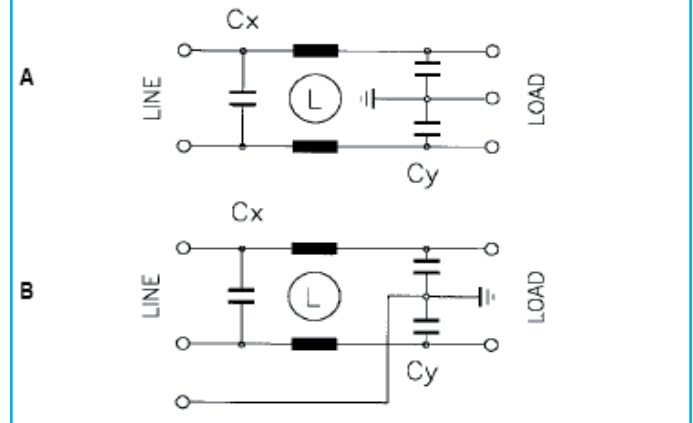
### Circuit diagram



FAK Code	I <sub>R</sub> (A)	L <sub>1</sub> (mH)	L <sub>2</sub> (mH)	C <sub>x1</sub> (μF)	C <sub>x2</sub> (μF)	C <sub>x3</sub> (μF)	C <sub>y1</sub> (pF)	C <sub>y2</sub> (pF)	I <sub>L</sub> (mA)	R (MΩ)	Circ Diag	Case
FAKD-3300ZA	3	2x2	2x2	0.15	0.15		2x2200		2x0.2	1	E	C1
FAKD-3300ZB	6	2x1	2x1	0.15	0.15		2x2200		2x0.2	1	E	C1
FAKD-3300ZC	10	2x0.5	2x0.5	0.15	0.15		2x2200		2x0.2	1	E	C2
FAKD-3300ZD	20	2x0.5	2x0.5	0.15	0.15		2x2200		2x0.2	1	E	D
FAKD-3570ZA	2.5	2x1	2x2.5		0.47	0.1	2x3300	2x3300	2x0.6	0.68	E	D
FAKD-3810ZA	10	2x2.3	2x2.3	0.27	0.27	0.27	2x5500	2x1000	2x0.6	0.33	E	D
FAKD-3940ZA	3	2x4.7	2x4.7	0.47	0.47		2x4700		2x0.5	0.24	F	C2

 B = Faston 6.3x0.8mm  
 D = Flexible leads  
 I = Screw M4

VDE 60939-2  
 ■ UL approval only

\* other variants on request

### Circuit diagram

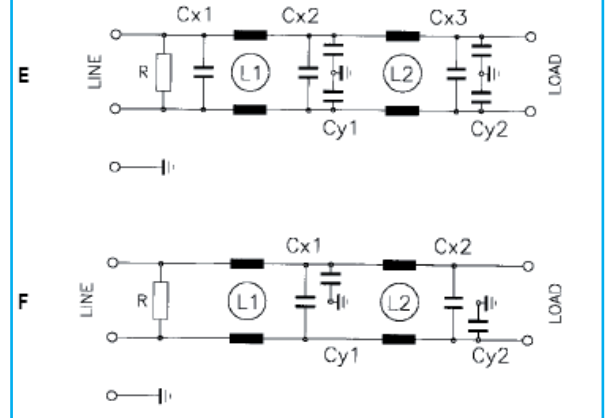

FAM Code	I <sub>R</sub> (A)	L (mH)	C <sub>x1</sub> (μF)	C <sub>x2</sub> (μF)	C <sub>y</sub> (pF)	I <sub>L</sub> (mA)	R (MΩ)	Circ Diag	Case
FAMD-3200ZA	1	2x40	0.1	0.1	2x4700	2x0.43	0.68	C	B
FAMD-3200ZB	5	2x1	0.1	0.1	2x3200	2x0.29	0.68	C	B
FAMD-3200ZC	10	2x0.5	0.1	0.1	2x2200	2x0.20	0.68	C	B
FAMD-3200ZD	20	2x0.5	0.1	0.1	2x2200	2x0.20	0.68	C	C2
FAMD-3200ZE	30	2x0.6	0.1	0.1	2x2200	2x0.20	0.68	C	D
▲ FAMD-3440ZA	10	2x1	0.22	0.22	2x4700	2x0.43	0.47	D	B
FAMD-3470ZA	6.5	2x4		0.47	2x1000	2x0.09	0.68	C	C2
FAMD-3600ZC	16	2x1		0.6	2x2500	2x0.23	0.47	C	C2
FAMD-3600ZD	22	2x0.2		0.6	2x2500	2x0.23	0.47	C	C2
▲ FAMD-3600ZE	20	2x1		0.6	2x4700	2x0.43	0.47	D	C2
▲ FAMD-3600ZF	40	2x0.23		0.6	2x4700	2x0.43	0.47	D	C2
▲ FAMD-3600ZH	30	2x0.23		0.6	2x4700	2x0.43	0.47	D	C2
▲ FAMD-3600ZK	25	2x0.5	0.6		2x4700	2x0.43	0.47	D	C2
▲ FAMD-3600ZL	25	2x0.5	0.6		2x22000	2x2.0	0.47	D	C2
FAMD-3940ZA	4.5	2x20	0.47	0.47	2x10000	2x0.91	0.33	C	C2
FAMD-3940ZB	3.3	2x13	0.47	0.47	2x6800	2x0.62	0.33	C	C2
■ FAMD-4100ZB	16	2x0.5		1.0	2x2500	2x0.23	0.33	D	C2
▲ FAMD-4160ZA	25	2x0.5	1.0	0.68	2x22000	2x2.0	0.47	C	C2

 B = Faston 6.3x0.8mm  
 D = Flexible leads  
 I = Screw M4

▲ VDE 60939-2 only  
 ■ UL approval only

\* other variants on request

### Circuit diagram

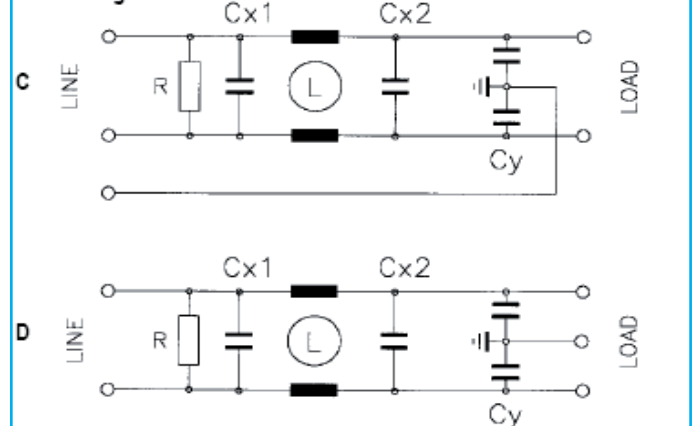

## Filter Range

FAR Code	I <sub>r</sub> (A)	L <sub>1</sub> (mH)	L <sub>2</sub> (mH)	C <sub>x1</sub> (μF)	C <sub>x2</sub> (μF)	C <sub>y1</sub> (pF)	C <sub>y2</sub> (pF)	I <sub>L</sub> (mA)	R (MΩ)	Circ Diag	Case
FARD-3620ZA	1.5	2x7	2x7	0.47	0.15		2x2200	2x0.2	0.47	G	C2
FARD-3620ZB	2.5	2x12	2x2	0.47	0.15		2x2200	2x0.2	0.47	G	C2
FARD-3620ZC	5	2x7	2x7	0.47	0.15		2x2200	2x0.2	0.47	G	C2
FARD-3620ZD	8.5	2x10	2x3	0.47	0.15		2x2200	2x0.2	0.47	G	D
▲ FARD-3940ZA	0.5	2x40	2x40	0.47	0.47		2x3300		2x0.3	G	C1

 B = Faston 6.3x0.8mm      ▲ VDE 60939-2 only  
 D = Flexible leads  
 I = Screw M4

\* other variants on request

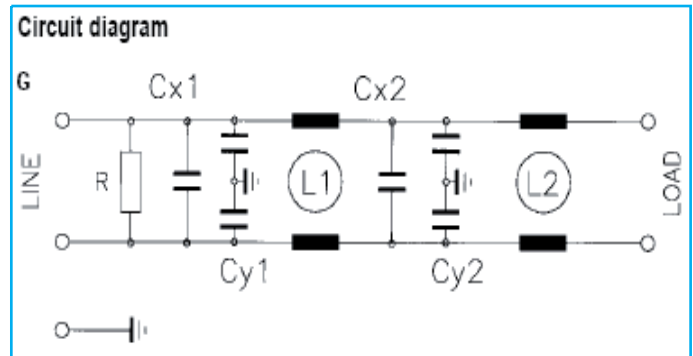

FAS Code	I <sub>r</sub> (A)	L <sub>1</sub> (mH)	L <sub>2</sub> (mH)	C <sub>x1</sub> (μF)	C <sub>y</sub> (pF)	I <sub>L</sub> (mA)	R (MΩ)	Circ Diag	Case
FASD-3220ZA	1	2x22	2x0.3	0.22	2x4700	2x0.43	1	H	B
FASD-3220ZB	2.5	2x16	2x0.3	0.22	2x4700	2x0.43	1	H	C2
FASD-3470ZA	6.5	2x4	2x0.05	0.47	2x22000	2x2	0.47	H	D
FASD-3470ZB	10	2x4	2x0.05	0.47	2x22000	2x2	0.47	H	D
FASD-3940ZA	4	2x8	2x0.05	0.94	2x22000	2x2	0.33	H	C2
▲ FASD-3940ZC	10	2x4	2x0.05	2x0.47	2x22000	2x2	0.33	H	D

 B = Faston 6.3x0.8mm      ▲ VDE 60939-2 only  
 D = Flexible leads  
 I = Screw M4

\* other variants on request

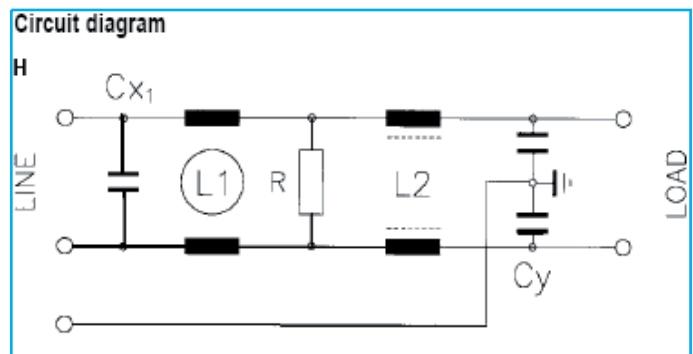

Insertion loss (typical):

Asymmetrical (line to ground) - - - Symmetrical (line to line)

## FAI

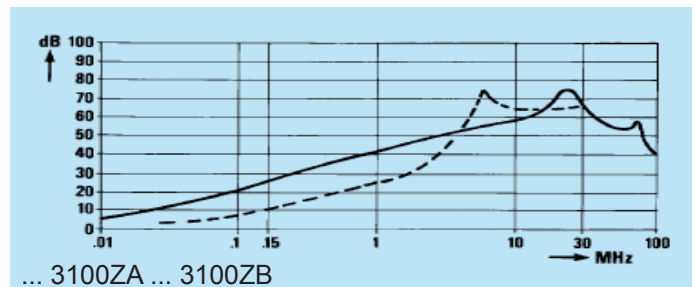
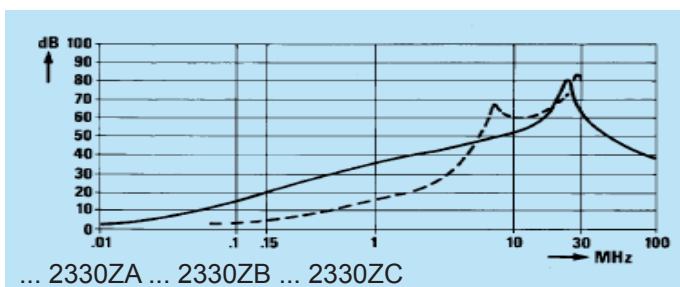
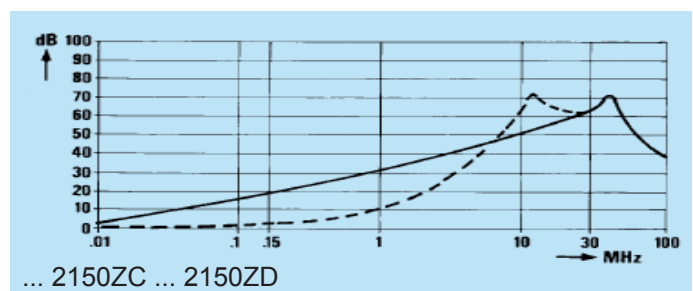
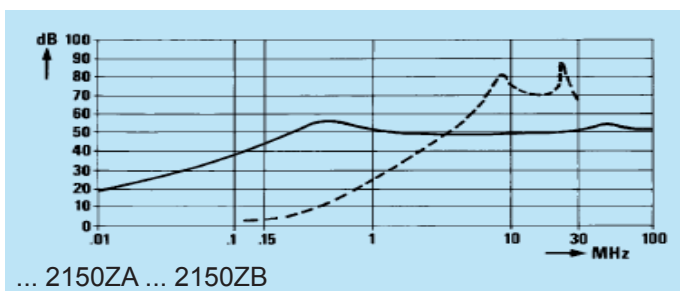

Approvals



Insertion loss (typical): — Asymmetrical (line to ground) - - - Symmetrical (line to line)

## FAK

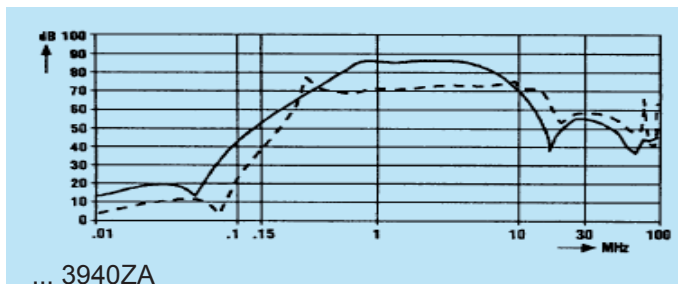
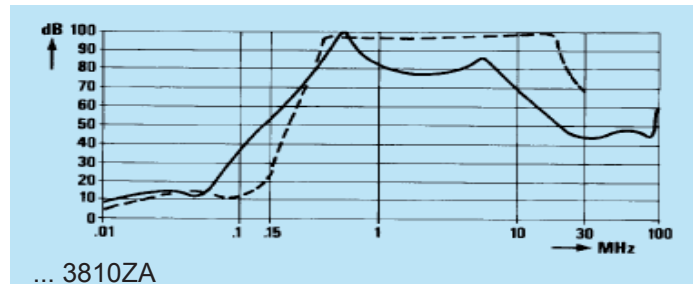
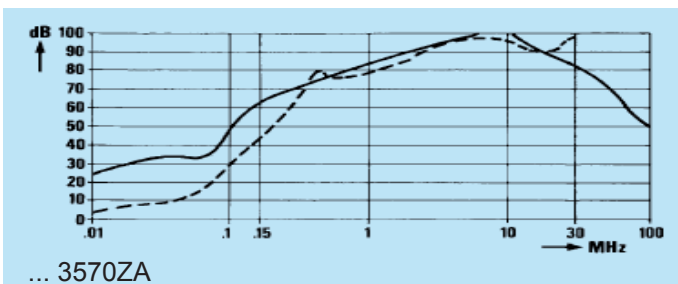
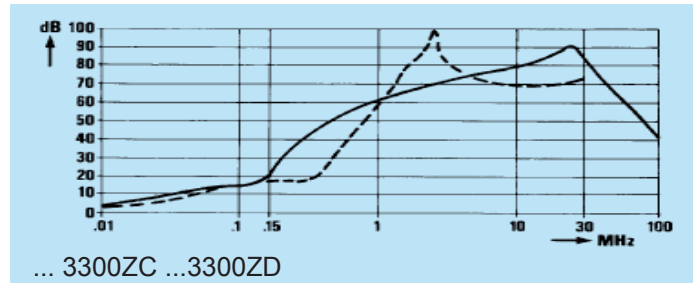
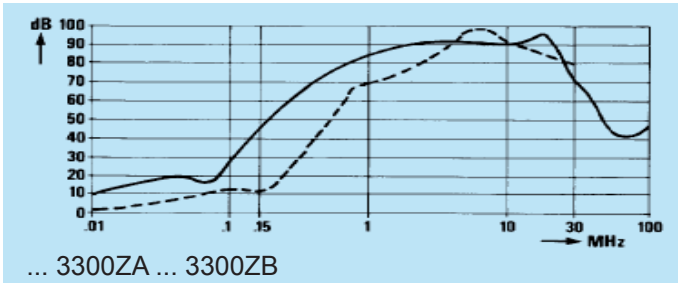

Insertion loss (typical): — Asymmetrical (line to ground) - - - Symmetrical (line to line)

## FAM

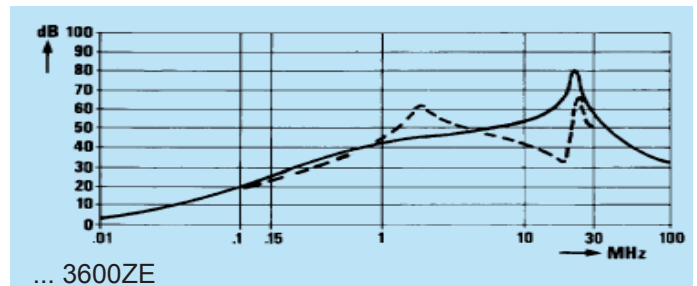
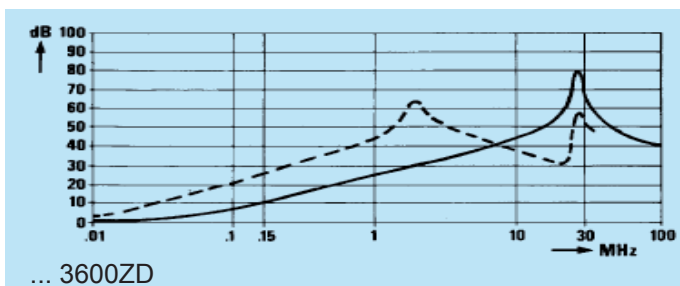
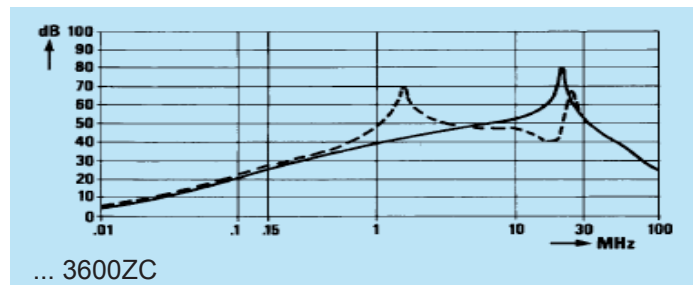
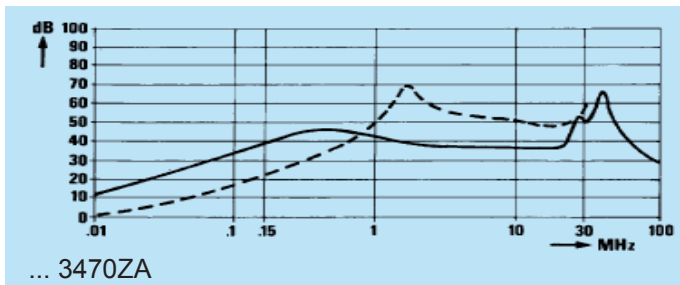
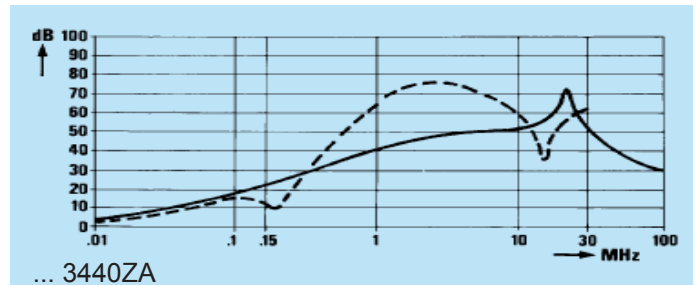
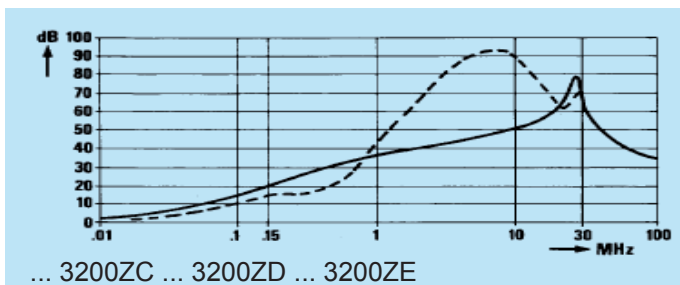
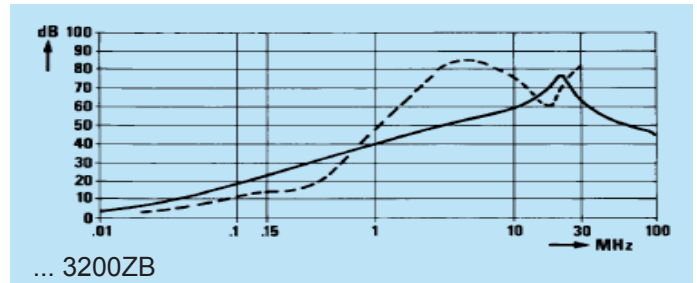
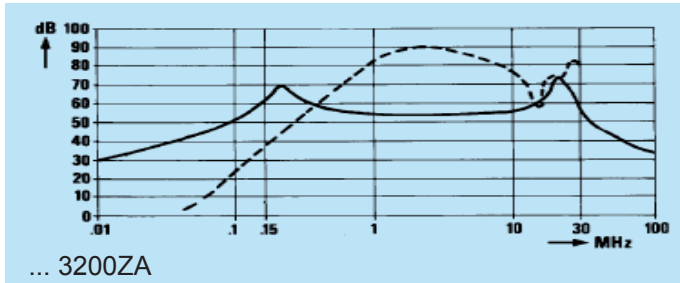

Insertion loss (typical): — Asymmetrical (line to ground) - - - Symmetrical (line to line)

## FAM

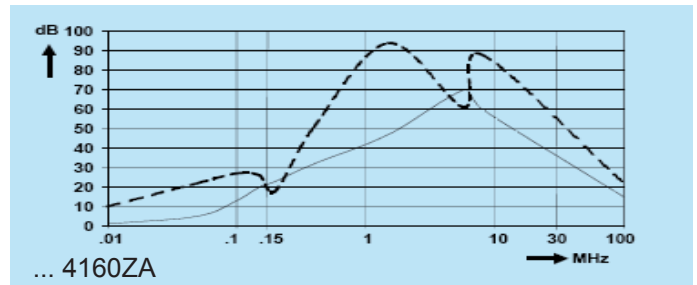
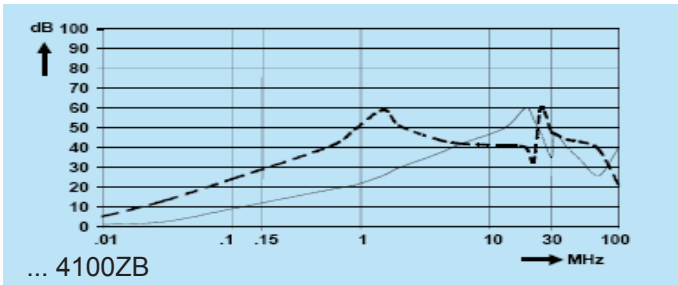
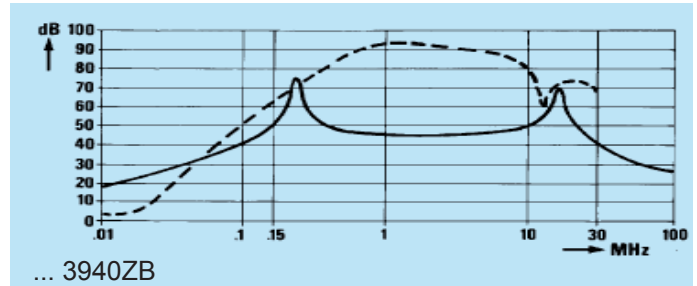
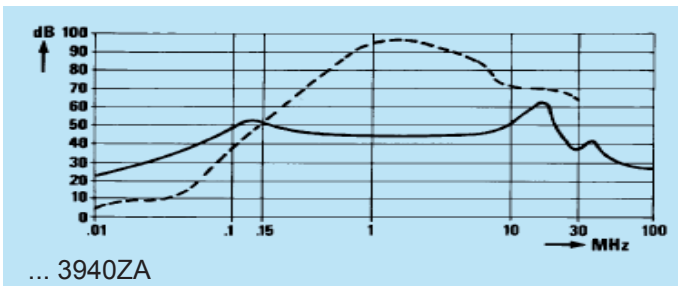
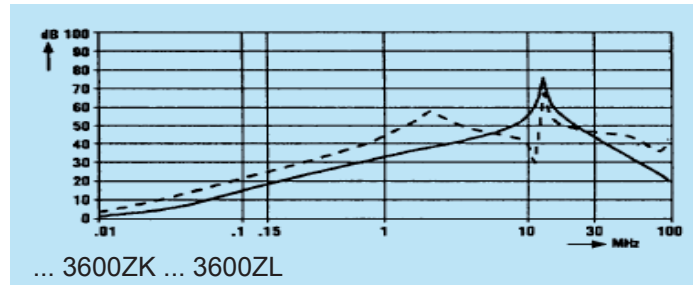
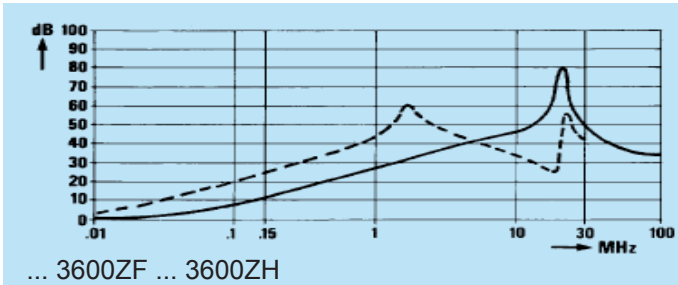

Insertion loss (typical): — Asymmetrical (line to ground) - - - Symmetrical (line to line)

## FAR

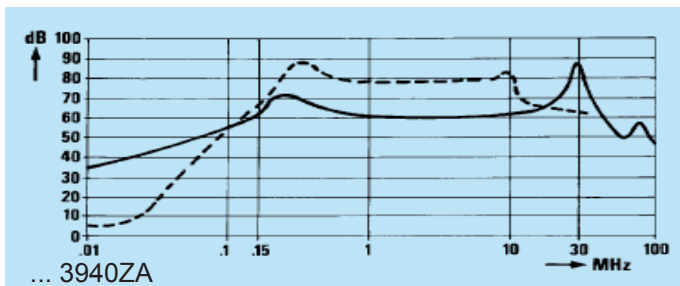
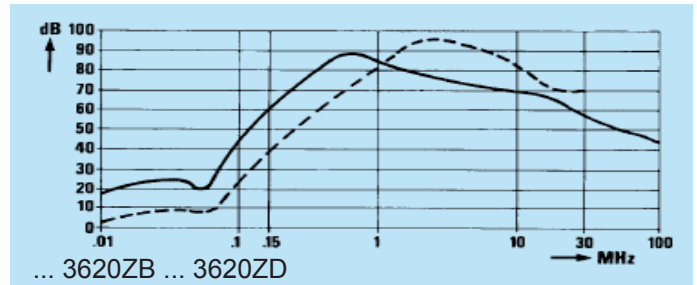
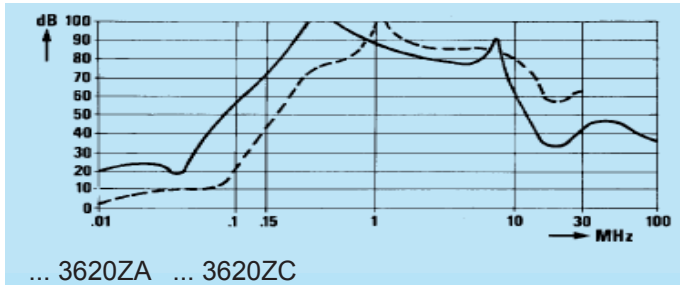

## FAS

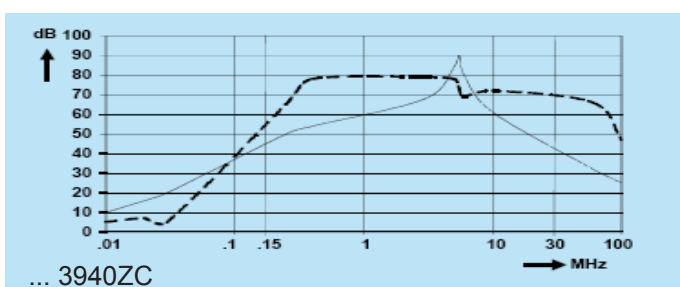
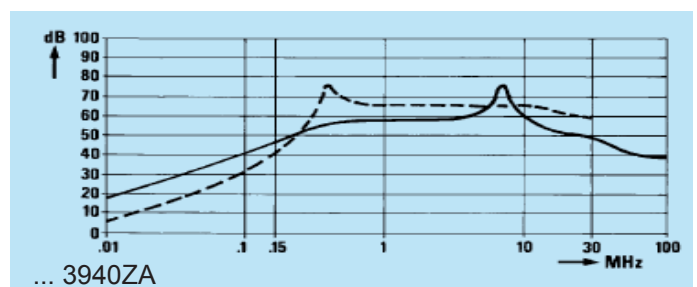
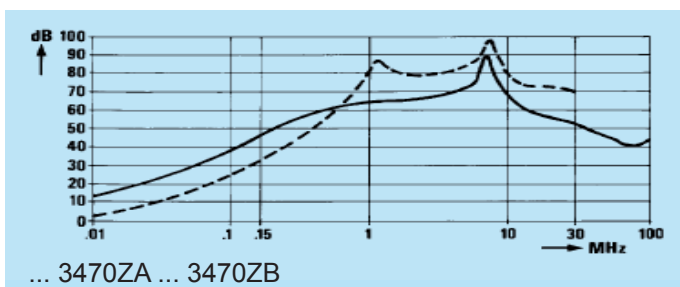
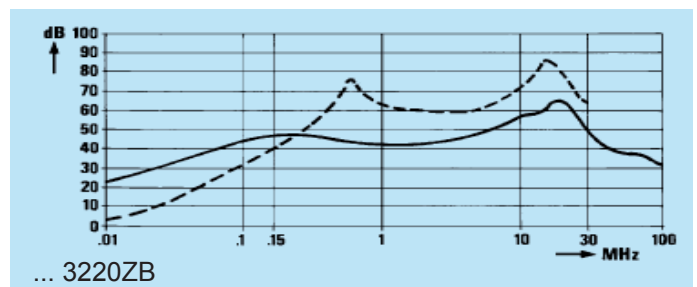
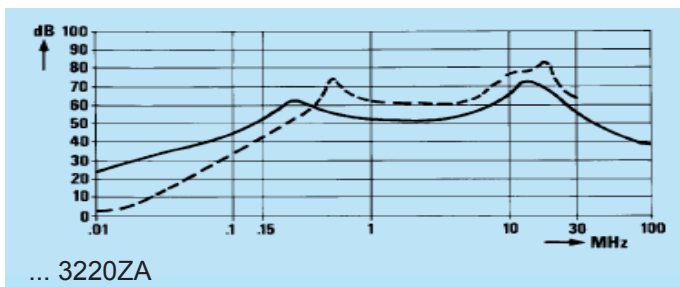

Компания «Океан Электроники» предлагает заключение долгосрочных отношений при поставках импортных электронных компонентов на взаимовыгодных условиях!

Наши преимущества:

- Поставка оригинальных импортных электронных компонентов напрямую с производств Америки, Европы и Азии, а так же с крупнейших складов мира;
- Широкая линейка поставок активных и пассивных импортных электронных компонентов (более 30 млн. наименований);
- Поставка сложных, дефицитных, либо снятых с производства позиций;
- Оперативные сроки поставки под заказ (от 5 рабочих дней);
- Экспресс доставка в любую точку России;
- Помощь Конструкторского Отдела и консультации квалифицированных инженеров;
- Техническая поддержка проекта, помощь в подборе аналогов, поставка прототипов;
- Поставка электронных компонентов под контролем ВП;
- Система менеджмента качества сертифицирована по Международному стандарту ISO 9001;
- При необходимости вся продукция военного и аэрокосмического назначения проходит испытания и сертификацию в лаборатории (по согласованию с заказчиком);
- Поставка специализированных компонентов военного и аэрокосмического уровня качества (Xilinx, Altera, Analog Devices, Intersil, Interpoint, Microsemi, Actel, Aeroflex, Peregrine, VPT, Syfer, Eurofarad, Texas Instruments, MS Kennedy, Miteq, Cobham, E2V, MA-COM, Hittite, Mini-Circuits, General Dynamics и др.);

Компания «Океан Электроники» является официальным дистрибьютором и эксклюзивным представителем в России одного из крупнейших производителей разъемов военного и аэрокосмического назначения «JONHON», а так же официальным дистрибьютором и эксклюзивным представителем в России производителя высокотехнологичных и надежных решений для передачи СВЧ сигналов «FORSTAR».



## JONHON

«JONHON» (основан в 1970 г.)

Разъемы специального, военного и аэрокосмического назначения:

(Применяются в военной, авиационной, аэрокосмической, морской, железнодорожной, горно- и нефтедобывающей отраслях промышленности)

«FORSTAR» (основан в 1998 г.)

ВЧ соединители, коаксиальные кабели,  
кабельные сборки и микроволновые компоненты:

(Применяются в телекоммуникациях гражданского и специального назначения, в средствах связи, РЛС, а так же военной, авиационной и аэрокосмической отраслях промышленности).



Телефон: 8 (812) 309-75-97 (многоканальный)

Факс: 8 (812) 320-03-32

Электронная почта: [ocean@oceanchips.ru](mailto:ocean@oceanchips.ru)

Web: <http://oceanchips.ru/>

Адрес: 198099, г. Санкт-Петербург, ул. Калинина, д. 2, корп. 4, лит. А