

# BWA SERIES RF CO-AXIAL CONNECTORS

The BWA series are converter adapters used for connecting connectors of different series.

- (1) Has mating portions compatible in materials and finish with the respective series.
- (2) Conforms in performance to the lower series of the two connectors to be connected.

## Converter adapter list

| Mating portion 1 |                 | Mating portion 2 |                | Part No.        | CL No.           | Remarks          | Shape         |
|------------------|-----------------|------------------|----------------|-----------------|------------------|------------------|---------------|
| Series name      | Mating portion  | Series name      | Mating portion |                 |                  |                  |               |
| N                | P               | BNC              | P              | NP-BNCP(40)     | 311-0050-7-40    |                  | Fig.1         |
|                  |                 |                  | J              | JUG-201A/U(40)  | 311-0007-8-40    |                  | Fig.2         |
|                  |                 | M                | J              | NP-MJ(40)       | 311-0019-7-40    |                  | Fig.3         |
|                  |                 | S                | J              | N.P-S.J(40)     | 311-0245-6-40    |                  | Fig.4         |
|                  |                 | HRM              | P              | HRM-555S(40)    | 311-0125-4-40    |                  | Fig.5         |
|                  |                 |                  | J              | HRM-554S(40)    | 311-0123-9-40    |                  | Fig.6         |
|                  | J               | BNC              | P              | UG-349/U(40)    | 311-0004-0-40    |                  | Fig.7         |
|                  |                 |                  | J              | NJ-BNCJ(40)     | 311-0005-2-40    |                  | Fig.8         |
|                  |                 |                  |                | NJ-BNCJ-PA(40)  | 311-0014-3-40    | Panel-mount type | Fig.9         |
|                  |                 | M                | P              | NJ-MP(40)       | 311-0018-4-40    |                  | Fig.10        |
|                  |                 |                  | J              | NJ-MJ(40)       | 311-0011-5-40    |                  | Fig.11        |
|                  |                 | TNC              | P              | N.J-TNC.P(40)   | 311-0225-9-40    |                  | Fig.12        |
|                  |                 | HRM              | P              | HRM-553S        | 311-0121-3       |                  | Fig.13        |
|                  |                 |                  | J              | HRM-552S        | 311-0119-1       |                  | Fig.15        |
|                  |                 | BNC              | P              | M               | P                | BNCP-MP(40)      | 311-0062-6-40 |
| J                | BNCP-MJ(40)     |                  |                |                 | 311-0008-0-40    |                  | Fig.18        |
| S                | P               |                  |                | SP-BNCP(40)     | 311-0055-0-40    |                  | Fig.19        |
|                  | J               |                  |                | SJ-BNCP(40)     | 311-0060-0-40    |                  | Fig.20        |
| UM               | J               |                  |                | BNCP-UMJ(40)    | 311-0065-4-40    |                  | Fig.21        |
| MSS              | P               |                  |                | BNCP-MSSP(40)   | 311-0107-2-40    |                  | Fig.22        |
|                  | J               |                  |                | BNCP-MSSJ(40)   | 311-0082-3-40    |                  | Fig.23        |
| HRM              | P               |                  |                | HRM-519(40)     | 311-0101-6-40    |                  | Fig.24        |
|                  | J               |                  |                | HRM-518(40)     | 311-0100-3-40    |                  | Fig.25        |
| J                | UHF             |                  |                | P               | UG-273/U(40)     | 311-0003-7-40    |               |
|                  | M               |                  | P              | BNCJ-MP(40)     | 311-0009-3-40    |                  | Fig.27        |
|                  |                 |                  | J              | MJ-BNCJ(40)     | 311-0020-6-40    |                  | Fig.28        |
|                  | S               |                  | P              | SP-BNCJ(40)     | 311-0058-9-40    |                  | Fig.29        |
|                  |                 |                  | J              | SJ-BNCJ(40)     | 311-0054-8-40    |                  | Fig.30        |
|                  | SJ-BNCJ-PA(40)  |                  |                | 311-0108-5-40   | Panel-mount type | Fig.31           |               |
|                  | TNC             |                  | J              | BNC.J-TNC.J(40) | 311-0194-7-40    |                  | Fig.32        |
|                  | UM              |                  | P              | BNCJ-UMP(40)    | 311-0052-2-40    |                  | Fig.33        |
|                  |                 |                  | J              | BNCJ-UMJ(40)    | 311-0053-5-40    |                  | Fig.34        |
|                  | BNCJ-UMJ-PA(40) |                  |                | 311-0103-1-40   | Panel-mount type | Fig.35           |               |
|                  | MSS             |                  | P              | BNCJ-MSSP(40)   | 311-0081-0-40    |                  | Fig.36        |
| J                |                 |                  | BNCJ-MSSJ(40)  | 311-0066-7-40   |                  | Fig.37           |               |

# BWA SERIES RF CO-AXIAL CONNECTORS

| Mating portion 1 |                | Mating portion 2 |                   | Part No.         | CL No.            | Remarks                        | Shape                    |        |
|------------------|----------------|------------------|-------------------|------------------|-------------------|--------------------------------|--------------------------|--------|
| Series name      | Mating portion | Series name      | Mating portion    |                  |                   |                                |                          |        |
| BNC              | J              | HRM              | P                 | HRM-517(40)      | 311-0099-6-40     |                                | Fig.38                   |        |
|                  |                |                  | J                 | HRM-516(40)      | 311-0102-9-40     |                                | Fig.39                   |        |
|                  |                | POD              | P                 | BNCJ-PODP(40)    | 311-0160-5-40     |                                | Fig.40                   |        |
|                  |                |                  | J                 | BNCJ-PODJ(40)    | 311-0161-8-40     |                                | Fig.41                   |        |
|                  |                | PO6              | J                 | BNCJ-PO6J(40)    | 311-0167-4-40     |                                | Fig.42                   |        |
| S                | P              | HRM              | P                 | HRM-509(40)      | 311-0093-0-40     |                                | Fig.43                   |        |
|                  |                |                  | J                 | HRM-508(40)      | 311-0092-7-40     |                                | Fig.44                   |        |
|                  | J              | HRM              | P                 |                  | HRM-507(40)       | 311-0091-4-40                  |                          | Fig.45 |
|                  |                |                  |                   |                  | HRM-512(40)       | 311-0098-3-40                  | Panel-mount type         | Fig.46 |
|                  |                |                  |                   | HRM-512S(40)     | 311-0144-9-40     | Panel-mount type, S type       | Fig.46                   |        |
|                  |                |                  | J                 |                  | HRM-506(40)       | 311-0090-1-40                  |                          | Fig.47 |
|                  |                |                  |                   |                  | HRM-511(40)       | 311-0094-2-40                  | Panel-mount type         | Fig.48 |
|                  |                |                  |                   |                  | HRM-511S(40)      | 311-0143-6-40                  | Panel-mount type, S type | Fig.48 |
| TNC              | J              | HRM              | J                 | HRMJ-TNCJ-PA(40) | 311-0202-3-40     | Panel-mount type               | Fig.49                   |        |
| UM               | P              | HRM              | J                 | UM.P-HRM.J(40)   | 311-0176-5-40     |                                | Fig.50                   |        |
|                  | J              | HRM              | J                 | HRMJ-UMJ(40)     | 311-0164-6-40     |                                | Fig.51                   |        |
| HRM              | P              | POB              | P                 | HRMP-POBP-1(40)  | 311-0169-0-40     |                                | Fig.52                   |        |
|                  |                |                  | J                 | HRMP-POBJ        | 311-0152-7        |                                | Fig.53                   |        |
|                  |                | POD              | J                 | HRM.P-POD.J(40)  | 311-0177-8-40     |                                | Fig.54                   |        |
|                  |                | POD1             | J                 | HRMP-POD1J(40)   | 311-0253-4-40     |                                | Fig.55                   |        |
|                  |                | PO6              | J                 | HRMP-PO6J(40)    | 311-0172-4-40     |                                | Fig.56                   |        |
|                  |                | S,FL             | J                 | HRMP-S.FLJ-2(40) | 311-0249-7-40     | For inspecting harnesses parts | Fig.57                   |        |
|                  |                | H,FL             | J                 | HRMP-H.FLJ(40)   | 311-0232-4-40     | For inspecting harnesses parts | Fig.58                   |        |
|                  |                | HRMM             | P                 |                  | HRMP-HRMMJ(40)    | 311-0250-6-40                  |                          | Fig.59 |
|                  |                |                  |                   | J                | HRMP-HRMMJ        | 311-0243-0                     |                          | Fig.60 |
|                  |                |                  |                   | J                | HRMP-HRMMJ-LA(40) | 311-0226-1-40                  |                          | Fig.61 |
|                  |                | J                | POB               | P                |                   | HRMJ-POBP(40)                  | 311-0151-4-40            |        |
|                  |                |                  |                   |                  | HRMJ-POBP-PA(40)  | 311-0206-4-40                  |                          | Fig.63 |
|                  | J              |                  |                   |                  | HRMJ-POBJ(40)     | 311-0149-2-40                  |                          | Fig.64 |
|                  |                |                  |                   |                  | HRMJ-POBJ-PA(40)  | 311-0150-1-40                  |                          | Fig.65 |
|                  | POD            |                  | P                 | HRMJ-PODP(40)    | 311-0157-0-40     |                                | Fig.66                   |        |
|                  | POD1           |                  | P                 | HRMJ-POD1P-1(40) | 311-0254-7-40     |                                | Fig.67                   |        |
|                  | PO6            |                  | P                 | HRMJ-PO6P(40)    | 311-0173-7-40     |                                | Fig.68                   |        |
|                  | PO51           |                  | P                 | HRMJ-PO51P(40)   | 311-0231-1-40     |                                | Fig.69                   |        |
|                  | FL             |                  | P                 | HRMJ-FLP-1(40)   | 311-0195-0-40     |                                | Fig.70                   |        |
|                  |                |                  | J                 | HRMJ-FLJ(40)     | 311-0179-3-40     |                                | Fig.71                   |        |
|                  | S,FL           |                  | P                 | HRMJ-S.FLP(40)   | 311-0218-3-40     |                                | Fig.72                   |        |
|                  | H,FL           |                  | P                 | HRMJ-H.FLP-3(40) | 311-0264-0-40     |                                | Fig.73                   |        |
|                  | HRMM           | P                |                   | HRMJ-HRMMJ-2     | 311-0221-8        |                                | Fig.74                   |        |
|                  |                |                  | HRMJ-HRMMJ-LA(40) | 311-0227-4-40    |                   | Fig.75                         |                          |        |
| J                |                | HRMJ-HRMMJ       | 311-0220-5        |                  | Fig.76            |                                |                          |        |

- Note 1. Part No. NP-BNCP of Fig.1 is shown that series name N, coupling part p (plug) for connecting part 1 and series name BNC, coupling part P (plug) for connecting part 2.
2. Series name of each connecting parts are shown in order to HIROSE's CL numbers.

# BWA SERIES RF CO-AXIAL CONNECTORS

|                                  |                                   |
|----------------------------------|-----------------------------------|
| <p>Fig.1</p> <p>NP-BNCP(40)</p>  | <p>Fig.2</p> <p>UG-201A/U(40)</p> |
| <p>Fig.3</p> <p>NP-MJ(40)</p>    | <p>Fig.4</p> <p>N.P-S.J(40)</p>   |
| <p>Fig.5</p> <p>HRM-555S(40)</p> | <p>Fig.6</p> <p>HRM-554S(40)</p>  |
| <p>Fig.7</p> <p>UG-349/U(40)</p> | <p>Fig.8</p> <p>NJ-BNCJ(40)</p>   |

# BWA SERIES RF CO-AXIAL CONNECTORS

Fig.9

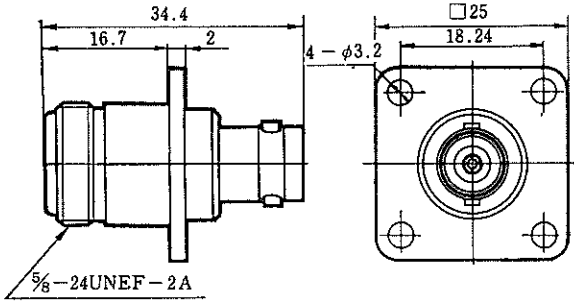

NJ-BNCJ-PA(40)

Fig.10

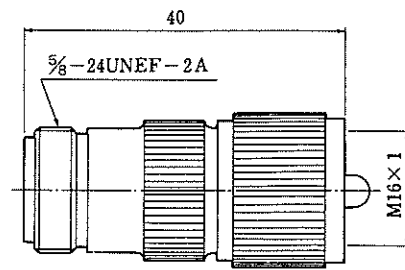

NJ-MP(40)

Fig.11

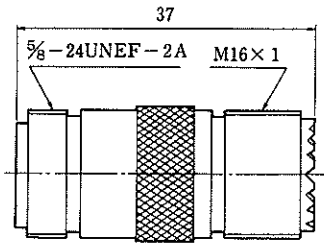

NJ-MJ(40)

Fig.12

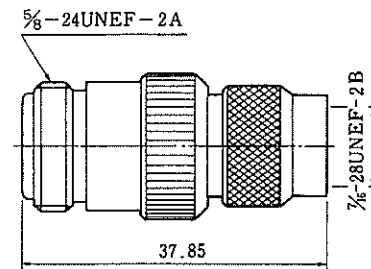

NJ-TNC.P(40)

Fig.13

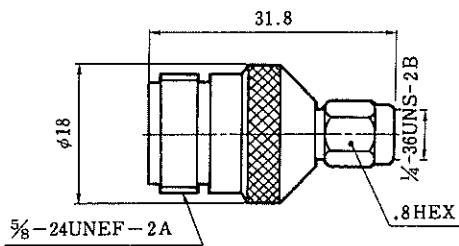

HRM-553S

Fig.15

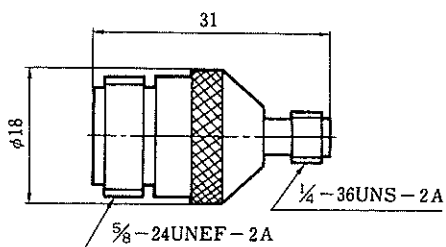

HRM-552S

# BWA SERIES RF CO-AXIAL CONNECTORS

Fig.17

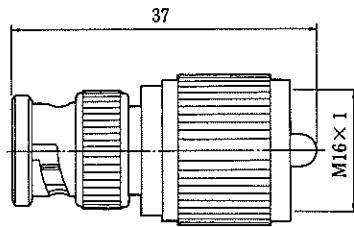

BNCMP-MP(40)

Fig.18

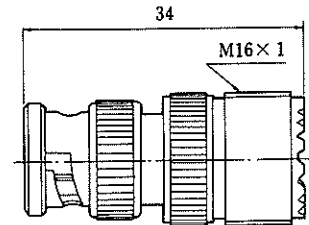

BNCMP-MJ(40)

Fig.19

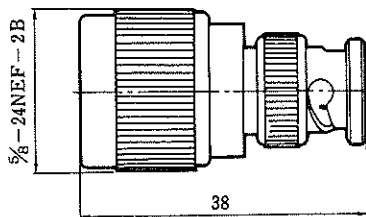

SP-BNCP(40)

Fig.20

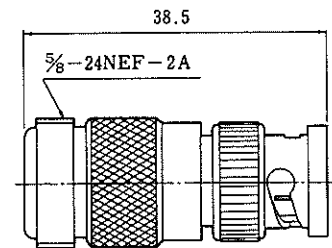

SJ-BNCP(40)

Fig.21

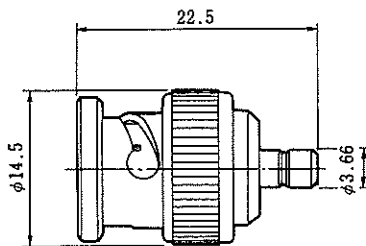

BNCMP-UMJ(40)

Fig.22

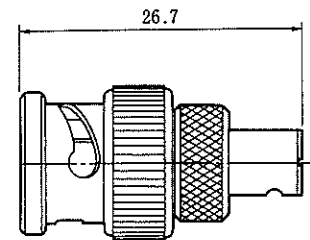

BNCMP-MSSP(40)

Fig.23

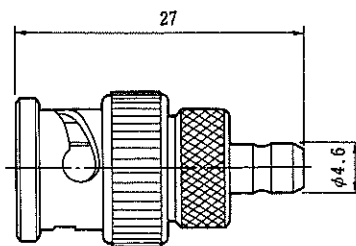

BNCMP-MSSJ(40)

Fig.24

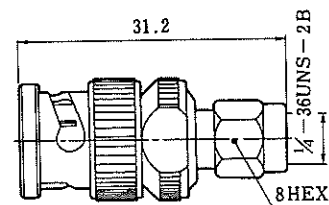

HRM-519(40)

# BWA SERIES RF CO-AXIAL CONNECTORS

Fig.25

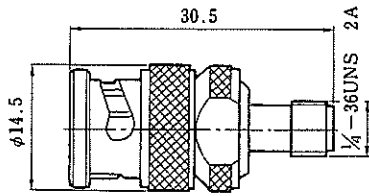

HRM-518(40)

Fig.26

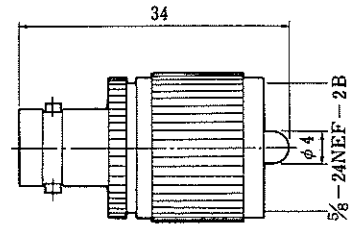

UG-273/U(40)

Fig.27

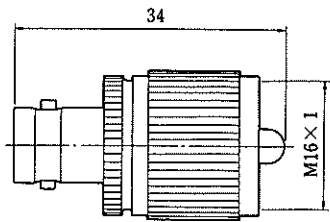

BNCJ-MP(40)

Fig.28

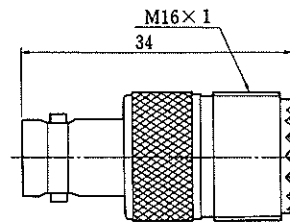

MJ-BNCJ(40)

Fig.29

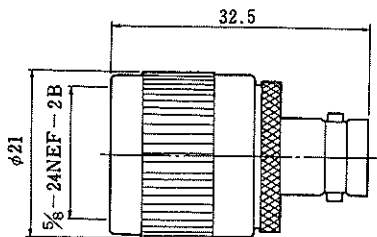

SP-BNCJ(40)

Fig.30

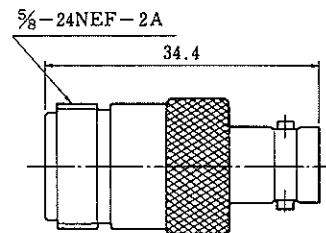

SJ-BNCJ(40)

Fig.31

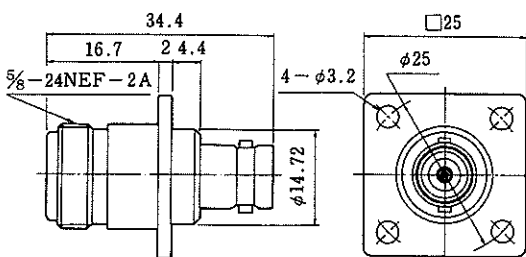

SJ-BNCJ-PA(40)

Fig.32

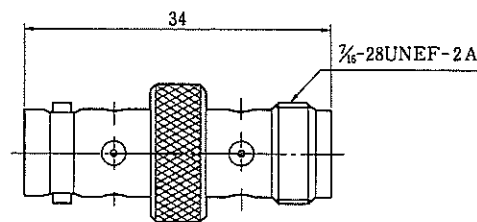

BNCJ-TNCJ(40)

# BWA SERIES RF CO-AXIAL CONNECTORS

Fig.33

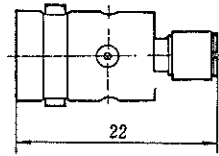

BNCJ-UMP(40)

Fig.34

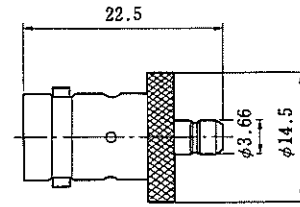

BNCJ-UMJ(40)

Fig.35

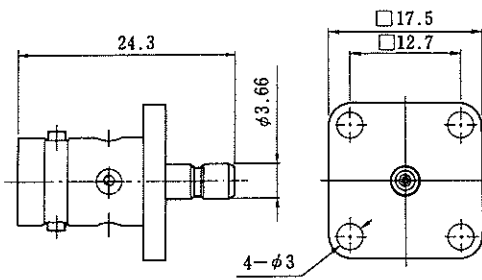

BNCJ-UMJ-PA(40)

Fig.36

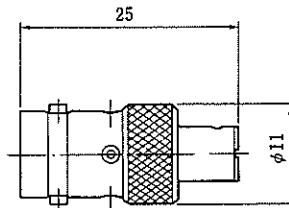

BNCJ-MSSP(40)

Fig.37

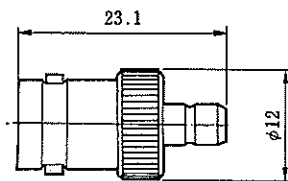

BNCJ-MSSJ(40)

Fig.38

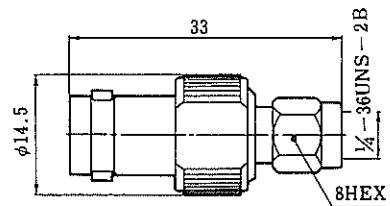

HRM-517(40)

Fig.39

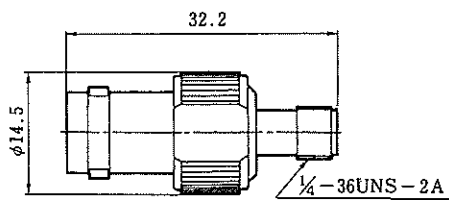

HRM-516(40)

Fig.40

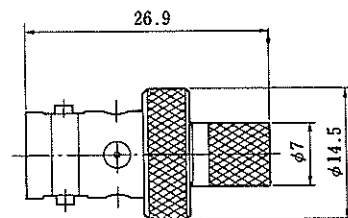

BNCJ-PODP(40)

# BWA SERIES RF CO-AXIAL CONNECTORS

Fig.41

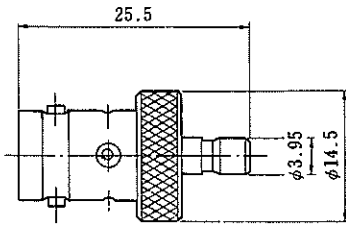

BNCJ-PODJ(40)

Fig.42

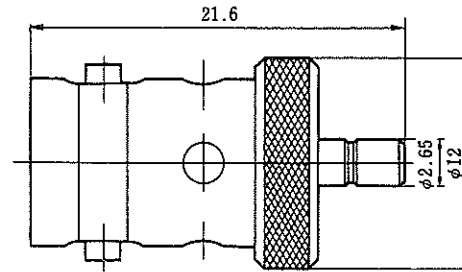

BNCJ-PO6J(40)

Fig.43

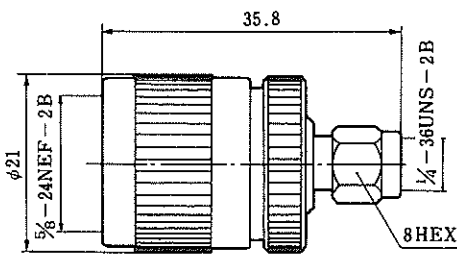

HRM-509(40)

Fig.44

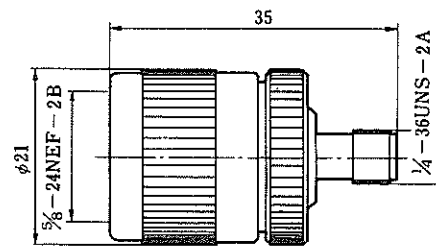

HRM-508(40)

Fig.45

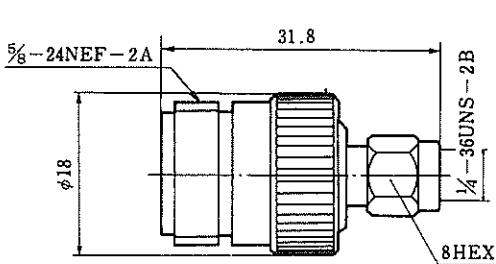

HRM-507(40)

Fig.46

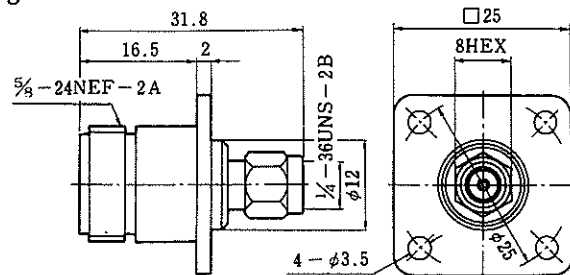

HRM-512(40) HRM-512S(40)

Fig.47

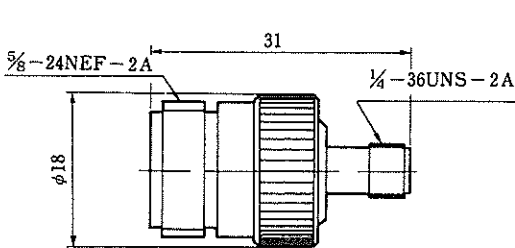

HRM-506(40)

Fig.48

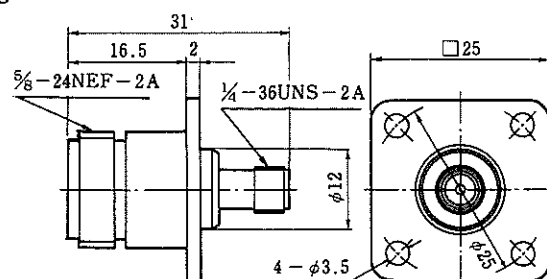

HRM-511(40) HRM-511S(40)



# BWA SERIES RF CO-AXIAL CONNECTORS

Fig.49

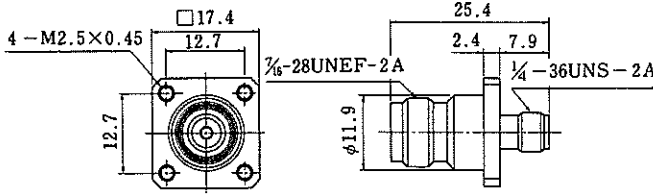

HRMJ-TNCJ-PA(40)

Fig.50

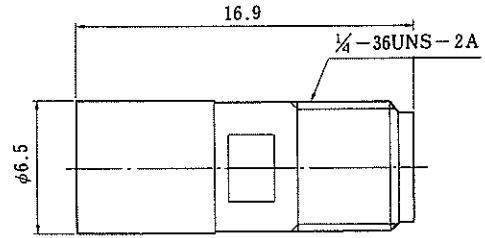

UM.P-HRMJ(40)

Fig.51

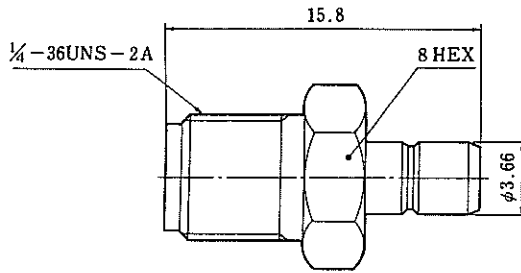

HRMJ-UMJ(40)

Fig.52

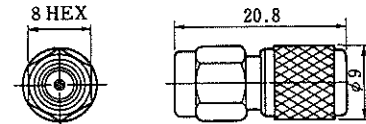

HRMP-POBP-1(40)

Fig.53

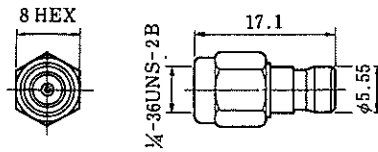

HRMP-POBJ

Fig.54

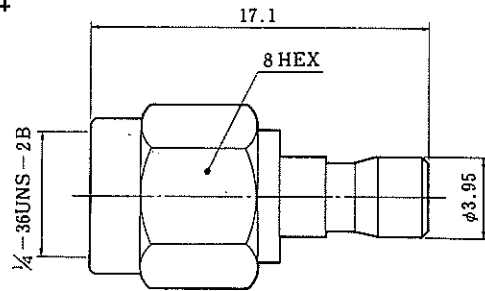

HRM.P-POD.J(40)

Fig.55

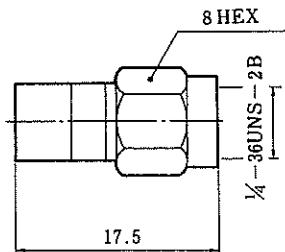

HRMP-POD1J(40)

Fig.56

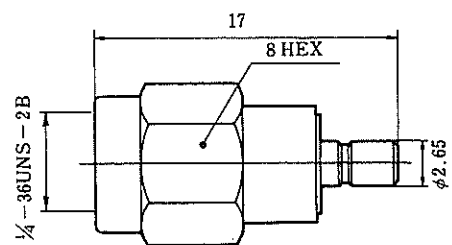

HRMP-PO6J(40)

# BWA SERIES RF CO-AXIAL CONNECTORS

Fig.57

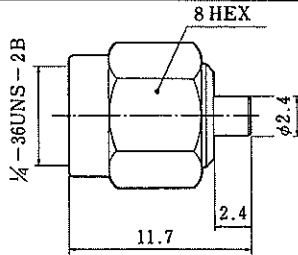

Note : The mating portion on the S. FL side mates with the S. FL and S. FL2 plugs.  
 Having no locking mechanism, however, the S. FL side mating portion can be used only for performance measurement.

HRMP-S.FLJ-2(40)

Fig.58

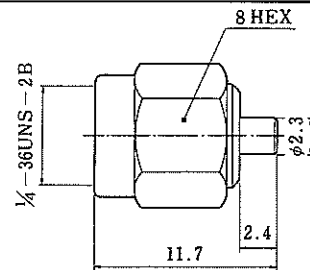

Note : Having no locking mechanism, however, the S. FL side mating portion can be used only for performance measurement.

HRMP-H.FLJ(40)

Fig.59

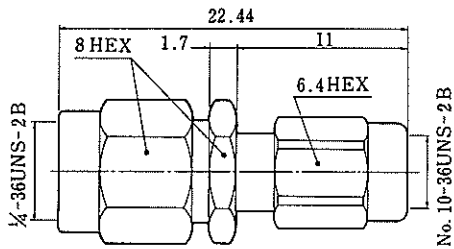

HRMP-HRMP(40)

Fig.60

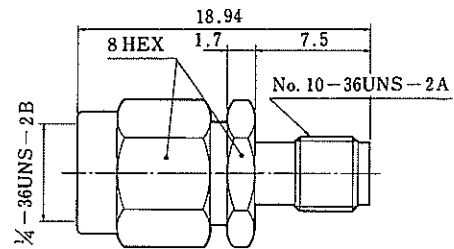

HRMP-HRMM(40)

Fig.61

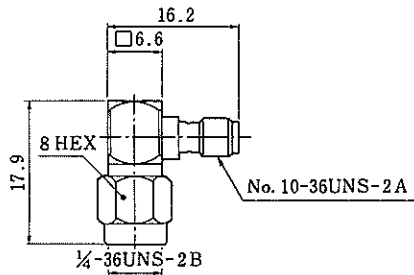

HRMP-HRMMJ-LA(40)

Fig.62

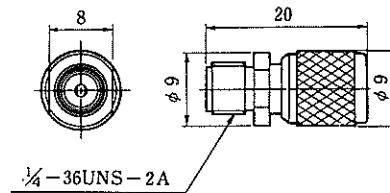

HRMJ-POBP(40)

Fig.63

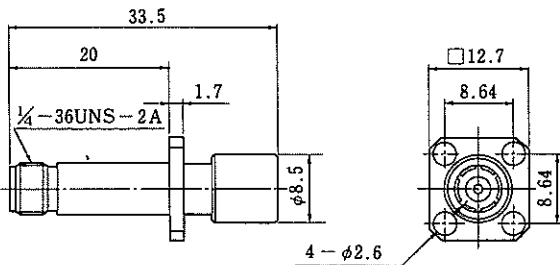

HRMJ-POBP-PA(40)

Fig.64

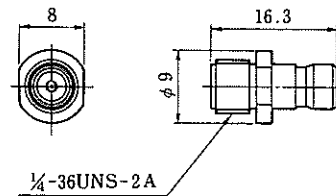

HRMJ-POBJ(40)

# BWA SERIES RF CO-AXIAL CONNECTORS

Fig.65

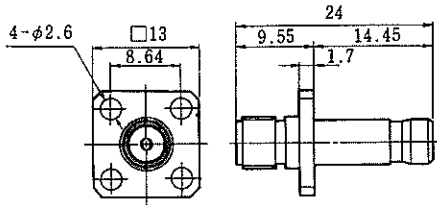

HRMJ-POBJ-PA(40)

Fig.66

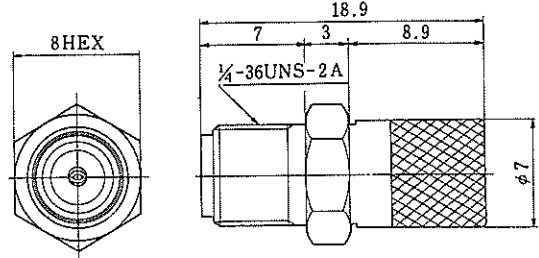

HRMJ-PODP(40)

Fig.67

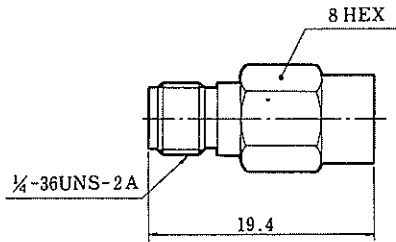

HRMJ-POD1P-1(40)

Fig.68

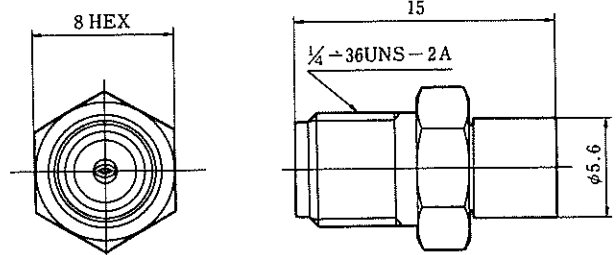

HRMJ-PO6P(40)

Fig.69

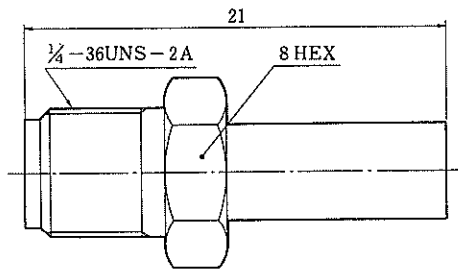

HRMJ-PO51P(40)

Fig.70

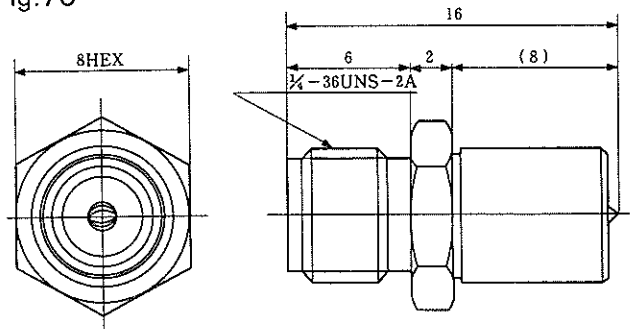

HRMJ-FLP-1(40)

Fig.71

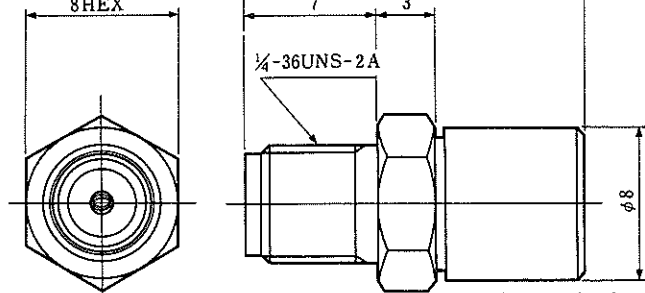

HRMJ-FLJ(40)

Note: Having no locking mechanism, however, the FL side mating portion can be used only for performance measurement.

Fig.72

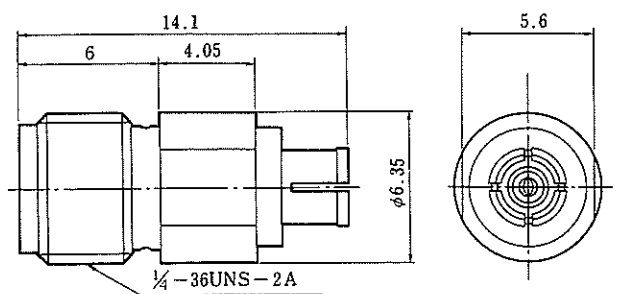

HRMJ-S.FLP(40)

Note: Compatible with S. FL and S. FL2.

# BWA SERIES RF CO-AXIAL CONNECTORS

Fig. 73

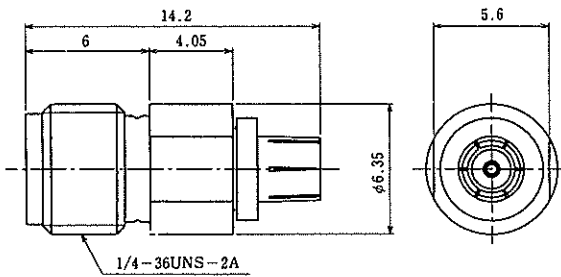

HRMJ-H.FLP-3(40)

Fig. 74

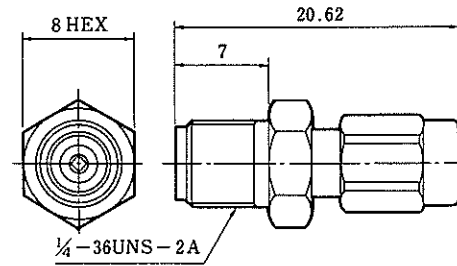

HRMJ-HRMMP-2

Fig. 75

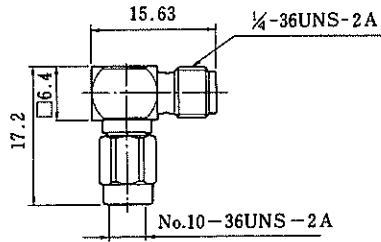

HRMJ-HRMMP-LA(40)

Fig. 76

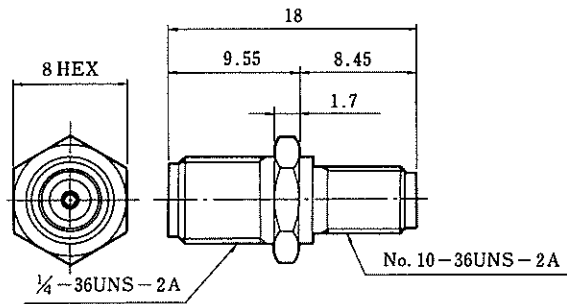

HRMJ-HRMMJ

Компания «Океан Электроники» предлагает заключение долгосрочных отношений при поставках импортных электронных компонентов на взаимовыгодных условиях!

Наши преимущества:

- Поставка оригинальных импортных электронных компонентов напрямую с производств Америки, Европы и Азии, а так же с крупнейших складов мира;
- Широкая линейка поставок активных и пассивных импортных электронных компонентов (более 30 млн. наименований);
- Поставка сложных, дефицитных, либо снятых с производства позиций;
- Оперативные сроки поставки под заказ (от 5 рабочих дней);
- Экспресс доставка в любую точку России;
- Помощь Конструкторского Отдела и консультации квалифицированных инженеров;
- Техническая поддержка проекта, помощь в подборе аналогов, поставка прототипов;
- Поставка электронных компонентов под контролем ВП;
- Система менеджмента качества сертифицирована по Международному стандарту ISO 9001;
- При необходимости вся продукция военного и аэрокосмического назначения проходит испытания и сертификацию в лаборатории (по согласованию с заказчиком);
- Поставка специализированных компонентов военного и аэрокосмического уровня качества (Xilinx, Altera, Analog Devices, Intersil, Interpoint, Microsemi, Actel, Aeroflex, Peregrine, VPT, Syfer, Eurofarad, Texas Instruments, MS Kennedy, Miteq, Cobham, E2V, MA-COM, Hittite, Mini-Circuits, General Dynamics и др.);

Компания «Океан Электроники» является официальным дистрибьютором и эксклюзивным представителем в России одного из крупнейших производителей разъемов военного и аэрокосмического назначения «JONHON», а так же официальным дистрибьютором и эксклюзивным представителем в России производителя высокотехнологичных и надежных решений для передачи СВЧ сигналов «FORSTAR».



## JONHON

«JONHON» (основан в 1970 г.)

Разъемы специального, военного и аэрокосмического назначения:

(Применяются в военной, авиационной, аэрокосмической, морской, железнодорожной, горно- и нефтедобывающей отраслях промышленности)

«FORSTAR» (основан в 1998 г.)

ВЧ соединители, коаксиальные кабели, кабельные сборки и микроволновые компоненты:

(Применяются в телекоммуникациях гражданского и специального назначения, в средствах связи, РЛС, а так же военной, авиационной и аэрокосмической отраслях промышленности).



Телефон: 8 (812) 309-75-97 (многоканальный)

Факс: 8 (812) 320-03-32

Электронная почта: [ocean@oceanchips.ru](mailto:ocean@oceanchips.ru)

Web: <http://oceanchips.ru/>

Адрес: 198099, г. Санкт-Петербург, ул. Калинина, д. 2, корп. 4, лит. А