

Amphenol

Amphenol-Tuchel Electronics GmbH

Series C 146

Heavy Duty Connectors
Core Programme



The Company

Amphenol-Tuchel Electronics GmbH is a member of the USA based Amphenol Corporation. With our own global presence we offer our customers exceptional technical support and service in the areas of development, production and distribution. Amphenol-Tuchel Electronics GmbH has a successful history as a partner to our customers and sets standards for connector technology.



General information

These connectors are designed and produced in conformity with the low voltage directive (73/23/EWG) respectively Gerätesicherheitsgesetz (German law) and are especially in accordance with the standards DIN EN 61984 (VDE0627); IEC 60664-1 (VDE 0110-1) nad IEC 60529. The connectors may be used only within the technical ratings.

The indicated dimensions with the panel cut-outs represent reference values and are in the concrete application with products to be co-ordinated.

It is the users responsibility to check whether the components illustrated in this catalogue comply with different regulations from those stated in special fields of application which we are unable to foresee. We reserve the right to modify designs in order to improve quality, keep pace with technological advancement or meet particular requirements in production. This catalogue must not be used in any form or manner without our prior approval in writing (Copyright Law, Fair Trading Law, Civil Code).

C 146

Characteristics

Series	C 146 D							C 146 DD				C 146 E					C 146 EE			
Number of contacts	7+PE, 8	15+ PE	25+ PE	40+ PE	50+ PE	64+ PE	128+ PE	24+ PE	42+ PE	72+ PE	108+ PE	6 +	10 +	16 +	24 +	48 +	10+ PE	18+ PE	32+ PE	46+ PE
Termination	crimp							crimp				crimp/screw								
Wire gauge	0,14 - 2,5							0,14 - 2,5				0,5 - 4,0 0,25 - 2,5					0,5 - 4,0			
Flammability (UL 94)	V - 0							V - 0				V - 0					V - 0			
Certifications	UL, CSA							UL, CSA									UL, CSA			
according DIN EN 175301-801		✓	✓	✓		✓														
Insertion and withdrawal force in N	10 - 15	20 - 30	40 - 60	60 - 90	80 - 120	100 - 150	200 - 300					SCR ¹ : 20-30 CR: 10-20	SCR ¹ : 40-50 CR: 30-40	SCR ¹ : 80-100 CR: 45-60	SCR ¹ : 100-120 CR: 70-100	SCR ¹ : 200-240 CR: 140-200				
Rated voltage (VDE)	250							250				400					500			
Rated voltage (UL, CSA) in V	600							600				600					600			
Pollution degree	3							2 (3 in mated and locked condition)				3					3			
Installation (overvoltage) category	III							III				III					III			
Rated current (Tu=40°C) in A	16	12	10				9	8	22	19		18			16					
Lower temperature in °C	-40							-40				-40					-40			
Upper temperature in °C	+125							+100				+125					+100			

¹SCR = screw, CR = crimp

Series	C 146 M										C 146 A							
Number of contacts	20	10	10	5	3	4+PE/5	3	3	Rj45 + 4	Pneu	3,4 +	10 +	16 +	32 +				
Termination	crimp	crimp	crimp	crimp	crimp	crimp	crimp&solder	crimp	crimp&push	tube								
Contacts	stamped	stamped	turned	turned	turned	stamped	Coax	turned	turned	termination	screw							
Wire gauge	0,09 - 0,5	0,14 - 2,5	0,14 - 2,5	0,5 - 4,0	1,5 - 10	0,5 - 4,0		1,5 - 10	0,14 - 2,5	2,5 + 4,0	0,25 - 2,5							
Flammability (UL 94)	V - 0										V - 0							
Certifications	UL, CSA, SEV, VDE										UL, CSA							
Insertion and withdrawal force in N	10 - 15	20 - 25	25 - 30	25 - 30	20 - 30	15 - 20	25 - 30	20 - 30	15 - 20		15 - 20	50 - 70	80 - 100	160 - 200				
Rated voltage (VDE)	63	250	250	400	630	1000	250	1000	125V + 400V		400	250						
Rated voltage (UL, CSA) in V	63	250	250	400	630	1000	250	1000	125V + 400V		600							
Pollution degree	3										3							
Installation (overvoltage) category	III	III	III							III								
Rated current (Tu=40°C) in A	5	10	10	20	50	16		50	1,5 and 13		18	16	14					
Lower temperature in °C	-40										-20				-40			
Upper temperature in °C	+ 125		+ 100		+ 125					+ 80		+ 100		+ 100				

C 146 E

Inserts

Description - Figure	Part No.		Description - Figure	Part No.	
	Male insert	Female insert		Male insert	Female insert
Contact insert screw termination 6+PE 	C146 10A006 102 1 ¹⁾ (with wire protection)	C146 10B006 102 1 ¹⁾ (with wire protection)	Contact insert screw termination 10+PE 	C146 10A010 102 1 ¹⁾ (with wire protection)	C146 10B010 102 1 ¹⁾ (with wire protection)
Contact insert for stamped contacts 6+PE 	C146 10A006 000 1	C146 10B006 000 1	Contact insert for stamped contacts 10+PE 	C146 10A010 000 1	C146 10B010 000 1
Contact insert for turned contacts 6+PE 	C146 10A006 500 1	C146 10B006 500 1	Contact insert for turned contacts 10+PE 	C146 10A010 500 1	C146 10B010 500 1
Contact insert screw termination 16+PE 	C146 10A016 102 1 ¹⁾ (with wire protection)	C146 10B016 102 1 ¹⁾ (with wire protection)	Contact insert screw termination ²⁾ 24+PE 	C146 10A024 102 1 ¹⁾ (with wire protection)	C146 10B024 102 1 ¹⁾ (with wire protection)
Contact insert for stamped contacts 16+PE 	C146 10A016 000 1	C146 10B016 000 1	Contact insert for stamped contacts ²⁾ 24+PE 	C146 10A024 000 1	C146 10B024 000 1
Contact insert for turned contacts 16+PE 	C146 10A016 500 1	C146 10B016 500 1	Contact insert for turned contacts ²⁾ 24+PE 	C146 10A024 500 1	C146 10B024 500 1

C 146 EE

Inserts

Description - Figure	Part No.		Description - Figure	Part No.	
	Male insert	Female insert		Male insert	Female insert
Contact insert 10+PE 	C146 10A010 500 10	C146 10B010 500 10	Contact insert 18+PE 	C146 10A018 500 10	C146 10B018 500 10
Contact insert 32+PE 	C146 10A032 500 10	C146 10B032 500 10	Contact insert 46+PE 	C146 10A046 500 10	C146 10B046 500 10

¹⁾ For versions without wire protection please refer C146 main catalog or www.amphenol.info

²⁾ For 48 pol version please refer C146 main catalog or www.amphenol.info

C 146 E / C 146 EE



Contacts¹⁾

Supplied as	for wire gauge	AWG	Pieces	Part No.	
				Male contact	Female contact
Stamped single contacts					
	0,5 - 1,5 mm ²	20 - 16	100	VN01 025 0001 (101)	VN02 025 0001 (101)
	1,5 - 2,5 mm ²	16 - 14	100	VN01 025 0010 (101)	VN02 025 0010 (101)
Stamped contacts on reel for hand crimp tools					
	0,5 - 1,5 mm ²	20 - 16	200	ZN01 025 0001 (1)	ZN02 025 0001 (1)
	1,5 - 2,5 mm ²	16 - 14	100	ZN01 025 0010 (1)	ZN02 025 0010 (1)
Stamped contacts on reel for crimp machines					
Contact feeding right hand side	0,5 - 1,5 mm ²	20 - 16	2000	HN01 025 0001 (1)	HN02 025 0001 (1)
	1,5 - 2,5 mm ²	16 - 14	2000	HN01 025 0010 (1)	HN02 025 0010 (1)
Contact feeding left hand side	0,5 - 1,5 mm ²	20 - 16	2000	TN01 025 0001 (1)	TN02 025 0001 (1)
	1,5 - 2,5 mm ²	16 - 14	2000	TN01 025 0010 (1)	TN02 025 0010 (1)
Turned crimp contacts					
Single contact	0,5 mm ²	20	100	VN01 025 0035 (1)C	VN02 025 0035 (1)C
	0,75 - 1,0 mm ²	18	100	VN01 025 0036 (1)C	VN02 025 0036 (1)C
	1,5 mm ²	16	100	VN01 025 0037 (1)C	VN02 025 0037 (1)C
	2,5 mm ²	14	100	VN01 025 0038 (1)C	VN02 025 0038 (1)C
	4,0 mm ²	12	100	VN01 025 0039 (1)C	VN02 025 0039 (1)C

¹⁾ For gold plated contacts please refer C146 main catalog or www.amphenol.info

C 146 A

Inserts



Description - Figure	Part No.		Description - Figure	Part No.	
	Male insert	Female insert		Male insert	Female insert
<i>Contact insert screw termination 3+PE</i> 	C146 10A003 002 4	C146 10B003 002 4	<i>Contact insert screw termination 4+PE</i> 	C146 10A004 002 4	C146 10B004 002 4
<i>Contact insert screw termination 10+PE</i> 	C146 10A010 102 4 ²⁾ (with wire protection)	C146 10B010 102 4 ²⁾ (with wire protection)	<i>Contact insert screw termination 16+PE ³⁾</i> 	C146 10A016 102 4 ²⁾ (with wire protection)	C146 10B016 102 4 ²⁾ (with wire protection)

²⁾ For versions without wire protection please refer C146 main catalog or www.amphenol.info

³⁾ For 32 pol versions please refer C146 main catalog or www.amphenol.info

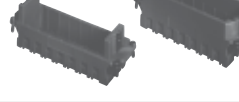

C 146 M

Frames

Description - Figure	Positions	Part No.	
		Frame for pin modules	Frame for socket module
Frame for 2 modules 	A - B	C146 P06 001 G8 C146 P06 002 G8 (2 x PE)	C146 S06 001 G8 C146 S06 002 G8 (2 x PE)
Frame for 3 modules 	A - C	C146 P10 001 G8 C146 P10 002 G8 (2 x PE)	C146 S10 001 G8 C146 S10 002 G8 (2 x PE)
Frame for 5 modules 	A - E	C146 P16 001 G8 C146 P16 002 G8 (2 x PE)	C146 S16 001 G8 C146 S16 002 G8 (2 x PE)
Frame for 7 modules 	A - G T - Z	C146 P24 001 G8 C146 P24 002 G8 (2 x PE) C146 P24 101 G8 C146 P24 102 G8 (2 x PE)	C146 S24 001 G8 C146 S24 002 G8 (2 x PE) C146 S24 101 G8 C146 S24 102 G8 (2 x PE)

C 146 M

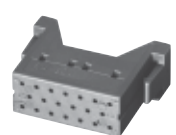
Modules Contacts

Description - Figure	Part No.		Part No.										
	pin module	socket module	Supplied as	for wire gauge	AWG	Pieces	Male contacts	Female contacts					
20 contacts for stamped contacts 	C146 A20 001 G8	C146 B20 001 G8	Single contacts for hand crimping tools						gold plating				
				0,09 - 0,25 mm ²	28-24	100	VN01 010 0130 (2)	VN02 010 0130 (2)					
				0,25 - 0,50 mm ²	24-20	100	VN01 010 0131 (2)	VN02 010 0131 (2)					
			Contacts on reel for hand crimping tools										
				0,09 - 0,25 mm ²	28-24	500	ZN01 010 0130 (2)	ZN02 010 0130 (2)					
				0,25 - 0,50 mm ²	24-20	500	ZN01 010 0131 (2)	ZN02 010 0131 (2)					
			Contacts on reel for crimp machines										
			Contact feeding left hand side ²⁾	0,09 - 0,25 mm ²	28-24	2000	TN01 010 0130 (2)	TN02 010 0130 (2)					
				0,25 - 0,50 mm ²	24-20	2000	TN01 010 0131 (2)	TN02 010 0131 (2)					
			10 contacts for stamped contacts 	C146 D10 001 E8	C146 C10 001 G8	Stamped single contacts						silver plating	
Standard	0,14 - 0,5 mm ²	26-20				100	VN01 016 0003 (1)	VN02 016 0003 (1)					
	0,5 - 1,5 mm ²	20-16				100	VN01 016 0002 (1)	VN02 016 0002 (1)					
	1,5 - 2,5 mm ²	16-14				100	VN01 016 0005 (1)	VN02 016 0005 (1)					
	High current	0,5 - 1,5 mm ²				20-16	100	VN01 016 0015 (1)	VN02 016 0015 (1)				
	1,5 - 2,5 mm ²	16-14				100	VN01 016 0016 (1)	VN02 016 0016 (1)					
Stamped contacts on reel for hand crimp tools						silver plating							
Standard	0,14 - 0,5 mm ²	26-20				200	ZN01 016 0003 (1)	ZN02 016 0003 (1)					
	0,5 - 1,5 mm ²	20-16				200	ZN01 016 0002 (1)	ZN02 016 0002 (1)					
	1,5 - 2,5 mm ²	16-14				100	ZN01 016 0005 (1)	ZN02 016 0005 (1)					
	High current	0,5 - 1,5 mm ²				20-16	200	ZN01 016 0015 (1)	ZN02 016 0015 (1)				
	1,5 - 2,5 mm ²	16-14				100	ZN01 016 0016 (1)	ZN02 016 0016 (1)					
Stamped contacts on reel for crimp machines						silver plating							
Contact feeding left hand side ²⁾	0,14 - 0,5 mm ²	26-20				2000	TN01 016 0003 (1)	TN02 016 0003 (1)					
	0,5 - 1,5 mm ²	20-16				2000	TN01 016 0002 (1)	TN02 016 0002 (1)					
Standard	1,5 - 2,5 mm ²	16-14				2000	TN01 016 0005 (1)	TN02 016 0005 (1)					
High current	0,5 - 1,5 mm ²	20-16				2000	TN01 016 0015 (1)	TN02 016 0015 (1)					
	1,5 - 2,5 mm ²	16-14				2000	TN01 016 0016 (1)	TN02 016 0016 (1)					
10 contacts for turned contacts 	C146 A10 001 E8	C146 B10 001 E8				Turned crimp contacts						silver plating	
						Single contact	0,14 - 0,37 mm ²	26-22	100	VN01 016 0024 (1)C	VN02 016 0024 (1)C		
			0,5 mm ²	20	100		VN01 016 0025 (1)C	VN02 016 0025 (1)C					
			0,75 - 1,0 mm ²	20-16	100		VN01 016 0026 (1)C	VN02 016 0026 (1)C					
			1,5 mm ²	16-15	100		VN01 016 0027 (1)C	VN02 016 0027 (1)C					
			2,5 mm ²	14	100		VN01 016 0028 (1)C	VN02 016 0028 (1)C					

Description - Figure	Part No.		Turned crimp contacts						silver plating	
	pin module	socket module	Supplied as	for wire gauge	AWG	Pieces	Male contacts	Female contacts		
5 contacts for turned contacts 	C146 A05 001 E8 ¹⁾	C146 B05 001 E8 ¹⁾	Single contact	0,5 mm ²	20	100	VN01 025 0029 (1)C	VN02 025 0029 (1)C		
				0,75 - 1,0 mm ²	18	100	VN01 025 0030 (1)C	VN02 025 0030 (1)C		
				1,5 mm ²	16	100	VN01 025 0031 (1)C	VN02 025 0031 (1)C		
				2,5 mm ²	14	100	VN01 025 0032 (1)C	VN02 025 0032 (1)C		
				4,0 mm ²	12	100	VN01 025 0033 (1)C	VN02 025 0033 (1)C		
3 contacts for turned contacts 	C146 A03 001 E8	C146 B03 001 E8	Single contact	Turned crimp contacts						
				1,5 mm ²	16	100	VN01 036 0004 (1)C	VN02 036 0004 (1)C		
				2,5 mm ²	14	100	VN01 036 0005 (1)C	VN02 036 0005 (1)C		
				4,0 mm ²	12	100	VN01 036 0001 (1)C	VN02 036 0001 (1)C		
				6,0 mm ²	10	100	VN01 036 0002 (1)C ¹⁾	VN02 036 0002 (1)C ¹⁾		
5 contacts for stamped contacts 	C146 D04 001 E8 (4 pol)	C146 C04 001 E8 (4 pol)		Stamped single contacts						
				0,5 - 1,5 mm ²	20-16	100	VN01 025 0001 (101)	VN02 025 0001 (101)		
				1,5 - 2,5 mm ²	16-14	100	VN01 025 0010 (101)	VN02 025 0010 (101)		
	C146 D05 001 E8 (4 + PE)	C146 C05 001 E8 (4 + PE)			Contacts on reel for hand crimping tools					
					0,5 - 1,5 mm ²	20-16	200	ZN01 025 0001 (1)	ZN02 025 0001 (1)	
	C146 D05 801 E8 (5 pol)	C146 C05 801 E8 (5 pol)			Contacts on reel for crimp machines					
					0,5 - 1,5 mm ²	20-16	2000	TN01 025 0001 (1)	TN02 025 0001 (1)	
	C146 D05 801 E8 (5 pol)	C146 C05 801 E8 (5 pol)		Contact feeding left hand side ²⁾	1,5 - 2,5 mm ²	16-14	2000	TN01 025 0010 (1)	TN02 025 0010 (1)	
					2,5 - 4,0 mm ²	12	2000	TN01 025 0043 (1)	TN02 025 0043 (1)	
3 contacts for coax contacts 	C146 A03 501 E8	C146 B03 501 E8	Single contact	Crimp contacts for cable size						
				RG 174, 179, 316		1	17 DM 537 401	17DM 537 421		
				RG 58		1	17 DM 537 405	17DM 537 425		
3 contacts for turned contacts 	C146 A03 801 E8	C146 B03 801 E8	Single contact	Turned crimp contacts						
				1,5 mm ²	16	100	VN01 036 0004 (1) C	VN02 036 0004 (1) C		
				2,5 mm ²	14	100	VN01 036 0005 (1) C	VN02 036 0005 (1) C		
				4,0 mm ²	12	100	VN01 036 0001 (1) C	VN02 036 0001 (1) C		
				6,0 mm ²	10	100	VN01 036 0002 (1) C	VN02 036 0002 (1) C		
<i>RJ module</i> 	C146 E12 001 E8	C146 F12 001 G8		Turned crimp contacts						
				0,14 - 0,37 mm ²	26-22	100	VN01 016 0024 (1) C	VN02 016 0024 (1) C		
				0,5 mm ²	20	100	VN01 016 0025 (1) C	VN02 016 0025 (1) C		
				0,75 - 1,0 mm ²	20-16	100	VN01 016 0026 (1) C	VN02 016 0026 (1) C		
				1,5 mm ²	16-15	100	VN01 016 0027 (1) C	VN02 016 0027 (1) C		
<i>Pneumatic module, 1 or 2 connections</i> 	C146 G01 014 G8 (2,5 mm)	C146 H01 034 G8 (2,5 mm)								
	C146 G01 024 G8 (4,0 mm)	C146 H01 044 G8 (4,0 mm)								
	C146 G02 014 G8 (2,5 mm)	C146 H02 034 G8 (2,5 mm)								
	C146 G02 024 G8 (4,0 mm)	C146 H02 044 G8 (4,0 mm)								

¹⁾ For gold plated contacts please refer C146 main catalog or www.amphenol.info.

²⁾ For right feeding contacts please refer C146 main catalog or www.amphenol.info.

C 146 D

Inserts

Description - Figure	Part No.		Description - Figure	Part No.	
	Male insert	Female insert		Male insert	Female insert
Contact insert 7+PE 	C146 10A007 000 2 (for stamped crimp contacts) C146 10A007 500 2 (for turned crimp contacts)	C146 10B007 000 2 (for stamped crimp contacts) C146 10B007 500 2 (for turned crimp contacts)	Contact insert 8 pol 	C146 10A008 000 2 (for stamped crimp contacts) C146 10A008 500 2 (for turned crimp contacts)	C146 10B008 000 2 (for stamped crimp contacts) C146 10B008 500 2 (for turned crimp contacts)
Contact insert 15+PE 	C146 10A015 000 2 (for stamped crimp contacts) C146 10A015 500 2 (for turned crimp contacts)	C146 10B015 000 2 (for stamped crimp contacts) C146 10B015 500 2 (for turned crimp contacts)	Contact insert 25+PE 	C146 10A025 000 2 (for stamped crimp contacts) C146 10A025 500 2 (for turned crimp contacts)	C146 10B025 000 2 (for stamped crimp contacts) C146 10B025 500 2 (for turned crimp contacts)
Contact insert 40+PE 	C146 10A040 000 2 (for stamped crimp contacts) C146 10A040 500 2 (for turned crimp contacts)	C146 10B040 000 2 (for stamped crimp contacts) C146 10B040 500 2 (for turned crimp contacts)	Contact insert 64+PE 	C146 10A064 000 2 (for stamped crimp contacts) C146 10A064 500 2 (for turned crimp contacts)	C146 10B064 000 2 (for stamped crimp contacts) C146 10B064 500 2 (for turned crimp contacts)

C 146 DD

Inserts

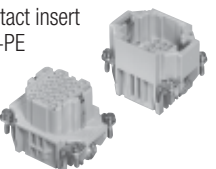
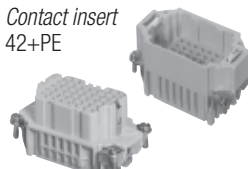
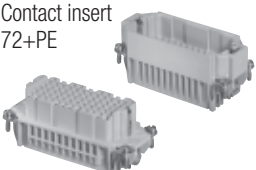
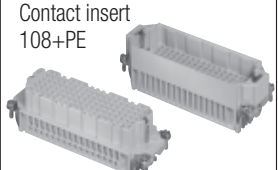
Description - Figure	Part No.		Description - Figure	Part No.	
	Male insert	Female insert		Male insert	Female insert
Contact insert 24+PE 	C146 10A024 000 9 (for turned crimp contacts)	C146 10B024 000 9 (for turned crimp contacts)	Contact insert 42+PE 	C146 10A042 000 9 (for turned crimp contacts)	C146 10B042 000 9 (for turned crimp contacts)
Contact insert 72+PE 	C146 10A072 000 9 (for turned crimp contacts)	C146 10B072 000 9 (for turned crimp contacts)	Contact insert 108+PE 	C146 10A108 000 9 (for turned crimp contacts)	C146 10B108 000 9 (for turned crimp contacts)

C 146 D / C 146 DD



Contacts⁴⁾

Supplied as	for wire gauge	AWG	Pieces	Part No.	
				Male contact	Female contact
Stamped single contacts					
Standard High current	0,14 - 0,5 mm ²	26 - 20	100	VN01 016 0003 (1)	VN02 016 0003 (1)
	0,5 - 1,5 mm ²	20 - 16	100	VN01 016 0002 (1)	VN02 016 0002 (1)
	1,5 - 2,5 mm ²	16 - 14	100	VN01 016 0005 (1)	VN02 016 0005 (1)
	0,5 - 1,5 mm ²	20 - 16	100	VN01 016 0015 (1)	VN02 016 0015 (1)
	1,5 - 2,5 mm ²	16 - 14	100	VN01 016 0016 (1)	VN02 016 0016 (1)

¹⁾ For versions with two PE contacts please refer C146 main catalog or www.amphenol.info

²⁾ For 50 pol versions please refer C146 main catalog or www.amphenol.info

³⁾ For 128 pol versions please refer C146 main catalog or www.amphenol.info

⁴⁾ For gold plated contacts please refer C146 main catalog or www.amphenol.info

C 146 D / C 146 DD



Contacts¹⁾

Supplied as	for wire gauge	AWG	Pieces	Part No.	
				Male contact	Female contact
Stamped Contacts on reel for hand crimp machines					
Contact feeding left hand side	0,14 - 0,5 mm ²	26 - 20	2000	TN01 016 0003 (1)	TN02 016 0003 (1)
	0,5 - 1,5 mm ²	20 - 16	2000	TN01 016 0002 (1)	TN02 016 0002 (1)
	Standard 1,5 - 2,5 mm ²	16 - 14	2000	TN01 016 0005 (1)	TN02 016 0005 (1)
	High current 0,5 - 1,5 mm ²	20 - 16	2000	TN01 016 0015 (1)	TN02 016 0015 (1)
	1,5 - 2,5 mm ²	16 - 14	2000	TN01 016 0016 (1)	TN02 016 0016 (1)
Stamped Contacts on reel for hand crimp tools					
Standard	0,14 - 0,5 mm ²	26 - 20	200	ZN01 016 0003 (1)	ZN02 016 0003 (1)
	0,5 - 1,5 mm ²	20 - 16	200	ZN01 016 0002 (1)	ZN02 016 0002 (1)
	1,5 - 2,5 mm ²	16 - 14	100	ZN01 016 0005 (1)	ZN02 016 0005 (1)
	High current 0,5 - 1,5 mm ²	20 - 16	200	ZN01 016 0015 (1)	ZN02 016 0015 (1)
	1,5 - 2,5 mm ²	16 - 14	100	ZN01 016 0016 (1)	ZN02 016 0016 (1)
Turned crimp contacts					
Single contact	0,14 - 0,37 mm ²	26 - 22	100	VN01 016 0024 (1)	VN02 016 0024 (1)
	0,5 mm ²	20	100	VN01 016 0025 (1)	VN02 016 0025 (1)
	0,75 - 1,0 mm ²	20 - 16	100	VN01 016 0026 (1)	VN02 016 0026 (1)
	1,5 mm ²	16 - 15	100	VN01 016 0027 (1)	VN02 016 0027 (1)
	2,5 mm ²	14	100	VN01 016 0028 (1)	VN02 016 0028 (1)

¹⁾ For gold plated contacts please refer C146 main catalog or www.amphenol.info

IP 68 Housings

General Characteristics		Standard		Value	
Degree of protection housing		IEC 60529		IP68	
Degree of protection cover		IEC 60529		IP68	
Locking System				2 screws	
Climatical Characteristics					
Climatic category		IEC 60068 - 1		40/100/21	
Temperature range		IEC 60068 - 1		-40°C/+100°C	
Materials					
Housing				Aluminium die cast alloy	
Protective cover				Aluminium die cast alloy	
Rubber gasket				Conductive neoprene	
Locking screws				Stainless steel	
Surface				Special surface	
		C 146 E 6 pol. C 146 M 2 Module C 146 DD 24 pol. C 146 EE 10 pol.		C 146 E 10 pol. C 146 M 3 Module C 146 DD 42 pol. C 146 EE 18 pol.	
	Side entry	M	25	C146 68R006 556 8	
	Top entry			C146 68R006 656 8	
				C146 68F006 001 1	
	Side entry	M	32	C146 68R010 506 8	C146 68R016 506 8
	Top entry			C146 68R010 606 8	C146 68R016 606 8
				C146 68F010 001 1	C146 68F016 001 1
	Side entry	M	40		C146 68R024 507 8
	Top entry				C146 68R024 607 8
					C146 68F024 001 1

Information: 1) All housings without stud 2) For dimensions please request drawings 3) bulkhead housings with cable outlets available upon request

IP 65 Housings

General Characteristics		Standard			Value														
Degree of protection housing		IEC 60529			IP65														
Degree of protection cover		IEC 60529			IP65														
Locking System					locking lever														
Climatical Characteristics																			
Climatic category		IEC 60068-1			40/100/21														
Temperature range		IEC 60068-1			-40°C/+100°C														
Materials																			
Housing					Aluminium die cast alloy														
Protective cover					Aluminium die cast alloy														
Rubber gasket					NBR, CR														
Locking lever					steel/zinc coated														
		C 146 E 6 pol. C 146 M 2 Module C 146 DD 24 pol. C 146 EE 10 pol.	L length in mm	B width in mm	H height in mm	C 146 E 10 pol. C 146 M 3 Module C 146 DD 42 pol. C 146 HvE 3 pol. C 146 EE 18 pol.	L length in mm	B width in mm	H height in mm	C 146 E 16 pol. C 146 M 5 Module C 146 D 40 pol. C 146 DD 72 pol. C 146 HSE 6pol. C 146 EE 32 pol.	L length in mm	B width in mm	H height in mm	C 146 E 24 pol. C 146 M 7 Module C 146 D 64 pol. C 146 DD 108 pol. C 146 HvE 10 pol. C 146 EE 46 pol.	L length in mm	B width in mm	H height in mm		
Hood, top entry	Low profile	PG	16			C146 10G010 600 1	73,0	43	51,0										
			21			C146 10G010 601 1	73,0	43	51,0	C146 10G016 600 1	93,5	43	62,0	C146 10G024 600 1	120	43	62,0		
			29							C146 10G016 601 1	93,5	43	62,0	C146 10G024 601 1	120	43	62,0		
			M	20			C146 21R010 650 1	73,0	43	51,0									
			25			C146 21R010 600 1	73,0	43	51,0	C146 21R016 650 1	93,5	43	62,0	C146 21R024 650 1	120	43	62,0		
			32							C146 21R016 600 1	93,5	43	62,0	C146 21R024 600 1	120	43	62,0		
Hood, top entry	High profile	PG	16			C146 10G010 650 8	73,0	43	70,0										
			21			C146 10G010 600 8	73,0	43	70,0	C146 10G016 600 8	93,5	43	76,0	C146 10G024 600 8	120	43	76,0		
			29			C146 10G010 601 8	73,0	43	70,0	C146 10G016 601 8	93,5	43	76,0	C146 10G024 601 8	120	43	76,0		
			M	25			C146 21R010 650 8	73,0	43	70,0	C146 21R016 650 8	93,5	43	76,0	C146 21R024 650 8	120	43	76,0	
			32			C146 21R010 600 8	73,0	43	70,0	C146 21R016 600 8	93,5	43	76,0	C146 21R024 600 8	120	43	76,0		
			40			C146 21R010 601 8	73,0	43	70,0	C146 21R016 601 8	93,5	43	76,0	C146 21R024 601 8	120	43	76,0		
Hood, side entry	Low profile	PG	16			C146 10G010 500 1	73,0	43	51,0										
			21			C146 10G010 501 1	73,0	43	51,0	C146 10G016 500 1	93,5	43	62,0	C146 10G024 500 1	120	43	62,0		
			29							C146 10G016 501 1	93,5	43	62,0	C146 10G024 501 1	120	43	62,0		
			M	20			C146 21R010 550 1	73,0	43	51,0									
			25			C146 21R010 500 1	73,0	43	51,0	C146 21R016 550 1	93,5	43	62,0	C146 21R024 550 1	120	43	62,0		
			32							C146 21R016 500 1	93,5	43	62,0	C146 21R024 500 1	120	43	62,0		
Hood, side entry	High profile	PG	16			C146 10G010 550 8	73,0	43	70,0										
			21			C146 10G010 500 8	73,0	43	70,0	C146 10G016 500 8	93,5	43	76,0	C146 10G024 500 8	120	43	76,0		
			29			C146 10G010 501 8	73,0	43	70,0	C146 10G016 501 8	93,5	43	76,0	C146 10G024 501 8	120	43	76,0		
			M	25			C146 21R010 550 8	73,0	43	70,0	C146 21R016 550 8	93,5	43	76,0	C146 21R024 550 8	120	43	76,0	
			32			C146 21R010 500 8	73,0	43	70,0	C146 21R016 500 8	93,5	43	76,0	C146 21R024 500 8	120	43	76,0		
			40							C146 21R016 501 8	93,5	43	76,0	C146 21R024 501 8	120	43	76,0		
Housing, bulkhead mounting						C146 10F010 000 1	93,0	32	28,5	C146 10F016 000 1	113,0	32	28,5	C146 10F024 000 1	140	32	28,5		
Hood, top entry	Low profile	PG	13,5	C146 10G006 600 1	60,0	43	51,0												
			16	C146 10G006 601 1	60,0	43	51,0	C146 10G010 601 1	73,0	43	51,0								
			21							C146 10G016 606 1	93,5	43	62,0	C146 10G024 606 1	120	43	62,0		
			29							C146 10G016 607 1	93,5	43	62,0	C146 10G024 607 1	120	43	62,0		
Hood, top entry	High profile	PG	16	C146 21R006 656 1	60,0	43	51,0												
			20	C146 21R006 606 1	60,0	43	51,0	C146 21R010 656 1	73,0	43	51,0								
			25	C146 21R006 607 1	60,0	43	51,0	C146 21R010 606 1	73,0	43	51,0	C146 21R016 656 1	93,5	43	62,0	C146 21R024 656 1	120	43	62,0
			32							C146 21R016 606 1	93,5	43	62,0	C146 21R024 606 1	120	43	62,0		
Hood, top entry	High profile	PG	16	C146 10G006 656 8	60,0	43	70,0												
			21	C146 10G006 606 8	60,0	43	70,0	C146 10G010 606 8	73,0	43	70,0	C146 10G016 606 8	93,5	43	76,0	C146 10G024 606 8	120	43	76,0
			29	C146 10G006 607 8	60,0	43	70,0	C146 10G010 607 8	73,0	43	70,0	C146 10G016 607 8	93,5	43	76,0	C146 10G024 607 8	120	43	76,0
			M	25	C146 21R006 656 8	60,0	43	70,0	C146 21R010 656 8	73,0	43	70,0	C146 21R016 656 8	93,5	43	76,0	C146 21R024 656 8	120	43
			32	C146 21R006 606 8	60,0	43	70,0	C146 21R010 606 8	73,0	43	70,0	C146 21R016 606 8	93,5	43	76,0	C146 21R024 606 8	120	43	76,0
			40							C146 21R016 607 8	93,5	43	76,0	C146 21R024 607 8	120	43	76,0		

Information: 1) PG housings with stud 2) Metric housings without stud 3) EMI housings are also available
 4) For dimensions and panel cut outs please refer C146 main catalog and www.amphenol.info
 5) For bulk head mounting housings with cable outlet, coupling housings and housings with cover please refer C146 main catalog and www.amphenol.info
 6) Housings with more than one cable outlet are available upon request

Kits C146 E

Screw Termination

Kits consist of insert with contacts, housing and gland bushing for housings with cable outlet

No. of Pos.	PG	Part No.	Component parts	Cable entry	Hood profile	Spring cover
6 POL  	16	C146 10E006 943 1	C146 10G006 501 1 C146 10A006 102 1 VN16 160 0014	side	low	
		C146 10E006 944 1	C146 10G006 601 1 C146 10A006 102 1 VN16 160 0014	top	low	
	21	C146 10E006 945 8	C146 10G006 506 8 C146 10A006 102 1 VN16 160 0014	side	high	
		C146 10E006 946 8	C146 10G006 606 8 C146 10A006 102 1 VN16 160 0014	top	high	
	panel	C146 10E006 940 1	C146 10F006 000 1 C146 10B006 102 1			no
		C146 10E006 942 1	C146 10F006 003 1 C146 10B006 102 1			yes
10 POL  	21	C146 10E010 943 1	C146 10G010 506 1 C146 10A010 102 1 VN16 160 0014	side	low	
		C146 10E010 944 1	C146 10G010 606 1 C146 10A010 102 1 VN16 160 0014	top	low	
		C146 10E010 945 1	C146 10G010 607 1 C146 10A010 102 1 VN16 160 0014	top	low	
		C146 10E010 946 1	C146 10G010 507 1 C146 10A010 102 1 VN16 160 0014	side	low	
	panel	C146 10E010 941 1	C146 10F010 001 1 C146 10B010 102 1			no
		C146 10E010 942 1	C146 10F010 003 1 C146 10B010 102 1			yes
16 POL  	21	C146 10E016 943 1	C146 10G016 506 1 C146 10A016 102 1 VN16 160 0014	side	low	
		C146 10E016 944 1	C146 10G016 606 1 C146 10A016 102 1 VN16 160 0014	top	low	
	panel	C146 10E016 941 1	C146 10F016 001 1 C146 10B016 102 1			no
		C146 10E016 942 1	C146 10F016 003 1 C146 10B016 102 1			yes

Kits C146 E

Screw Termination

Kits consist of insert with contacts, housing and gland bushing for housings with cable outlet

No. of Pos.	PG	Part No.	Component parts	Cable entry	Hood profile	Spring cover
24 POL  	21	C146 10E024 943 8	C146 10G024 500 8 C146 10A024 102 1 VN16 210 0014	side	high	
		C146 10E024 944 8	C146 10G024 600 8 C146 10A024 102 1 VN16 210 0014	top	high	
		C146 10E024 945 1	C146 10G024 500 1 C146 10A024 102 1 VN16 210 0014	side	low	
		C146 10E024 946 1	C146 10G024 600 1 C146 10A024 102 1 VN16 210 0014	top	low	
		C146 10E024 947 8	C146 10G024 506 8 C146 10A024 102 1 VN16 210 0014	side	high	
		C146 10E024 948 8	C146 10G024 606 8 C146 10A024 102 1 VN16 210 0014	top	high	
		C146 10E024 949 1	C146 10G024 506 1 C146 10A024 102 1 VN16 210 0014	side	low	
		C146 10E024 950 1	C146 10G024 606 1 C146 10A024 102 1 VN16 210 0014	top	low	
	29	C146 10E024 951 8	C146 10G024 501 8 C146 10A024 102 1 VN16 210 0014	side	high	
		C146 10E024 952 8	C146 10G024 601 8 C146 10A024 102 1 VN16 210 0014	top	high	
		C146 10E024 953 1	C146 10G024 501 1 C146 10A024 102 1 VN16 210 0014	side	low	
		C146 10E024 954 1	C146 10G024 601 1 C146 10A024 102 1 VN16 210 0014	top	low	
		C146 10E024 955 1	C146 10G024 507 1 C146 10A024 102 1 VN16 210 0014	side	low	
		C146 10E024 956 8	C146 10G024 507 8 C146 10A024 102 1 VN16 210 0014	side	high	
		C146 10E024 957 8	C146 10G024 607 8 C146 10A024 102 1 VN16 210 0014	top	high	
		C146 10E024 958 1	C146 10G024 607 1 C146 10A024 102 1 VN16 210 0014	top	low	
	panel	C146 10E024 940 1	C146 10F024 000 1 C146 10B024 102 1			no
		C146 10E024 941 1	C146 10F024 001 1 C146 10B024 102 1			no
		C146 10E024 942 1	C146 10F024 003 1 C146 10B024 102 1			yes

Gland bushings

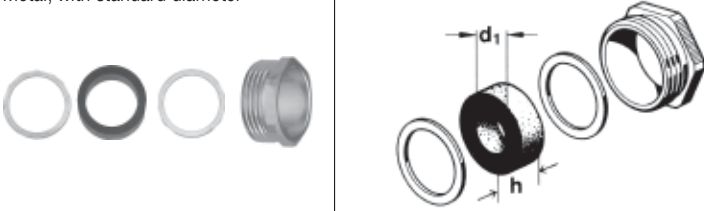

Gland bushings IP 65	Drawing	PG	M	Pieces	Part No.
Metal, with variable inner diameter 		11		10	VN16 110 0014 X (Thermoplast)
			20	10	VN16 200 0114 X (Thermoplast)
		13,5		10	VN16 135 0014 X
		16		10	VN16 160 0014 X
			20	10	VN16 200 0114 X
		21		10	VN16 210 0014 X
			25	10	VN16 250 0114 X
		29		10	VN16 290 0014 X
			32	10	VN16 320 0114 X
		36		10	VN16 360 0014 X
			40	10	VN16 400 0114 X
		42		10	VN16 420 0014 X
			50	10	VN16 500 0114 X
Metal, with standard diameter 		11		10	VN16 110 0013 X (Thermoplast)
		13,5		10	VN16 135 0013 X
		16		10	VN16 160 0013 X
		21		10	VN16 210 0013 X
		29		10	VN16 290 0013 X
		36		10	VN16 360 0013 X
		42		10	VN16 420 0013 X

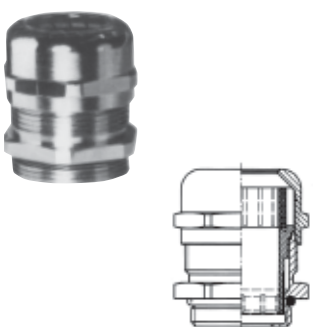
Gland bushing with vibration protection IP 67	Clamping range Ø	A (mm)	PG	M	Pieces	Part No.
	4 - 10 mm	24,4	11		10	VN16 110 0027 X
	4 - 10 mm	20		16	10	VN16 160 0127 X
	5 - 12 mm	26,5	13,5		10	VN16 135 0027 X
	6 - 12 mm	24		20	10	VN16 200 0127 X
	9 - 14 mm	29,5	16		10	VN16 160 0027 X
	9 - 16 mm	28		25	10	VN16 250 0127 X
	13 - 18 mm	36,2	21		10	VN16 210 0027 X
	10 - 21 mm	36		32	10	VN16 320 0127 X
	14 - 25 mm	43,6	29		10	VN16 290 0027 X
16 - 28 mm	46		40	10	VN16 400 0127 X	

Gland bushing EMC IP 68	Clamping range Ø	PG	M	Pieces	Part No.
	4 - 10 mm	11		10	VN16 110 0026 X
	5,5 - 10 mm		16	10	VN16 160 0126 X
	5 - 12 mm	13,5		10	VN16 135 0026 X
	8 - 13 mm		20	10	VN16 200 0126 X
	8 - 14 mm	16		10	VN16 160 0026 X
	11 - 18 mm		25	10	VN16 250 0126 X
	11 - 17,5 mm	21		10	VN16 210 0026 X
	15 - 21 mm		32	10	VN16 320 0126 X
	16 - 25 mm	29		10	VN16 290 0026 X
19 - 27 mm		40	10	VN16 400 0126 X	

Crimping tools for stamped contacts



Description	for wire gauge	Part No.		
		Contact locator	Crimping dies	Tools
Removal tool for contacts 	–	–	–	FG 0300 146 1
Service crimping tool Crimping tool for single contacts  	0,14 - 0,5 mm ² 0,5 - 1,5 mm ²	–	–	TA 0100 146
	0,14 - 0,5 mm ² 0,5 - 1,5 mm ² 1,5 - 2,5 mm ²	TA 0001 146 000 1 TA 0002 146 000 1 TA 0007 146 000 3	TA 0000 202 TA 0000 163 TA 0000 141	TA 0000 TA 0500

¹⁾ Further information see catalogue „Tools“

Hand crimping tool for turned contacts



Description	Contact Ø	for wire gauge	Part No.
incl. contact locator and calibration pin  4-Indent hand crimping tool for turned contacts  	1,0 mm	0,10 - 0,5 mm ²	TB 0300 146
	1,6 mm	0,14 - 2,5 mm ²	TB 0400 146
	2,5 mm (with clip)	0,5 - 4 mm ²	TB 0100 146
	2,5 mm (without clip)	0,5 - 4 mm ²	TB 0600 146
	3,6 mm (with clip)	1,5 - 10 mm ²	TB 0200 146
	3,6 mm (without clip)	1,5 - 10 mm ²	TB 0100 148
	1,6 mm LWL		TB 0500 146

International

Argentina

Amphenol Argentina
Av. Callao 930
2nd Floor Office B "Plaza"
C 1023 AAP Buenos Aires
Phone +54 / 11 / 48156886
Fax +54 / 11 / 48145779

Australia

Amphenol Australia Ltd.
2 Fiveways Blvd
Keysborough
Victoria 31 73
Phone +61 / 3 / 8796 / 8888
Fax +61 / 3 / 8796 / 8801

Belgium

Amphenol-Tuchel Belgium
Brusselbaan 524b
B 1600 Sint-Pieters-Leeuw
Phone +32 / 2377 / 2549
Fax +32 / 2377 / 5303

Brasilia

Amphenol do Brasil Ltda.
Rua Diogo Moreira 132, 20th Floor
CEP 05423-010 Sao Paulo SP
Phone +55 / 11 / 3815.1003
Fax +55 / 11 / 3815.1629

China

Amphenol-Tuchel Electronics GmbH
China Branch
210-1 Taishan Road
Changzhou 213022
Phone +86 / 0519 / 5110301
Fax +86 / 0519 / 5110299

France

Amphenol-Tuchel France
Villa Parc
Allée Lesch Vallesse
Immeuble le Cèdre
F-77185 Lognes
Tel. +33 / 164627676
Fax +33 / 164627677

Germany

Amphenol-Tuchel Electronics GmbH
August-Haeusser-Str. 10
74080 Heilbronn
Phone +49 / 7131 / 929-0
Fax +49 / 7131 / 929-486

Great Britain

Amphenol-Tuchel Great Britain
PO Box 6766
Basingstoke
RG24 4JG
Phone +44 / 1256 / 330749
Fax +44 / 1256 / 330749

Hong Kong

Amphenol East Asia Limited
Units 2201-02, Railway Plaza
39 Chatham Road South
Tsimshatsui, Kowloon
Phone +852 / 2699 / 2663
Fax +852 / 2688 / 0974

India

Amphetrnix Limited
Plot No. 105 Bhosari Industrial Area
Pune - 411 026
Phone +91 / 20 / 27121418
Fax +91 / 20 / 27120581

Italy

Amphenol-Tuchel Italy
Via Barbaiana n. 5
I-20020 Lainate (MI)
Phone +39 / 2 / 932 541
Fax +39 / 2 / 932 54444

Japan

Amphenol Japan, K.K.
2-3-27, Kudan Minami
Chiyoda-Ku
Tokyo 102
Phone +81 / 3 / 3263 / 5611
Fax +81 / 3 / 5276 / 7059

Korea

Amphenol DaeShin Limited
558 Songnae-Dong, Sosa-Gu
Bucheon-City, Kyunggi-Do
Korea 422-040
Phone +82 / 2 / 785 / 1588
Fax +82 / 2 / 589 / 1514

Mexico

Amphenol Mexico
Prolongacion Reforma 61 - 6 B2
Col. Paseo de las Lomas
C.P. 01330 Mexico D.F.
Phone +52 / 55 / 5258.9984
Fax +52 / 55 / 5081.6890

Singapore

Amphenol East Asia Limited
Asia Pacific Sales Operation
Singapore Branch
300 Beach Road
#25-07 The Concourse
Singapore 199555
Phone +27 / 11 / 305-9574
Fax +27 / 11 / 305-9576

South Africa

Amphenol International Ltd
Chislehurst
30 Impala Road
Chislehurst
Sandton, 2146
Phone +27 / 11 / 7839517
Fax +27 / 11 / 7839519

Spain

Amphenol-Tuchel Spain
Ctra Sabadell a Mollet,
km 4.5 Nave 5
08130 Santa Perpetua de
Mogoda (Barcelona)
Phone +34 / 93 / 574.41.34
Fax +34 / 93 / 574.10.09

Sweden

Amphenol-Tuchel Scandinavia
P.O. Box 20
SE 195 42 Märsta
Phone +46 / 8 591 / 175 76
Fax +46 / 8 591 / 175 76

Taiwan

Amphenol East Asia Ltd.
Taiwan Branch (H.K.)
116 Zhong Shan Road
Lane 956 Taoyuan City
Taiwan R.O.C. 330
Phone +886 / 3 / 370 / 7855
Fax +886 / 3 / 360 / 7259

Turkey

Amphenol Turkiye
Ayazaga Mah. Meydan Sk. No. 28
Beybi Giz Plaza, Kat. 26
34396 Maslak/Istanbul
Phone +90 / 0212 / 3352501
Fax +90 / 0212 / 3352500

USA

Amphenol-Tuchel Electronics
6900 Haggerty Road
Suite 200
Canton, Michigan 48187
Phone +1 / 734 / 4516400
Fax +1 / 734 / 451 7197

Amphenol Corporation
Corporate Headquarters
358 Hall Avenue
Wallingford, CT 06492
Phone +1 / 800 / 380 8052
Phone +1 / 203 / 265 / 8900
Fax +1 / 203 / 265 / 8628

Your engineering sales representative:

Amphenol

Amphenol-Tuchel Electronics GmbH

August-Haeusser-Str. 10 • D-74080 Heilbronn • Germany • Phone +49 (0) 7131/929-0 • Fax +49 (0) 7131/929-486 • www.amphenol.info

Компания «Океан Электроники» предлагает заключение долгосрочных отношений при поставках импортных электронных компонентов на взаимовыгодных условиях!

Наши преимущества:

- Поставка оригинальных импортных электронных компонентов напрямую с производств Америки, Европы и Азии, а так же с крупнейших складов мира;
- Широкая линейка поставок активных и пассивных импортных электронных компонентов (более 30 млн. наименований);
- Поставка сложных, дефицитных, либо снятых с производства позиций;
- Оперативные сроки поставки под заказ (от 5 рабочих дней);
- Экспресс доставка в любую точку России;
- Помощь Конструкторского Отдела и консультации квалифицированных инженеров;
- Техническая поддержка проекта, помощь в подборе аналогов, поставка прототипов;
- Поставка электронных компонентов под контролем ВП;
- Система менеджмента качества сертифицирована по Международному стандарту ISO 9001;
- При необходимости вся продукция военного и аэрокосмического назначения проходит испытания и сертификацию в лаборатории (по согласованию с заказчиком);
- Поставка специализированных компонентов военного и аэрокосмического уровня качества (Xilinx, Altera, Analog Devices, Intersil, Interpoint, Microsemi, Actel, Aeroflex, Peregrine, VPT, Syfer, Eurofarad, Texas Instruments, MS Kennedy, Miteq, Cobham, E2V, MA-COM, Hittite, Mini-Circuits, General Dynamics и др.);

Компания «Океан Электроники» является официальным дистрибьютором и эксклюзивным представителем в России одного из крупнейших производителей разъемов военного и аэрокосмического назначения «JONHON», а так же официальным дистрибьютором и эксклюзивным представителем в России производителя высокотехнологичных и надежных решений для передачи СВЧ сигналов «FORSTAR».



JONHON

«JONHON» (основан в 1970 г.)

Разъемы специального, военного и аэрокосмического назначения:

(Применяются в военной, авиационной, аэрокосмической, морской, железнодорожной, горно- и нефтедобывающей отраслях промышленности)

«FORSTAR» (основан в 1998 г.)

ВЧ соединители, коаксиальные кабели, кабельные сборки и микроволновые компоненты:

(Применяются в телекоммуникациях гражданского и специального назначения, в средствах связи, РЛС, а так же военной, авиационной и аэрокосмической отраслях промышленности).



Телефон: 8 (812) 309-75-97 (многоканальный)

Факс: 8 (812) 320-03-32

Электронная почта: ocean@oceanchips.ru

Web: <http://oceanchips.ru/>

Адрес: 198099, г. Санкт-Петербург, ул. Калинина, д. 2, корп. 4, лит. А