

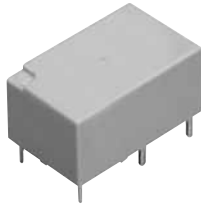

### 1a 10A, 1a1b/2a 8A small polarized power relays

## DK RELAYS



RoHS compliant

Protective construction: Sealed type

### FEATURES

- 1. Compact with high capacity**  
High capacity switching in a small package: 1 Form A, 10 A 250 V AC; 1 Form A 1 Form B and 2 Form A, 8 A 250 V AC.
- 2. High sensitivity: 200 mW nominal operating power**
- 3. High breakdown voltage**  
Independent coil and the contact structure improves breakdown voltage.

Between contact and coil	Between open contacts
4,000 Vrms for 1 min. 10,000 V surge breakdown voltage	1,000 Vrms for 1 min. 1,500 V surge breakdown voltage

Conforms with FCC Part 68

- 4. Latching types available**
- 5. Sealed construction allows automatic washing**
- 6. Sockets are available**
- 7. Complies with safety standards**  
Complies with Japan Electrical Appliance and Material Safety Law requirements for operating 200 V power supply circuits, and complies with UL, CSA, and TÜV safety standards.

### TYPICAL APPLICATIONS

1. Switching power supply
2. Power switching for various OA equipment
3. Control or driving relays for industrial machines (robotics, numerical control machines, etc.)
4. Output relays for programmable logic controllers, temperature controllers, timers and so on
5. Home appliances

### ORDERING INFORMATION

DK  -  -  -

Contact arrangement

- 1a: 1 Form A  
2a: 2 Form A  
1a1b: 1 Form A 1 Form B

Operating function

- Nil: Single side stable  
L2: 2 coil latching

Nominal coil voltage (DC)

- 3, 5, 6, 9, 12, 24V

Contact material

- F: 1 Form A (Au-flashed AgSnO<sub>2</sub> type)  
Nil: 2 Form A, 1 Form A 1 Form B (Au-flashed AgNi type)

Note: VDE approved type is available.

## TYPES

Contact arrangement	Nominal coil voltage	Single side stable		2 coil latching	
		Part No.		Part No.	
1 Form A	3V DC	DK1a-3V-F		DK1a-L2-3V-F	
	5V DC	DK1a-5V-F		DK1a-L2-5V-F	
	6V DC	DK1a-6V-F		DK1a-L2-6V-F	
	9V DC	DK1a-9V-F		DK1a-L2-9V-F	
	12V DC	DK1a-12V-F		DK1a-L2-12V-F	
	24V DC	DK1a-24V-F		DK1a-L2-24V-F	
1 Form A 1 Form B	3V DC	DK1a1b-3V		DK1a1b-L2-3V	
	5V DC	DK1a1b-5V		DK1a1b-L2-5V	
	6V DC	DK1a1b-6V		DK1a1b-L2-6V	
	9V DC	DK1a1b-9V		DK1a1b-L2-9V	
	12V DC	DK1a1b-12V		DK1a1b-L2-12V	
	24V DC	DK1a1b-24V		DK1a1b-L2-24V	
2 Form A	3V DC	DK2a-3V		DK2a-L2-3V	
	5V DC	DK2a-5V		DK2a-L2-5V	
	6V DC	DK2a-6V		DK2a-L2-6V	
	9V DC	DK2a-9V		DK2a-L2-9V	
	12V DC	DK2a-12V		DK2a-L2-12V	
	24V DC	DK2a-24V		DK2a-L2-24V	

Standard packing: Carton: 50 pcs.; Case: 500 pcs.

\* Sockets available.

## RATING

### 1. Coil data

#### 1) Single side stable

Nominal coil voltage	Pick-up voltage (at 20°C 68°F)	Drop-out voltage (at 20°C 68°F)	Nominal operating current [±10%] (at 20°C 68°F)		Coil resistance [±10%] (at 20°C 68°F)	Nominal operating power	Max. applied voltage (at 20°C 68°F)
3V DC	70%V or less of nominal voltage (Initial)	10%V or more of nominal voltage (Initial)	66.6mA		45Ω	200mW	130%V of nominal voltage
5V DC			40mA		125Ω		
6V DC			33.3mA		180Ω		
9V DC			22.2mA		405Ω		
12V DC			16.6mA		720Ω		
24V DC			8.3mA		2,880Ω		

#### 2) 2 coil latching

Nominal coil voltage	Set voltage (at 20°C 68°F)	Reset voltage (at 20°C 68°F)	Nominal operating current [±10%] (at 20°C 68°F)		Coil resistance [±10%] (at 20°C 68°F)		Nominal operating power		Max. applied voltage (at 20°C 68°F)
			Set coil	Reset coil	Set coil	Reset coil	Set coil	Reset coil	
3V DC	70%V or less of nominal voltage (Initial)	70%V or less of nominal voltage (Initial)	66.6mA	66.6mA	45Ω	45Ω	200mW	200mW	130%V of nominal voltage
5V DC			40mA	40mA	125Ω	125Ω			
6V DC			33.3mA	33.3mA	180Ω	180Ω			
9V DC			22.2mA	22.2mA	405Ω	405Ω			
12V DC			16.6mA	16.6mA	720Ω	720Ω			
24V DC			8.3mA	8.3mA	2,880Ω	2,880Ω			

**2. Specifications**

Characteristics	Item	Specifications		
		1 Form A	1 Form A 1 Form B	2 Form A
Contact	Arrangement	1 Form A	1 Form A 1 Form B	2 Form A
	Contact resistance (Initial)	Max. 30 mΩ (By voltage drop 6 V DC 1A)		
	Contact material	Au-flashed AgSnO <sub>2</sub> type / Au-flashed AgNi type		
Rating	Nominal switching capacity (resistive load)	10 A 250 V AC, 10 A 30 V DC	8 A 250 V AC, 8 A 30 V DC	8 A 250 V AC, 8 A 30 V DC
	Max. switching power (resistive load)	2,500VA, 300 W	2,000 VA, 240 W	2,000 VA, 240 W
	Max. switching voltage	250 V AC, 125 V DC (0.2A)	250 V AC, 125 V DC (0.2A)	250 V AC, 125 V DC (0.2A)
	Max. switching current	10 A	8 A	8 A
	Min. switching capacity (Reference value)*1	10m A 5 V DC		
Electrical characteristics	Insulation resistance (Initial)	Min. 1,000MΩ (at 500V DC) Measurement at same location as "Breakdown voltage" section.		
	Breakdown voltage (Initial)	Between open contacts	1,000 Vrms for 1min. (Detection current: 10mA.)	
		Between contact and coil	4,000 Vrms for 1min. (Detection current: 10mA.)	
	Surge breakdown voltage*2 (Initial)	between contacts and coil	10,000 V	
	Operate time [Set time] (at 20°C 68°F)	Max. 10 ms (Approx. 5 ms) [10 ms (Approx. 5 ms)] (Nominal coil voltage applied to the coil, excluding contact bounce time.)		
Release time [Reset time] (at 20°C 68°F)	Max. 8 ms (Approx. 3 ms) [10 ms (Approx. 3 ms)] (Nominal coil voltage applied to the coil, excluding contact bounce time.) (without diode)			
Mechanical characteristics	Shock resistance	Functional	Min. 98 m/s <sup>2</sup> (Half-wave pulse of sine wave: 11 ms; detection time: 10μs.)	
		Destructive	Min. 980 m/s <sup>2</sup> (Half-wave pulse of sine wave: 6 ms.)	
	Vibration resistance	Functional	10 to 55 Hz at double amplitude of 1.5 mm (Detection time: 10μs.)	
		Destructive	10 to 55 Hz at double amplitude of 3 mm	
Expected life	Mechanical	Min. 5×10 <sup>7</sup> (at 300 times/min.)		
Conditions	Conditions for operation, transport and storage*3	Ambient temperature: -40°C to +65°C -40°F to +149°F, Humidity: 5 to 85% R.H. (Not freezing and condensing at low temperature)		
Unit weight		Approx. 5 g .18 oz	Approx. 6 g .21 oz	Approx. 6 g .21 oz

Notes: \*1. This value can change due to the switching frequency, environmental conditions, and desired reliability level, therefore it is recommended to check this with the actual load.

\*2. Wave is standard shock voltage of ±1.2×50μs according to JEC-212-1981

\*3. The upper limit of the ambient temperature is the maximum temperature that can satisfy the coil temperature rise value. Refer to Usage, transport and storage conditions in NOTES.

**3. Electrical life**

Condition: Resistive load, at 20 times/min.

Type	Switching capacity	Number of operations
1 Form A	10A 250V AC 10A 30V DC	Min. 1×10 <sup>5</sup>
1 Form A 1 Form B, 2 Form A	8A 250V AC 8A 30V DC	Min. 1×10 <sup>5</sup>

**REFERENCE DATA**

1-(1). Maximum operating power (1 Form A)

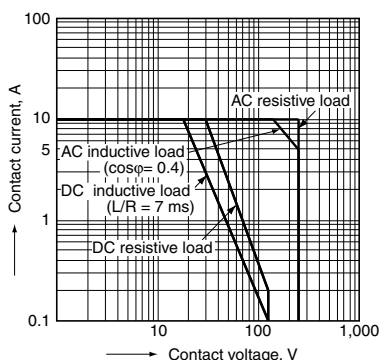

1-(2). Maximum operating power (1 Form A 1 Form B, 2 Form A)

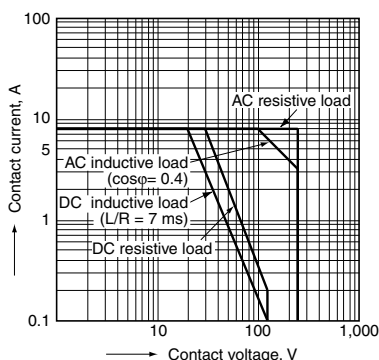

2-(1). Life curve (1 Form A)

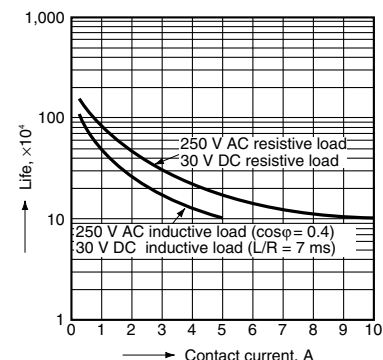

2-(2). Life curve  
(1 Form A 1 Form B, 2 Form A)

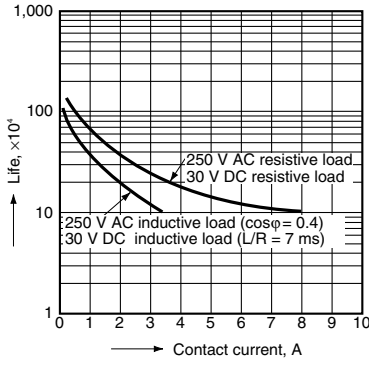

3-(1). Operate/Release time (1 Form A)  
Tested sample: DK1a-24V, 5 pcs.

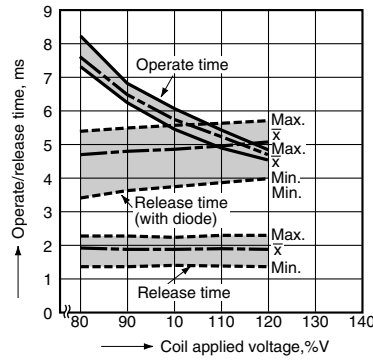

3-(2). Operate/Release time  
(1 Form A 1 Form B, 2 Form A)  
Tested sample: DK1a1b-12V, 5 pcs.

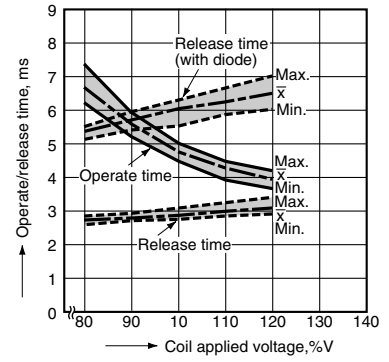

4-(1). Coil temperature rise (1 Form A)  
Tested sample: DK1a-12V, 5 pcs.  
Ambient temperature: 30°C 86°F

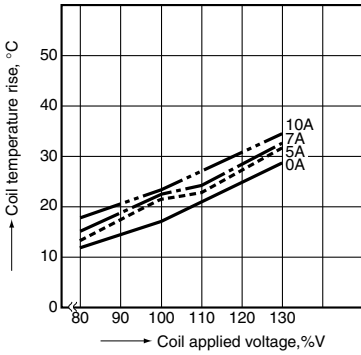

4-(2). Coil temperature rise  
(1 Form A 1 Form B, 2 Form A)  
Tested sample: DK1a1b-12V, 5 pcs.  
Ambient temperature: 20°C 68°F

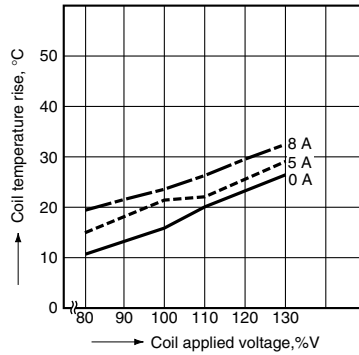

5-(1). Ambient temperature characteristics  
(1 Form A)  
Tested sample: DK1a-24V, 6 pcs  
Ambient temperature: -40°C to +80°C  
-40°F to +176°F

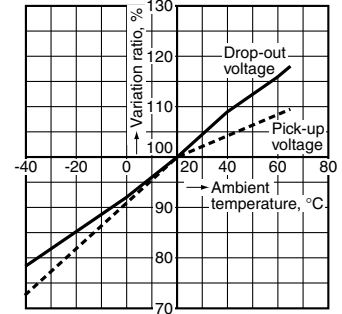

5-(2). Ambient temperature characteristics  
(1 Form A 1 Form B, 2 Form A)

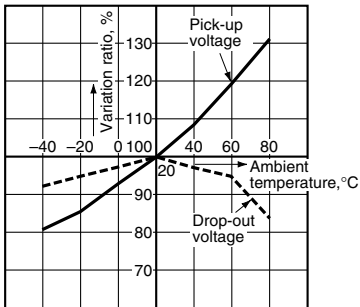

# DIMENSIONS (mm inch)

The CAD data of the products with a **CAD Data** mark can be downloaded from: <http://industrial.panasonic.com/ac/e/>

## 1. 1 Form A type

**CAD Data**

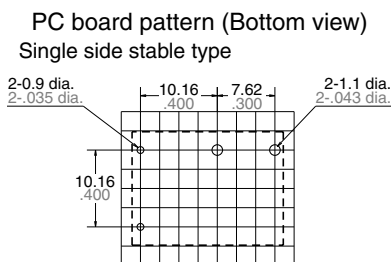
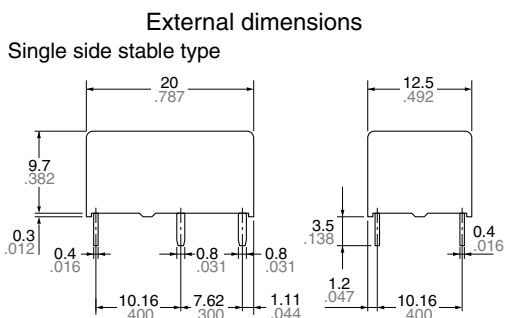
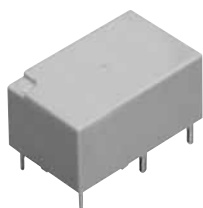

**Schematic (Bottom view)**  
Single side stable type

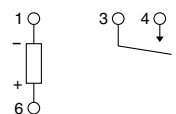

(Deenergized condition)

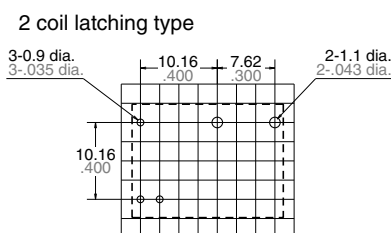
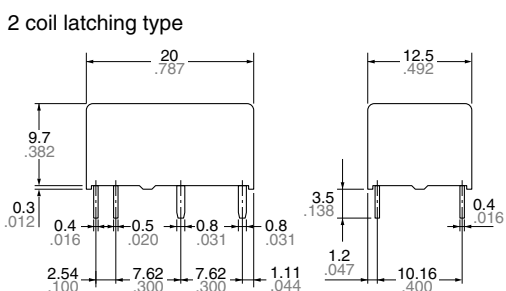

**2 coil latching type**

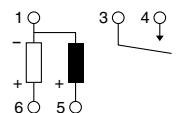

(Reset condition)

General tolerance:  $\pm 0.3 \pm 0.012$

Tolerance:  $\pm 0.1 \pm 0.004$

Since this is a polarized relay, the connection to the coil should be done according to the above schematic.

## 2. 1 Form A 1 Form B type, 2 Form A type

**CAD Data**

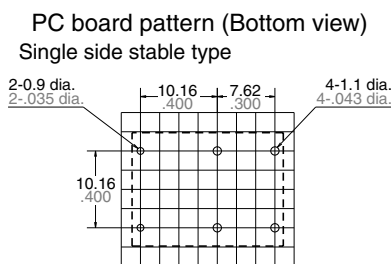
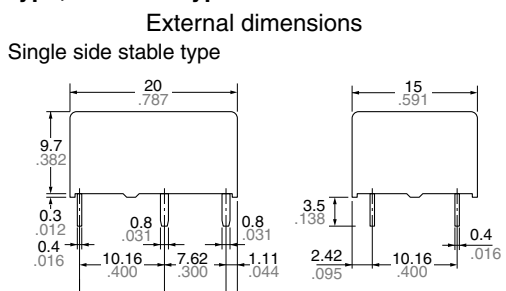
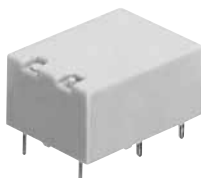
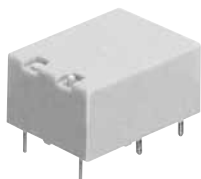

**Schematic (Bottom view)**  
<1 Form A 1 Form B type>  
Single side stable type

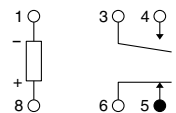

(Deenergized condition)

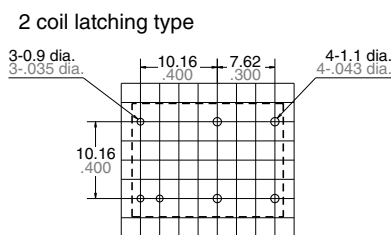
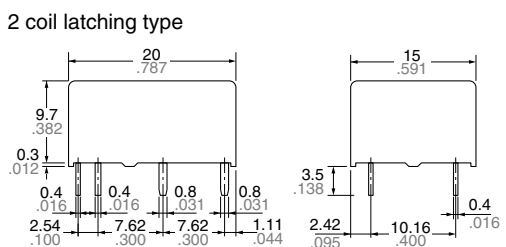

**2 coil latching type**

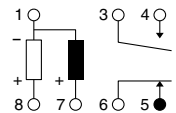

(Reset condition)

General tolerance:  $\pm 0.3 \pm 0.012$

Tolerance:  $\pm 0.1 \pm 0.004$

<2 Form A>  
Single side stable type

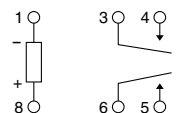

(Deenergized condition)

**2 coil latching type**

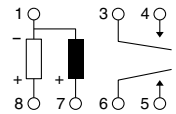

(Reset condition)

Since this is a polarized relay, the connection to the coil should be done according to the above schematic.

## SAFETY STANDARDS

Type	UL/C-UL (Recognized)		CSA (Certified)		TÜV (Certified)	
	File No.	Rating	File No.	Rating	File No.	Rating
1 Form A	E43028	10A 250V AC	LR26550	10A 250V AC	B 12 06 13461 329	10A 250V AC (cos $\phi$ =1.0)
		10A 30V DC		10A 30V DC		10A 30V DC (0ms)
		1/3HP 125, 250V AC		1/3HP 125, 250V AC		5A 250V AC (cos $\phi$ =0.4)
1 Form A 1 Form B, 2 Form A	E43028	8A 250V AC	LR26550	8A 250V AC	B 12 06 13461 329	8A 250V AC (cos $\phi$ =1.0)
		8A 30V DC		8A 30V DC		8A 30V DC (0ms)
		1/4HP 125, 250V AC		1/4HP 125, 250V AC		4A 250V AC (cos $\phi$ =0.4)

Notes: VDE approved type is available. Please contact our company.

## INSULATION CHARACTERISTICS (IEC61810-1)

Item	Characteristics
Clearance/Creepage distance (IEC61810-1)	Min. 5.5/5.5mm
Category of protection (IEC61810-1)	RT III
Tracking resistance (IEC60112)	PTI 175
Insulation material group	III a
Over voltage category	III
Rated voltage	250V
Pollution degree	2
Type of insulation (Between contact and coil)	Reinforced insulation
Type of insulation (Between open contacts)	Micro disconnection

Notes: 1. EN/IEC VDE Certified.  
2. VDE approved type only.

## NOTES

**1. For cautions for use, please read “GENERAL APPLICATION GUIDELINES”.**

**2. Soldering should be done under the following conditions:**

1) Preheating: Within 120°C 248°F and within 120 seconds

2) Soldering iron: 260°C±5°C

500°F±41°F and within 6 seconds

**3. External magnetic field**

Since DK relays are highly sensitive polarized relays, their characteristics will be affected by a strong external magnetic field. Avoid using the relay under that condition.

**4. When using, please be aware that the a contact and b contact sides of 1 Form A 1 Form B type may go on simultaneously at operate time and release time.**



### ACCESSORIES DK RELAY PC BOARD SOCKETS

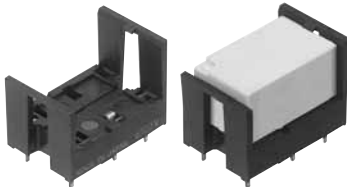

RoHS compliant

### TYPES

Type		Part No.
1 Form A	Single side stable	DK1a-PS
	2 coil latching	DK1a-PSL2
1 Form A 1 Form B, 2 Form A	Single side stable	DK2a-PS
	2 coil latching	DK2a-PSL2

Standard packing: Carton: 50 pcs.; Case: 500 pcs

### RELAY COMPATIBILITY

Relay	Socket	1 Form A		1 Form A 1 Form B, 2 Form A	
		Single side stable type	2 coil latching type	Single side stable type	2 coil latching type
1 Form A	Single side stable type	●	●	—	—
	2 coil latching type	—	●	—	—
1 Form A 1 Form B, 2 Form A	Single side stable type	—	—	●	●
	2 coil latching type	—	—	—	●

### SPECIFICATIONS

Item	Specifications
Breakdown voltage (Initial)	4,000 Vrms (Detection current: 10 mA) (Except the portion between coil terminals)
Insulation resistance (Initial)	Min. 1,000 mΩ (at 500 V DC)
Heat resistance	150°C (for 1 hour)
Max. continuous current	10 A (DK1a-PS, DK1a-PSL2), 8 A (DK2a-PS, DK2a-PSL2)

### DIMENSIONS (mm inch)

The CAD data of the products with a **CAD Data** mark can be downloaded from: <http://industrial.panasonic.com/ac/e/>

#### CAD Data External dimensions

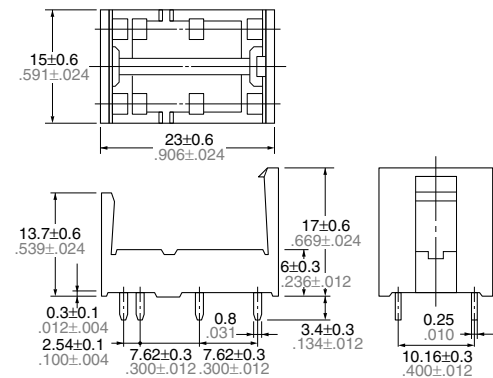

General tolerance: ±0.3 ±.012

#### PC board pattern (Bottom view)

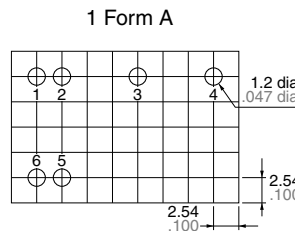

Note: The above shows 2 coil latching type. No.2 and 5 terminal are eliminated on single side stable type.

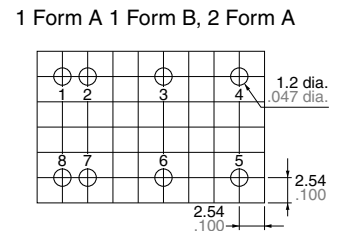

Tolerance: ±0.1 ±.004

Note: The above shows 2 coil latching type. No.2 and 7 terminal are eliminated on single side stable type.

### FIXING AND REMOVAL METHOD

1. Match the direction of relay and socket.

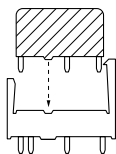

2. Both ends of the relay are to be secured firmly so that the socket hooks on the top surface of the relay.

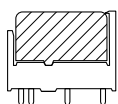

GOOD

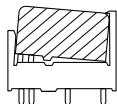

NO GOOD

3. Remove the relay, applying force in the direction shown below.

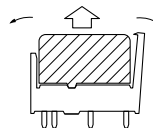

4. In case there is not enough space to grasp relay with fingers, use screwdrivers in the way shown below.

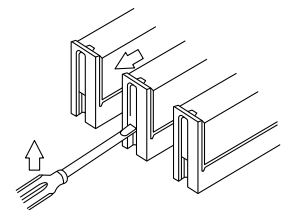

Notes: 1. Exercise care when removing relays. If greater than necessary force is applied at the socket hooks, deformation may alter the dimensions so that the hook will no longer catch, and other damage may also occur.  
2. It is hazardous to use IC chip sockets.

---

Please contact .....

**Panasonic Corporation**

Electromechanical Control Business Division

■ 1006, Oaza Kadoma, Kadoma-shi, Osaka 571-8506, Japan  
[industrial.panasonic.com/ac/e/](http://industrial.panasonic.com/ac/e/)

**Panasonic**<sup>®</sup>

©Panasonic Corporation 2017



# Mouser Electronics

Authorized Distributor

Click to View Pricing, Inventory, Delivery & Lifecycle Information:

## Panasonic:

[DK1A-12V-F](#) [DK1A-24V-F](#) [DK1A1B-L-3V](#) [DK1A1B-L2-5V](#) [DK1A1B-5V](#) [DK2A-5V](#) [DK1A1B-6V](#) [DK1A1B-12V](#)  
[DK1A1B-24V](#) [DK2A-24V](#) [DK1A-L2-12V](#) [DK1A-L2-24V](#) [DK2A-PS](#) [DK2A-12V](#) [DK2A-L2-12V](#) [DK1A1B-L2-12V](#) [DK1A-](#)  
[L2-12V-F](#) [DK1A-PS](#) [DK2A-L2-5V](#) [DK1A-5V-F](#) [DK1A-L2-24V-F](#) [DK1a1b-3V](#) [DK1a1b-9V](#) [DK1a1b-L2-24V](#) [DK1a1b-](#)  
[L2-3V](#) [DK1a1b-L2-6V](#) [DK1a1b-L2-9V](#) [DK1a-3V-F](#) [DK1a-6V-F](#) [DK1a-9V-F](#) [DK1a-L2-3V-F](#) [DK1a-L2-5V-F](#) [DK1a-L2-](#)  
[9V-F](#) [DK2a-6V](#) [DK2a-L2-24V](#) [DK2a-L2-3V](#) [DK2a-L2-6V](#) [DK1A1B-L-5V](#) [DK1A-3V](#) [DK1A-6V](#) [DK1A-9V](#) [DK1A-B-24V](#)  
[DK1A-B-24V-F](#) [DK1A-L-12V](#) [DK1A-L-12V-F](#) [DK1A-L-24V](#) [DK1A-L2-6V](#) [DK1A-L2-9V](#) [DK1A-L-3V](#) [DK1A-L-5V](#)  
[DK1A-L-6V](#) [DK1A-L-9V](#) [DK1A-PSL2](#) [DK2A-PSL2](#) [DK2a-3V](#) [DK2a-9V](#)

Компания «Океан Электроники» предлагает заключение долгосрочных отношений при поставках импортных электронных компонентов на взаимовыгодных условиях!

Наши преимущества:

- Поставка оригинальных импортных электронных компонентов напрямую с производств Америки, Европы и Азии, а так же с крупнейших складов мира;
- Широкая линейка поставок активных и пассивных импортных электронных компонентов (более 30 млн. наименований);
- Поставка сложных, дефицитных, либо снятых с производства позиций;
- Оперативные сроки поставки под заказ (от 5 рабочих дней);
- Экспресс доставка в любую точку России;
- Помощь Конструкторского Отдела и консультации квалифицированных инженеров;
- Техническая поддержка проекта, помощь в подборе аналогов, поставка прототипов;
- Поставка электронных компонентов под контролем ВП;
- Система менеджмента качества сертифицирована по Международному стандарту ISO 9001;
- При необходимости вся продукция военного и аэрокосмического назначения проходит испытания и сертификацию в лаборатории (по согласованию с заказчиком);
- Поставка специализированных компонентов военного и аэрокосмического уровня качества (Xilinx, Altera, Analog Devices, Intersil, Interpoint, Microsemi, Actel, Aeroflex, Peregrine, VPT, Syfer, Eurofarad, Texas Instruments, MS Kennedy, Miteq, Cobham, E2V, MA-COM, Hittite, Mini-Circuits, General Dynamics и др.);

Компания «Океан Электроники» является официальным дистрибьютором и эксклюзивным представителем в России одного из крупнейших производителей разъемов военного и аэрокосмического назначения «JONHON», а так же официальным дистрибьютором и эксклюзивным представителем в России производителя высокотехнологичных и надежных решений для передачи СВЧ сигналов «FORSTAR».



## JONHON

«JONHON» (основан в 1970 г.)

Разъемы специального, военного и аэрокосмического назначения:

(Применяются в военной, авиационной, аэрокосмической, морской, железнодорожной, горно- и нефтедобывающей отраслях промышленности)

«FORSTAR» (основан в 1998 г.)

ВЧ соединители, коаксиальные кабели, кабельные сборки и микроволновые компоненты:

(Применяются в телекоммуникациях гражданского и специального назначения, в средствах связи, РЛС, а так же военной, авиационной и аэрокосмической отраслях промышленности).



Телефон: 8 (812) 309-75-97 (многоканальный)

Факс: 8 (812) 320-03-32

Электронная почта: [ocean@oceanchips.ru](mailto:ocean@oceanchips.ru)

Web: <http://oceanchips.ru/>

Адрес: 198099, г. Санкт-Петербург, ул. Калинина, д. 2, корп. 4, лит. А