

Micro Relay K (THT – THR)

- Small power relay
- Limiting continuous current 20A at 85°C
- Low weight
- Low noise operation
- Wave (THT) and reflow (THR/pin-in-paste) solderable versions

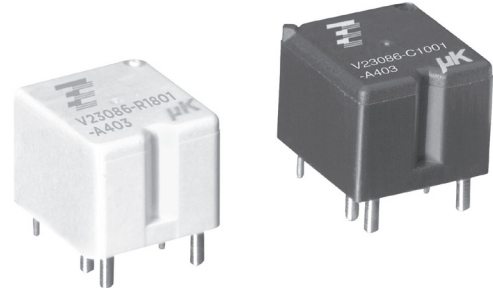

086C/R1_fw1b

Typical applications
Door lock, heated front/rear screen, lamps front/rear/fog light, interior lights, seat control, sun roof, window lifter, wiper control.

Contact Data				
Typical applications	Inductive load V23086-*1*01-A403	Wiper load V23086-*1*02-A803	Resistive/inductive load V23086-*1*01-A402	Lamp load V23086-*1*51-A502
Contact arrangement	1 form C, 1 CO	1 form C, 1 CO	1 form A, 1 NO	1 form A, 1 NO
Rated voltage	12VDC	10VDC	12VDC	10VDC
Rated current ¹⁾	NO/NC 30/25A	NO/NC 30/25A	30A	15A
Limiting continuous current ¹⁾				
23°C	30/25A	30/25A	30A	15A
85°C	20/15A	20/15A	20A	10A
105°C	15/10A	15/10A	15A	
Limiting making current	40A ²⁾	40A ²⁾	40A ²⁾	100A ³⁾
Limiting breaking current	30A	30A	30A	30A
Contact material		AgSnO ₂		
Min. contact load		>1A at 5VDC ⁴⁾		
Initial voltage drop at 10A, typ./max.		30/300mV		
Operate/release time		typ. 3/1.5ms ⁵⁾		
Electrical endurance				
cyclic temperature -40°C, +25°C, +85°C				
form C contact (CO) at 14VDC	motor reverse blocked, 25A, 0.77mH >1x10 ⁵ ops.	wiper, 25A make/5A break, generator peak, 20A on NC, 1mH >1x10 ⁶ ops.		
form A contact (NO) at 14VDC			resistive 20A >3x10 ⁵ ops.	lamp 100A inrush, 10A steady state >1x10 ⁵ ops.
Mechanical endurance		>5x10 ⁶ ops.		

Max. DC load breaking capacity

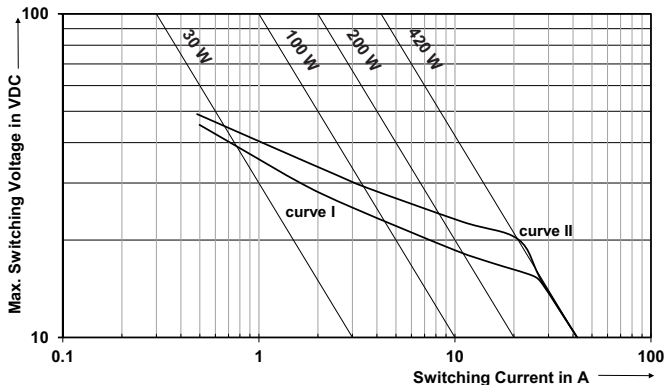

Load limit curve 1: arc extinguishes, during transit time (changeover contact).
Load limit curve 2: safe shutdown, no stationary arc (make contact).
Load limit curves measured with low inductive resistors verified for 1000 switching events.

- 1) Measured on 70x70x1.5mm epoxy PCB FR4 with 25cm² (double layer 105µm) copper area. Connecting cable cross section 6 mm². Boundary conditions: 180°C coil temperature; 130°C solder joint.
- 2) The values apply to a resistive or inductive load with suitable spark suppression and at maximum 13.5VDC for 12VDC load voltages. For a load current duration of maximum 3s for a make/break ratio of 1:10.
- 3) Corresponds to the peak inrush current on initial actuation (cold filament).
- 4) See chapter Diagnostics of Relays in our Application Notes or consult the internet at <http://relays.te.com/appnotes/>
- 5) Measured at nominal voltage without coil suppression unit. A low resistive suppression device in parallel to the relay coil increases the release time and reduces the lifetime caused by increased erosion and/or higher risk of contact tack welding.

Micro Relay K (THT – THR) (Continued)

Coil Data

Rated coil voltage	12VDC
--------------------	-------

Coil versions, DC coil

Coil code	Rated voltage VDC	Operate voltage VDC	Release voltage VDC	Coil resistance $\Omega \pm 10\%$	Rated coil power mW
001/801	12	6.9	1.5	254	567
002/802	10	5.7	1.25	181	552
051/851	10	6.5	1.1	90	1111

All figures are given for coil without pre-energization, at ambient temperature +23°C.

Coil operating range

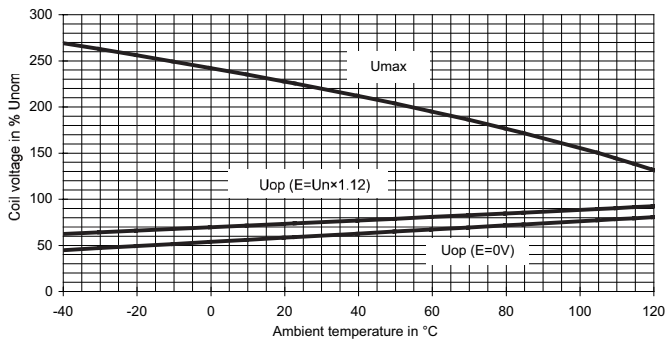

Does not take into account the temperature rise due to the contact current
E = pre-energization

Insulation Data

Initial dielectric strength	
between open contacts	500VAC _{rms}
between contact and coil	500VAC _{rms}

Other Data

EU RoHS/ELV compliance	compliant
Ambient temperature, DC coil	-40 to +105°C
Cold storage, IEC 60068-2-1	1000h; -40°C
Dry heat, IEC 60068-2-2	1000h; +125°C
Climatic cycling with condensation, EN ISO 6988	20 cycles, storage 8/16h
Temperature cycling (shock), IEC 60068-2-14, Na	100 cycles; -40/+125°C
Temperature cycling, IEC 60068-2-14, Nb	35 cycles; -40/+125°C
Damp heat cyclic, IEC 60068-2-30, Db, variant 1	6 cycles 25°C/55°C/93%RH
Damp heat constant, IEC 60068-2-3 method Ca	56 days 40°C/95%RH
Degree of protection	
THT:	RT III (61810), IP67 (IEC 60529)
THR:	RT II (61810), IP56 (IEC 60529)
Sealing test, IEC 60068-2-17: THT	Qc, method 2, 1min, 70°C
Corrosive gas	
IEC 60068-2-42	10 days
IEC 60068-2-43	10 days
Vibration resistance (functional)	
IEC 60068-2-6 (sine sweep)	10 to 500Hz; 6g ⁶⁾
Shock resistance (functional)	
IEC 60068-2-27 (half sine)	6ms, up to 30g ⁶⁾
Terminal type	PCB:THT, THR
Weight	approx. 4g (0.14oz)
Solderability (aging 3: 4h/155°C) THT	
IEC 60068-2-20	Ta, method 1, hot dip 5s, 215°C
Solderability THR	
IEC60068-2-58	hot dip 5s 245°C
Resistance to soldering heat THT	
IEC 60068-2-20	Tb, method 1A, hot dip 10s, 260°C with thermal screen
Resistance to soldering heat THR	
IEC 60068-2-58	260°C; preheating min 130°C
Storage conditions	according IEC 60068-1 ⁷⁾
Packaging unit	2000 pcs.

6) Depending on mounting position: no change in the switching state >10µs.

7) For general storage and processing recommendations please refer to our Application Notes and especially to Storage in the Definitions or at <http://relays.te.com/appnotes/>

Micro Relay K (THT – THR) (Continued)

Terminal Assignment

Bottom view on solder pins

1 form A, 1 NO

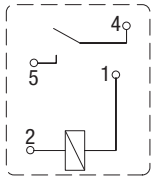

86ets_ab

1 form C, 1 CO

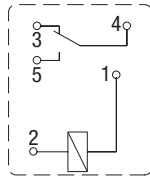

86etw_ab

Dimensions

Micro Relay K, THT version

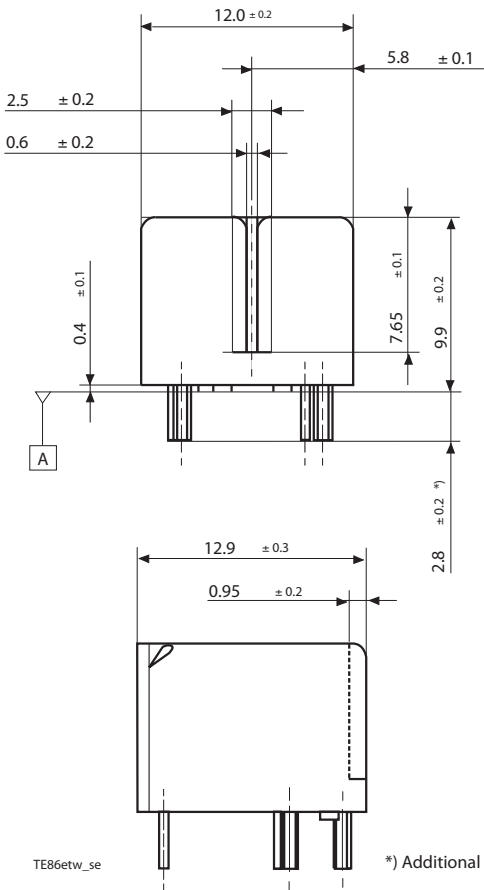

TE86etw_se

*) Additional tin tops max. 1 mm

*) Additional tin tops max. 1 mm

Mounting Hole Layout

Bottom view on solder pins

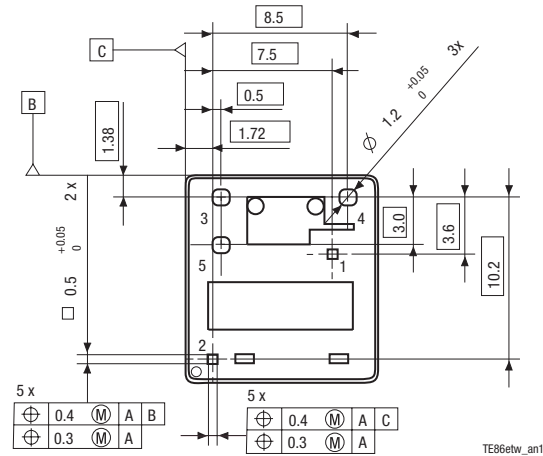

TE86etw_an1

Remark: Positional tolerances according to DIN EN ISO 5458

Micro Relay K (THT – THR) (Continued)

Micro Relay K, THR version

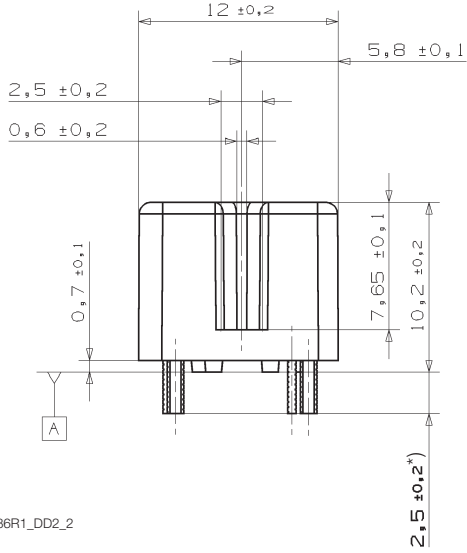

Mounting Hole Layout
Bottom view on solder pins

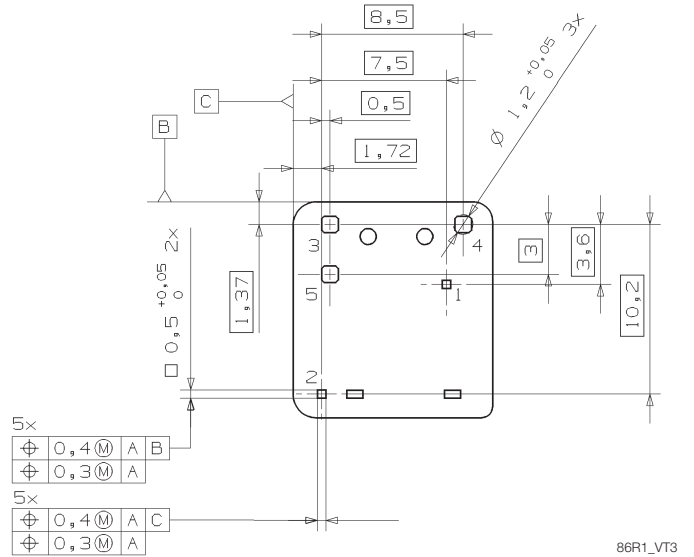

View of Stand-Offs
Bottom view on solder pins

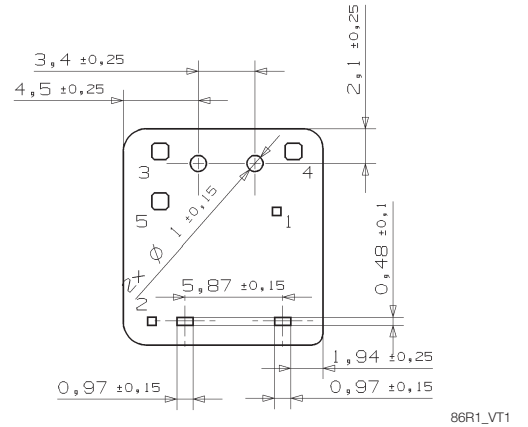

*) Additional tin tops max. 1mm

Micro Relay K (THT – THR) (Continued)

Product code structure		Typical product code		V23086	-C	1	001	-A	4	03
Type										
V23086 Micro Relay K (THT – THR)										
Terminal and enclosure										
C		PCB version THT, sealed			R		PCB version THR, vented			
Design										
1		Single relay								
Coil										
001		Standard (THT)			002		Sensitive (THT)			
801		Standard (THR)			802		Sensitive (THR)			
051		Lamp load (THT)			851		Lamp load (THR)			
Contact type										
A		Single contact								
Contact material index										
4		AgSnO ₂ standard			8		AgSnO ₂ wiper load			
5		AgSnO ₂ lamp load								
Contact arrangement index										
02		NO			03		CO			

Product code	Version	Design	Coil	Contact	Cont. material	Arrangement	Part number
V23086-C1001-A402	PCB THT, cleanable	Single	Standard	Single	AgSnO ₂ (standard)	1 form A, 1 NO	0-1393280-5
V23086-C1001-A403						1 form C, 1 CO	0-1393280-6
V23086-C1051-A502			Lamp load		AgSnO ₂ (lamp)	1 form A, 1 NO	2-1904093-1
V23086-C1002-A803			Sensitive		AgSnO ₂ (wiper)	1 form C, 1 CO	2-1414987-3
V23086-R1801-A402	PCB THR, vented		Standard		AgSnO ₂ (standard)	1 form A, 1 NO	2-1904093-2
V23086-R1801-A403						1 form C, 1 CO	6-1414920-0
V23086-R1851-A502			Lamp load		AgSnO ₂ (lamp)	1 form A, 1 NO	9-1904064-4
V23086-R1802-A803			Sensitive		AgSnO ₂ (wiper)	1 form C, 1 CO	7-1414967-8

This list represents the most common types and does not show all variants covered by this datasheet. Other types on request.

Компания «Океан Электроники» предлагает заключение долгосрочных отношений при поставках импортных электронных компонентов на взаимовыгодных условиях!

Наши преимущества:

- Поставка оригинальных импортных электронных компонентов напрямую с производств Америки, Европы и Азии, а так же с крупнейших складов мира;
- Широкая линейка поставок активных и пассивных импортных электронных компонентов (более 30 млн. наименований);
- Поставка сложных, дефицитных, либо снятых с производства позиций;
- Оперативные сроки поставки под заказ (от 5 рабочих дней);
- Экспресс доставка в любую точку России;
- Помощь Конструкторского Отдела и консультации квалифицированных инженеров;
- Техническая поддержка проекта, помощь в подборе аналогов, поставка прототипов;
- Поставка электронных компонентов под контролем ВП;
- Система менеджмента качества сертифицирована по Международному стандарту ISO 9001;
- При необходимости вся продукция военного и аэрокосмического назначения проходит испытания и сертификацию в лаборатории (по согласованию с заказчиком);
- Поставка специализированных компонентов военного и аэрокосмического уровня качества (Xilinx, Altera, Analog Devices, Intersil, Interpoint, Microsemi, Actel, Aeroflex, Peregrine, VPT, Syfer, Eurofarad, Texas Instruments, MS Kennedy, Miteq, Cobham, E2V, MA-COM, Hittite, Mini-Circuits, General Dynamics и др.);

Компания «Океан Электроники» является официальным дистрибьютором и эксклюзивным представителем в России одного из крупнейших производителей разъемов военного и аэрокосмического назначения «JONHON», а так же официальным дистрибьютором и эксклюзивным представителем в России производителя высокотехнологичных и надежных решений для передачи СВЧ сигналов «FORSTAR».



JONHON

«JONHON» (основан в 1970 г.)

Разъемы специального, военного и аэрокосмического назначения:

(Применяются в военной, авиационной, аэрокосмической, морской, железнодорожной, горно- и нефтедобывающей отраслях промышленности)

«FORSTAR» (основан в 1998 г.)

ВЧ соединители, коаксиальные кабели, кабельные сборки и микроволновые компоненты:

(Применяются в телекоммуникациях гражданского и специального назначения, в средствах связи, РЛС, а так же военной, авиационной и аэрокосмической отраслях промышленности).



Телефон: 8 (812) 309-75-97 (многоканальный)

Факс: 8 (812) 320-03-32

Электронная почта: ocean@oceanchips.ru

Web: <http://oceanchips.ru/>

Адрес: 198099, г. Санкт-Петербург, ул. Калинина, д. 2, корп. 4, лит. А