

## CMOS LDO Regulator Series for Portable Equipments

# High-speed Load Response FULL CMOS LDO Regulators

**BU□□TA2WNVX Series, BU□□TA2WHFV Series**

No.09020EAT01

**●Description**

BU□□TA2WNVX /HFV series is high-performance FULL CMOS regulator with 200-mA output, which is mounted on microminiature package SSON004X1216 (1.2 mm × 1.6 mm × 0.6 mm) & HVSO5 (1.6mm X 1.6mm X 0.6mm). It has excellent noise characteristics and load responsiveness characteristics despite its low circuit current consumption of 40 μA. It is most appropriate for various applications such as power supplies for logic IC, RF, and camera modules. Microminiature package SSON004X1216 & HVSO5 with built-in heatsink is adopted for the package, which contributes to the space-saving design of the set.

**●Features**

- 1) High-accuracy output voltage of ±1% (±25 mV on 1.5-V & 1.8-V products)
- 2) High ripple rejection: 70 dB (Typ., 1 kHz, VOUT ≤ 1.8 V)
- 3) Compatible with small ceramic capacitor (CIN=Co=1.0 μF)
- 4) Low current consumption: 40 μA
- 5) ON/OFF control of output voltage
- 6) With built-in overcurrent protection circuit and overheat protection circuit
- 7) With built-in output discharge circuit
- 8) Adopting microminiature power package SSON004X1216

**●Applications**

Battery-powered portable equipment, etc.

**● Absolute maximum rating**

Parameter	Symbol	Limits	Unit
Maximum applied power voltage	VMAX	-0.3 ~ +6.5	V
Power dissipation	Pd1	220* <sup>1</sup> (SSON004X1216)	mW
	Pd2	410* <sup>2</sup> (HVSO5)	mW
Maximum junction temperature	TjMAX	+125	°C
Operational temperature range	Topr	-40 ~ +85	°C
Storage temperature range	Tstg	-55 ~ +125	°C

\*1 When 1 PCB (70 mm × 70 mm, thickness 1.6-mm glass epoxy) a standard ROHM board is implemented.  
Reduced to 2.2 mW/°C when used at Ta=25°C or higher.

\*2 When 1 PCB (70 mm × 70 mm, thickness 1.6-mm glass epoxy) a standard ROHM board is implemented.  
Reduced to 4.1 mW/°C when used at Ta=25°C or higher.

**● Recommended operating range (Do not exceed Pd.)**

Parameter	Symbol	Limits	Unit
Input power supply voltage	VIN	2.5 ~ 5.5	V
Maximum output current	IMAX	200	mA

**● Recommended operating conditions**

Parameter	Symbol	Min.	Typ.	Max.	Unit	Conditions
Input capacitor	CIN	0.5* <sup>3</sup>	1.0	—	μF	A ceramic capacitor is recommended.
Output capacitor	Co	0.5* <sup>3</sup>	1.0	—	μF	A ceramic capacitor is recommended.

\*3 Set the capacity value of the capacitor so that it does not fall below the minimum value, taking temperature characteristics, DC device characteristics, and change with time into consideration.

- Block diagram, recommended circuit diagram, and pin configuration diagram

**BH□□TA2WNVX**

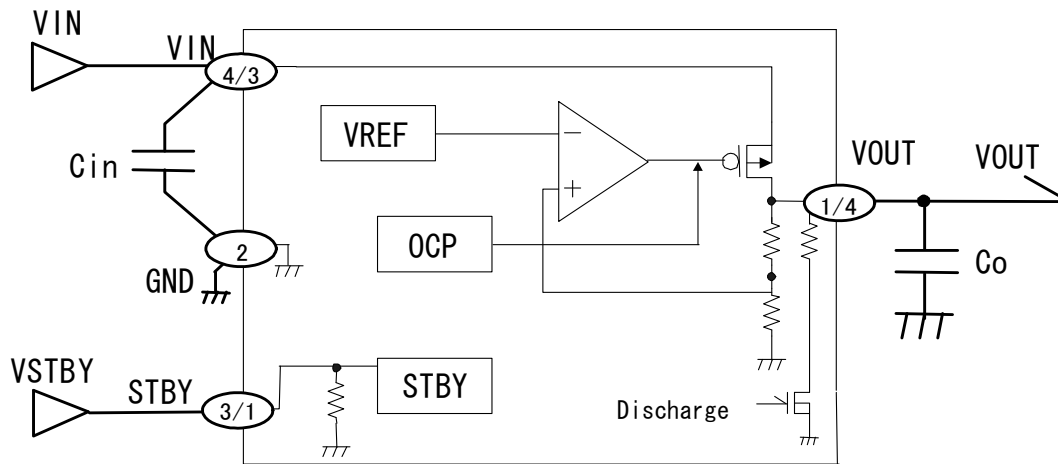
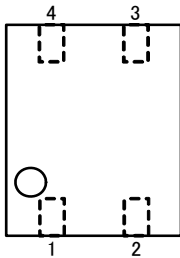

Fig.1 Recommended circuit diagram

Recommended ceramic capacitor for Cin & Co  
Murata Manufacturing Co., Ltd.  
GRM188B11A105KA61D

**BU□□TA2WNVX(SSON004X1216)**



PIN No.	Symbol	Function
1	VOUT	Voltage output
2	GND	Grounding
3	STBY	ON/OFF control of output voltage (High: ON, Low: OFF)
4	VIN	Power input

**BU□□TA2WHFV(HVSOF5)**

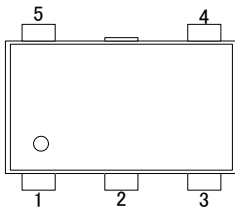

PIN No.	Symbol	Function
1	STBY	ON/OFF control of output voltage (High:ON, Low:OFF)
2	GND	Grounding
3	VIN	Power input
4	VOUT	Voltage output
5	N.C.	No Connect

● **Electrical characteristics** ( $T_a=25^\circ\text{C}$ ,  $V_{IN}=V_{OUT}+1.0\text{ V}$  ( $V_{IN}=3.5\text{ V}$  on  $V_{OUT}=1.8\text{-V}$  and  $1.5\text{-V}$  products),  $STBY=1.5\text{ V}$ ,  $C_{IN}=1.0\text{ }\mu\text{F}$ ,  $C_O=1.0\text{ }\mu\text{F}$ , unless otherwise specified)

Parameter	Symbol	Min.	Typ.	Max.	Unit	Conditions	
Output voltage	VOUT	$V_{OUT}\times 0.99$	VOUT	$V_{OUT}\times 1.01$	V	$I_{OUT}=10\text{ }\mu\text{A}$ , $V_{OUT}\geq 2.5\text{ V}$	
		$V_{OUT}-25\text{ mV}$		$V_{OUT}+25\text{ mV}$		$I_{OUT}=10\text{ }\mu\text{A}$ , $V_{OUT}< 2.5\text{ V}$	
Circuit current	IIN	-	40	95	$\mu\text{A}$	$I_{OUT}=0\text{ mA}$	
Circuit current (at STBY)	ISTBY	-	-	1	$\mu\text{A}$	$STBY=0\text{ V}$	
Ripple rejection	RR	55	70	-	dB	$V_{RR}=-20\text{ dBv}$ , $f_{RR}=1\text{ kHz}$ , $I_{OUT}=10\text{ mA}$ $1.5\text{ V}\leq V_{OUT}\leq 1.8\text{ V}$	
			65			$V_{RR}=-20\text{ dBv}$ , $f_{RR}=1\text{ kHz}$ , $I_{OUT}=10\text{ mA}$ $2.5\text{ V}\leq V_{OUT}$	
Input/Output voltage difference	VSAT	-	400	800	mV	$2.5\text{ V}\leq V_{OUT}\leq 2.6\text{ V}$ ( $V_{IN}=0.98\times V_{OUT}$ , $I_{OUT}=200\text{ mA}$ )	
		-	360	720	mV	$2.7\text{ V}\leq V_{OUT}\leq 2.85\text{ V}$ ( $V_{IN}=0.98\times V_{OUT}$ , $I_{OUT}=200\text{ mA}$ )	
		-	330	660	mV	$2.9\text{ V}\leq V_{OUT}\leq 3.1\text{ V}$ ( $V_{IN}=0.98\times V_{OUT}$ , $I_{OUT}=200\text{ mA}$ )	
		-	300	600	mV	$3.2\text{ V}\leq V_{OUT}\leq 3.4\text{ V}$ ( $V_{IN}=0.98\times V_{OUT}$ , $I_{OUT}=200\text{ mA}$ )	
Line regulation	VDL	-	2	20	mV	$V_{IN}=V_{OUT}+1.0\text{ V}$ to $5.5\text{ V}$ , $I_{OUT}=10\text{ }\mu\text{A}$	
Load regulation	VDLO	-	10	80	mV	$I_{OUT}=0.01\text{ mA}$ to $100\text{ mA}$	
Overcurrent protection detection current	ILMAX	250	400	700	mA	$V_o=V_{OUT}\times 0.8$	
Output short-circuit current	ISHORT	20	70	150	mA	$V_o=0\text{ V}$	
Output discharge resistance	RDSC	20	40	80	$\Omega$	$V_{IN}=4.0\text{ V}$ , $STBY=0\text{ V}$	
Standby pull-down resistance	RSTB	500	1000	2000	k $\Omega$		
Standby control	ON	VSTBH	1.5	-	5.5	V	
	OFF	VSTBL	-0.3	-	0.3	V	

\* This product does not have radiation-proof design.

● Lineup

■ 200 mA BU□□TA2WNVX / HFV series

Product Name	1.5	1.8	2.5	2.6	2.7	2.8	2.85	Package
BU□□TA2WNVX	○	○	○	○	○	○	○	SSON004X1216 HVSOF5
BU□□TA2WHFV	2.9	3.0	3.1	3.2	3.3	3.4	-	
	○	○	○	○	○	○	-	

Model name: BU□□TA2WNVX / HFV

Symbol	Contents					
a	Specification of output voltage					
	□□	Output voltage (V)	□□	Output voltage (V)	□□	Output voltage (V)
	15	1.5 V(Typ.)	28	2.8 V(Typ.)	32	3.2 V(Typ.)
	18	1.8 V(Typ.)	2J	2.85 V(Typ.)	33	3.3 V(Typ.)
	25	2.5 V(Typ.)	29	2.9 V(Typ.)	34	3.4 V(Typ.)
	26	2.5 V(Typ.)	30	3.0 V(Typ.)	-	-
27	2.7 V(Typ.)	31	3.1 V(Typ.)	-	-	

● Input/Output terminal equivalent circuit schematic

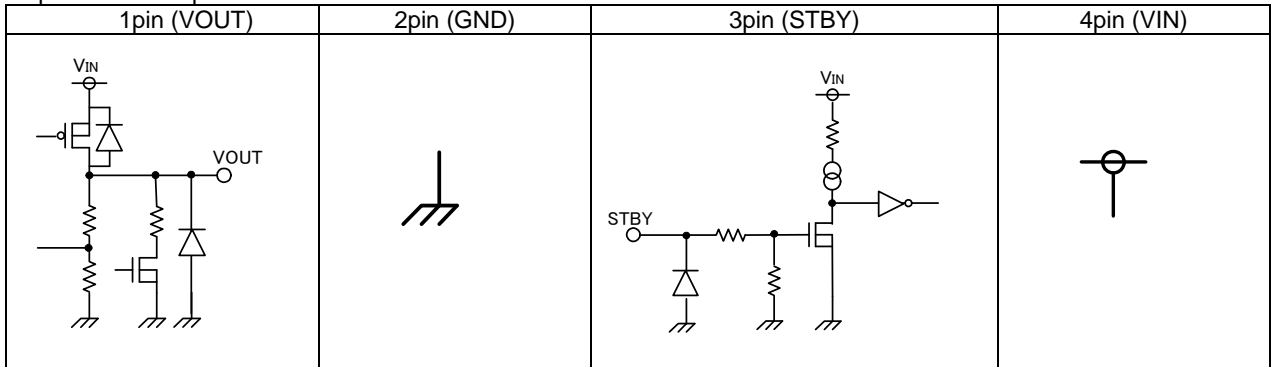

Fig. 2 Input/Output equivalent circuit

● About input/output capacitor

It is recommended to place a capacitor as close as possible to the pins between the input terminal and GND or between the output terminal and GND.

The capacitor between the input terminal and GND becomes valid when source impedance increases or when wiring is long. The larger the capacity of the output capacitor between the output terminal and GND is, the better the stability and characteristics in output load fluctuation become. However, please check the status of actual implementation. Ceramic capacitors generally have variation, temperature characteristics, and direct current bias characteristics and the capacity value also decreases with time depending on the usage conditions. It is recommended to select a ceramic capacitor upon inquiring about detailed data of the related manufacturer.

Capacity value of ceramic capacitor - DC bias characteristics (Example)

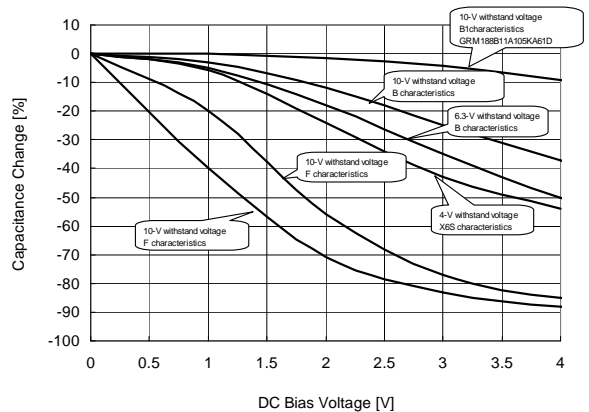

Fig.3 Capacity – bias characteristics

● About the equivalent series resistance (ESR) of a ceramic capacitor

Capacitors generally have ESR (equivalent series resistance) and it operates stably in the ESR-IOUT area shown on the right. Since ceramic capacitors, tantalum capacitors, electrolytic capacitors, etc. generally have different ESR, please check the ESR of the capacitor to be used and use it within the stability area range shown in the right graph for evaluation of the actual application.

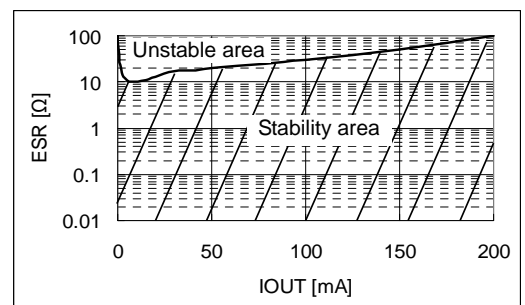

Fig.4 Stability area characteristics (Example)

● Reference data BU15TA2WNVX / HFV (Ta=25°C unless otherwise specified.)

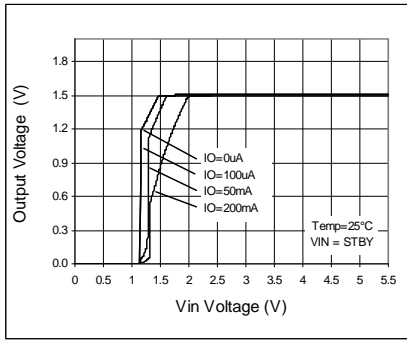

Fig. 5 Output Voltage

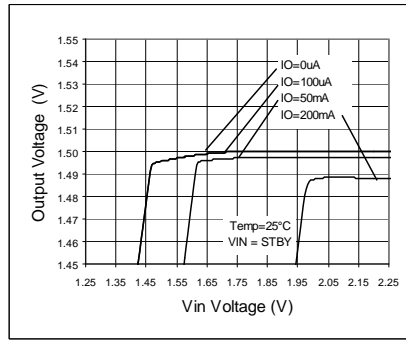

Fig. 6 Line Regulation

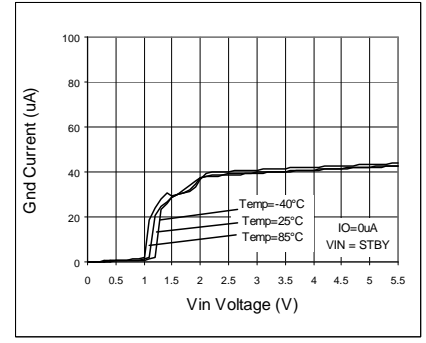

Fig. 7 Circuit Current IGND

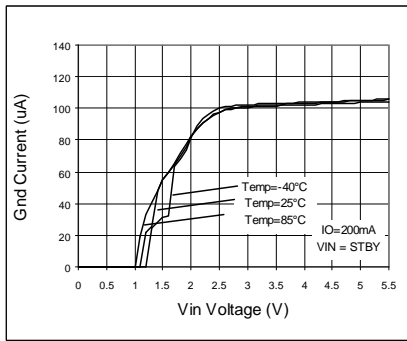

Fig. 8 Circuit Current IGND

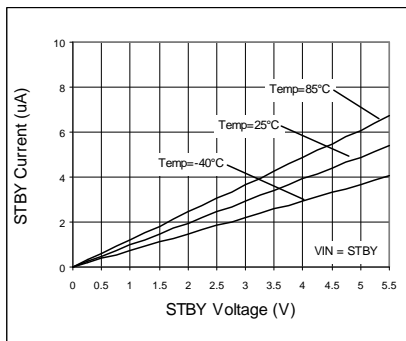

Fig. 9 STBY Input Current

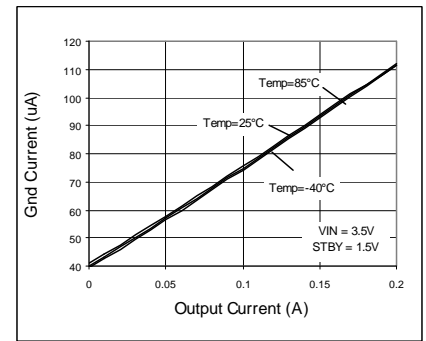

Fig. 10 IOOUT - IGDND

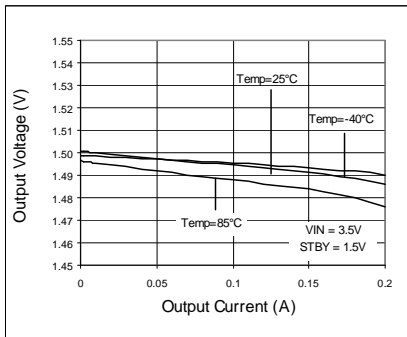

Fig. 11 Load Regulation

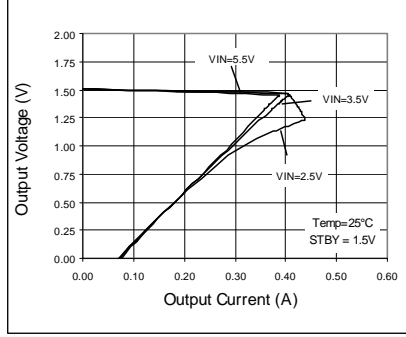

Fig. 12 OCP Threshold

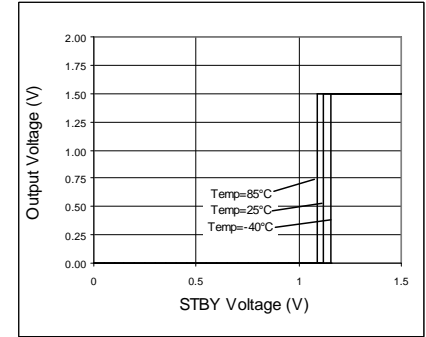

Fig. 13 STBY Threshold

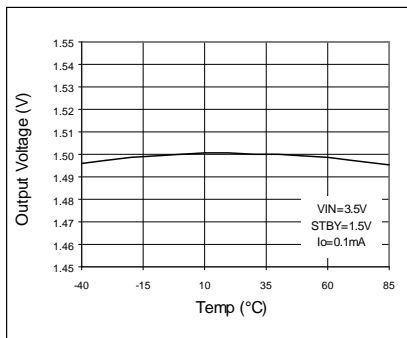

Fig. 14 VOUT vs. Temp

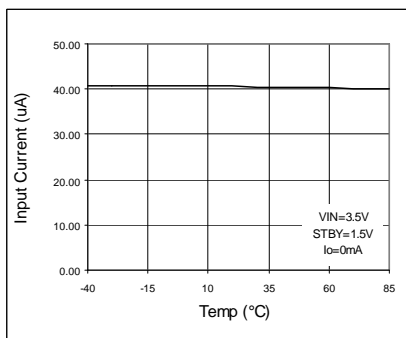

Fig. 15 IGDND vs. Temp

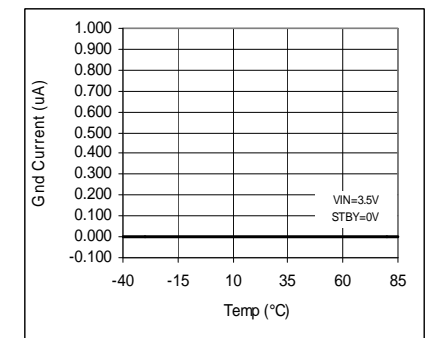

Fig. 16 IGDND vs. Temp (STBY)

● Reference data BU15TA2WNVX /HFV (Ta=25°C unless otherwise specified.)

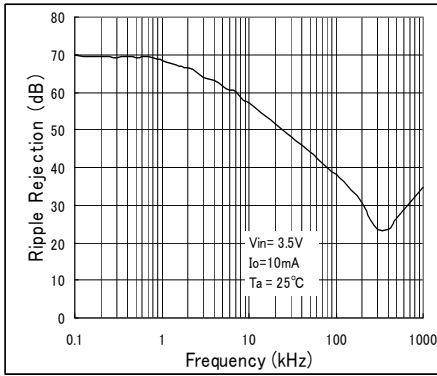

Fig. 17 Ripple Rejection vs. Freq.

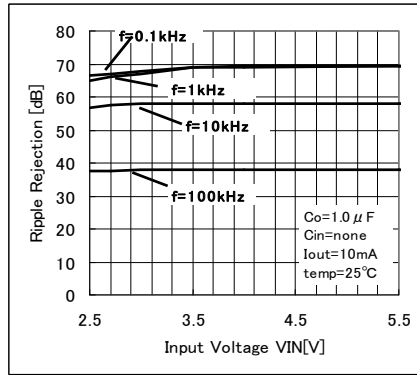

Fig. 18 Ripple Rejection vs. VIN (Iout=10 mA)

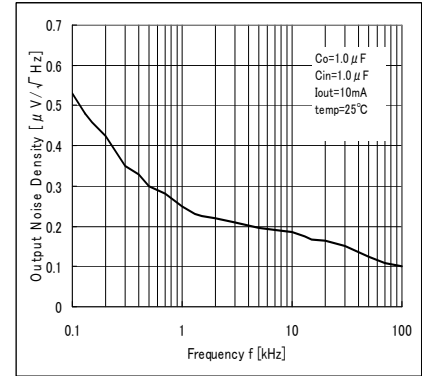

Fig. 19 Output Noise Spectral Density vs. Freq.

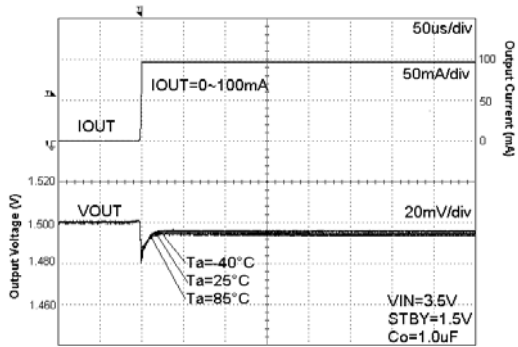

Fig. 20 Load Response

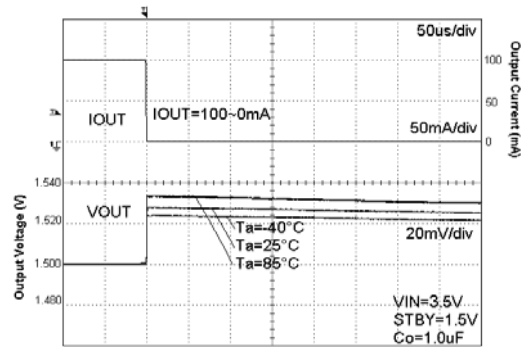

Fig. 21 Load Response

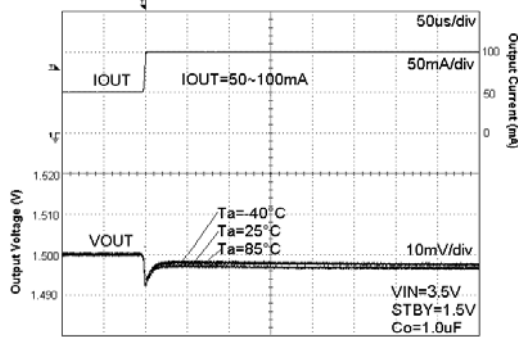

Fig. 22 Load Response

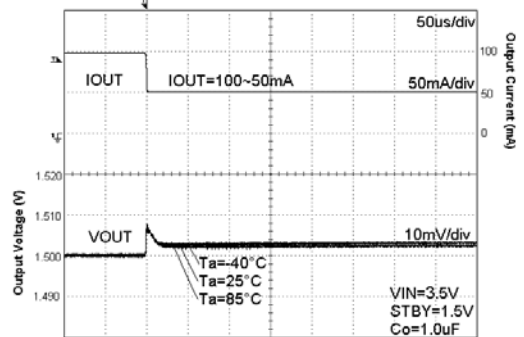

Fig. 23 Load Response

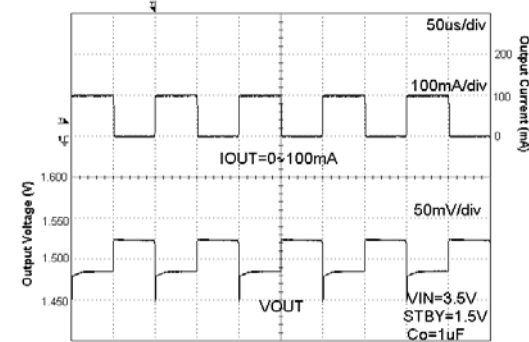

Fig. 24 Load Response Current Pulse=10 kHz

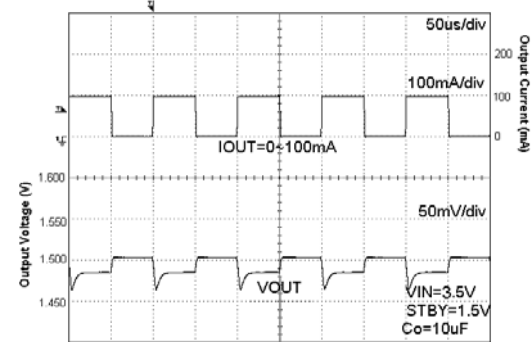

Fig. 25 Load Response Current Pulse=10 kHz

● Reference data BU15TA2WNVX / HFV (Ta=25°C unless otherwise specified.)

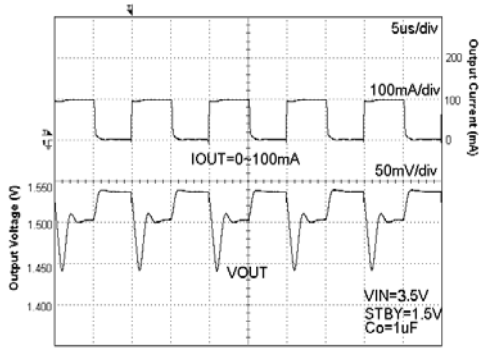

Fig. 26 Load Response  
Current Pulse=100 kHz

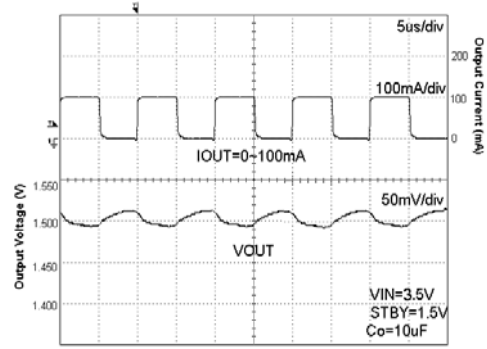

Fig. 27 Load Response  
Current Pulse=100 kHz

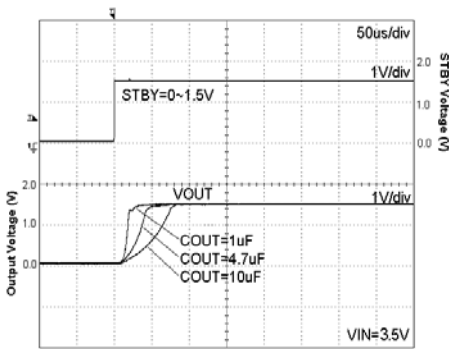

Fig. 28 Startup Time  
Iout = 0 mA

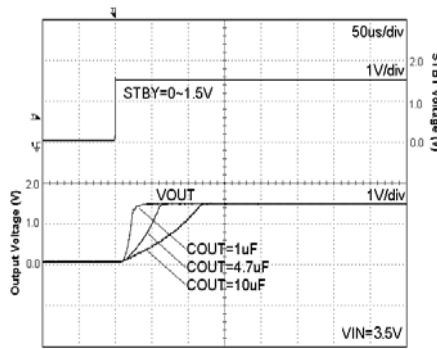

Fig. 29 Startup Time  
Iout = 200 mA

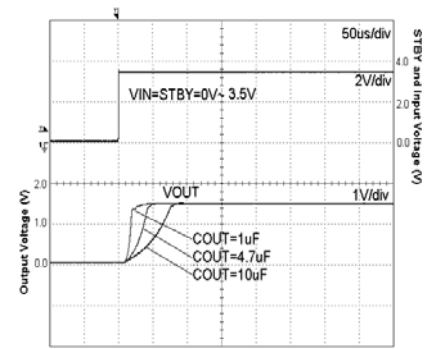

Fig. 30 Startup Time (STBY=VIN)  
Iout = 0 mA

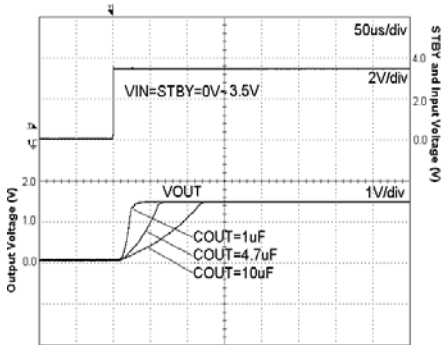

Fig. 31 Startup Time (STBY=VIN)  
Iout = 200mA

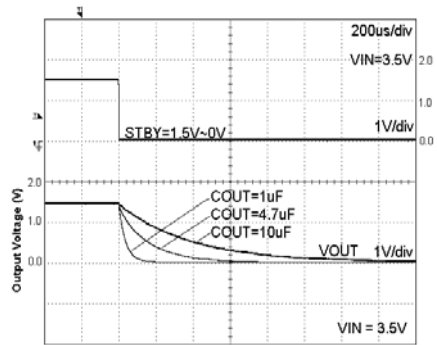

Fig. 32 Discharge Time  
Iout = 0 mA

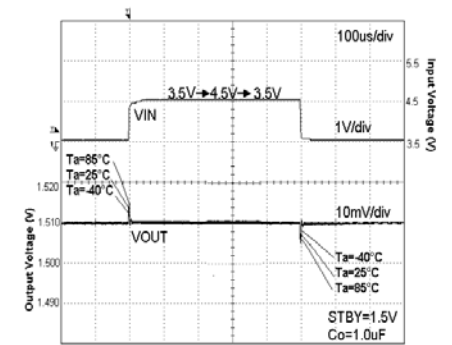

Fig. 33 VIN Response  
Iout = 10 mA

●Reference data BU18TA2WNVX / HFV (Unless otherwise specified, Ta=25°C)

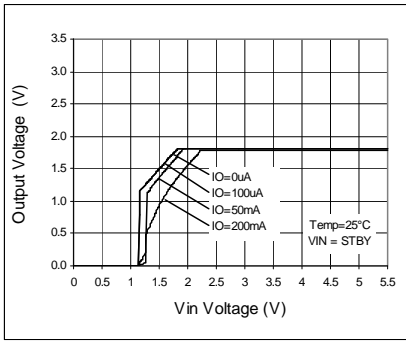

Fig. 34 Output Voltage

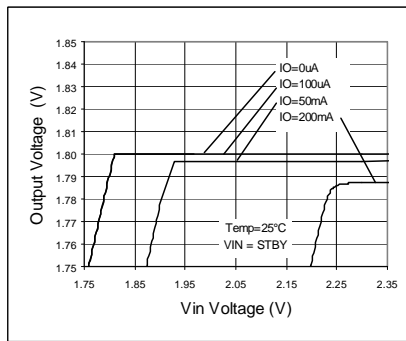

Fig. 35 Line Regulation

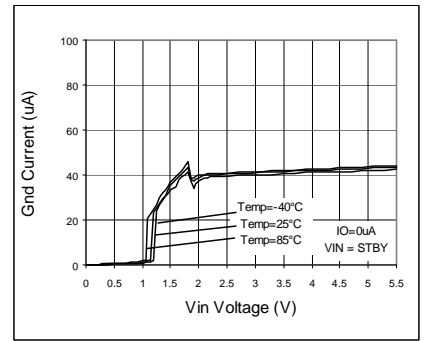

Fig. 36 Circuit Current IGND

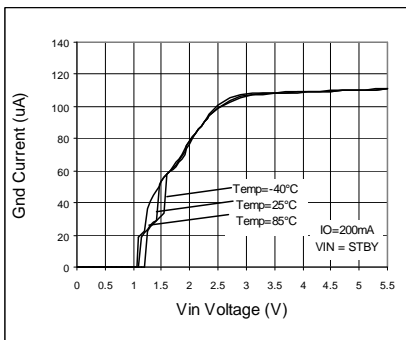

Fig. 37 Circuit Current IGND

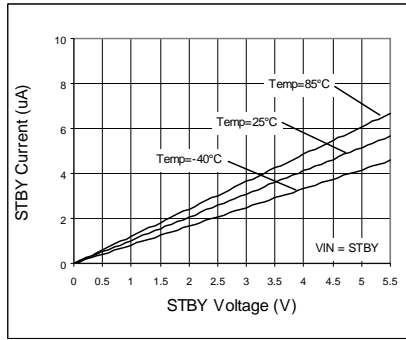

Fig. 38 STBY Input Current

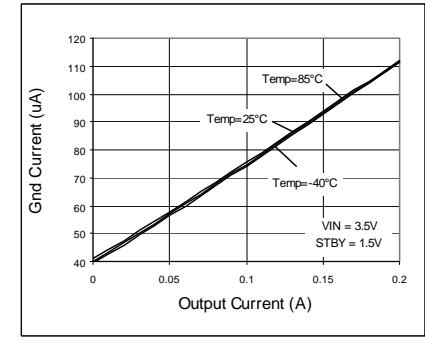

Fig. 39 IOUT - IGND

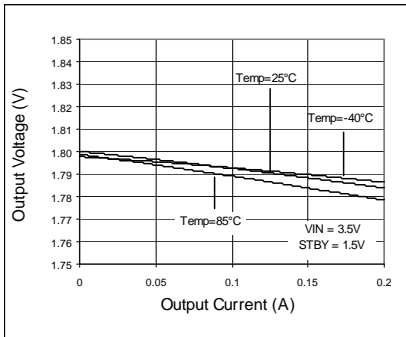

Fig. 40 Load Regulation

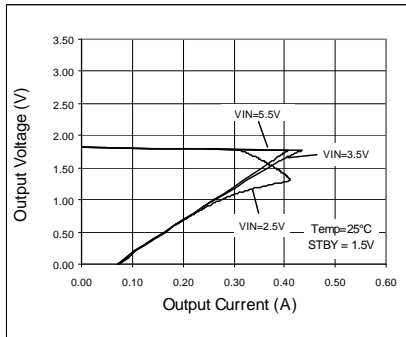

Fig. 41 OCP Threshold

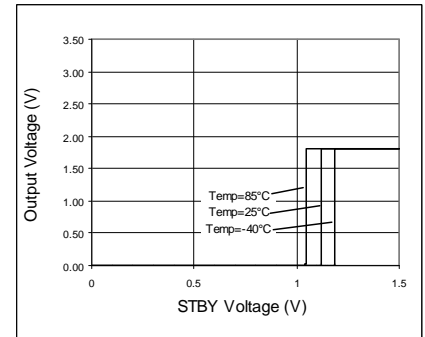

Fig. 42 STBY Threshold

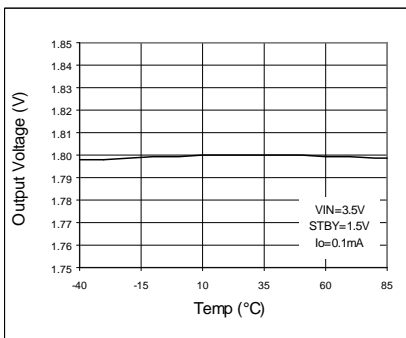

Fig. 43 VOUT vs Temp

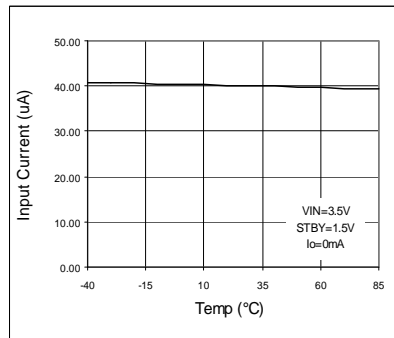

Fig. 44 IGND vs Temp

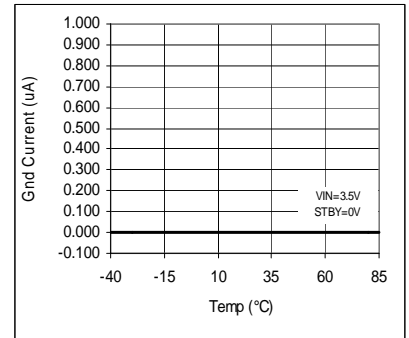

Fig. 45 IGND vs Temp (STBY)



●Reference data BU18TA2WNVX / HFV (Unless otherwise specified, Ta=25°C)

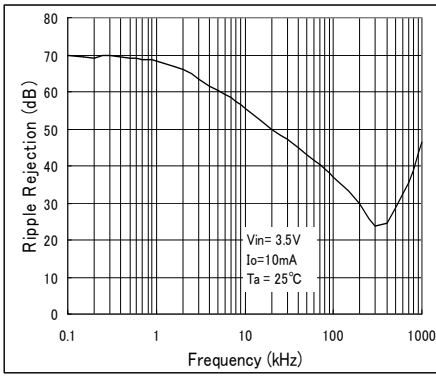

Fig. 46 Ripple Rejection VS Freq.

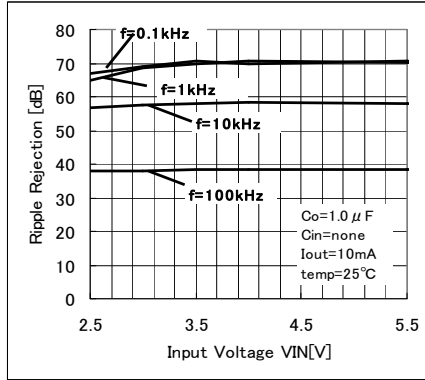

Fig. 47 Ripple Rejection VS VIN

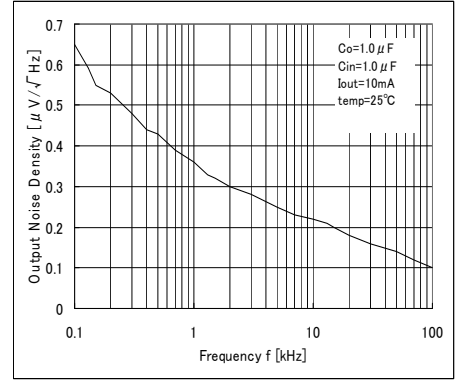

Fig. 48 Output Noise Spectrl Density VS Freq.

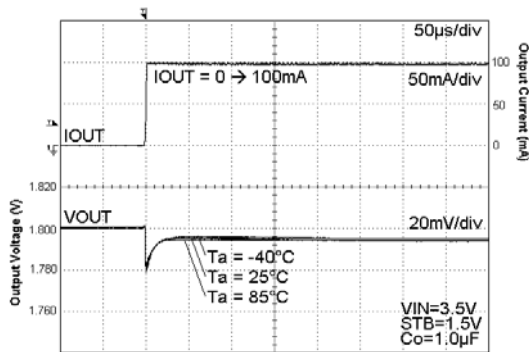

Fig. 49 Load Response

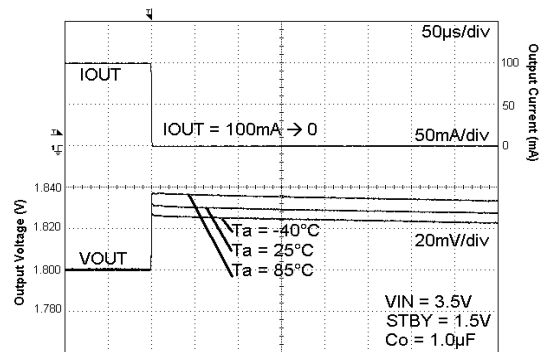

Fig. 50 Load Response

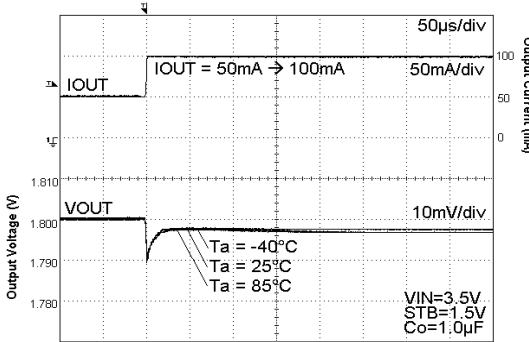

Fig. 51 Load Response

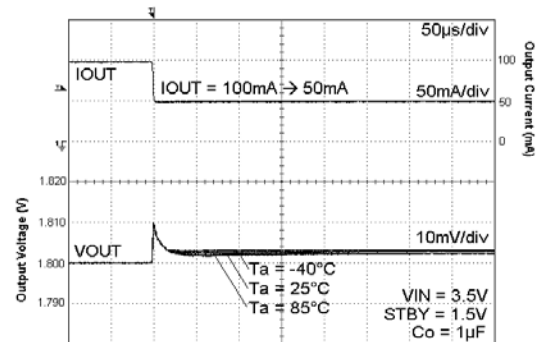

Fig. 52 Load Response

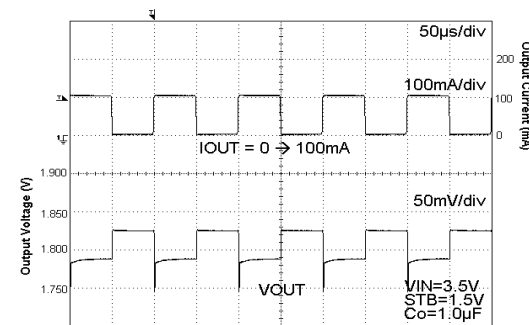

Fig. 53 Load Response  
Current Pulse=10kHz

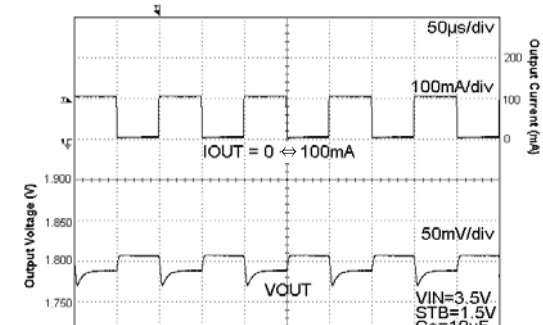

Fig. 54 Load Response  
Current Pulse=10kHz

●Reference data BU18TA2WNVX / HFV (Unless otherwise specified, Ta=25°C)

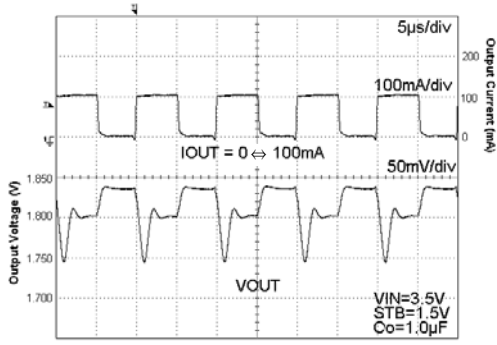

Fig. 55 Load Response  
Current Pulse=100kHz

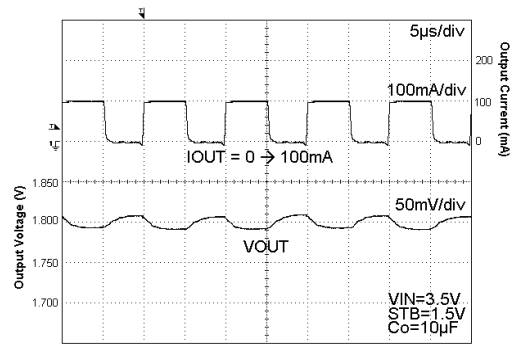

Fig. 56 Load Response  
Current Pulse=100kHz

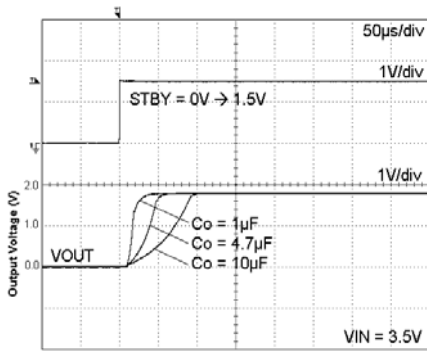

Fig. 57 Start Up Time  
Iout = 0mA

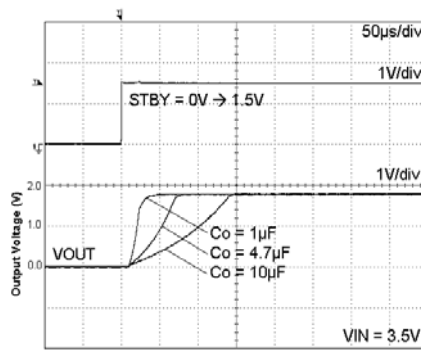

Fig. 58 Start Up Time  
Iout = 200mA

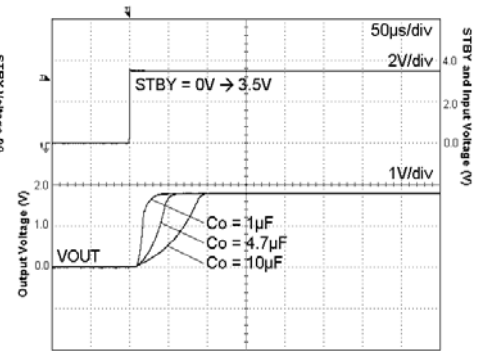

Fig. 59 Start Up Time (STBY=VIN)  
Iout = 0mA

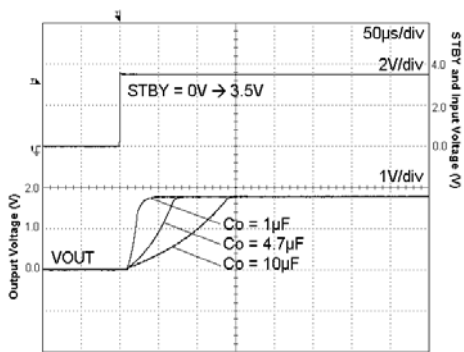

Fig. 60 Start Up Time(STBY=VIN)  
Iout = 200mA

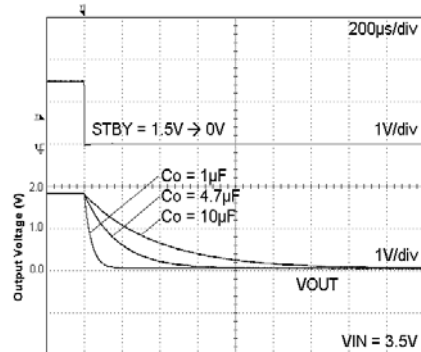

Fig. 61 Discharge Time  
Iout = 0mA

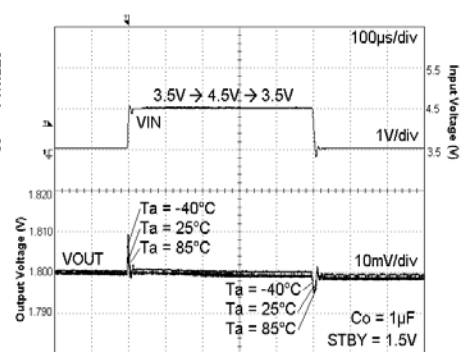

Fig. 62 VIN Response  
Iout = 10mA

●Reference data BU25TA2WNVX / HFV (Unless otherwise specified, Ta=25°C)

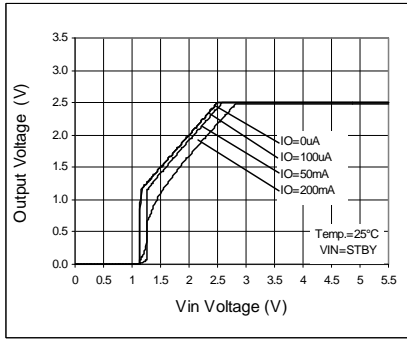

Fig. 63 Output Voltage

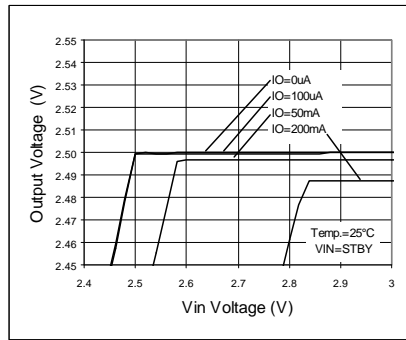

Fig. 64 Line Regulation

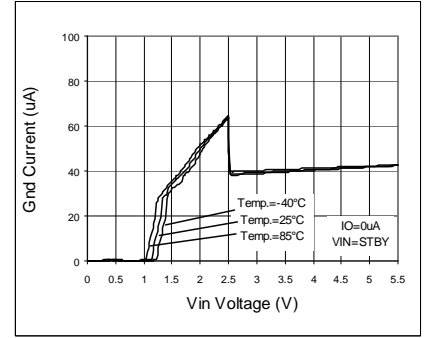

Fig. 65 Circuit Current IGND

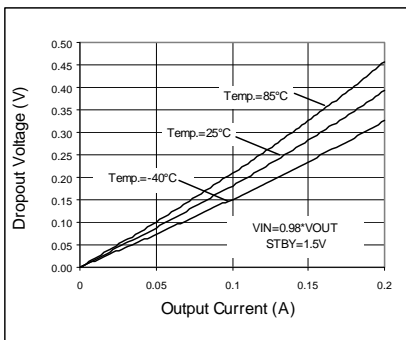

Fig. 66 Dropout Voltage

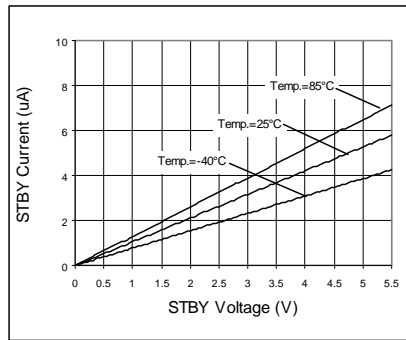

Fig. 67 STBY Input Current

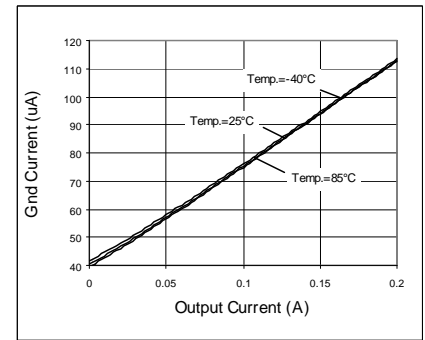

Fig. 68 IOU - IGND

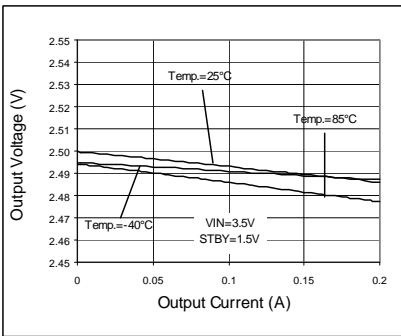

Fig. 69 Load Regulation

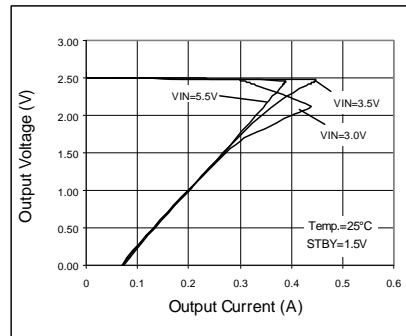

Fig. 70 OCP Threshold

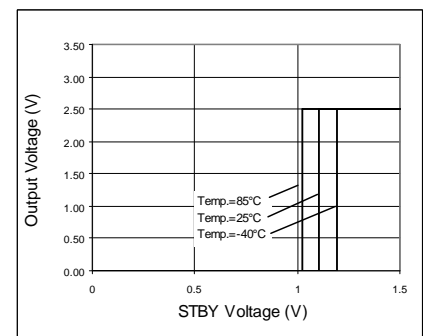

Fig. 71 STBY Threshold

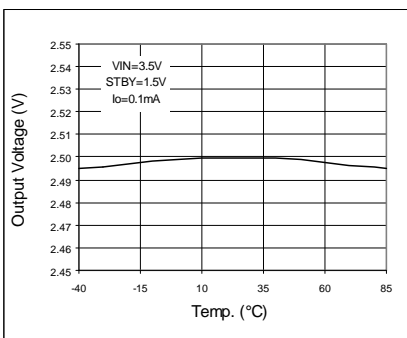

Fig. 72 VOUT vs Temp

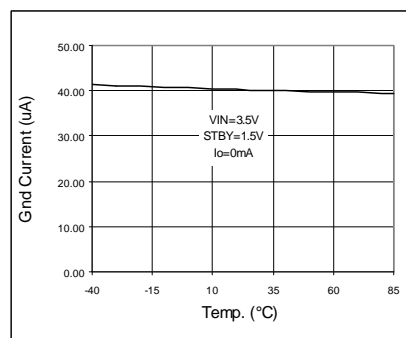

Fig. 73 IGND vs Temp

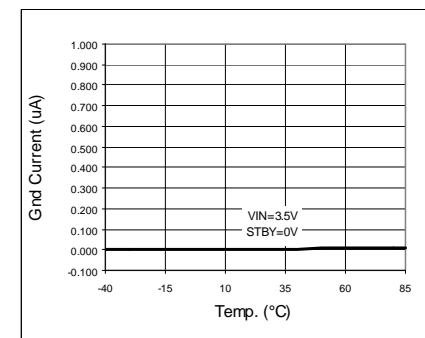

Fig. 74 IGND vs Temp (STBY)

●Reference data BU25TA2WNVX / HFV (Unless otherwise specified, Ta=25°C)

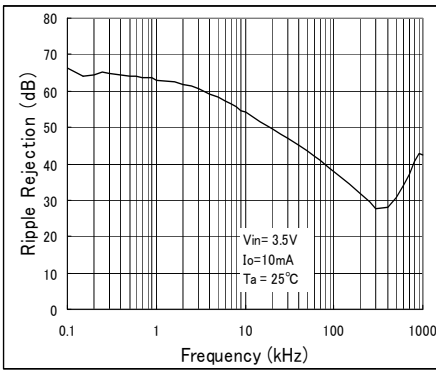

Fig. 75 Ripple Rejection VS Freq.

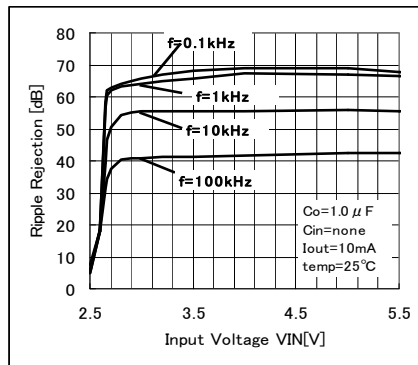

Fig. 76 Ripple Rejection VS VIN

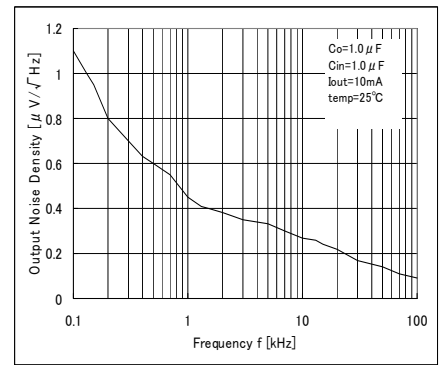

Fig. 77 Output Noise Spectral Density VS Freq.

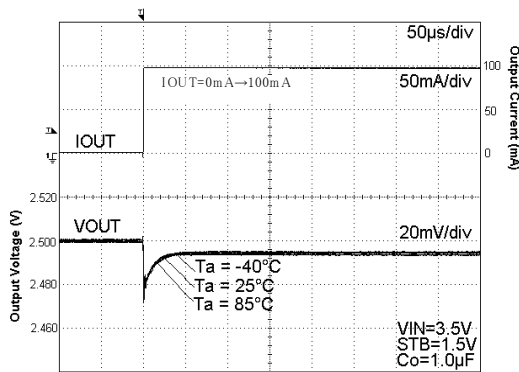

Fig. 78 Load Response

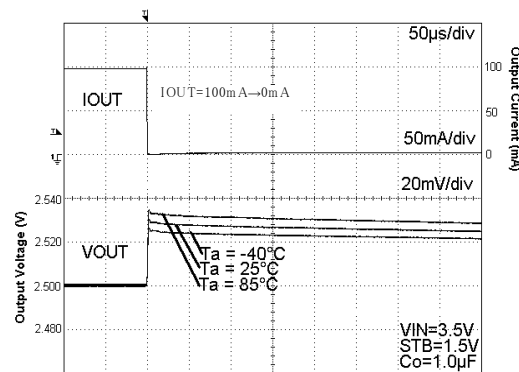

Fig. 79 Load Response

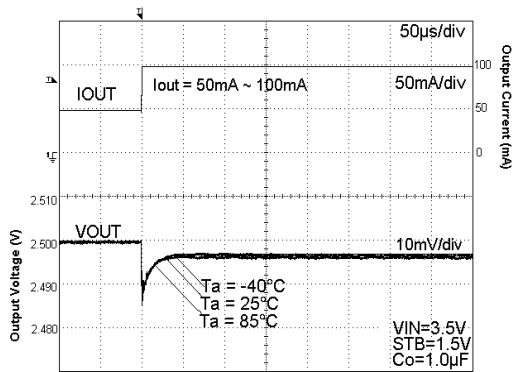

Fig. 80 Load Response

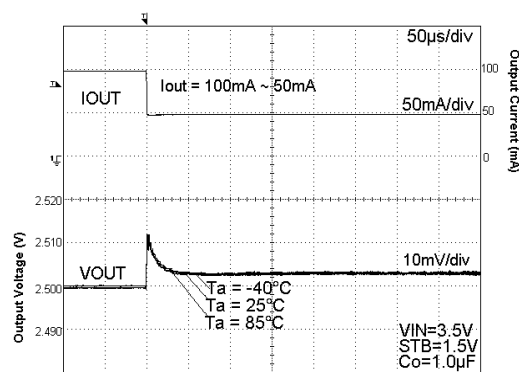

Fig. 81 Load Response

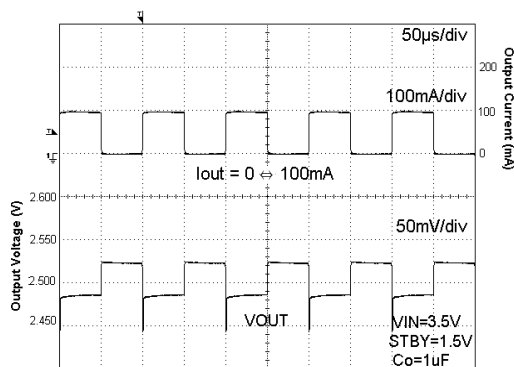

Fig. 82 Load Response  
Current Pulse=10kHz

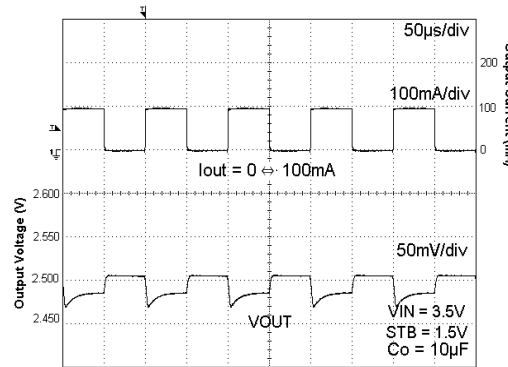

Fig. 83 Load Response  
Current Pulse=10kHz

●Reference data BU25TA2WNVX / HFV (Unless otherwise specified, Ta=25°C)

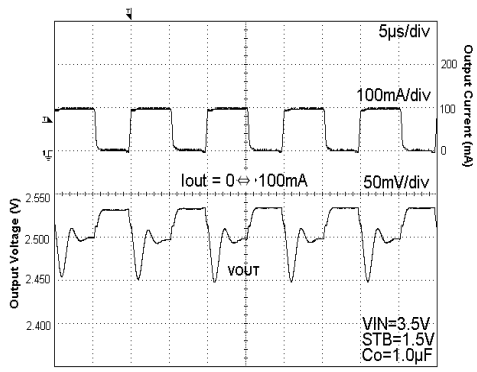

Fig. 84 Load Response  
Current Pulse=100kHz

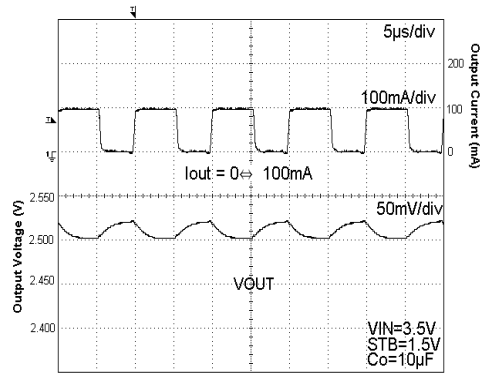

Fig. 85 Load Response  
Current Pulse=100kHz

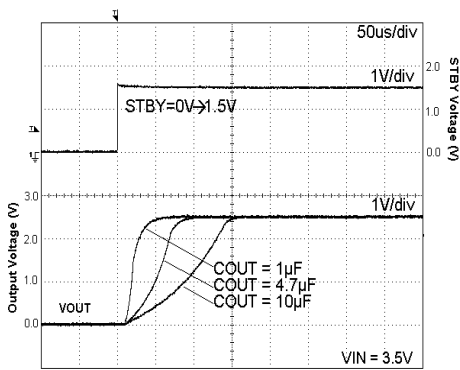

Fig. 86 Start Up Time  
Iout = 0mA

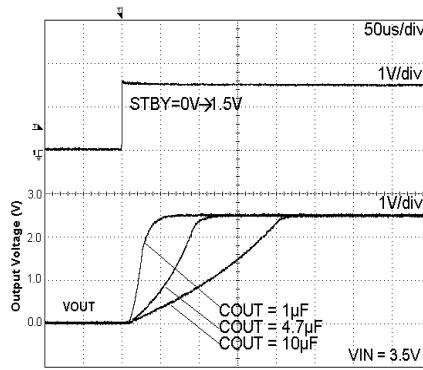

Fig. 87 Start Up Time  
Iout = 200mA

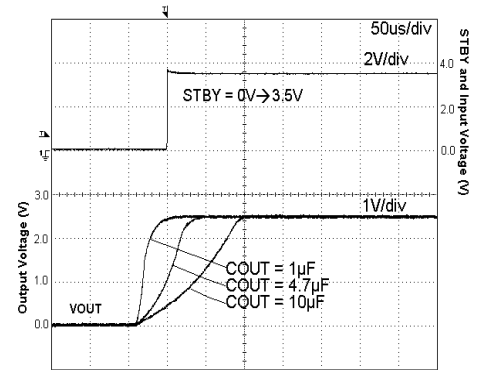

Fig. 88 Start Up Time (STBY=VIN)  
Iout = 0mA

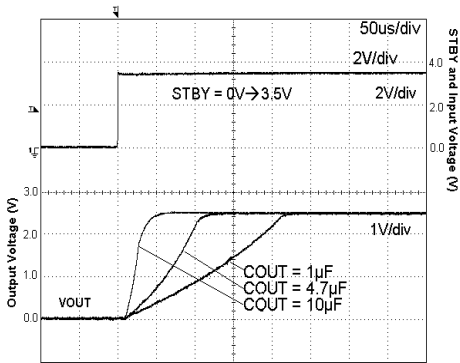

Fig. 89 Start Up Time (STBY=VIN)  
Iout = 200mA

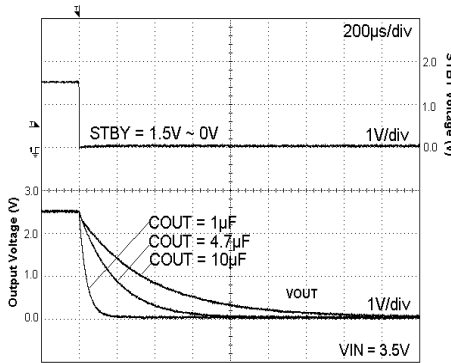

Fig. 90 Discharge Time  
Iout = 0mA

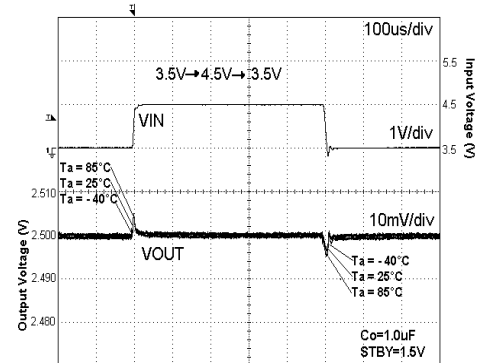

Fig. 91 VIN Response  
Iout = 10mA

●Reference data BU28TA2WNVX / HFV (Unless otherwise specified, Ta=25°C)

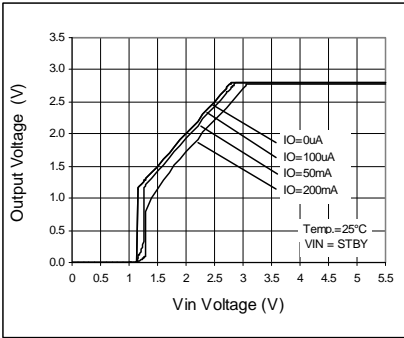

Fig. 92 Output Voltage

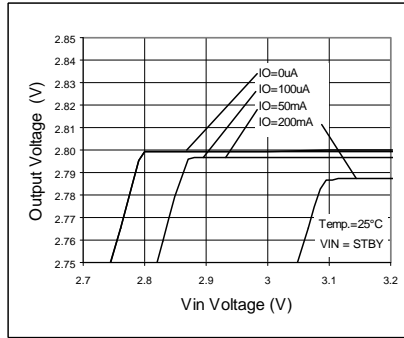

Fig. 93 Line Regulation

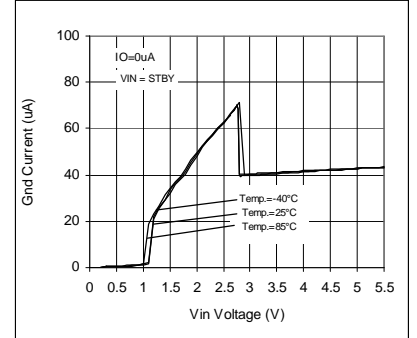

Fig. 94 Circuit Current IGND

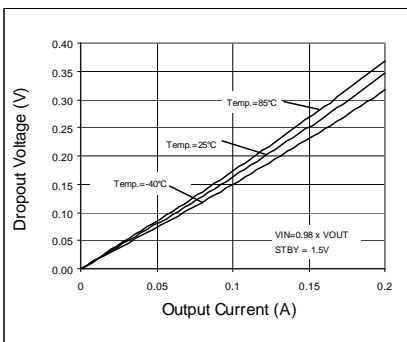

Fig. 95 Dropout Voltage

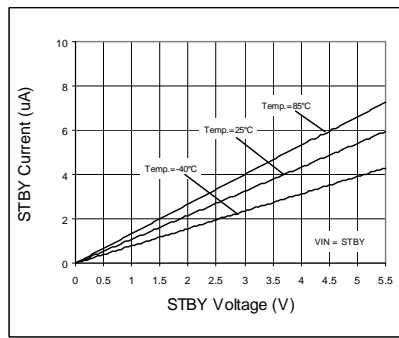

Fig. 96 STBY Input Current

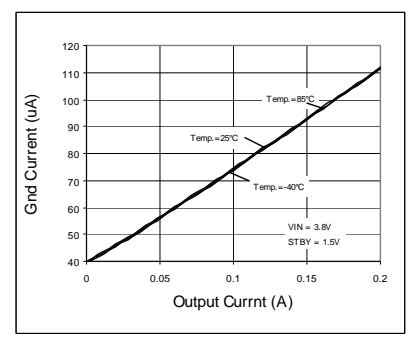

Fig. 97 IOOUT - IIGND

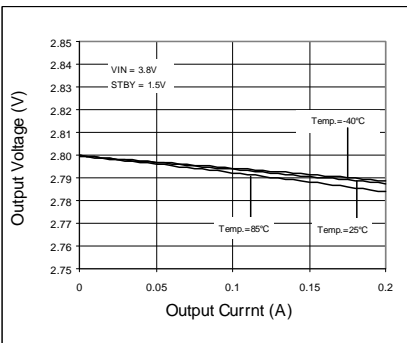

Fig. 98 Load Regulation

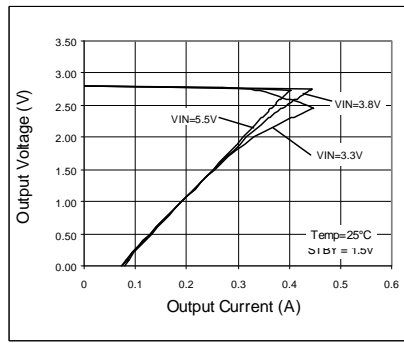

Fig. 99 OCP Threshold

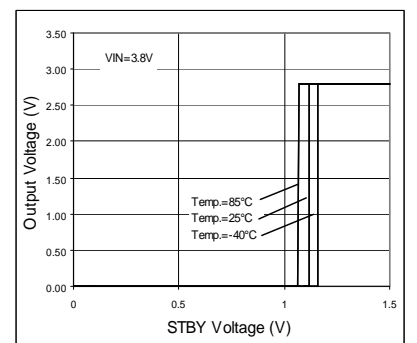

Fig. 100 STBY Threshold

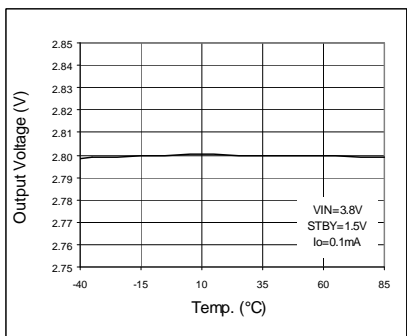

Fig. 101 VOUT vs Temp

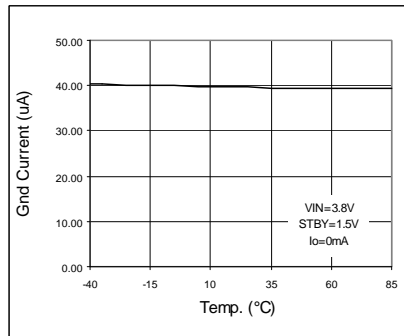

Fig. 102 IIGND vs Temp

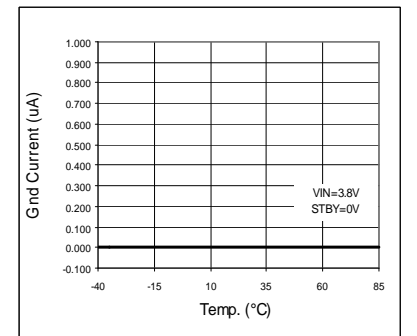

Fig. 103 IIGND vs Temp (STBY)

●Reference data BU28TA2WNVX / HFV (Unless otherwise specified, Ta=25°C)

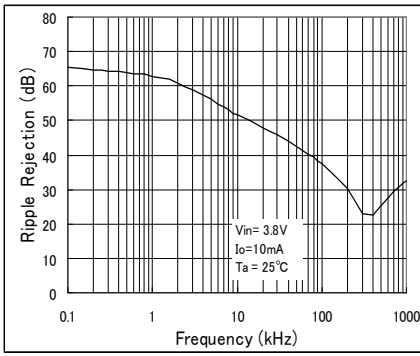

Fig. 104 Ripple Rejection VS Freq.

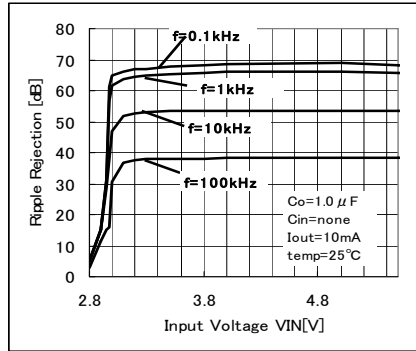

Fig. 105 Ripple Rejection VS VIN

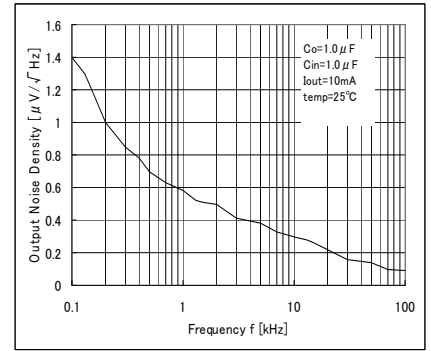

Fig. 106 Output Noise Spectral Density VS Freq.

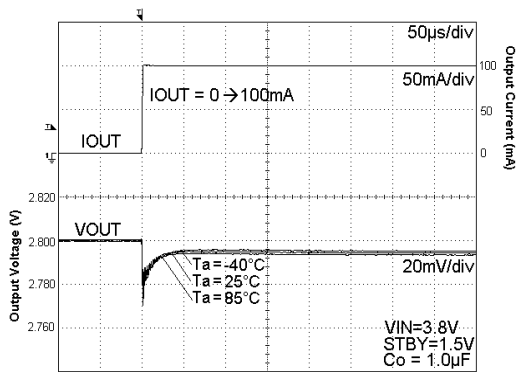

Fig. 107 Load Response

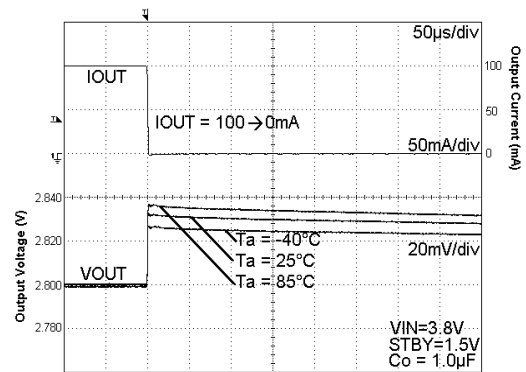

Fig. 108 Load Response

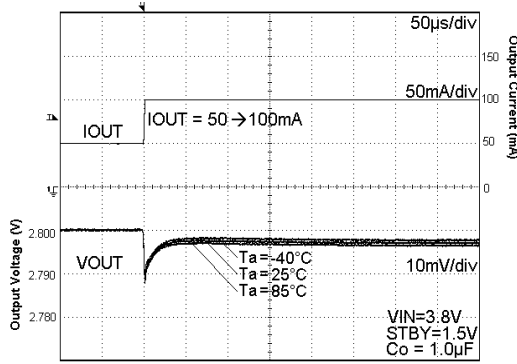

Fig. 109 Load Response

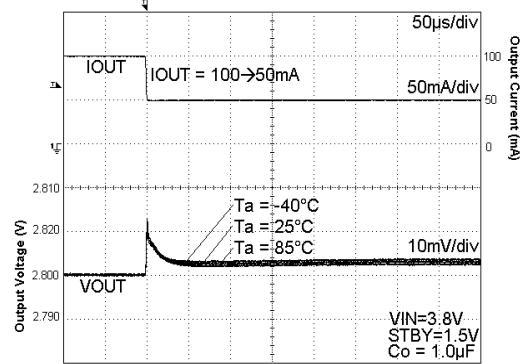

Fig. 110 Load Response

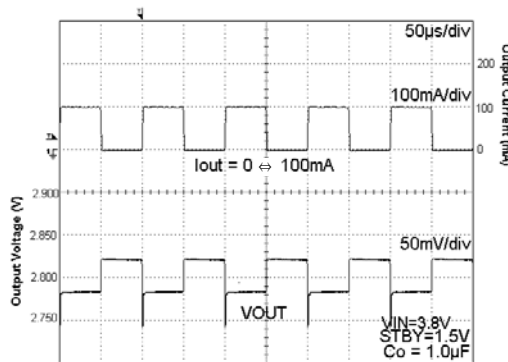

Fig. 111 Load Response  
Current Pulse=10kHz

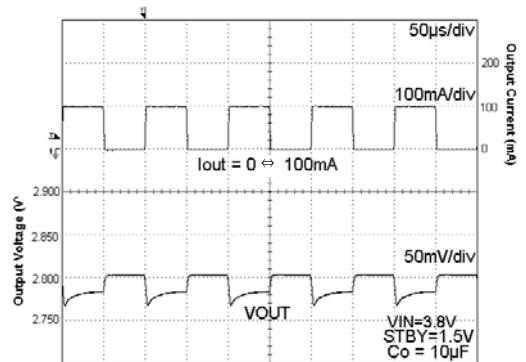

Fig. 112 Load Response  
Current Pulse=10kHz

●Reference data BU28TA2WNVX / HFV (Unless otherwise specified, Ta=25°C)

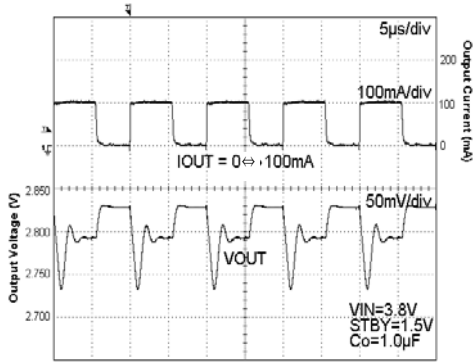

Fig. 113 Load Response  
Current Pulse=100kHz

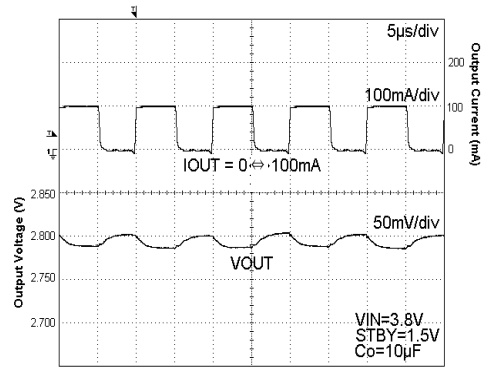

Fig. 114 Load Response  
Current Pulse=100kHz

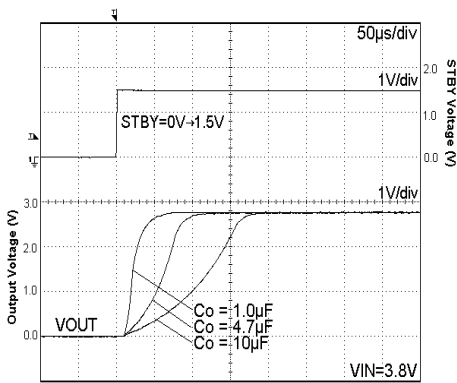

Fig. 115 Start Up Time  
Iout = 0mA

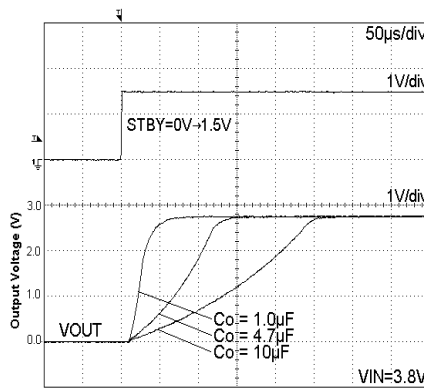

Fig. 116 Start Up Time  
Iout = 200mA

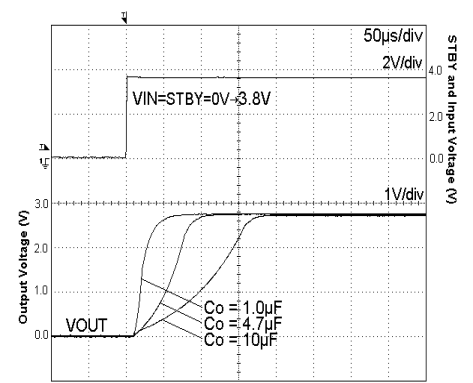

Fig. 117 Start Up Time (STBY=VIN)  
Iout = 0mA

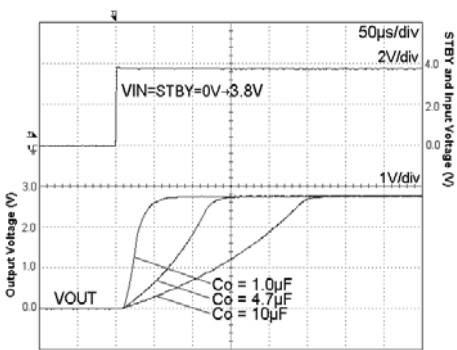

Fig. 118 Start Up Time(STBY=VIN)  
Iout = 200mA

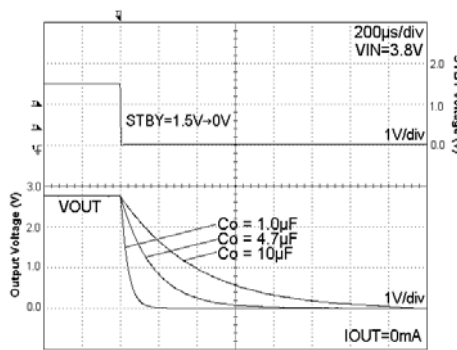

Fig. 119 Discharge Time  
Iout = 0mA

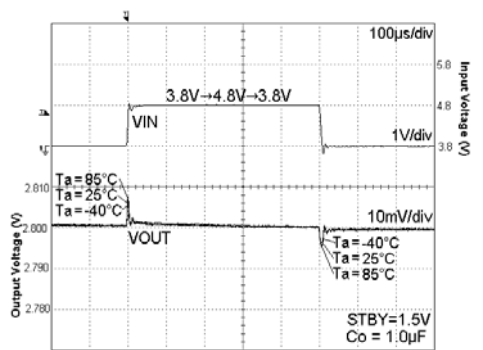

Fig.120 VIN Response  
Iout = 10mA



●Reference data BU30TA2WNVX / HFV (Unless otherwise specified, Ta=25°C)

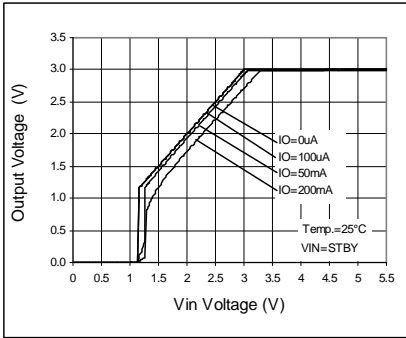

Fig. 121 Output Voltage

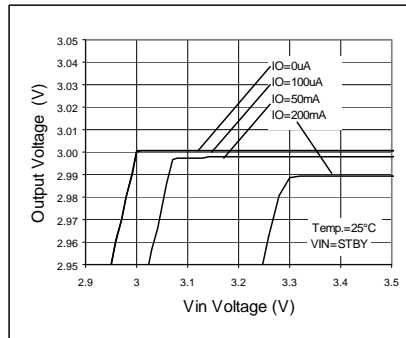

Fig. 122 Line Regulation

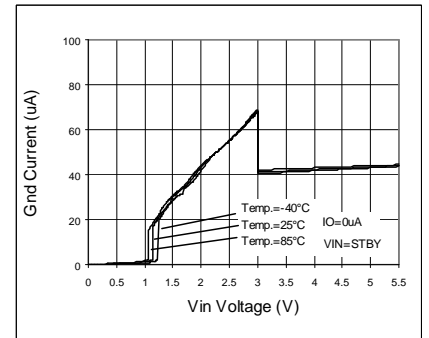

Fig. 123 Circuit Current IGND

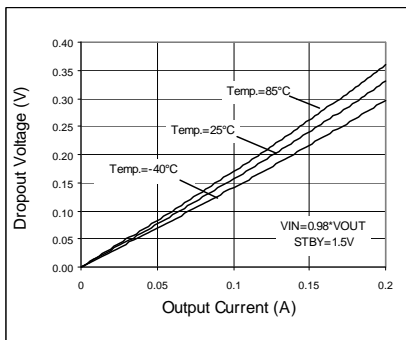

Fig. 124 Dropout Voltage

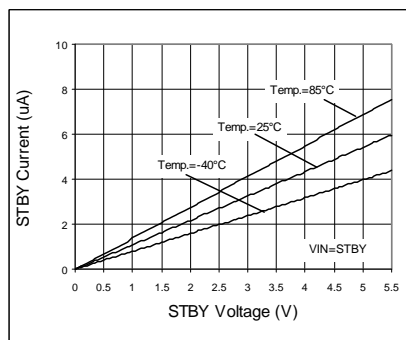

Fig. 125 STBY Input Current

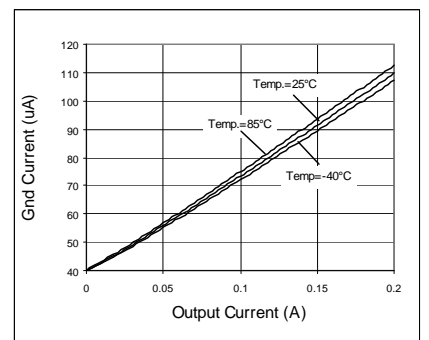

Fig. 126 IOU - IGND

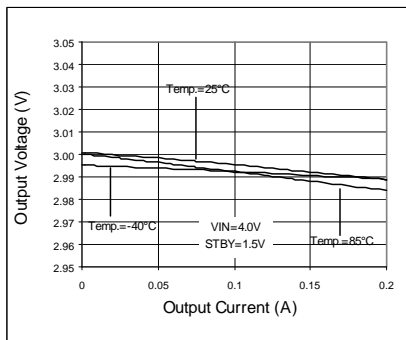

Fig. 127 Load Regulation

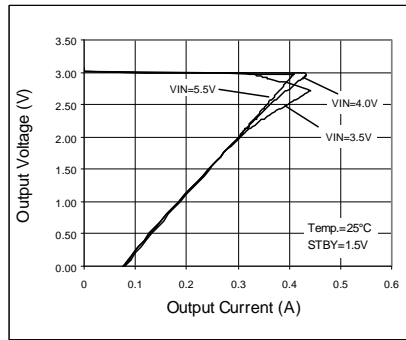

Fig. 128 OCP Threshold

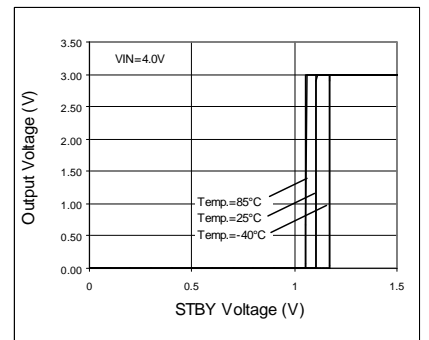

Fig. 129 STBY Threshold

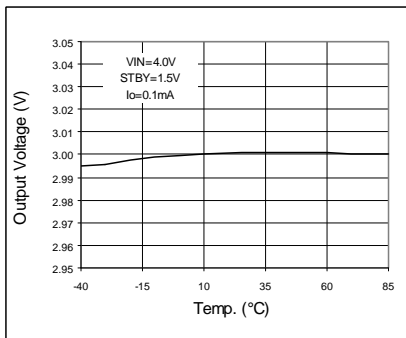

Fig. 130 VOUT vs Temp

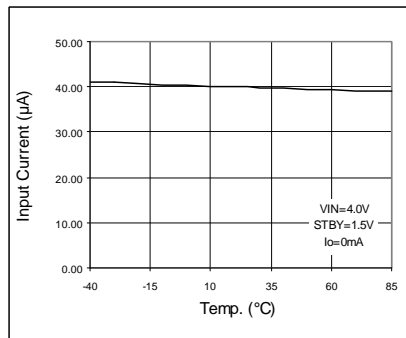

Fig. 131 IGND vs Temp

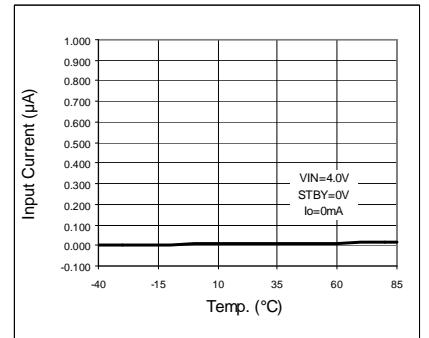

Fig. 132 IGND vs Temp (STBY)

●Reference data BU30TA2WNVX / HFV (Unless otherwise specified, Ta=25°C)

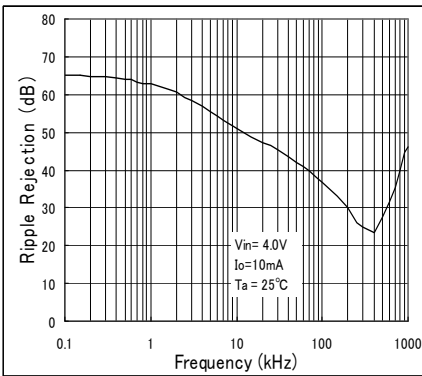

Fig. 133 Ripple Rejection VS Freq.

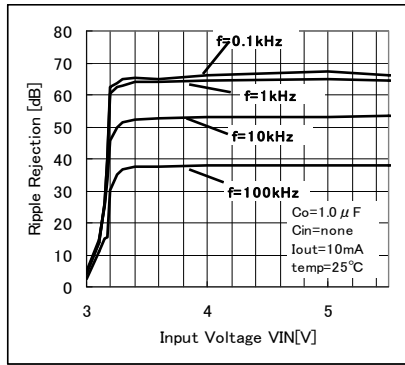

Fig. 134 Ripple Rejection VS VIN

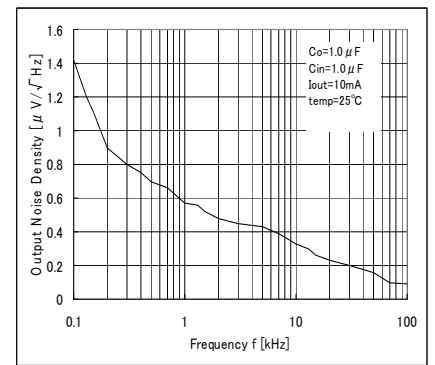

Fig. 135 Output Noise Spectral Density VS Freq.

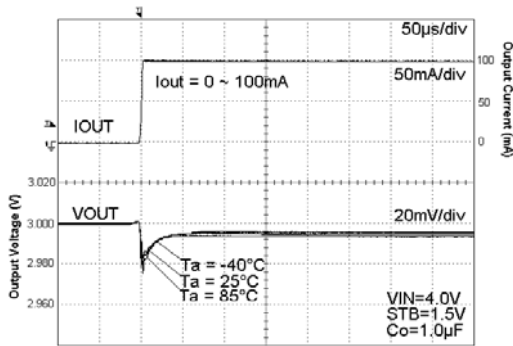

Fig. 136 Load Response

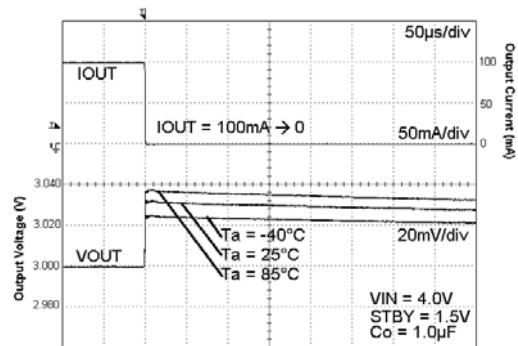

Fig. 137 Load Response

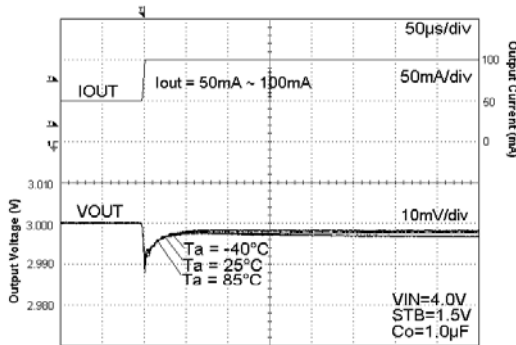

Fig. 138 Load Response

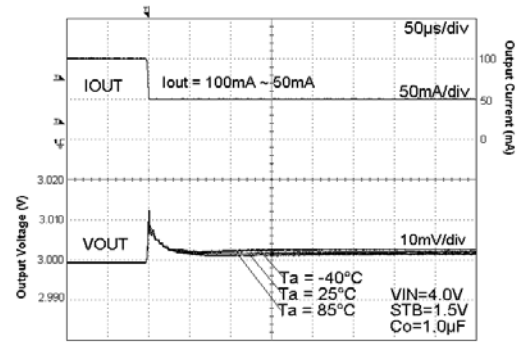

Fig. 139 Load Response

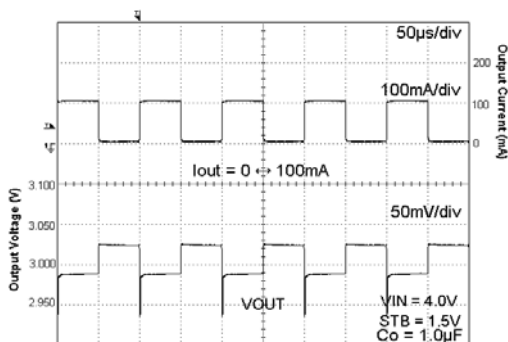

Fig. 140 Load Response  
Current Pulse=10kHz

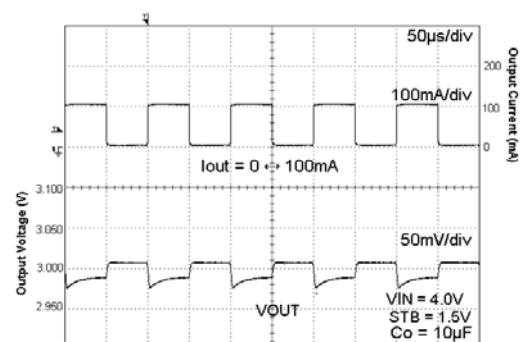

Fig. 141 Load Response  
Current Pulse=10kHz

●Reference data BU30TA2WNVX / HFV (Unless otherwise specified, Ta=25°C)

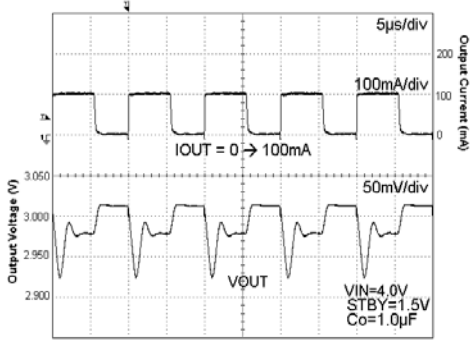

Fig. 142 Load Response  
Current Pulse=100kHz

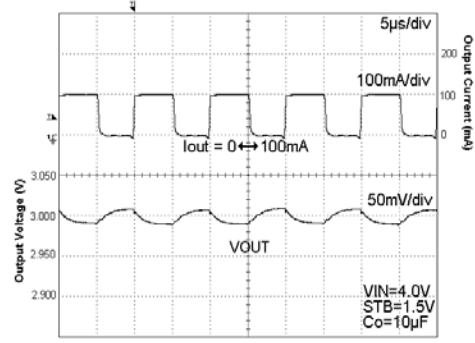

Fig. 143 Load Response  
Current Pulse=100kHz

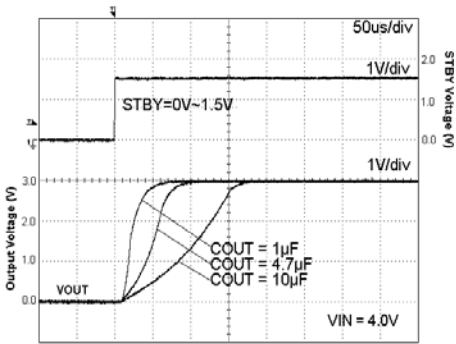

Fig. 144 Start Up Time  
Iout = 0mA

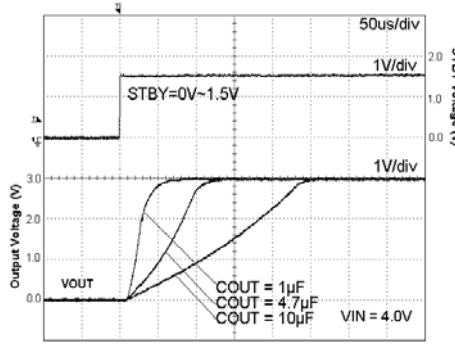

Fig. 145 Start Up Time  
Iout = 200mA

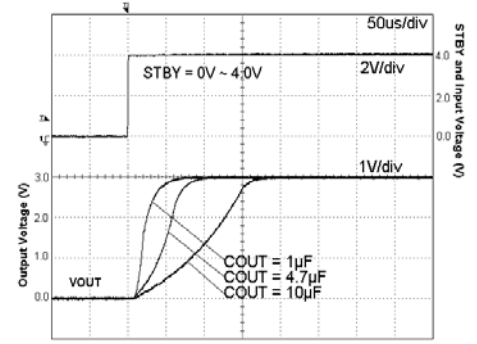

Fig. 146 Start Up Time (STBY=VIN)  
Iout = 0mA

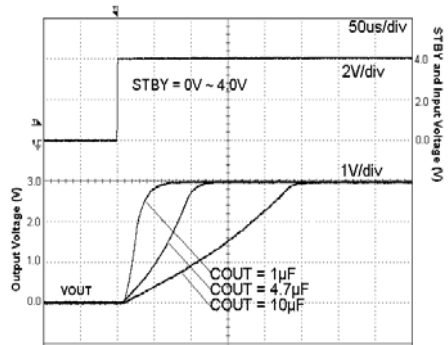

Fig. 147 Start Up Time(STBY=VIN)  
Iout = 200mA

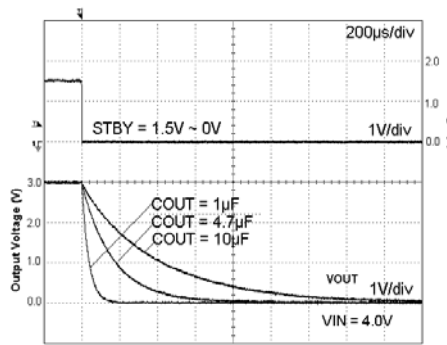

Fig. 148 Discharge Time  
Iout = 0mA

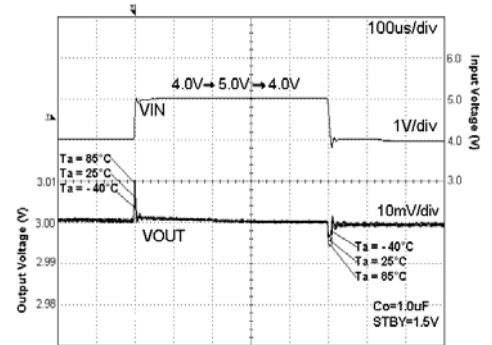

Fig. 149 VIN Response  
Iout = 10mA

●Reference data BU33TA2WNVX / HFV (Unless otherwise specified, Ta=25°C)

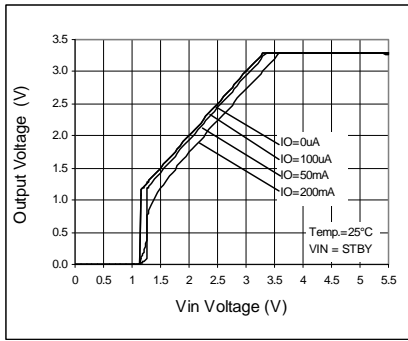

Fig. 150 Output Voltage

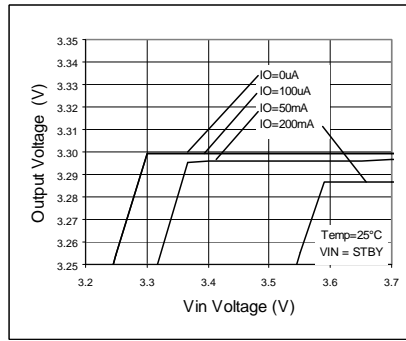

Fig. 151 Line Regulation

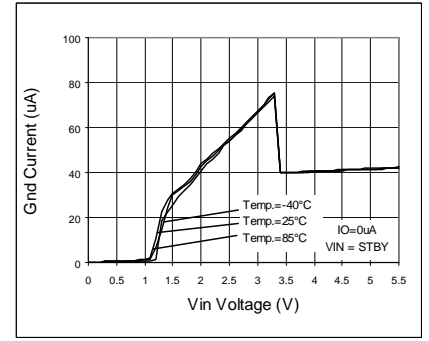

Fig. 152 Circuit Current IGND

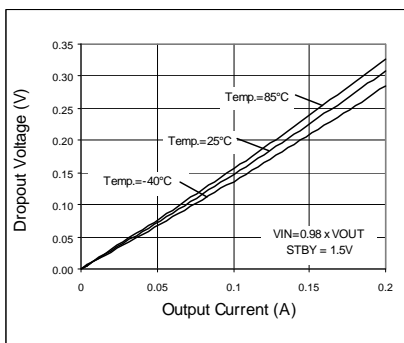

Fig. 153 Dropout Voltage

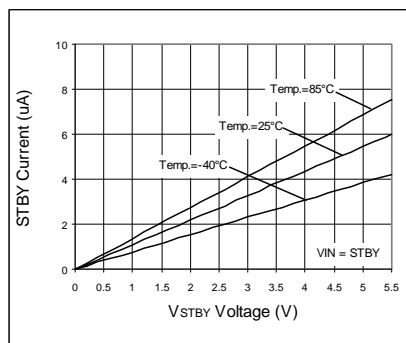

Fig. 154 STBY Input Current

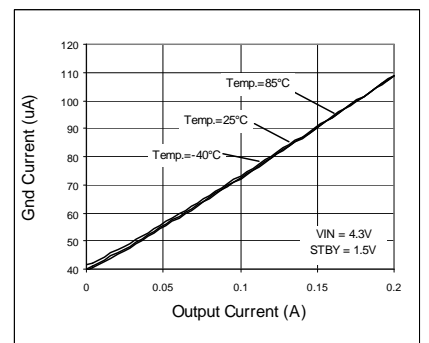

Fig. 155 IOUT - IGDND

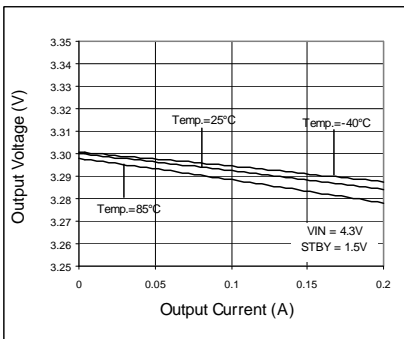

Fig. 156 Load Regulation

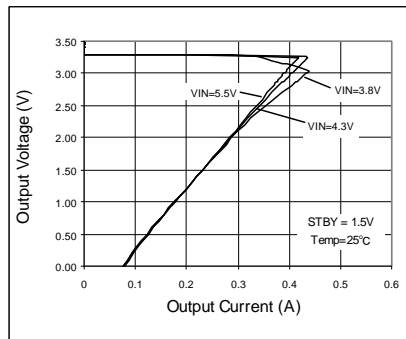

Fig. 157 OCP Threshold

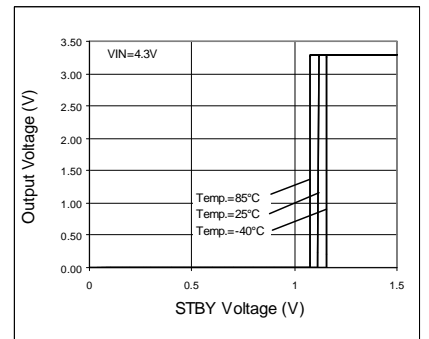

Fig. 158 STBY Threshold

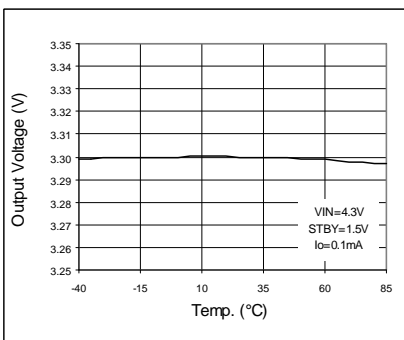

Fig. 159 VOUT vs Temp

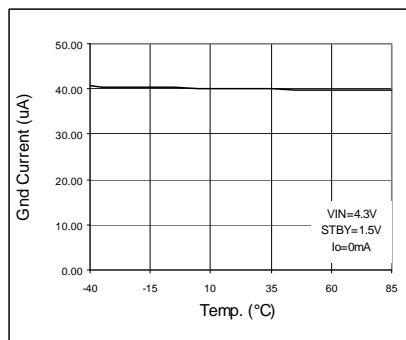

Fig. 160 IGDND vs Temp

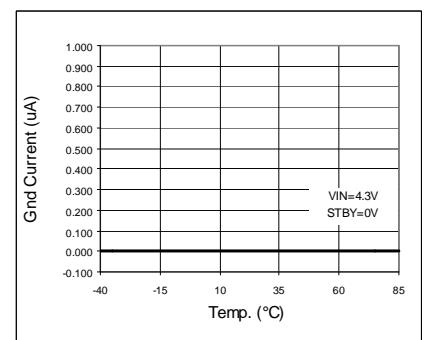

Fig. 161 IGDND vs Temp (STBY)

●Reference data BU33TA2WNVX / HFV (Unless otherwise specified, Ta=25°C)

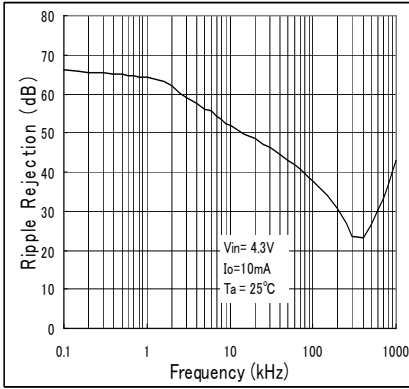

Fig. 162 Ripple Rejection VS Freq.

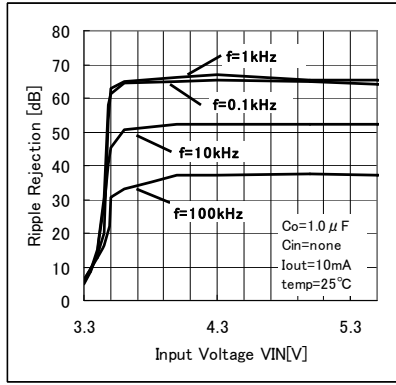

Fig. 163 Ripple Rejection VS VIN

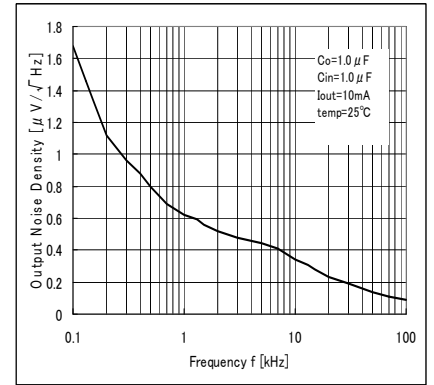

Fig. 164 Output Noise Spectrl Density VS Freq.

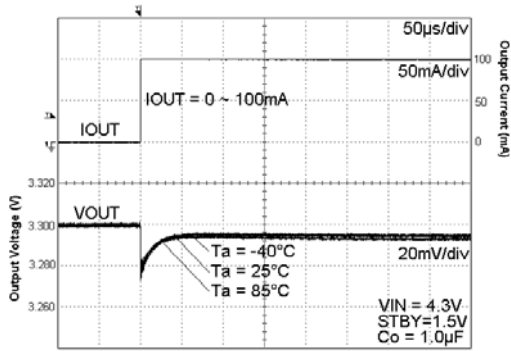

Fig. 165 Load Response

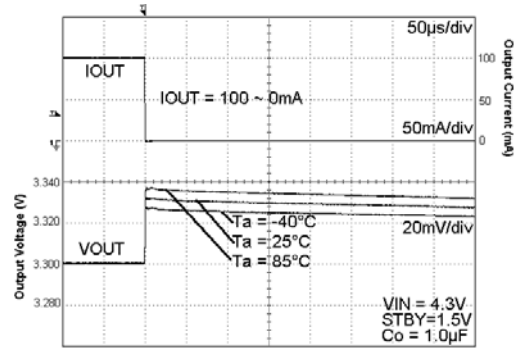

Fig. 166 Load Response

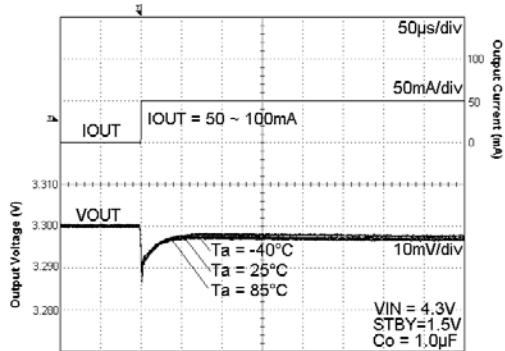

Fig. 167 Load Response

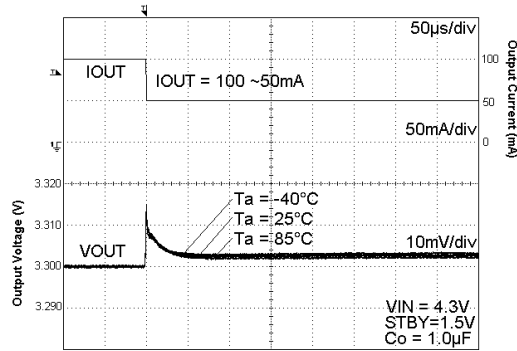

Fig. 168 Load Response

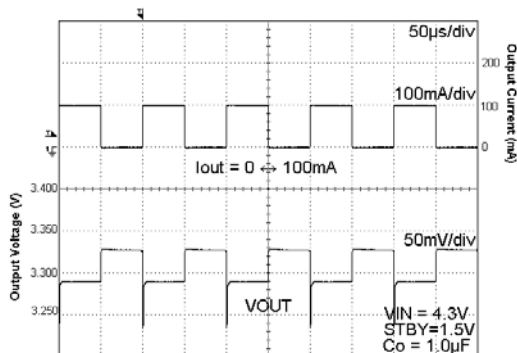

Fig. 169 Load Response Current Pulse=10kHz

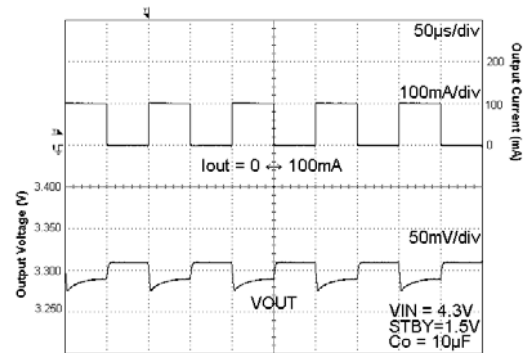

Fig. 170 Load Response Current Pulse=10kHz

●Reference data BU33TA2WNVX / HFV (Unless otherwise specified, Ta=25°C)

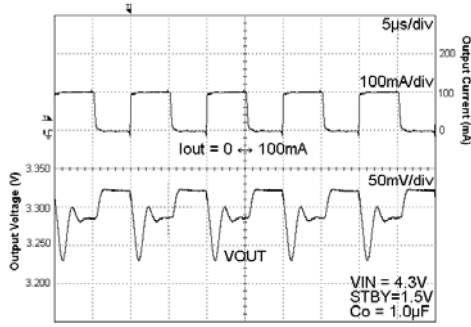

Fig. 171 Load Response  
Current Pulse=100kHz

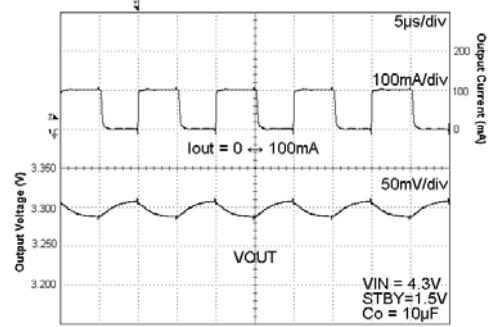

Fig. 172 Load Response  
Current Pulse=100kHz

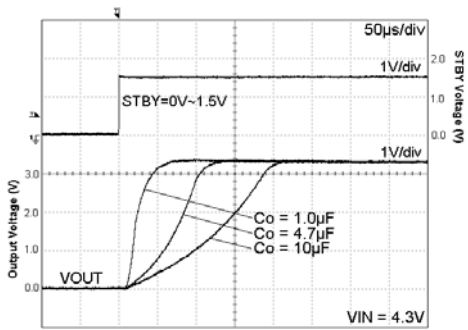

Fig. 173 Start Up Time  
Iout = 0mA

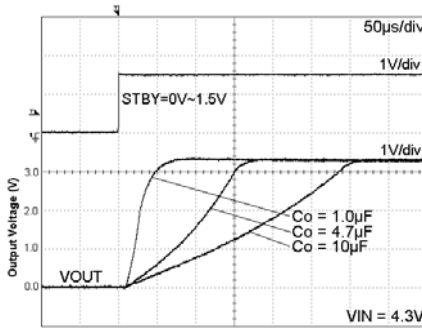

Fig. 174 Start Up Time  
Iout = 200mA

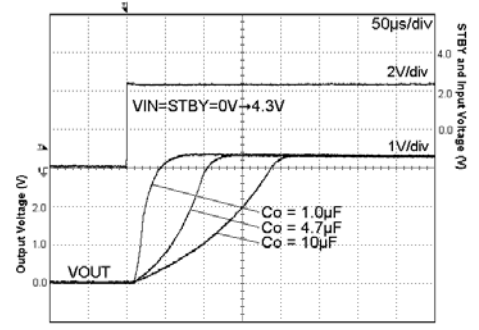

Fig. 175 Start Up Time (STBY=VIN)  
Iout = 0mA

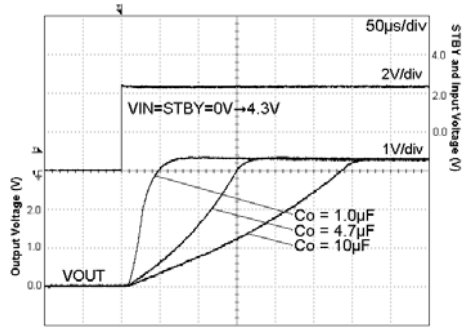

Fig. 176 Start Up Time(STBY=VIN)  
Iout = 200mA

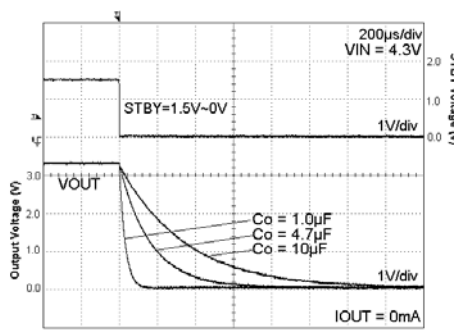

Fig. 177 Discharge Time  
Iout = 0mA

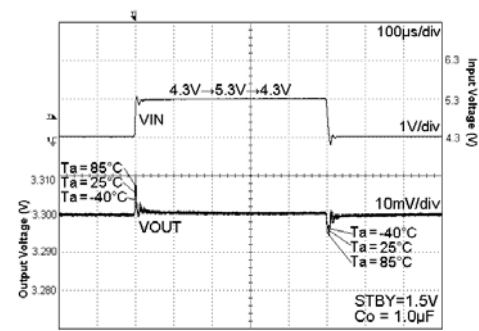

Fig. 178 VIN Response  
Iout = 10mA

● About power dissipation (Pd)

As for power dissipation, an approximate estimate of the heat reduction characteristics and internal power consumption of IC are shown, so please use these for reference. Since power dissipation changes substantially depending on the implementation conditions (board size, board thickness, metal wiring rate, number of layers and through holes, etc.), it is recommended to measure Pd on a set board. Exceeding the power dissipation of IC may lead to deterioration of the original IC performance, such as causing operation of the thermal shutdown circuit or reduction in current capability. Therefore, be sure to prepare sufficient margin within power dissipation for usage.

Calculation of the maximum internal power consumption of IC (P<sub>MAX</sub>)

$$P_{MAX} = (V_{IN} - V_{OUT}) \times I_{OUT(MAX)}$$

(V<sub>IN</sub>: Input voltage V<sub>OUT</sub>: Output voltage I<sub>OUT(MAX)</sub>: Maximum output current)

○ SSON004X1216

Measurement conditions

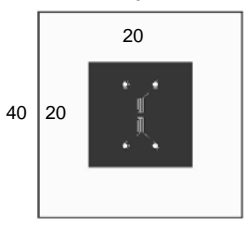
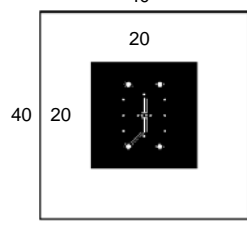
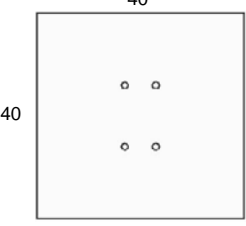
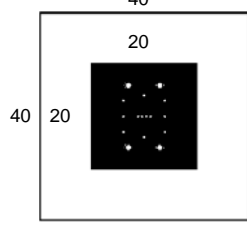
	Evaluation Board 1 (Single-side Board)	Evaluation Board 2 (Double-side Board)
Layout of Board for Measurement (Unit: mm)		
		
Measurement State	With board implemented (Wind speed 0 m/s)	With board implemented (Wind speed 0 m/s)
Board Material	Glass epoxy resin (Single-side board)	Glass epoxy resin (Double-side board)
Board Size	40 mm x 40 mm x 0.8 mm	40 mm x 40 mm x 0.8 mm
Wiring Rate	Top layer	Metal (GND) wiring rate: Approx. 25%
	Bottom layer	Metal (GND) wiring rate: Approx 0%
Through Hole	0 holes	Diameter 0.5 mm × 12 holes
Power Dissipation	1100 mW	1250 mW
Thermal Resistance	θ <sub>ja</sub> =91°C/W	θ <sub>ja</sub> =80°C/W

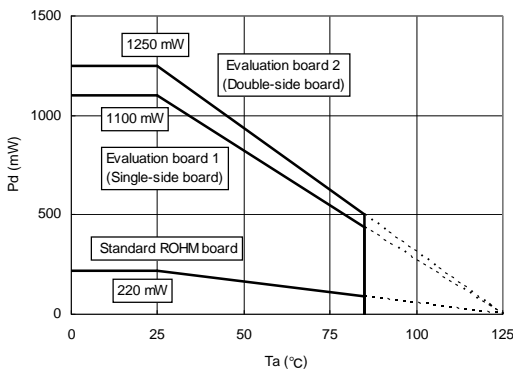

\* Please design the margin so that P<sub>MAX</sub> becomes is than Pd (P<sub>MAX</sub><Pd) within the usage temperature range.

- Standard ROHM board -  
Size: 70 mm × 70 mm × 1.6 mm  
Material: Glass epoxy board

Fig.179 SSON004X1216 Power dissipation heat reduction characteristics (Reference)

○ HVSO5

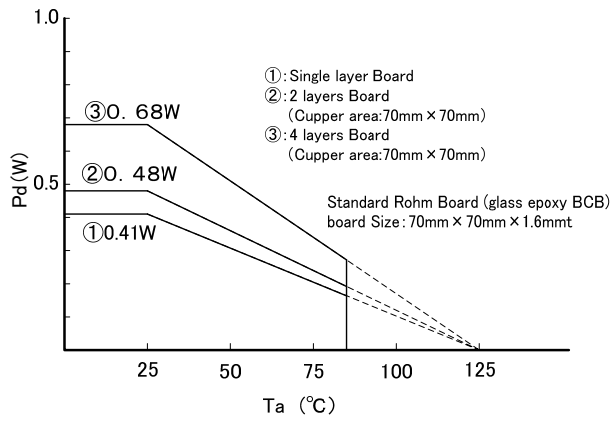

\* Please design the margin so that P<sub>MAX</sub> becomes is than Pd (P<sub>MAX</sub><Pd) within the usage temperature range.

Fig.180 HVSO5 Power dissipation heat reduction characteristics (Reference)

● DEVICE TYPE & Mark

OSSON004X1216

OHVSO5

Device type: **BUXXTA2WNVX**  
 ↑  
 a

Device type: **BUXXTA2WHFV**  
 ↑  
 a

	XX	output voltage	package	
			SSON004 X1216	HVSO5
a	15	1.5V typ.	AA	BA
	18	1.8V typ.	AB	BB
	23	2.3V typ.	AG	BC
	25	2.5V typ.	AC	BD
	26	2.6V typ.	AD	BE
	27	2.7V typ.	AE	BF
	28	2.8V typ.	AF	BG
	2J	2.85V typ.	AG	BH
	29	2.9V typ.	AH	BJ
	30	3.0V typ.	AJ	BK
	31	3.1V typ.	AK	BL
	32	3.2V typ.	AL	BM
	33	3.3V typ.	AM	BN
	34	3.4V typ.	AN	BP



○ SSON004X1216

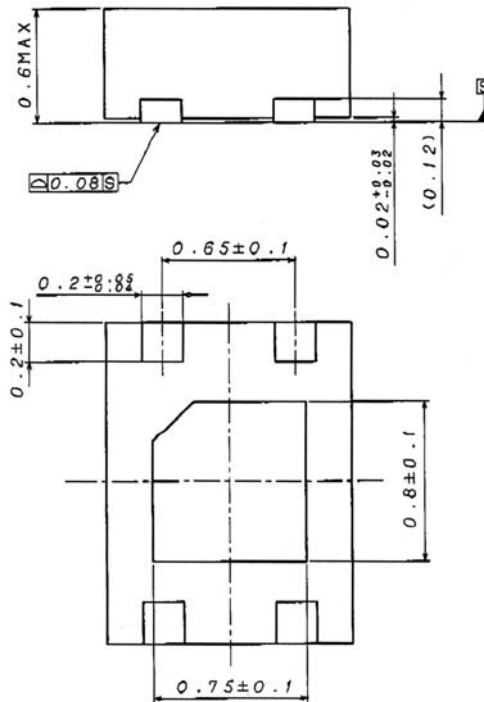
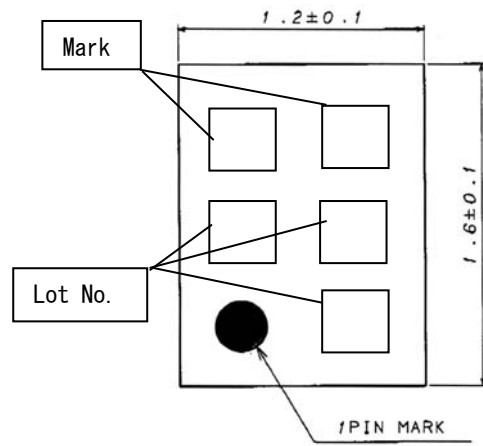

○ HVSOF5

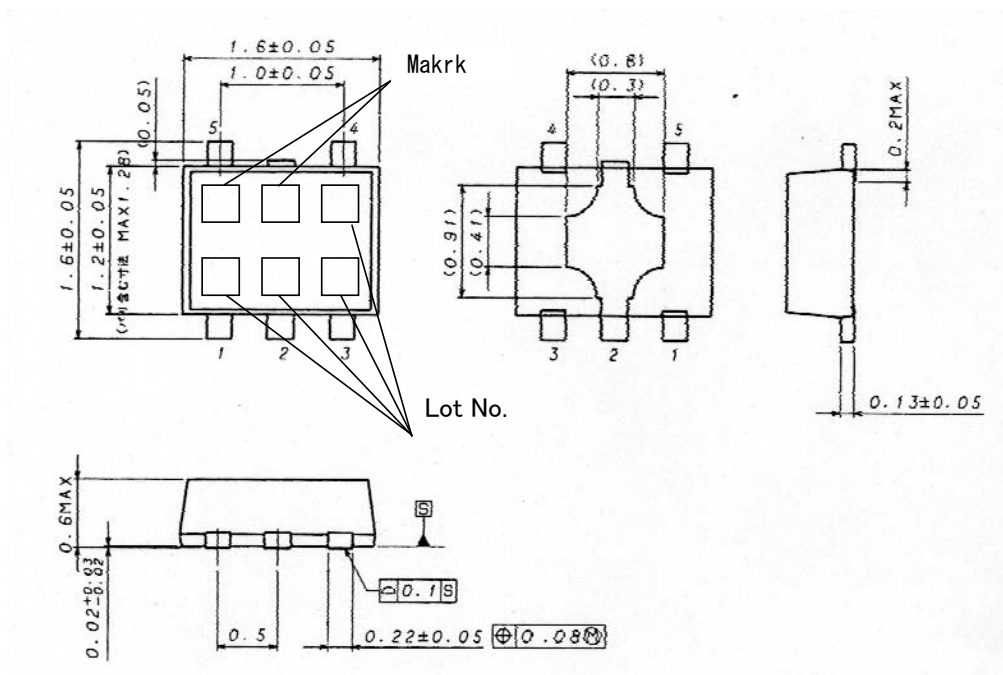

- Other notes

- About absolute maximum rating

Breakage may occur when absolute maximum ratings such as applied voltage and operating temperature range are exceeded. Short mode or open mode cannot be specified at occurrence of a break, so please prepare physical safety measures (e.g., fuse) if such special mode in which the absolute maximum rating is exceeded can be assumed.

- About GND potential

Please be sure that the potential of the GND terminal is the lowest in any operating condition.

- About thermal design

Please provide thermal design with sufficient margin, taking power dissipation (Pd) in actual usage conditions into consideration.

- About short between pins and misattachment

Please be careful regarding the IC direction and misalignment at attachment onto a printed circuit board. Misattachment may cause a break of IC. Short caused by foreign matter between outputs, output and power supply, or GNDs may also lead to a break.

- About operation in a strong electromagnetic field

Please note that usage in a strong electromagnetic field may cause malfunction.

- About common impedance

**Please give due consideration to wiring of the power source and GND by reducing common-mode ripple or making ripple as small as possible (e.g., making the wiring as thick and short as possible, or reducing ripple by L-C), etc.**

- About STBY terminal voltage

Set STBY terminal voltage to 0.3 V or less to put each channel into a standby state and to 1.5 V or more to put each channel into an operating state. Do not fix STBY terminal voltage to 0.3 V or more and 1.5 V or less or do not lengthen the transition time. This may cause malfunction or failure.

When shorting the VIN terminal and STBY terminal for usage, the status will be "STBY=VIN=LOW" at turning the power OFF, and discharge of the VOUT terminal cannot operate, which means voltage may remain for a certain time in the VOUT terminal. Since turning the power ON again in this state may cause overshoot, turn the power ON for use after the VOUT terminal is completely discharged.

- About overcurrent protection circuit

Output has a built-in overcurrent protection circuit, which prevents IC break at load short. Note that this protection circuit is effective for prevention of breaks due to unexpected accidents. Please avoid usage by which the protection circuit operates continuously.

- About thermal shutdown

Output is OFF when the thermal circuit operates since a temperature protection circuit is built in to prevent thermal breakdown. However, it recovers when the temperature returns to a certain temperature. The thermal circuit operates at emergency such as overheating of IC. Since it is prepared to prevent IC breakdown, please do not use it in a state in which protection works.

- About reverse current

For applications on which reverse current is assumed to flow into IC, it is recommended to prepare a path to let the current out by putting a bypass diode between the VIN-VOUT terminals.

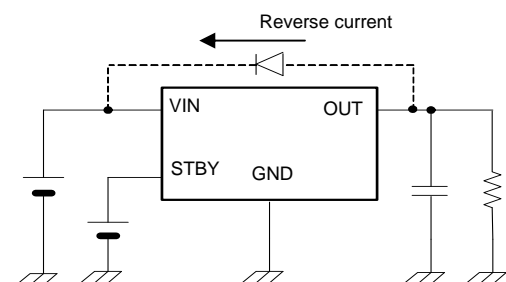
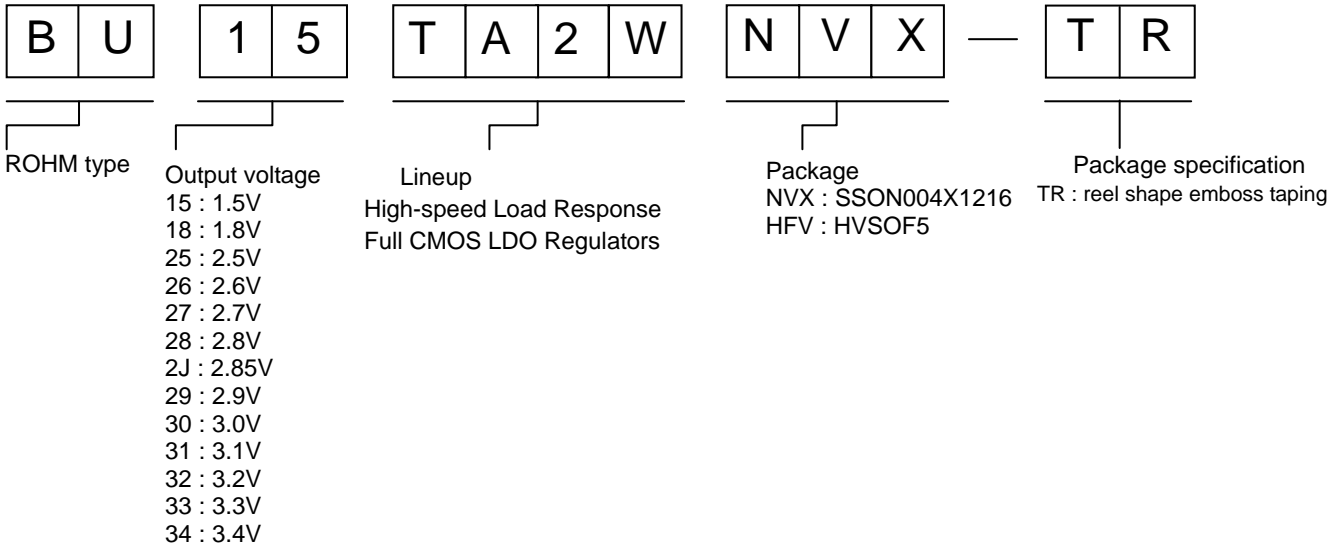

Fig.181 Example of bypass diode connection

- About testing on a set board

When connecting a capacitor to a terminal with low impedance for testing on a set board, please be sure to discharge for each process since IC may be stressed. As a countermeasure against static electricity, prepare grounding in the assembly process and take sufficient care in transportation and storage. In addition, when connecting a capacitor to a jig in a testing process, please do so after turning the power OFF and remove it after turning the power OFF.

● Selection of order type



**SSON004X1216**

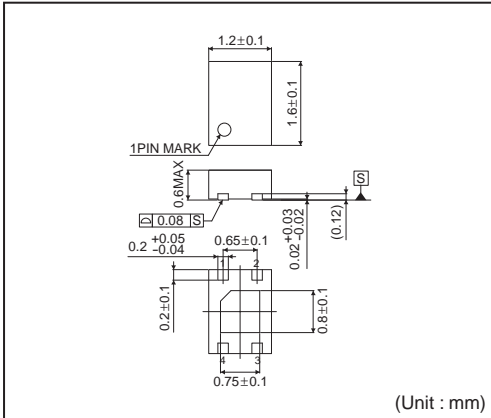

<Tape and Reel information>

Tape	Embossed carrier tape
Quantity	5000pcs
Direction of feed	TR (The direction is the 1pin of product is at the upper right when you hold reel on the left hand and you pull out the tape on the right hand)

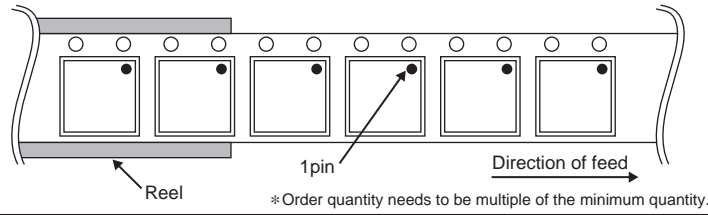

**HVSOF5**

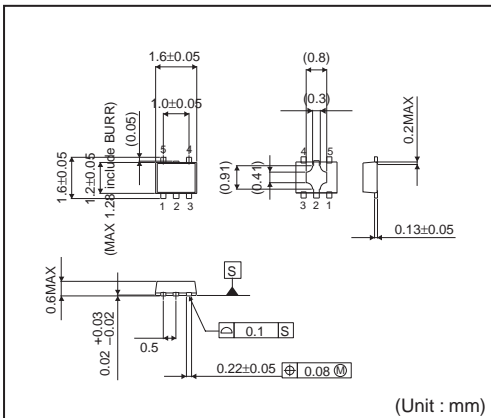

<Tape and Reel information>

Tape	Embossed carrier tape
Quantity	3000pcs
Direction of feed	TR (The direction is the 1pin of product is at the upper right when you hold reel on the left hand and you pull out the tape on the right hand)

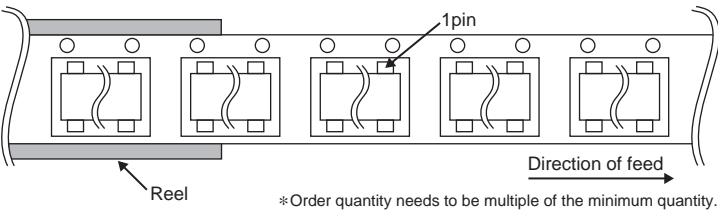

## Notes

No copying or reproduction of this document, in part or in whole, is permitted without the consent of ROHM Co.,Ltd.

The content specified herein is subject to change for improvement without notice.

The content specified herein is for the purpose of introducing ROHM's products (hereinafter "Products"). If you wish to use any such Product, please be sure to refer to the specifications, which can be obtained from ROHM upon request.

Examples of application circuits, circuit constants and any other information contained herein illustrate the standard usage and operations of the Products. The peripheral conditions must be taken into account when designing circuits for mass production.

Great care was taken in ensuring the accuracy of the information specified in this document. However, should you incur any damage arising from any inaccuracy or misprint of such information, ROHM shall bear no responsibility for such damage.

The technical information specified herein is intended only to show the typical functions of and examples of application circuits for the Products. ROHM does not grant you, explicitly or implicitly, any license to use or exercise intellectual property or other rights held by ROHM and other parties. ROHM shall bear no responsibility whatsoever for any dispute arising from the use of such technical information.

The Products specified in this document are intended to be used with general-use electronic equipment or devices (such as audio visual equipment, office-automation equipment, communication devices, electronic appliances and amusement devices).

The Products specified in this document are not designed to be radiation tolerant.

While ROHM always makes efforts to enhance the quality and reliability of its Products, a Product may fail or malfunction for a variety of reasons.

Please be sure to implement in your equipment using the Products safety measures to guard against the possibility of physical injury, fire or any other damage caused in the event of the failure of any Product, such as derating, redundancy, fire control and fail-safe designs. ROHM shall bear no responsibility whatsoever for your use of any Product outside of the prescribed scope or not in accordance with the instruction manual.

The Products are not designed or manufactured to be used with any equipment, device or system which requires an extremely high level of reliability the failure or malfunction of which may result in a direct threat to human life or create a risk of human injury (such as a medical instrument, transportation equipment, aerospace machinery, nuclear-reactor controller, fuel-controller or other safety device). ROHM shall bear no responsibility in any way for use of any of the Products for the above special purposes. If a Product is intended to be used for any such special purpose, please contact a ROHM sales representative before purchasing.

If you intend to export or ship overseas any Product or technology specified herein that may be controlled under the Foreign Exchange and the Foreign Trade Law, you will be required to obtain a license or permit under the Law.



Thank you for your accessing to ROHM product informations.  
More detail product informations and catalogs are available, please contact us.

## ROHM Customer Support System

<http://www.rohm.com/contact/>

Компания «Океан Электроники» предлагает заключение долгосрочных отношений при поставках импортных электронных компонентов на взаимовыгодных условиях!

Наши преимущества:

- Поставка оригинальных импортных электронных компонентов напрямую с производств Америки, Европы и Азии, а так же с крупнейших складов мира;
- Широкая линейка поставок активных и пассивных импортных электронных компонентов (более 30 млн. наименований);
- Поставка сложных, дефицитных, либо снятых с производства позиций;
- Оперативные сроки поставки под заказ (от 5 рабочих дней);
- Экспресс доставка в любую точку России;
- Помощь Конструкторского Отдела и консультации квалифицированных инженеров;
- Техническая поддержка проекта, помощь в подборе аналогов, поставка прототипов;
- Поставка электронных компонентов под контролем ВП;
- Система менеджмента качества сертифицирована по Международному стандарту ISO 9001;
- При необходимости вся продукция военного и аэрокосмического назначения проходит испытания и сертификацию в лаборатории (по согласованию с заказчиком);
- Поставка специализированных компонентов военного и аэрокосмического уровня качества (Xilinx, Altera, Analog Devices, Intersil, Interpoint, Microsemi, Actel, Aeroflex, Peregrine, VPT, Syfer, Eurofarad, Texas Instruments, MS Kennedy, Miteq, Cobham, E2V, MA-COM, Hittite, Mini-Circuits, General Dynamics и др.);

Компания «Океан Электроники» является официальным дистрибьютором и эксклюзивным представителем в России одного из крупнейших производителей разъемов военного и аэрокосмического назначения «JONHON», а так же официальным дистрибьютором и эксклюзивным представителем в России производителя высокотехнологичных и надежных решений для передачи СВЧ сигналов «FORSTAR».



## JONHON

«JONHON» (основан в 1970 г.)

Разъемы специального, военного и аэрокосмического назначения:

(Применяются в военной, авиационной, аэрокосмической, морской, железнодорожной, горно- и нефтедобывающей отраслях промышленности)

«FORSTAR» (основан в 1998 г.)

ВЧ соединители, коаксиальные кабели, кабельные сборки и микроволновые компоненты:

(Применяются в телекоммуникациях гражданского и специального назначения, в средствах связи, РЛС, а так же военной, авиационной и аэрокосмической отраслях промышленности).



Телефон: 8 (812) 309-75-97 (многоканальный)

Факс: 8 (812) 320-03-32

Электронная почта: [ocean@oceanchips.ru](mailto:ocean@oceanchips.ru)

Web: <http://oceanchips.ru/>

Адрес: 198099, г. Санкт-Петербург, ул. Калинина, д. 2, корп. 4, лит. А