

Sensitive Snap-Action Pushbutton Switches — Solder and P.C. Terminals (Momentary Action)

PS SERIES 5 AMP. (S.P.)
1 AMP. (D.P.)
0.4 VA

DIRECT PANEL MOUNT

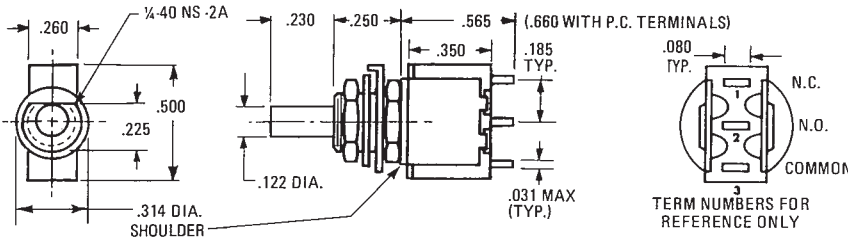

ONE POLE

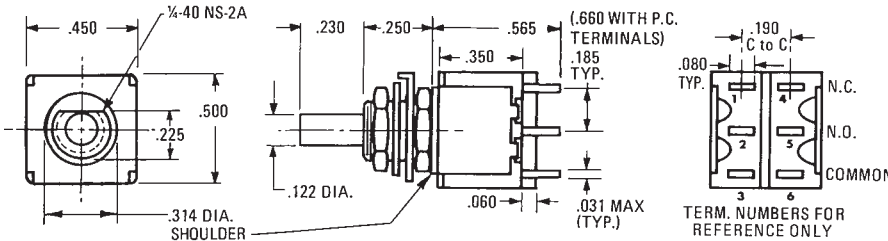

TWO POLE

Basic P/N	Terminal Type	Poles	Cap Size	Cap Color	Contact Material-Type
PS	1 - Solder lug 2 - Printed Circuit Terminals	1 - One ① 2 - Two ①	0 - No Cap 1 - .200 Dia. 2 - .375 Dia. 3 - .450 Sq. 4 - .310 Dia. 5 - .780 Sq. ③	0 - No Cap 1 - Black 2 - White 3 - Ted	B - Gold/Nickel/Brass ② G - Gold/Nickel/Silver ① ② Q - Coin Silver ①

- ① Single pole circuit rated 5 amps, double pole circuit rated 1 amp.
- ② Ratings are 0.4 VA — 28 BAC or DC
- ③ Supplied with .90" square black bezel as Standard

EXAMPLES:

PS1-100Q = One-pole, S.L., 5 amp., No Cap, Coin Silver Contacts

PS2-221B = Two-pole, PC, .4 VA, .375 Dia., Black Cap., Gold/Nickel/Brass Contacts

NEW .780" SQUARE CAP AND BEZEL

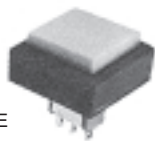

W-NU-29A

DECORATIVE FACE NUTS (SEE NOTE UNDER MATERIALS)

W-NU-30A

SPECIFICATIONS

Contact Rating — Letter codes G and Q (1 Pole) 5 amp resistive @ 125 VAC (U.L. recognized, CSA certified) or 5 amp resistive @ 28 VDC. (2 pole) 1 amp resistive @ 125 VAC (U.L. recognized, CSA certified) or 1 amp resistive @ 28 VDC.
Letter codes B and G — (1 and 2 Poles) 0.4 Volt-amps (VA) maximum @ 28 V max. (AC or DC).
Contact Resistance — 50 milliohms maximum.
Insulation Resistance — 1,000 megohms minimum.
Dielectric Strength — 1,000 volts RMS minimum at sea level.
Electrical Life — 60,000 cycles minimum at full load-resistive.
Maximum Allowable Installation Force on Plunger — 10 pounds.
 Multi-pole contacts do not make and break simultaneously.

MATERIALS

Case — Diallyl Phthalate.
Bushing — Brass, nickel plated.
Housing — Stainless steel.
Plunger — Thermoplastic.
Common Contact — Refer to contact material table above.
Center & End Contact — Refer to contact material table above.
Hardware — (2) Hex nuts W-NU-11, brass nickel plated. (1) Internal tooth lockwasher W-WA-16, steel chromium plated. (1) Locking Ring W-RI-16, C.R.S. nickel plated.
Decorative Face Nuts — Brass, bright chrome plated. See Page 16 for complete dimensions.

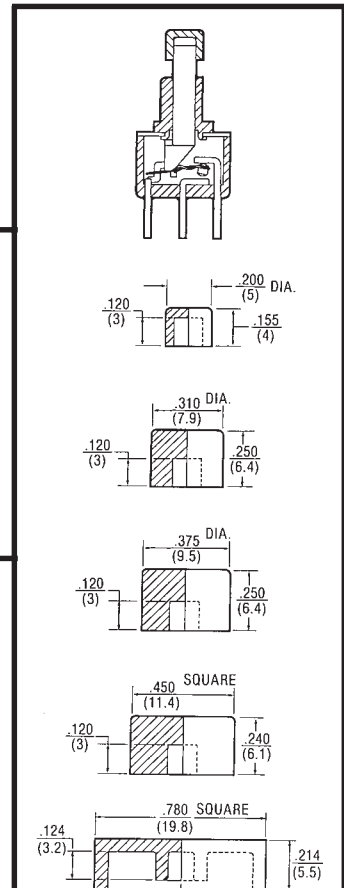

Description	P/N	Color
Small Cap .200	W-KN-16	Black
	W-KN-16A	White
	W-KN-16B	Red
Medium Cap .310	W-KN-32	Black
	W-KN-32A	White
Large Cap .375	W-KN-17	Black
	W-KN-17A	White
Square Cap .450	W-KN-18	Black
	W-KN-18A	White
.780 Square Cap	W-KN-18B	Red
	W-KN-52	Black
.90 Square Bezel	W-KN-52A	White
	W-KN-52B	Red
	Bezel W-BZ-21	Black

Solder Lug Terminal

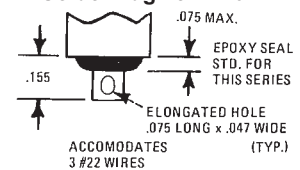

Printed Circuit Terminal

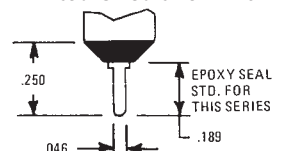

PS
SERIES 5 AMP. (S.P.)
0.4VA

**Sensitive Snap-Action Pushbutton Switches —
P.C. Terminals (Momentary Action)**

RIGHT ANGLE MOUNT IN P.C. BOARDS (HORIZONTAL)

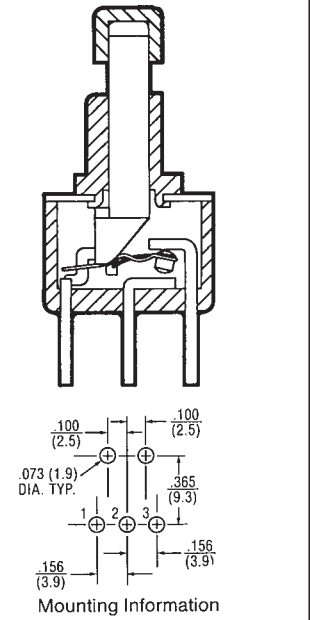
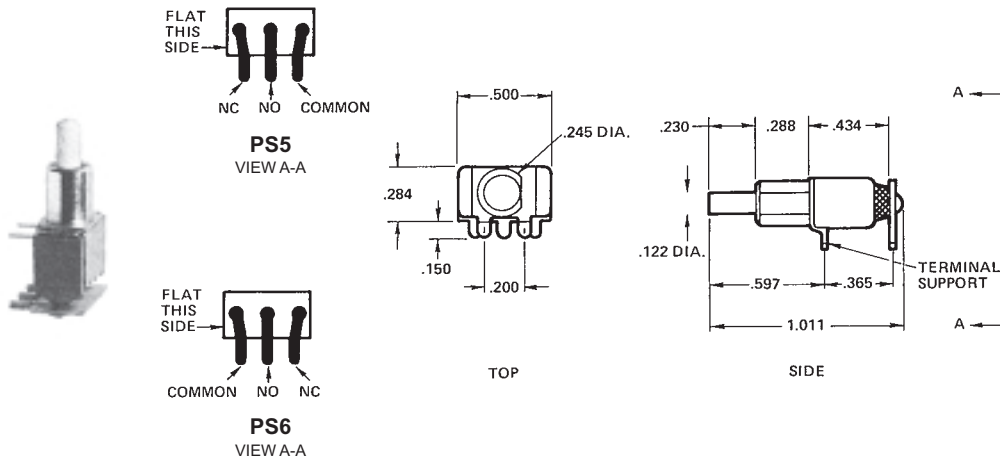

Basic P/N	Terminal Type	Poles	Cap Size	Cap Color	Contact Material-Type
PS	5 - Rt. Angle P.C. Mount 6 - Rt. Angle P.C. Mount	1 - One	0 - No Cap 1 - .200 Dia. 2 - .375 Dia. 3 - .450 Sq. 4 - .310 Dia.	0 - No Cap 1 - Black 2 - White 3 - Red	B - Gold/Nickel/Brass ② G - Gold/Nickel/Silver ①② Q - Coin Silver ②

- ① Rating is 5 amps — 125 VAC or 28 VDC.
- ② Ratings are 0.4 VA — 28 VAC or DC.

ORDERING EXAMPLES:

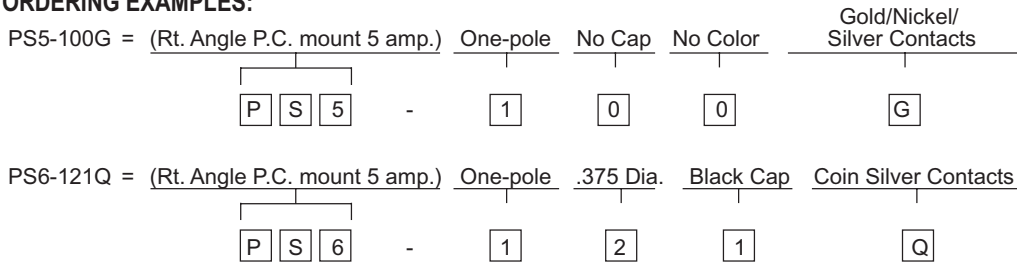

SPECIFICATIONS

Contact Rating — Letter codes G and Q — 5 amp resistive @ 125 VAC or 28 VDC.
Letter codes B and G — 0.4 volts-amps (VA) maximum @ 28 VAC or DC.

Contact Resistance — 50 milliohms maximum.

Insulation Resistance — 1,000 megohms minimum.

Dielectric Strength — 1,000 volts RMS minimum at sea level.

Electrical Life — 60,000 cycles minimum at full load.

Maximum Allowable Installation Force on Plunger — 10 pounds.

MATERIALS

Case — Diallyl Phthalate.

Bushing — Brass, nickel plated.

Housing — Stainless steel.

Plunger — Thermoplastic.

Common Contact — Refer to contact material table above.

Center & End Contact — Refer to contact material table above.

Description	P/N	Color
Small Cap .200	W-KN-16	Black
	W-KN-16A	White
	W-KN-16B	Red
Medium Cap .310	W-KN-32	Black
	W-KN-32A	White
	W-KN-32B	Red
Large Cap .375	W-KN-17	Black
	W-KN-17A	White
	W-KN-17B	Red
Square Cap .450	W-KN-18	Black
	W-KN-18A	White
	W-KN-18B	Red

Sensitive Snap-Action Pushbutton Switches — P.C. Terminals (Momentary Action)

PS SERIES	5 AMP. (S.P.)
	1 AMP. (D.P.)
	0.4 VA

RIGHT ANGLE P.C. MOUNT SWITCHES

Basic P/N	Terminal Type	Poles	Cap Size	Cap Color	Contact Material-Type
PS	9 - Horizontal Right Angle	1 - One ①	0 - No Cap	0 - No Cap	B - Gold/Nickel/Brass ②
	10 - Vertical Right Angle (.100 Terminal Spacing)		1 - .200 Dia.	1 - Black	G - Gold/Nickel/Silver ① ②
	11 - Vertical Right Angle 0.4 VA (.150 Terminal Spacing)		2 - .375 Dia.	2 - White	Q - Coin Silver ①
		2 - Two ①	3 - .450 Sq.	3 - Red	
			4 - .310 Dia.		

- ① Single pole circuit rated 5 amps, double pole circuit rated 1 amp.
- ② Ratings are 0.4 VA — 28 VAC or DC.

ORDERING EXAMPLES:

PS9-100B =	(PC mounted 0.4 VA)	One-pole	No Cap	No Color	Gold/Nickel/ Brass Contacts								
	<table border="1" style="margin: auto;"> <tr><td>P</td><td>S</td><td>9</td></tr> </table>	P	S	9	-	<table border="1" style="margin: auto;"> <tr><td>1</td></tr> </table>	1	<table border="1" style="margin: auto;"> <tr><td>0</td></tr> </table>	0	<table border="1" style="margin: auto;"> <tr><td>0</td></tr> </table>	0	<table border="1" style="margin: auto;"> <tr><td>B</td></tr> </table>	B
P	S	9											
1													
0													
0													
B													
PS10-221Q=	(PC mounted 1 amp.)	Two-pole	.375 Dia.	Black Cap	Coin Silver Contacts								
	<table border="1" style="margin: auto;"> <tr><td>P</td><td>S</td><td>10</td></tr> </table>	P	S	10	-	<table border="1" style="margin: auto;"> <tr><td>2</td></tr> </table>	2	<table border="1" style="margin: auto;"> <tr><td>2</td></tr> </table>	2	<table border="1" style="margin: auto;"> <tr><td>1</td></tr> </table>	1	<table border="1" style="margin: auto;"> <tr><td>Q</td></tr> </table>	Q
P	S	10											
2													
2													
1													
Q													

SPECIFICATIONS

Contact Rating — Letter codes G and Q (1 Pole) 5 amp resistive @ 125 VAC (U.L. recognized, CSA certified) or 5 amp resistive @ 28 VDC. (2 pole) 1 amp resistive @ 125 VAC (U.L. recognized, CSA certified) or 1 amp resistive @ 28 VDC.

Letter codes B and G — (1 and 2 Poles) 0.4 Volt-amps (VA) maximum @ 28 V maximum (AC or DC).

Contact Resistance — 50 milliohms maximum.

Insulation Resistance — 1,000 megohms minimum.

Dielectric Strength — 1,000 volts RMS minimum at sea level.

Electrical Life — 60,000 cycles minimum at full load-resistive.

Maximum Allowable Installation Force on Plunger — 10 pounds.

Multi-pole contacts do not make and break simultaneously.

MATERIALS

Case — Diallyl Phthalate.

Bushing — Brass, nickel plated.

Housing — Stainless steel.

Plunger — Thermoplastic.

Common Contact — Refer to contact material table above.

Center & End Contact — Refer to contact material table above.

Description	P/N	Color
Small Cap .200	W-KN-16	Black
	W-KN-16A	White
	W-KN-16B	Red
Medium Cap .310	W-KN-32	Black
	W-KN-32A	White
Large Cap .375	W-KN-17	Black
	W-KN-17A	White
	W-KN-17B	Red
Square Cap .450	W-KN-18	Black
	W-KN-18A	White
	W-KN-18B	Red

Right Angle P.C. Terminal

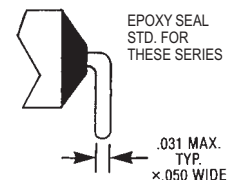

**Sensitive Snap-Action Pushbutton Switches —
P.C. Terminals (Momentary Action)**

PS SERIES 5 AMP. (S.P.)
1 AMP. (D.P.)
0.4VA

RIGHT ANGLE P.C. MOUNT SWITCHES

PS 9

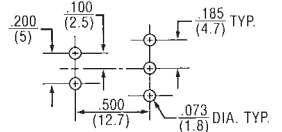
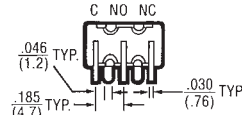
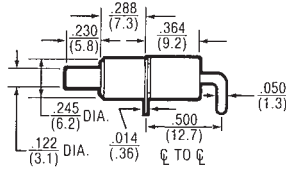
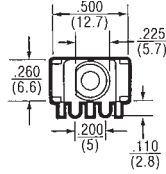

1 Pole P.C. Mounting

ONE POLE

EPOXY SEALED P.C. TERMINALS ARE SUPPLIED AS STANDARD FOR THESE OPTIONS.

PS 9

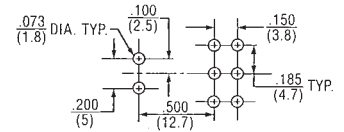
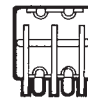
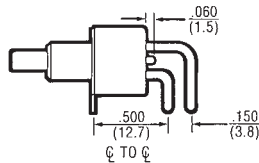
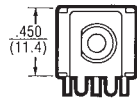

2 Pole P.C. Mounting

TWO POLE

EPOXY SEALED P.C. TERMINALS ARE SUPPLIED AS STANDARD FOR THESE OPTIONS.

PS 10

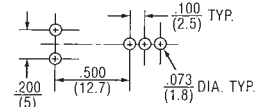
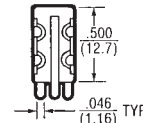
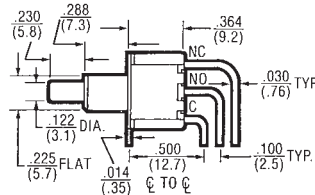
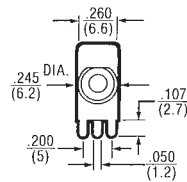

1 Pole P.C. Mounting

ONE POLE

EPOXY SEALED P.C. TERMINALS ARE SUPPLIED AS STANDARD FOR THESE OPTIONS.

PS 10

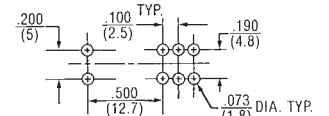
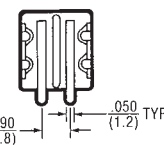
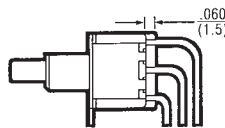
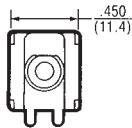

2 Pole P.C. Mounting

TWO POLE

EPOXY SEALED P.C. TERMINALS ARE SUPPLIED AS STANDARD FOR THESE OPTIONS.

PS 11

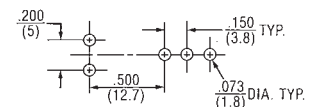
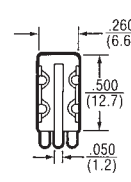
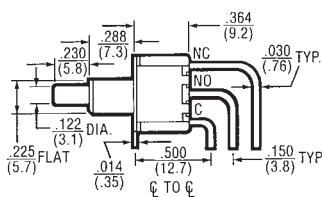
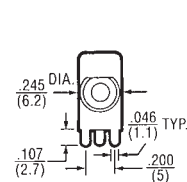

1 Pole P.C. Mounting

ONE POLE

EPOXY SEALED P.C. TERMINALS ARE SUPPLIED AS STANDARD FOR THESE OPTIONS.

PS 11

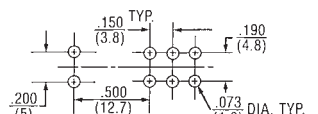
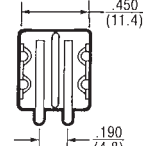
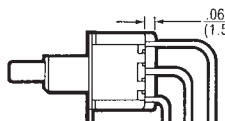

2 Pole P.C. Mounting

TWO POLE

EPOXY SEALED P.C. TERMINALS ARE SUPPLIED AS STANDARD FOR THESE OPTIONS.

Sensitive Snap-Action Pushbutton Switches — P.C. Terminals (Momentary Action)

PS SERIES 5 AMP. (S.P.)
1 AMP. (D.P.)
0.4 VA

VERTICAL P.C. MOUNT (.460 x .620 BRACKET)

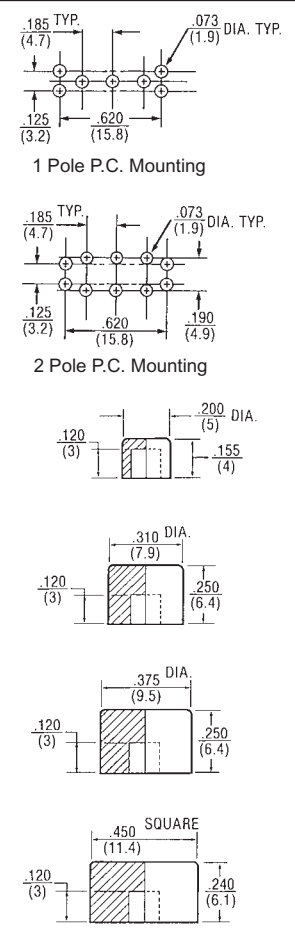
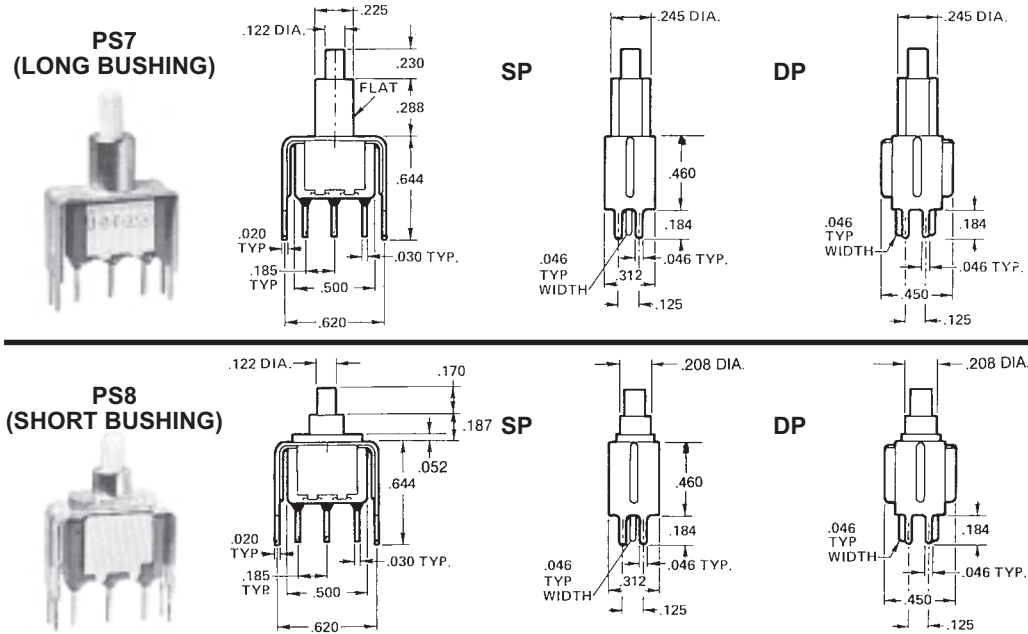

Basic P/N	Terminal Type	Poles	Cap Size	Cap Color	Contact Material-Type
PS	7 - PC Mounted 8 - PC Mounted	1 - One ① 2 - Two ①	0 - No Cap 1 - .200 Dia. 2 - .375 Dia. 3 - .450 Sq. 4 - .310 Dia.	0 - No Cap 1 - Black 2 - White	B - Gold/Nickel/Brass ② G - Gold/Nickel/Silver ① ② Q - Coin Silver ①

① Single pole circuit rated 5 amps, double pole circuit rated 1 amp.
② Ratings are 0.4 VA — 28 VAC or DC.

ORDERING EXAMPLES:

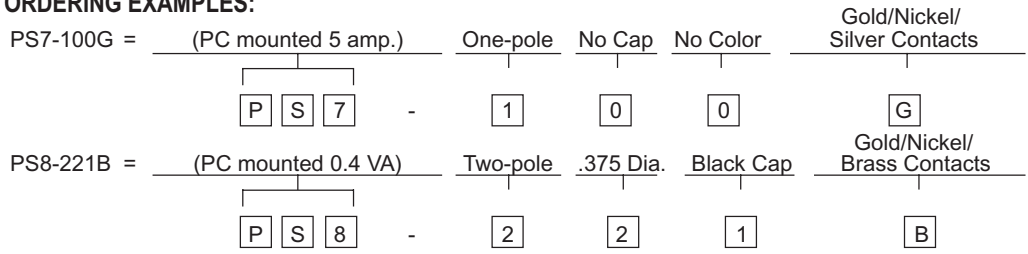

SPECIFICATIONS

Contact Rating — Letter codes G and Q (1 Pole) 5 amp resistive @ 125 VAC (U.L. recognized, CSA certified) or 5 amp resistive @ 28 VDC. (2 pole) 1 amp resistive @ 125 VAC (U.L. recognized, CSA certified) or 1 amp resistive @ 28 VDC.
 Letter codes B and G — (1 and 2 Poles) 0.4 Volt-amps (VA) maximum @ 28 V maximum (AC or DC).
Contact Resistance — 50 milliohms maximum.
Insulation Resistance — 1,000 megohms minimum.
Dielectric Strength — 1,000 volts RMS minimum at sea level.
Electrical Life — 60,000 cycles minimum at full load-resistive.
Maximum Allowable Installation Force on Plunger — 10 pounds.
 Multi-pole contacts do not make and break simultaneously.

MATERIALS

Case — Diallyl Phthalate.
Bushing — Brass, nickel plated.
Housing — Stainless steel.
Plunger — Thermoplastic.
Common Contact — Refer to contact material table above.
Center & End Contact — Refer to contact material table above.

Description	P/N	Color
Small Cap .200	W-KN-16	Black
	W-KN-16A	White
	W-KN-16B	Red
Medium Cap .310	W-KN-32	Black
	W-KN-32A	White
	W-KN-32B	Red
Large Cap .375	W-KN-17	Black
	W-KN-17A	White
	W-KN-17B	Red
Square Cap .450	W-KN-18	Black
	W-KN-18A	White
	W-KN-18B	Red

Printed Circuit Terminal



Sensitive Snap-Action Pushbutton Switches — P.C. Terminals (Momentary Action)

PS SERIES 5 AMP. (S.P.)
1 AMP. (D.P.)
0.4 VA

VERTICAL P.C. MOUNT (.630 x .620 BRACKET)

PS71 (LONG BUSHING)

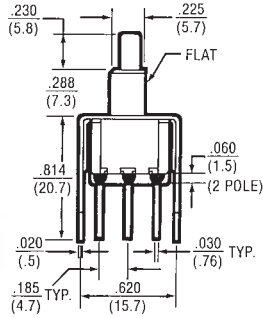

SP

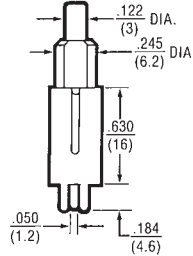

DP

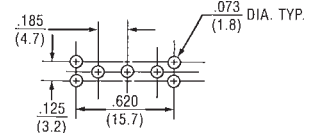
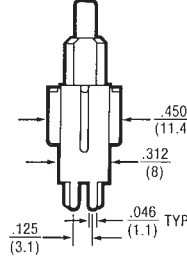

1 Pole P.C. Mounting

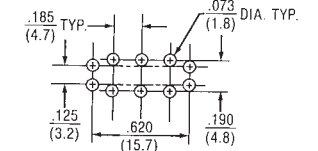

2 Pole P.C. Mounting

PS81 (SHORT BUSHING)

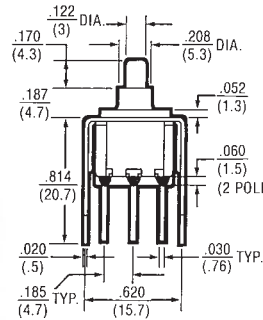
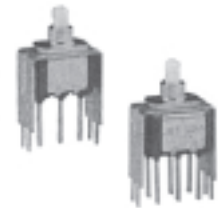

SP

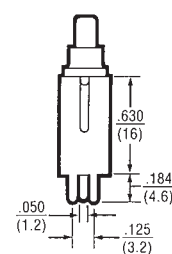

DP

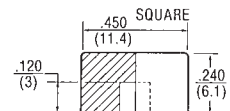
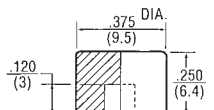
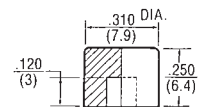
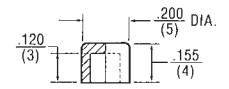
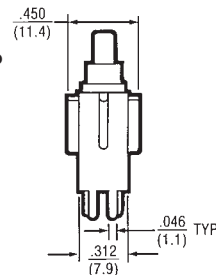

Basic P/N	Terminal Type	Poles	Cap Size	Cap Color	Contact Material-Type
PS	71 - PC Mounted	1 - One ①	0 - No Cap	0 - No Cap	B - Gold/Nickel/Brass ②
	81 - PC Mounted	2 - Two ①	1 - .200 Dia. 2 - .375 Dia. 3 - .450 Sq. 4 - .310 Dia.	1 - Black 2 - White 3 - Red	G - Gold/Nickel/Silver ① ② Q - Coin Silver ①

- ① Single pole circuit rated 5 amps, double pole circuit rated 1 amp.
- ② Ratings are 0.4 VA — 28 VAC or DC.

ORDERING EXAMPLES:

PS71-100B= (PC mounted 0.4 VA) One-pole No Cap No Color Gold/Nickel/Brass Contacts

P
S
71
-
1
-
0
-
0
-
B

PS81-221Q= (PC mounted 1 amp.) Two-pole .375 Dia. Black Cap Coin Silver Contacts

P
S
81
-
2
-
2
-
1
-
Q

SPECIFICATIONS

Contact Rating — Letter codes G and Q (1 Pole) 5 amp resistive @ 125 VAC (U.L. recognized, CSA certified) or 5 amp resistive @ 28 VDC. (2 pole) 1 amp resistive @ 125 VAC (U.L. recognized, CSA certified) or 1 amp resistive @ 28 VDC.

Letter codes B and G — (1 and 2 Poles) 0.4 Volt-amps (VA) maximum @ 28 V maximum (AC or DC).

Contact Resistance — 50 milliohms maximum.

Insulation Resistance — 1,000 megohms minimum.

Dielectric Strength — 1,000 volts RMS minimum at sea level.

Electrical Life — 60,000 cycles minimum at full load-resistive.

Maximum Allowable Installation Force on Plunger — 10 pounds.

Multi-pole contacts do not make and break simultaneously.

MATERIALS

Case — Diallyl Phthalate.

Bushing — Brass, nickel plated.

Housing — Stainless steel.

Plunger — Thermoplastic.

Common Contact — Refer to contact material table above.

Center & End Contact — Refer to contact material table above.

Description	P/N	Color
Small Cap .200	W-KN-16	Black
	W-KN-16A	White
	W-KN-16B	Red
Medium Cap .310	W-KN-32	Black
	W-KN-32A	White
	W-KN-32B	Red
Large Cap .375	W-KN-17	Black
	W-KN-17A	White
	W-KN-17B	Red
Square Cap .450	W-KN-18	Black
	W-KN-18A	White
	W-KN-18B	Red

Printed Circuit Terminal



Sensitive Snap-Action Pushbutton Switches — P.C. Terminals (Momentary Action)

PS SERIES 5 AMP. (S.P.)
1 AMP. (D.P.)
0.4 VA

VERTICAL P.C. MOUNT (.460 x .750 BRACKET)

PS72 (LONG BUSHING)

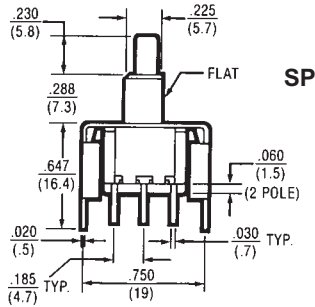

SP

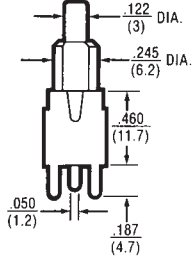

DP

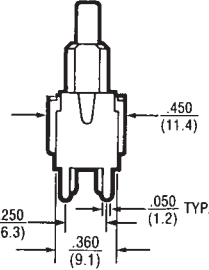

PS82 (SHORT BUSHING)

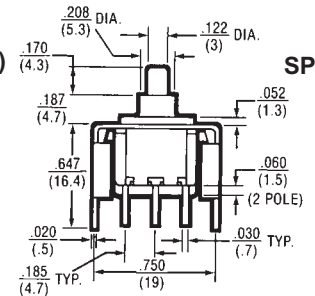

SP

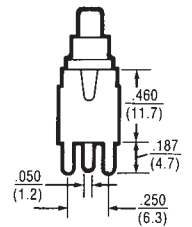

DP

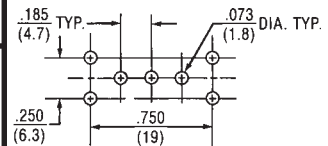
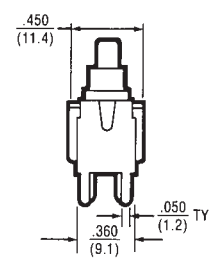

1 Pole P.C. Mounting

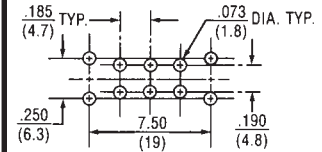

2 Pole P.C. Mounting

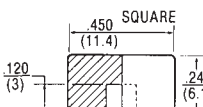
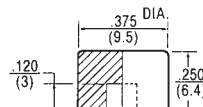
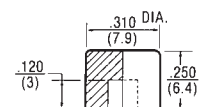
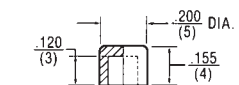

Basic P/N	Terminal Type	Poles	Cap Size	Cap Color	Contact Material-Type
PS	72 - PC Mounted 82 - PC Mounted	1 - One ① 2 - Two ①	0 - No Cap 1 - .200 Dia. 2 - .375 Dia. 3 - .450 Sq. 4 - .310 Dia.	0 - No Cap 1 - Black 2 - White 3 - Red	B - Gold/Nickel/Brass ② G - Gold/Nickel/Silver ① ② Q - Coin Silver ①

① Single pole circuit rated 5 amps, double pole circuit rated 1 amp.
② Ratings are 0.4 VA — 28 VAC or DC.

ORDERING EXAMPLES:

PS72-100Q= (PC mounted 5 amp.) One-pole No Cap No Color Coin Silver Contacts



PS82-221B= (PC mounted 0.4 VA) Two-pole .375 Dia. Black Cap Gold/Nickel/Brass Contacts



SPECIFICATIONS

Contact Rating — Letter codes G and Q (1 Pole) 5 amp resistive @ 125 VAC (U.L. recognized, CSA certified) or 5 amp resistive @ 28 VDC. (2 pole) 1 amp resistive @ 125 VAC (U.L. recognized, CSA certified) or 1 amp resistive @ 28 VDC.
Letter codes B and G — (1 and 2 Poles) 0.4 Volt-amps (VA) maximum @ 28 V maximum (AC or DC).
Contact Resistance — 50 milliohms maximum.
Insulation Resistance — 1,000 megohms minimum.
Dielectric Strength — 1,000 volts RMS minimum at sea level.
Electrical Life — 60,000 cycles minimum at full load-resistive.
Maximum Allowable Installation Force on Plunger — 10 pounds.
Multi-pole contacts do not make and break simultaneously.

MATERIALS

Case — Diallyl Phthalate.
Bushing — Brass, nickel plated.
Housing — Stainless steel.
Plunger — Thermoplastic.
Common Contact — Refer to contact material table above.
Center & End Contact — Refer to contact material table above.

Description	P/N	Color
Small Cap .200	W-KN-16	Black
	W-KN-16A	White
	W-KN-16B	Red
Medium Cap .310	W-KN-32	Black
	W-KN-32A	White
	W-KN-32B	Red
Large Cap .375	W-KN-17	Black
	W-KN-17A	White
	W-KN-17B	Red
Square Cap .450	W-KN-18	Black
	W-KN-18A	White
	W-KN-18B	Red

Printed Circuit Terminal



Sensitive Snap-Action Pushbutton Switches — P.C. Terminals (Momentary Action)

PS SERIES 5 AMP. (S.P.)
1 AMP (D.P.)
0.4 VA

VERTICAL P.C. MOUNT (.630 x .750 BRACKET)

PS73 (LONG BUSHING)

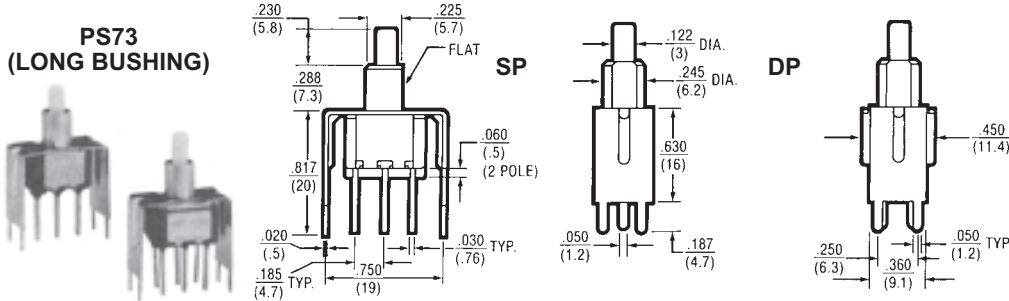

PS83 (SHORT BUSHING)

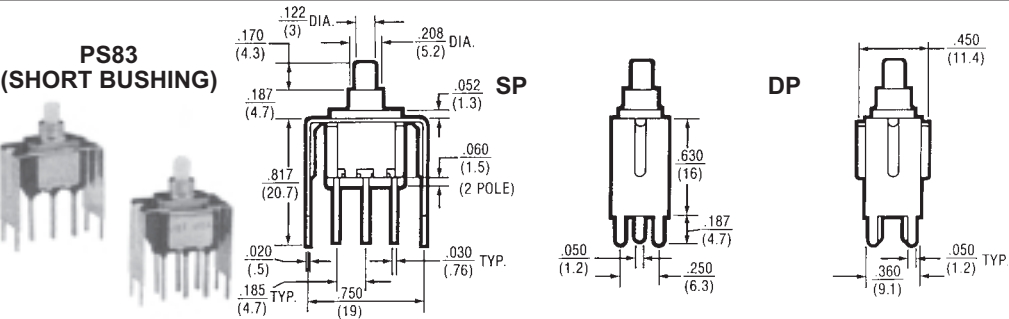

Basic P/N	Terminal Type	Poles	Cap Size	Cap Color	Contact Material-Type
PS	73 - PC Mounted	1 - One	0 - No Cap	0 - No Cap	B - Gold/Nickel/Brass ②
	83 - PC Mounted	2 - Two	1 - .200 Dia.	1 - Black	G - Gold/Nickel/Silver ①②
			2 - .375 Dia.	2 - White	Q - Coin Silver ②
			3 - .450 Sq.	3 - Red	

- ① Single pole circuit rated 5 amps, double pole circuit rated 1 amp.
- ② Ratings are 0.4 VA — 28 VAC or DC.

ORDERING EXAMPLES:

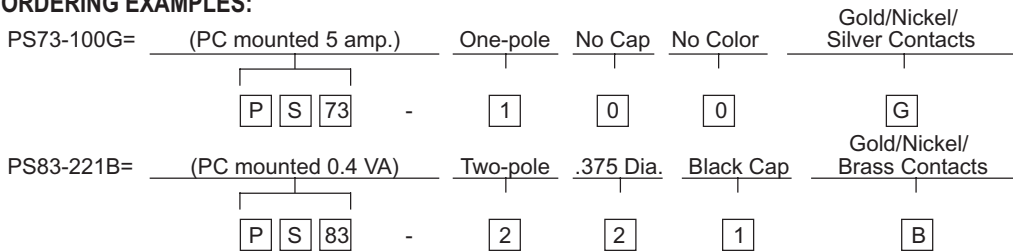

SPECIFICATIONS

Contact Rating — Letter codes G and Q (1 Pole) 5 amp resistive @ 125 VAC (U.L. recognized, CSA certified) or 5 amp resistive @ 28 VDC. (2 pole) 1 amp resistive @ 125 VAC (U.L. recognized, CSA certified) or 1 amp resistive @ 28 VDC.

Letter codes B and G — (1 and 2 Poles) 0.4 Volt-amps (VA) maximum @ 28 V maximum (AC or DC).

Contact Resistance — 50 milliohms maximum.

Insulation Resistance — 1,000 megohms minimum.

Dielectric Strength — 1,000 volts RMS minimum at sea level.

Electrical Life — 60,000 cycles minimum at full load-resistive.

Maximum Allowable Installation Force on Plunger — 10 pounds.

Multi-pole contacts do not make and break simultaneously.

MATERIALS

Case — Diallyl Phthalate.
Bushing — Brass, nickel plated.
Housing — Stainless steel.
Plunger — Thermoplastic.
Common Contact — Refer to contact material table above.
Center & End Contact — Refer to contact material table above.

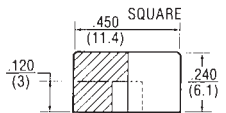
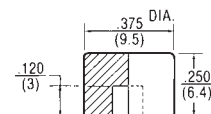
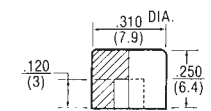
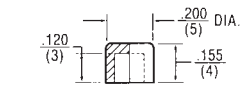
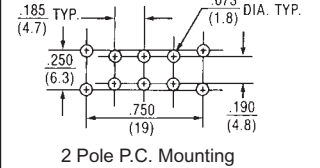
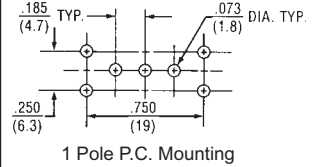

Description	P/N	Color
Small Cap .200	W-KN-16	Black
	W-KN-16A	White
	W-KN-16B	Red
Medium Cap .310	W-KN-32	Black
	W-KN-32A	White
	W-KN-32B	Red
Large Cap .375	W-KN-17	Black
	W-KN-17A	White
	W-KN-17B	Red
Square Cap .450	W-KN-18	Black
	W-KN-18A	White
	W-KN-18B	Red

Printed Circuit Terminal



Sensitive Snap-Action Pushbutton Switches — Solder and P.C. Terminals (Momentary Action)

PS SERIES 5 AMP. (S.P.)
1 AMP. (D.P.)
0.4 VA

SNAP-IN MOUNT

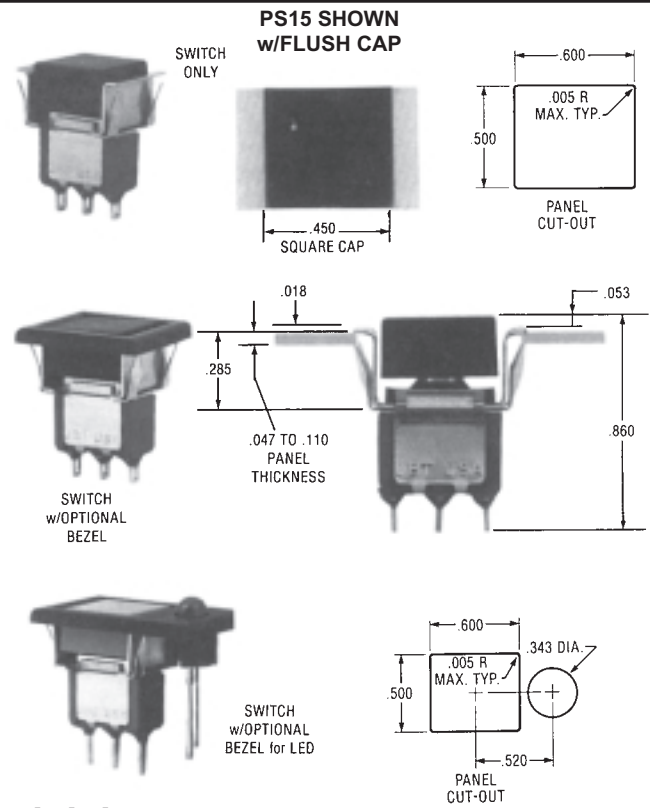
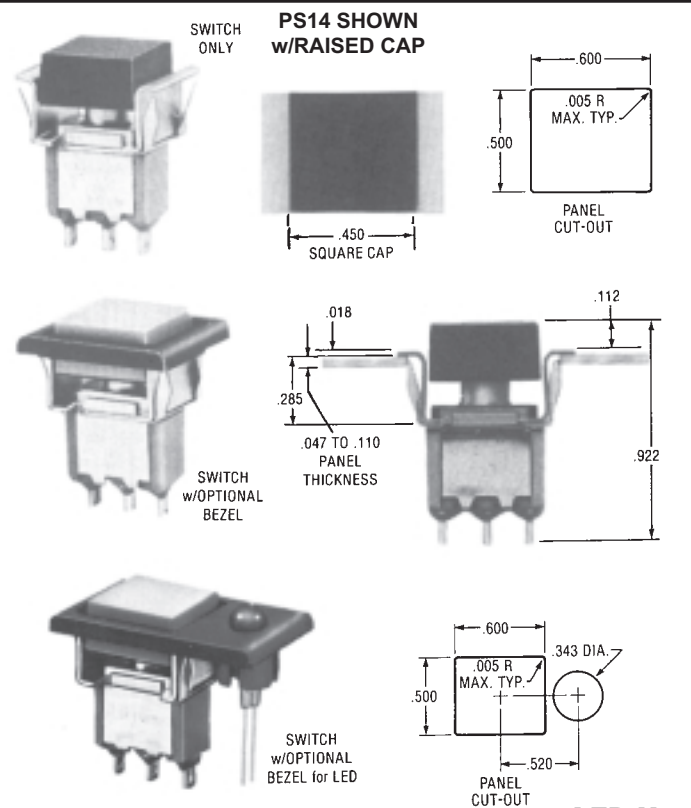

LED Not Included

Basic P/N	Cap Configuration Terminal-Rating	Poles	Cap Size	Cap Color	Optional Features	
					Bezel Color & Type	Contact Material-Type
PS	14 - Raised Cap Solder Lug	1 - One ① 2 - Two ①	0 - No Cap 1 - .450 Sq.	0 - No Cap 1 - White 2 - Black 3 - Red	1 - White 2 - Black 3 - Red 4 - Black or LED	B - Gold/Nickel/Brass ②
	15 - Flush Cap ③ Solder Lug					G - Gold/Nickel/Silver ① ②
	16 - Raised Cap PC Terminals					Q - Coin Silver ①
	17 - Flush Cap ③ PC Terminals					

① Single pole circuit rated 5 amps, double pole circuit rated 1 amp.

② Ratings are 0.4 VA — 28 BAC or DC.

③ Flush cap is flush to bezel, not to mounting bracket.

EXAMPLES:

PS14-100Q = Raised Cap, Solder Lug Terminals, 5 Amp, Single Pole, No Cap, Coin Silver Contacts

PS14-1134B = Raised Cap, Solder Lug Terminals, 0.4 VA Rating, Single Pole, .450 Square Red Cap, Black Bezel for LED, Gold/Brass Contact Material

SPECIFICATIONS

Contact Rating — Letter codes G and Q (1 Pole) 5 amp resistive @ 125 VAC (U.L. recognized, CSA certified) or 5 amp resistive @ 28 VDC. (2 pole) 1 amp resistive @ 125 VAC (U.L. recognized, CSA certified) or 1 amp resistive @ 28 VDC.

Letter codes B and G — (1 and 2 Poles) 0.4 Volt-amps (VA) maximum @ 28 V maximum (AC or DC).

Contact Resistance — 50 milliohms maximum.

Insulation Resistance — 1,000 megohms minimum.

Dielectric Strength — 1,000 volts RMS minimum at sea level.

Electrical Life — 60,000 cycles minimum at full load-resistive.

Maximum Allowable Installation Force on Plunger — 10 pounds. Multi-pole contacts do not make and break simultaneously.

MATERIALS

Case — Diallyl Phthalate.

Bushing — Brass, nickel plated.

Housing — Stainless steel.

Plunger — Thermoplastic.

Pushbutton Cap — Molded nylon.

Bezel — Molded nylon.

Common Contact — Refer to contact material table above.

Center & End Contact — Refer to contact material table above.

Solder Lug Terminal

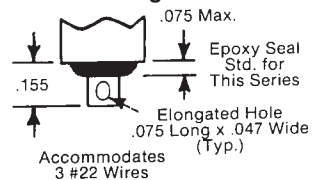

PC Terminal

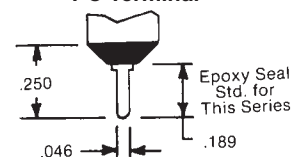

Sensitive Snap-Action Pushbutton Switches — Solder and P.C. Terminals (Momentary Action)

APPROXIMATE DIMENSIONS (For Optional Bezel Types Shown on Page 12)

OPTIONAL BEZEL TYPE 1, 2, 3 (SEE TABLE)
PS14 Shown w/Raised Cap

Catalog No.	Color
W-BZ-12	Black
W-BZ-12A	White
W-BZ-12B	Red

OPTIONAL BEZEL TYPE 1, 2, 3 (SEE TABLE)
PS15 Shown w/Flush Cap

Catalog No.	Color
W-BZ-12	Black
W-BZ-12A	White
W-BZ-12B	Red

OPTIONAL BEZEL TYPE 4 FOR LED
PS14 Shown w/Raised Cap

LED (.200 DIA.) SNAPS SECURELY INTO BEZEL. HEIGHT DEPENDS ON LED USED

SWITCHES SUPPLIED WITHOUT LED LAMPS.

Catalog No.	Color
W-BZ-15	Black

OPTIONAL BEZEL TYPE 4 FOR LED
PS17 Shown w/Flush Cap

LED (.200 DIA.) SNAPS SECURELY INTO BEZEL. HEIGHT DEPENDS ON LED USED

SWITCHES SUPPLIED WITHOUT LED LAMPS.

Catalog No.	Color
W-BZ-15	Black

OPTIONAL MOUNTING CLIP (For Use With PS14 Thru PS17 Series Only)

- For thick plastic panel mount applications (.094" - .125" thick)
- For availability consult Electroswitch.

Standard Ordering Table – Pushbutton Switches – Panelmount Maintained and Momentary Action (SPDT)

HOW TO ORDER YOUR DESIGN (Bold Face Type indicates items normally in Distributor Stock)

Following the table from left to right, the designer is able to specify the options wanted. The options are described and illustrated on pages 15-16.

To determine a part number select the options desired and fill in the boxes in the selection guides illustrated below.

Pushbutton Switch Selection Guide

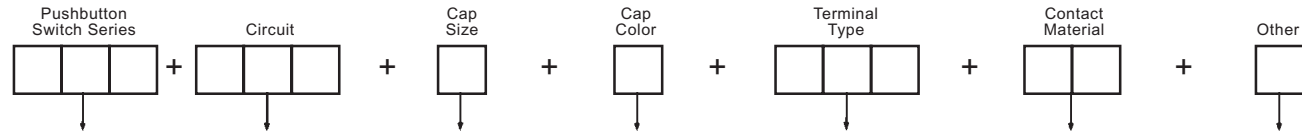

Base P/N	Circuit	Cap Size	Suffix Numbers & Letters — Add to Base Catalog Number			
			Cap Color	Terminal Options ②	Contact Material-Type	Other Options
PB	-123 — ON-NONE-ON Push to make contact and Push again to reverse action	0 — No Cap 1 — .200 Dia. 2 — .310 Dia. 3 — .375 Dia.	0 — No Cap 1 — Black 2 — White 3 — Red	Z — Solder Lugs C — Printed Circuit Z3 — Quick Connect W — .750" Wirewrap W1 — .964" Wirewrap W3 — .425" Wirewrap W4 — 1.0625" Wirewrap A — Right Angle P.C. AV — Vertical P.C. AV2 — Vertical P.C. .100 Spacing .150 Spacing	B — Gold/Nickel/Brass ① G — Gold/Nickel/Silver Q — Coin Silver K — Ⓢ L — Ⓢ M — Ⓢ	Epoxy Sealed Terminals ②
PBS Plunger Seal	-126 — ON-NONE-ON* Normally Open or Normally Closed. (For NC circuit use Terminal 2 & 1, for NO. 2 & 3, for NC and NO. 1, 2 & 3)					
PBW Plunger & Panel Seal						

*Momentary Contact

① Ratings are 0.4 VA-28 VAC or DC.

② Epoxy seal standard on all terminal options.

Ⓢ Same as B, G and Q respectively except terminals brass with tin nickel alloy over nickel plate. Consult factory for availability

EXAMPLES:

PB-12331ZQ = Maintained (Push-Push) circuit, .375" Black Cap, Solder Lug Terminals, Silver Contacts, 6 Amp Rating and Epoxy Sealed Terminals

PBW-12613CB = Plunger & Panel Seal, Momentary circuit, .200" Red Cap epoxy sealed Printed Circuit Terminals and 50 Millionths Gold over Brass contacts.

APPROXIMATE DIMENSIONS

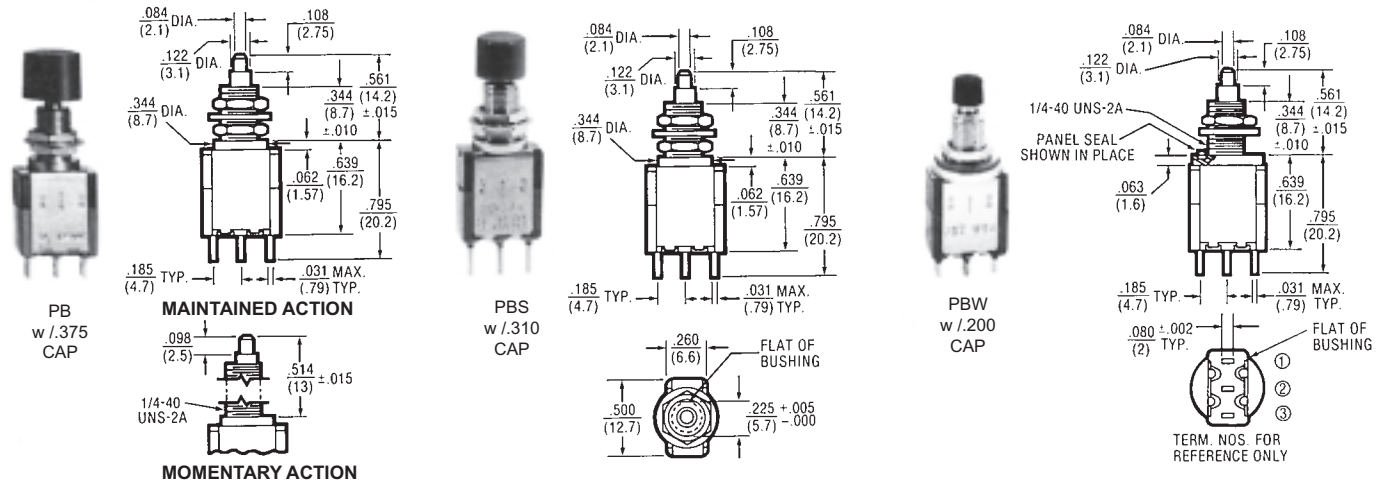

SPECIFICATIONS

Contact Rating — Letter codes G and Q — 6 amp at 125 VAC, 3 amp at 250 VAC (U.L. recognized, CSA certified) or 6 amp at 28 VDC resistive. Letter codes B and G — 0.5. volt-amp (VA) maximum @ 28 V maximum (AC or DC).

Life Under Load (Resistive)

Alternate Action Suffix — 123; 100,000 make-and break cycles
Momentary Action Suffix — 126; 60,000 make-and-break cycles

Initial Contact Resistance — 10 milliohms max. 3 VDC, 100 ma for both silver and gold plated contacts.

Insulation Resistance — 1,000 MBG.

Dielectric Strength — 1,000 volts rms at sea level.

Bushing Strength — 12 pound-inches without physical damage to switch.

	-126	-123
Operating Force	1.5 lb.	1.75 lb.
Pretravel	.043 Max.	.106 Max.
Overtravel	.009 Min.	.008 Min.

MATERIALS

Base (body) — Diallyl Phthalate.

Bushing — Brass, nickel plated.

Clamp (frame) — Stainless steel.

Switching Contacts and Rockers

Letter Code B — gold/nickel/brass

Letter Code G — gold/nickel/silver

Letter Code Q — Coin silver

Center Terminal

Letter Codes B, G — Gold flash/nickel/brass

Letter Code Q — Silver plated brass.

Hardware

PB and PBS Series

(2) W-NU-11 hex nuts

(1) W-WA-16 internal tooth lockwasher

PBW Series

(1) W-NU-11 hex nut

(1) W-WA-16 internal tooth lockwasher

(1) W-WA-44 neoprene panel seal

Pushbutton Switches — Panelmount Maintained and Momentary Action (SPDT)

Termination Options

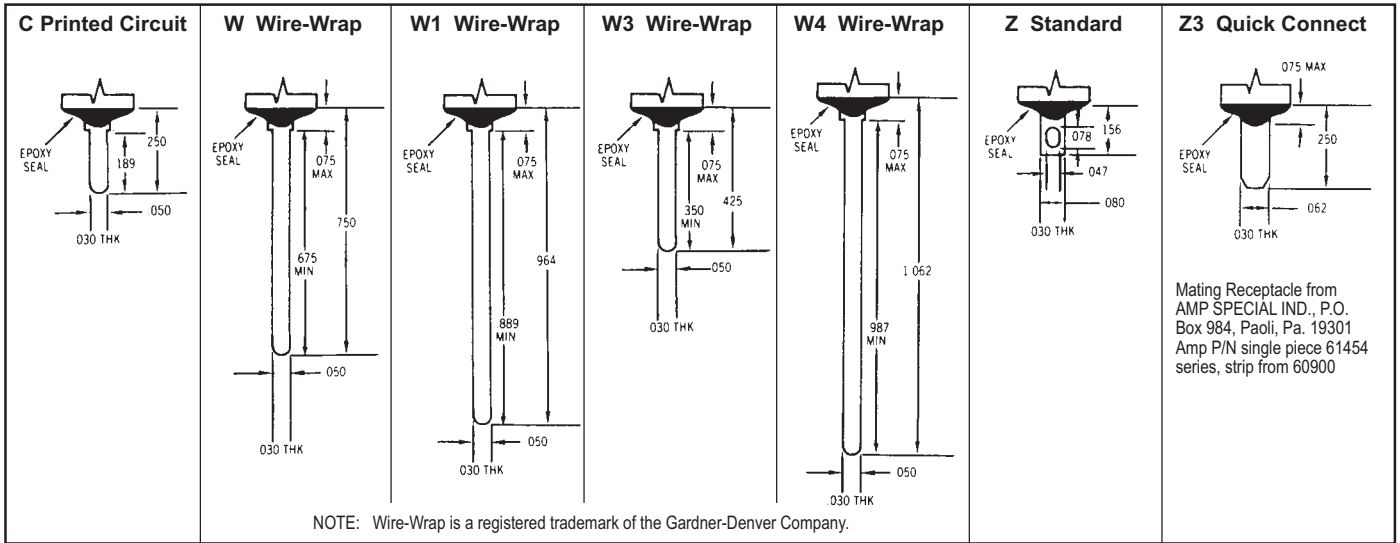

APPROXIMATE DIMENSIONS

PB, PBS, PBW SWITCHES w/"A" TYPE RIGHT ANGLE P.C. TERMINALS

DIM.	PB-123	PB-126
"A"	.561	.514
"B"	.108	.098

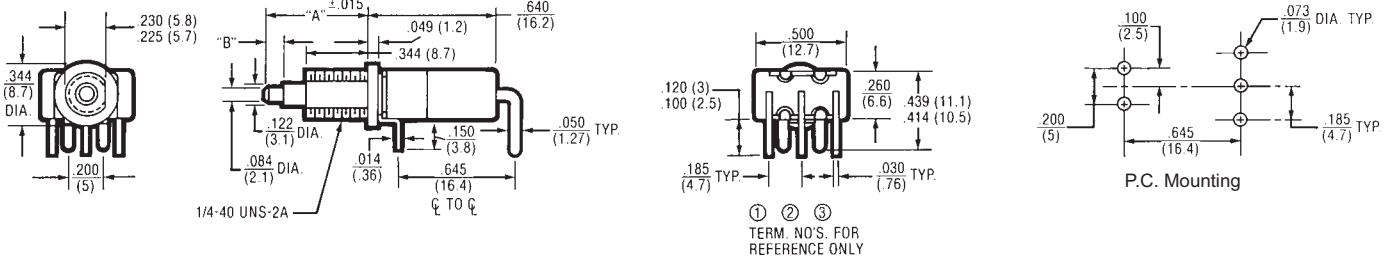

EPOXY SEALED P.C. TERMINALS ARE SUPPLIED AS STANDARD FOR THESE OPTIONS

PB, PBS, PBW SWITCHES w/ "AV" (.100" TERMINAL SPACING) OR "AV2" (.150" TERMINAL SPACING) TYPE VERTICAL P.C. TERMINALS

DIM.	PB-123	PB-126
"A"	.561	.514
"B"	.108	.098

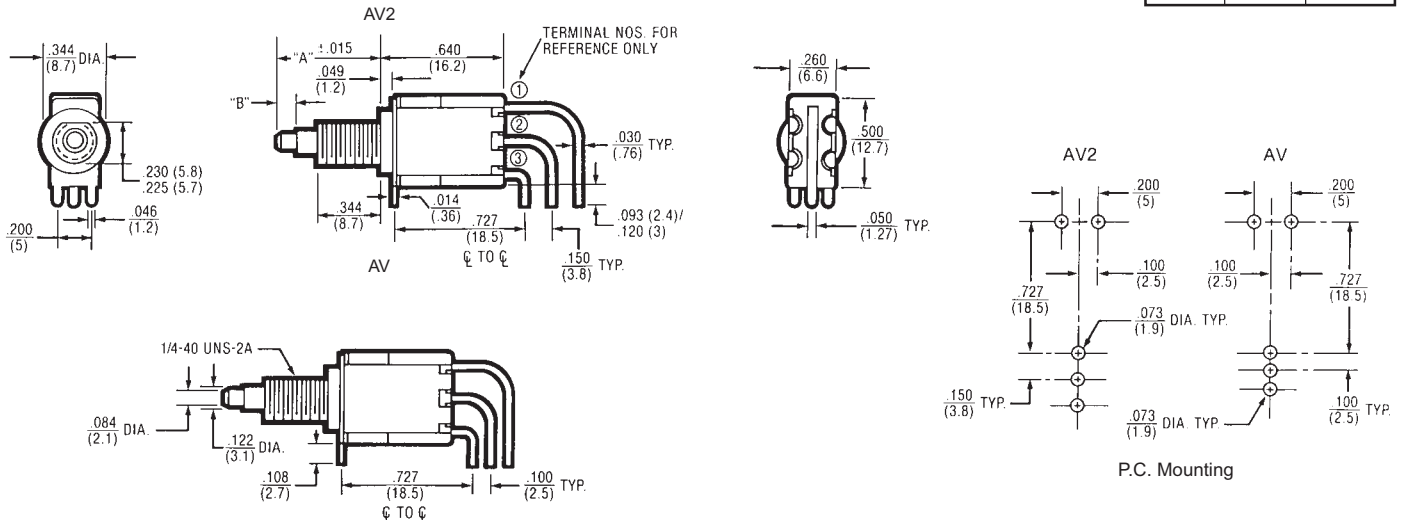

EPOXY SEALED P.C. TERMINALS ARE SUPPLIED AS STANDARD FOR THESE OPTIONS

Pushbutton Switches — Panelmount Maintained and Momentary Action (SPDT)

PUSHBUTTON CAP STYLES FOR PB SERIES SWITCHES ON PAGE 14

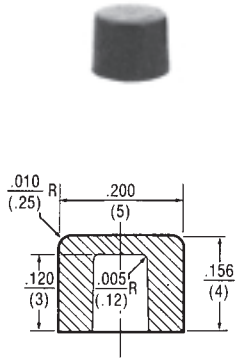

PART NUMBER	COLOR
W-KN-12	BLACK
W-KN-12A	WHITE
W-KN-12B	RED
W-KN-12C	GREEN ①
W-KN-12D	BLUE
W-KN-12E	DK. GRAY
W-KN-12F	YELLOW
W-KN-12G	LT. GRAY

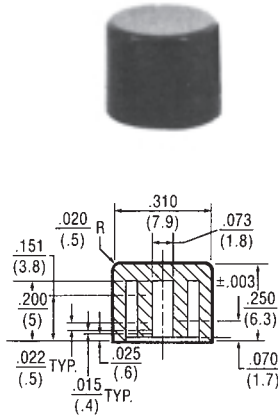

PART NUMBER	COLOR
W-KN-31	BLACK
W-KN-31A	WHITE
W-KN-31B	RED
W-KN-31C	GREEN ①
W-KN-31D	BLUE
W-KN-31E	DK. GRAY
W-KN-31F	YELLOW
W-KN-31G	LT. GRAY

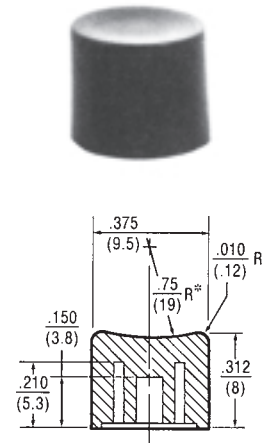

PART NUMBER	COLOR
W-KN-14	BLACK
W-KN-14A	WHITE
W-KN-14B	RED
W-KN-14C	GREEN ①
W-KN-14D	BLUE
W-KN-14E	DK. GRAY
W-KN-14F	YELLOW
W-KN-14G	LT. GRAY

① Black, white, red are standard. Contact Electros witch for availability on other colors shown.

DECORATIVE FACENUTS FOR PB SERIES AND PS SERIES

PART NUMBER W-NU-29A
(For .310 Dia. Caps)

Part No. W-NU-29A
Assembled to PB
Series Switch.

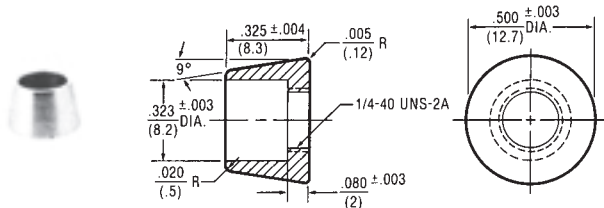

Finish: Bright chrome plate over brass

PART NUMBER W-NU-30A
(For .375 Dia. Caps)

Part No. W-NU-30A
Assembled to PS
Series Switch.
(See page 4)

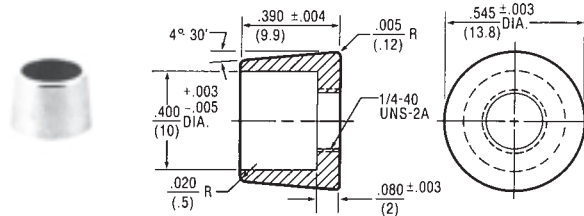

Finish: Bright chrome plate over brass

Sub Miniature Pushbutton Switches for Printed Circuit Boards — Wave Solderable Series B8000 PCB Pushbutton Switches

SPECIFICATIONS

- Mechanical life — 500,000 operations minimum
- Contact resistance — 25 milliohms maximum
- Dielectric strength — 1000 VAC rms
- Ambient temperature range — -20°C to +70°C
- Weight — 0.06 ounces (1.7 grams)
- Electrical life — 100,000 operations minimum.

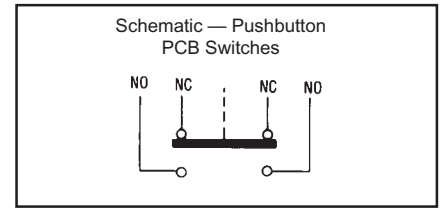

SELECTION TABLES (Bold Face Type indicates items normally in Distributor Stock)

Note: Optional Snap-On button must be ordered separately  B8500/B8600	Poles & Throw	Operation	Catalog No. By Terminal Type			
			Right Angle P.C. Mount	P.C. Stand Up Mount		
				.220" (5.6 mm)	.160" (4.1 mm)	.120" (3.1 mm)
	2 Circ.	Momentary or Latch Down ①	B8103			
	Momentary or Latch Down ①		B8500			
	Momentary		B8600			

OPTIONAL BUTTON CAPS

Button Cap Color	Catalog Number
Black	P281B
Red	P281R

CURRENT RATINGS

Nominal Rating, Amperes			
6 VDC	12 VDC	28 VDC	125 VDC
1	1	0.5	0.5

① For Latch-Down, depress plunger and rotate 30° clockwise.

NOTE: For special .5 VA max. rating @ 28 VAC or DC contact Electroswitch.

APPROXIMATE DIMENSIONS

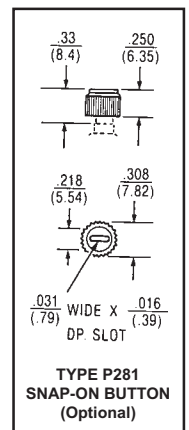
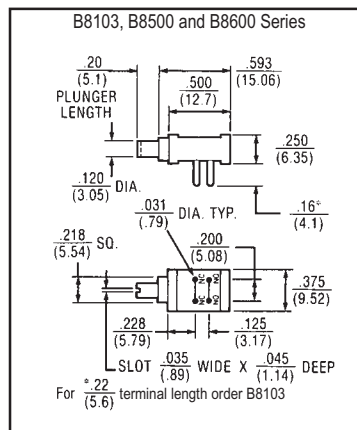
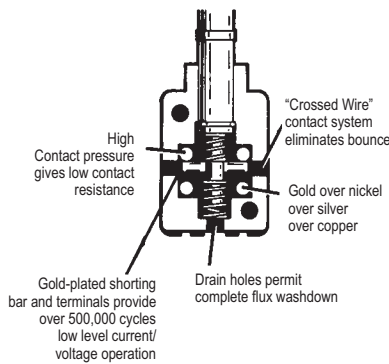

Ultra-Miniature Pushbutton Switches AC and DC — Round Base

SPECIFICATIONS

- Resistive rating — .75 amperes resistive at 125 VAC normally open; .50 amperes resistive at 125 VAC normally closed; also rated 1.0 ampere normally open for 15,000 operations and .75 amperes normally closed for 10,000 operations. For 28 VDC rating 1.5 amperes normally open for 10,000 operations and 1.0 ampere normally closed for 10,000 operations. Dry circuit rated 10 milliamperes at 30 mVDC.
- Pretravel — .015 minimum/.050 maximum
- Overtravel — .030 minimum
- Operating force — 8 oz. maximum
- Electrical life — 50,000 operations minimum
- Mechanical life — 50,000 operations minimum
- Materials — contacts and terminals are gold plated copper
- Mounting hardware — One #8-40 nut supplied unassembled

APPROXIMATE DIMENSIONS

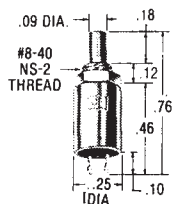

ACTUAL SIZE

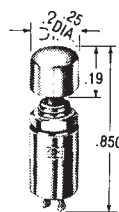

OPTIONAL BUTTON CAP MUST BE ORDERED SEPARATELY

SELECTION TABLE

Circuit	Plunger Color	Catalog Number
N.O.	Red	SA1RV20
N.O.	Black	SA1BV20
N.O.	Black	SA1BW20
N.O.	Red	SA1RW20

OPTIONAL BUTTON CAPS

Button Cap Color	Catalog Number	Description
Red	SW53AA1	.250" Slip on cap for SA1 series
Black	SW53AA2	.250" Slip on cap for SA1 series

CAUTION — MANUAL SWITCHES ARE AFFECTED BY HEAT, CLEANING SOLVENTS AND FLUX. EXTREME CARE SHOULD BE EXERCISED DURING HAND SOLDERING AND WAVE SOLDERING TO PREVENT SWITCH CONTAMINATION.

Keylite* Pushbutton Switches — Illuminated or Non-Illuminated

STANDARD TYPES



SLOPE KEYS — NARROW



SLOPE KEYS — WIDE



STEP KEYS — NARROW



STEP KEYS — WIDE



HALF KEYS — NARROW
(12 mm)



WINDOW KEYS — WIDE
(17 mm) Replaceable Legends



COLORED INSERTS

* Trademark of LUCAS N.S.F. Limited

SPECIFICATIONS

- Ratings** — Switch — 10mA at 24 VDC.
- Mechanical Life and Electric Life** — 5 million operations momentary, 10,000 maintained
- Initial Contact Resistance** — 50 milliohms max.
- Insulation Resistance** — 10⁹ Ohms minimum
- Contact Bounce** — 2.0 ms maximum
- Operating Force** — 150 grams approx.
- Total Key Travel** — .098 (2.5 mm)
- Pre-Travel** — .039 (1 mm)
- Ambient Temperature** — -25°C to +85°C
(-13°F to +185°F)
- Mounted Method** — Direct soldering onto standard Matrix printed circuit board.
- Interchangeable Keys** — Large variety of colors

MATERIALS

- Housing** — Polycarbonate
- Key Cap** — ABS
- Switching Contacts** — Gold plate over silver plated brass.

CAUTION AND

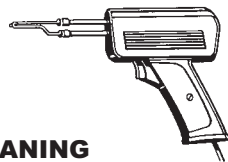

RECOMMENDATIONS

FOR SOLDERING AND CLEANING

Contamination of the contacts of miniature switches is the most common cause of problems in low energy circuits. This is due to the inability of current to flow through the increased resistance of the switch contacts due to the contamination. As most contamination occurs during the installation and cleaning of the switch, proper care when installing the switch can reduce problems in this area. The following procedures should be followed to reduce the possibility of switch contact contamination.

Hand Solder

1. Use rosin core solder .030" — .040" diameter.
2. A small soldering iron in the 30 to 40 watt range should be used.
3. The solder joint should not be overheated.
4. Do not position switch with terminations straight up.
5. No clean up should be necessary. However, if used, do not allow solvents to enter non-sealed areas of switch.

Wave solder — Miniature Switches

Do not immerse or spray with solvents to remove flux except for switches designed for this type of cleaning.
The use of wave solder oil is not advised.

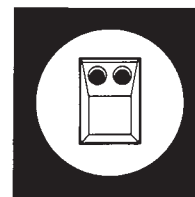

Clean Lines
Positive Tactile
Action, Bright
LED Indicators



Keys Are Detachable
and Interchangeable
with Improved
Push-On Design



Stand-Off Lugs
Minimize
Solder-Creepage

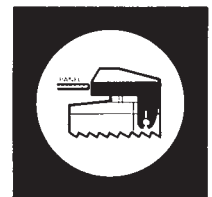

Half Key Feature

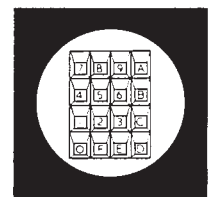

RECOMMENDED KEY REMOVAL METHOD
1. Operate switch. 2. Insert small screwdriver into resulting gap at 'A'. 3. Gently twist.
NOTE: When removing keys from within a matrix e.g. No. 3 above, first remove Nos. 9 and 6 by the above method then remove No. 3.

LED SPECIFICATIONS			
Color	Red	Green	Yellow
Maximum ratings			
Forward current	30mA	30mA	30mA
Forward voltage	3.0 @ 10mA	3.0 @ 20mA	3.0 @ 10mA
Intensity (typical)	2.0 mcd @ 10mA	1.5 mcd @ 20mA	2.0 mcd @ 10mA

Keylite* Pushbutton Switches — Illuminated or Non-Illuminated

KEYLITE ORDERING GUIDE — For assembled switches

Poles and Throw	Contact Operation	Base Catalog Number	Suffix Numbers — Add to Base Catalog Number						Other Features		
			LED Colors and Quantity		Operator Key Style and Number or LED's			Operator Key Color			
			Description	Suffix Number	Style	Number of LED Holes	Suffix Number	Color	Suffix Number	Feature	Suffix Number or Letter
1PDT	Momentary	SB6SDV	One Red, Narrow Spacing ①	14	Slope, Narrow	None	1A	White	1	Colored Inserts	Applicable to Key Styles 2E, 4E & 6E Only
			One Red, Wide Spacing ②	15	Slope, Wide	None	2A				
			One Green, Narrow Spacing ①	24	Slope, Narrow	One	3A				
			One Green, Wide Spacing ②	25	Slope, Wide	One	4A				
			One Yellow, Narrow Spacing ①	34	Step, Narrow	None	1D				
			One Yellow, Wide Spacing ②	35	Step, Wide	None	2D				
			Two Red ③	44	Step, Narrow	One	3D				
			Two Green ③	54	Step, Wide	One	4D				
			Two Red ③	44	Step, Narrow	Two	5D				
			Two Green ③	54	Step, Wide	Two	6D				
			No LED	64	Half, Narrow	None	1B				
			Two Yellow ③	74	Half, Wide	One	2B				
				74	Half, Narrow	Two	3B				
			One Red, One Green ③④	84	Window, Wide	None	2C				
			One Red, One Yellow ③④	94	Window, Wide	One	4C				
	94	Window, Wide	Two	6C							
One Green, One Yellow ③④	04	Colored, Wide Insert	None	2E							
	04	Colored, Wide Insert	One	4E							
	04	Colored, Wide Insert	Two	6E							
		Paddle Key	None	1F							
		Paddle Key	One	2F							
		Paddle Key	Two	3F							
		Illuminated paddle Key	No Light Bars	1G							
		Illuminated Paddle Key	One Light Bar	2G							
		Illuminated Paddle Key	Two Light Bars	3G							
		Slant Key	None	1H							

* Trademark of LUCAS N.S.F. Limited

FOOTNOTES

Mounting of LED's

- ① LED is mounted in center holes A(-) and B(+).
- ② LED is mounted in outer holes C(-) and D(+).
- ③ LED's are mounted in holes C(+) and A(-), holes B(-) and D(+).
- ④ Colored LED's are mounted left to right.

ORDERING EXAMPLES:

SB6SDV143A1 — Momentary switch, narrow spaced red LED, white narrow slope Key.

Keylite Switch Dimensions

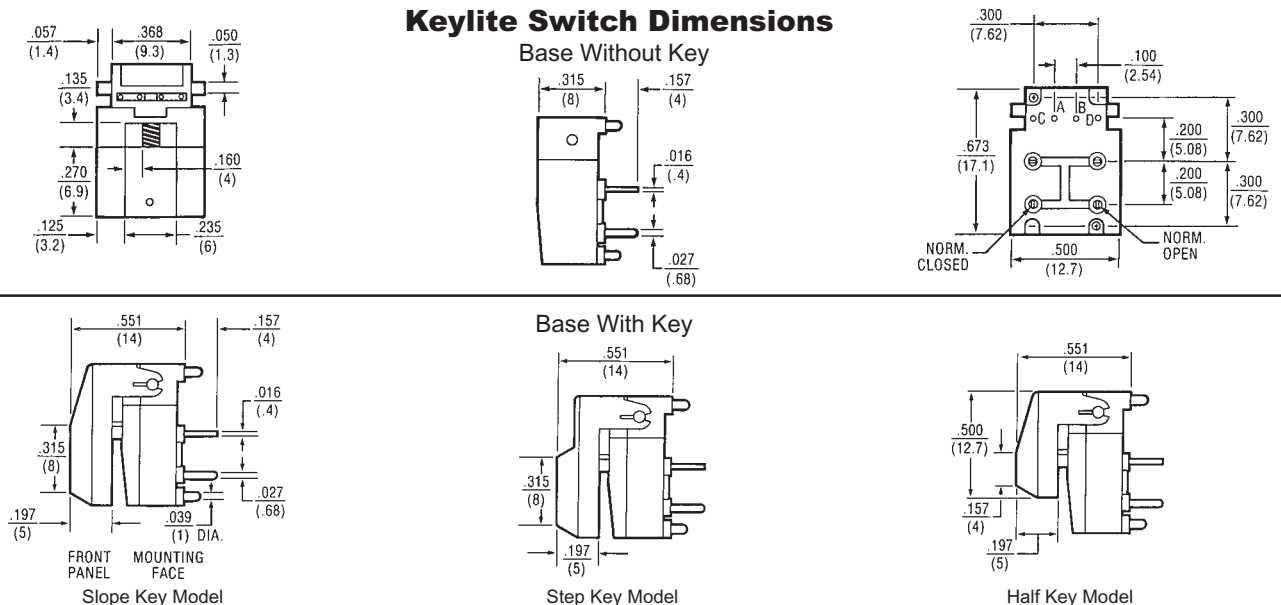

Keylite* Pushbutton Switches — Illuminated or Non-Illuminated

OPERATOR KEY SELECTION TABLE

Key Description	Key Dimensions	Momentary Action		Key Color	Color Code	
		Key Part Number	Number of LED Holes			
Narrow Slope Key		W-KN-21	None	Black	No letter Suffix	
		W-KN-22	1			
		W-KN-23	2			
Wide Slope Key		W-KN-24	None	White	A	
		W-KN-25	1			
		W-KN-26	2			
Narrow Step Key		W-KN-40	None	Red	B	
		W-KN-41	1			
		W-KN-42	2			
Wide Step Key		W-KN-43	None	Green	C	
		W-KN-44	1			
		W-KN-45	2			
Half Keys		W-KN-28	None	Blue	D	
		W-KN-29	1			
		W-KN-30	2			
Window Keys		W-KN-37	None	Gray	E	
		W-KN-38	1			
		W-KN-39	2			
Colored Insert Keys				Yellow	F	
			Orange			G

* Trademark of LUCAS N.S.F. Limited

Ordering Example: W-KN-21D is a blue narrow slope key w/no LED holes.
W-KN-45 is a black wide step key w/two LED holes.

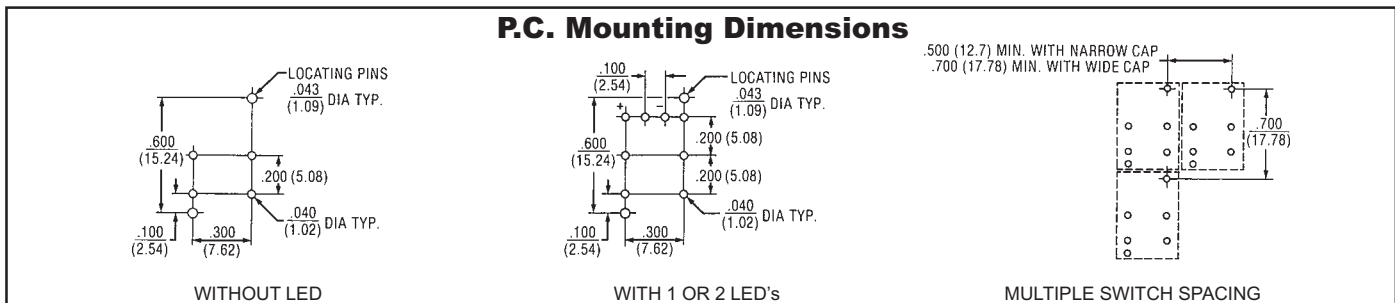

Keylite* Pushbutton Switches — Illuminated or Non-Illuminated

OPERATOR KEY SELECTION TABLE

Description	Key Dimensions	Key Part Number	Illuminated Features	Key Color	Suffix Code		
			Number of Light Bars				
<ul style="list-style-type: none"> LED's are mounted under the paddle Color of light bar determined by LED 		W-KN-68	None	Black	No letter Suffix		
		W-KN-69	1			White	A
		W-KN-70	2			White	A
<ul style="list-style-type: none"> LED's are mounted outside the paddle 		W-KN-71	Number of LED Holes	Red	B		
		W-KN-72	1	Green	C		
		W-KN-73	2	Blue	D		
<ul style="list-style-type: none"> No LED's 		W-KN-74	None	Gray	E		
				Yellow	F		
				Orange	G		

* Trademark of LUCAS N.S.F. Limited

Ordering Examples: W-KN-70E is a gray paddle key with 2 light bars.
W-KN-72D is a blue paddle key with 1 LED hole.
W-KN-74 is a black slant key.

ADDITIONAL KEYLITE OPTIONS

<p>STATIC SHIELDING</p> <ul style="list-style-type: none"> Static Shielding prevents static electricity from entering the circuit via the LED. Withstands up to 11,000 volts DC. Can be provided on any key style. 	
<p>SEALANT TAPE</p> <ul style="list-style-type: none"> Adhesive tape seals switches for wave soldering. Tape is discarded after wash. Key caps shipped unassembled. 	<p>CUSTOM INK STAMPING</p> <p>Available upon request.</p>

Keylite* Pushbutton Switches — Illuminated or Non-Illuminated

ADDITIONAL KEYLITE OPTIONS — KEYBARS

PANEL CUT-OUT

P.C. BOARD LAYOUT

DIMENSION: W/LED LOCATION HOLES

LED HOLE LOCATIONS
SEE NOTE 1.

ORDERING EXAMPLES

EXAMPLE:
W-KN-49G-ACE, is the orange key with LED holes in positions A, C, and E. (Shown at left)

EXAMPLE:
W-KN-49, is the black key with no LED holes.

Part No.	Color
W-KN-49*	Black
W-KN-49A*	White
W-KN-49B*	Red
W-KN-49C*	Green
W-KN-49D*	Blue
W-KN-49E*	Gray
W-KN-49F*	Yellow
W-KN-49G*	Orange
W-KN-49H*	Brown

*For LED holes see note 1

NOTE:

- Center LED holes (B, E) cannot be ordered with outer holes (A, C) or (D, F) respectively.
- Accommodates 2 switches.
- Standard LED hole is $\frac{150}{4}$ diameter

.99" (25 mm) KEYBAR

PANEL CUT-OUT

P.C. BOARD LAYOUT

DIMENSION: W/LED LOCATION HOLES

LED HOLE LOCATIONS
SEE NOTE 1.

ORDERING EXAMPLES

EXAMPLE:
W-KN-50C-BDF, is the green key with LED holes in positions B, D, and F. (Shown above)

EXAMPLE:
W-KN-50, is the black key with no LED holes.

Part No.	Color
W-KN-50*	Black
W-KN-50A*	White
W-KN-50B*	Red
W-KN-50C*	Green
W-KN-50D*	Blue
W-KN-50E*	Gray
W-KN-50F*	Yellow
W-KN-50G*	Orange
W-KN-50H*	Brown

*For LED holes see note 1

NOTE:

- Center LED holes (B, E) cannot be ordered with outer holes (A, C) or (D, F) respectively.
- Accommodates 2 switches.
- Standard LED hole is $\frac{150}{4}$ diameter

1.38" (35 mm) KEYBAR

PANEL CUT-OUT

P.C. BOARD LAYOUT

DIMENSION: W/LED LOCATION HOLES

LED HOLE LOCATIONS
SEE NOTE 1.

ORDERING EXAMPLES

EXAMPLE:
W-KN-51B-ACEH, is the red key with LED holes in positions A, C, E, and H. (Shown above)

EXAMPLE:
W-KN-51, is the black key with no LED holes.

Part No.	Color
W-KN-51*	Black
W-KN-51A*	White
W-KN-51B*	Red
W-KN-51C*	Green
W-KN-51D*	Blue
W-KN-51E*	Gray
W-KN-51F*	Yellow
W-KN-51G*	Orange
W-KN-51H*	Brown

*For LED holes see note 1

NOTE:

- Center LED holes (B, E, H) cannot be ordered with outer holes (A, C) or (D, F) or (G, J) respectively.
- Accommodates 3 switches.
- Standard LED hole is $\frac{150}{4}$ diameter

1.49" (37.8 mm) KEYBAR

* Trademark of LUCAS N.S.F. Limited

Ordering Table — Standard Rocker & Paddle Switches

HOW TO ORDER YOUR DESIGN (Bold Face Type indicates items normally in Distributor Stock)

Following the table from left to right, the designer is able to specify the options wanted. The options are described and illustrated on pages 24-31. Refer to page 57 for mounting hardware.

To determine a part number select the options desired and fill in the boxes in the selection guides illustrated below.

Rocker Switch Selection Guide

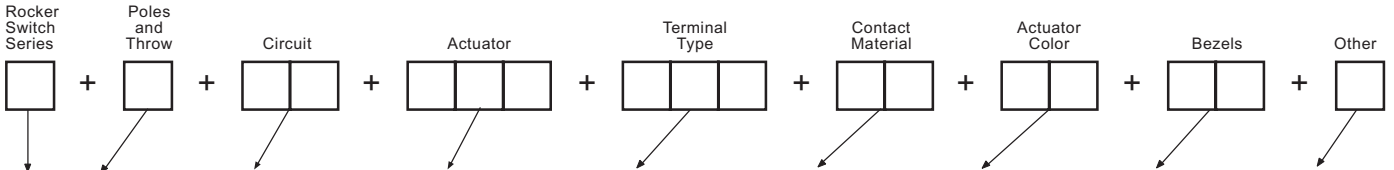

Series	Poles and Throw		Circuits 1				Actuator Options		Terminal Options 6		Contact Material		Actuator Color		Bezels		Other Option	
	No.	Code	Description			Code	Type	Code	Type	Code	Type	Code	Color	Code	Type	Code	Type	
B	SPDT	1			POS. "C"		Rocker 7 (Screw Mount)	J1	Right Angle PC 10	A	gold/brass	B	Dark Gray 4	0	Bright Chrome 3	1M	Epoxy Sealed Terminals 6	
	DPDT	2	ON	OFF	ON	21	Paddle 7 (Screw Mount)	J2	Vertical PC .100 Spacing	AV1	gold/silver	G	White	1	Black 3	2M		
	3PDT	3	ON	NONE	ON	23	Rocker 7 (Screw Mount)	J3	Vertical PC .150 Spacing	AV2	coin silver	Q	Black	2	Satin Chrome 3	3M		
	4PDT	4	ON	NONE	ON*	26	Paddle 7 (Screw Mount)	J5			12	K	Red	3	White 2	1P		
						27	Snap-In Mount Rocker With Bezel	J11	PC Terminals	C	12	L	Green 4	5	Black 2	2P		
						31	ON OFF ON*	J21	PC & Support 1	V3	12	M	Blue 4	6	Red 2	3P		
						32	ON ON ON*	J21	PC & Support 1	V4			Light Gray 4	8	Black w/LED 2	4P		
						33	ON ON ON*	J37	Vertical PC .150 Spacing	V5			Yellow 4	9	Green 2 4	5P		
						34 5	NONE ON ON*	J47	PC & Support 1	V6			Brown 4	10	Blue 2 4	6P		
			35	ON* ON ON*	J47	PC & Support 1	V7					Light Gray 2 4	8P					
			NONE	ON	ON	53 5	J50	Snap-In Rocker 1 7	J50	.750 Wire Wrap	W					Yellow 2 4	9P	
							J53	Snap-In Rocker 1 7	J53	.964 Wire Wrap	W1					Dark Gray 2 4	0P	
							J60	Snap-In Paddle 1 7	J60	.425 Wire Wrap	W3							
							J63	Snap-In Paddle 1 7	J63	1.062 Wire Wrap	W4							
							J71	Rocker Actuator 9	J71		Z							
	J72	Paddle Actuator 9					J72		Z									
	J73	Rocker Actuator 9	J73		Z3													
	J75	Paddle Actuator 9	J75															
	J76	Rocker Actuator 9	J76															
	J77	Paddle Actuator 9	J77															

*Momentary Contact

- 1** 1 and 2 pole only.
- 2** For J50 and J60 only.
- 3** For J11, J21, J37 and J47 only.
- 4** Consult plant for availability.
- 5** These circuits are **NOT** available with the following 3 and 4 pole options: A, AV1, AV2, V3, V4, V5, V6 and V7.
- 6** Epoxy seal standard on all terminal options.

- 7** Available with C, Z, Z3 or W-W4 terminations.
- 8** Available with AV1, AV2, V3-V7 terminations.
- 9** Available with A, AV1, AV2 or V3-V7 terminations.
- 10** 1, 2 and 3 pole only.
- 11** See page 58 for construction detail, wiring and electrical diagrams.
- 12** Same as B, G and Q respectively except terminals brass with tin nickel alloy over nickel plate. Consult plant for availability.

EXAMPLES:

- B121J71AQ2** = SPDT rocker switch with an ON-OFF-ON circuit, J71 style rocker (black), right angle P.C. terminals with coin silver contacts and epoxy sealed terminals.
- B223J50ZQ22P** = DPDT rocker switch with an ON-NONE-ON circuit, J50 style rocker (black), solder lug terminals with coin silver contacts, black snap in bezel and epoxy sealed terminals.

Standard Rocker & Paddle Switches — Specifications and Materials

SPECIFICATIONS

Contact Rating — Letter codes G and Q — 6 amp at 125 VAC, 3 amp @ 250 VAC, (U.L. recognized, CSA certified) or 6 amp at 28 VDC resistive.

Letter codes B and G — 0.5. volt-amp (VA) maximum @ 28 V maximum (AC or DC).

Life Under Load — 60,000 make-and-break cycles — resistive load only.

Initial Contact Resistance — 10 milliohms maximum. 3 VDC, 100 ma for both silver and gold plated contacts.

Insulation Resistance — 1 & 2 pole — 1,000 megohms minimum.
3 & 4 pole — 1,000 megohms minimum.

Dielectric Strength — 1,000 volts rms at sea level.

Operating Temperature — 30° to +85°C

MATERIALS

Base (body) — 1- and 2-pole — Diallyl Phthalate. (DAP).
3- and 4-pole — high strength phenolic.

Rocker/Paddle — Molded nylon.

Bushing — Brass, nickel plated.

Clamp (frame) — Stainless steel.

Support Bracket — Steel, tin plated.

Metal Bezel — Spring steel.

Plastic Bezel — Molded nylon.

Switching Contacts and Rockers —

Letter Code B — gold/nickel/brass

Letter Code G — gold/nickel/silver

Letter Code Q — Coin silver

Center Terminal

Letter Codes B, G — Gold flash/nickel/brass

Letter Code Q — Silver plated brass.

Hardware — See page 57.

APPROXIMATE BASE DIMENSIONS

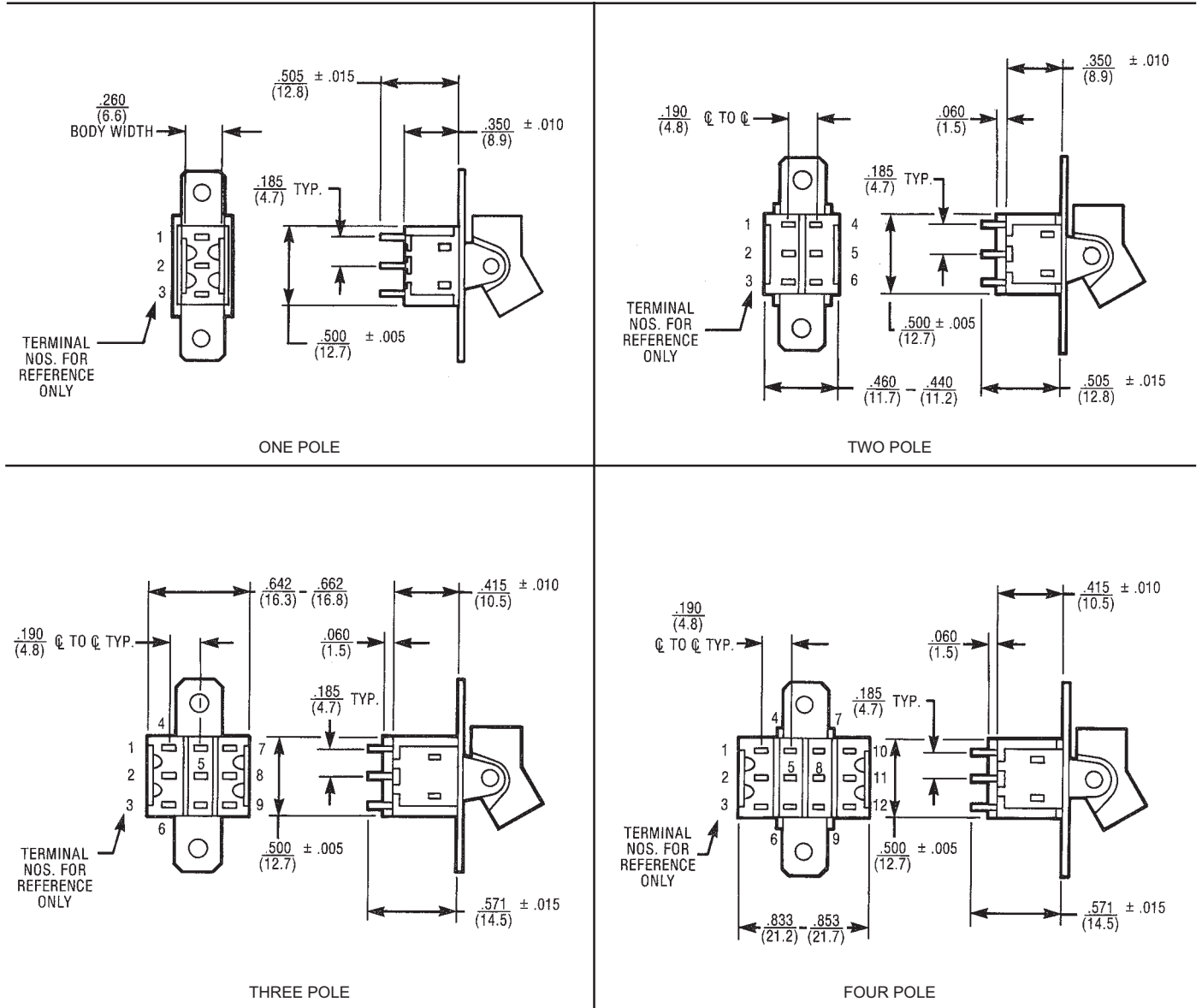

Rocker Actuator Options For P.C. Mounting

<p>J71</p>	<p>J72</p>
<p>J73</p>	<p>J75</p>
<p>J76</p>	<p>J77</p>

ACTUATOR/MOUNTING OPTIONS

<p>J1 Screw Mount Rocker</p>	<p>Refer to Page 57 for Mounting Hardware</p>
<p>J2 Screw Mount Paddle Rocker</p>	<p>Refer to Page 57 for Mounting Hardware</p>
<p>J3 Screw Mount Large Rocker</p>	<p>Refer to Page 57 for Mounting Information</p>
<p>J5 Screw Mount Large Tapered Paddle Rocker</p>	<p>Refer to Page 57 for Mounting Hardware</p>

Actuator and Mounting Options — Cont'd

J11 Rocker with Snap-In Bezel ①

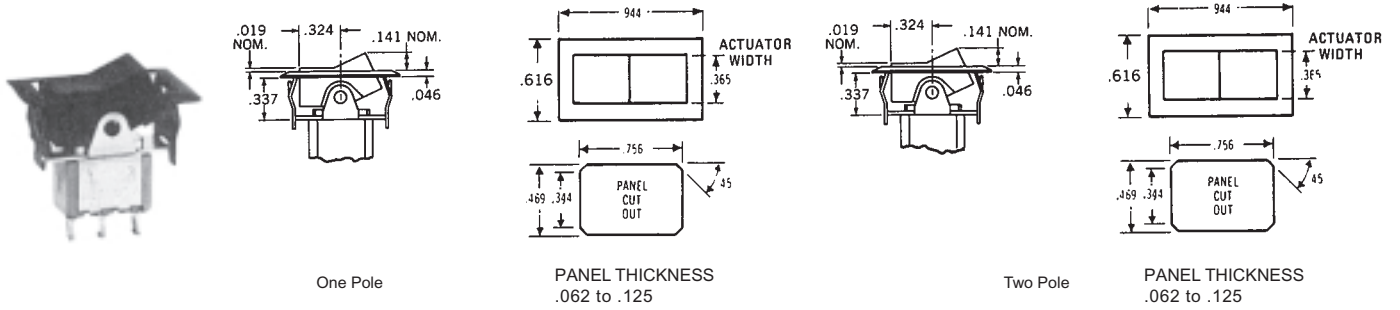

J21 Paddle with Snap-In Bezel ①

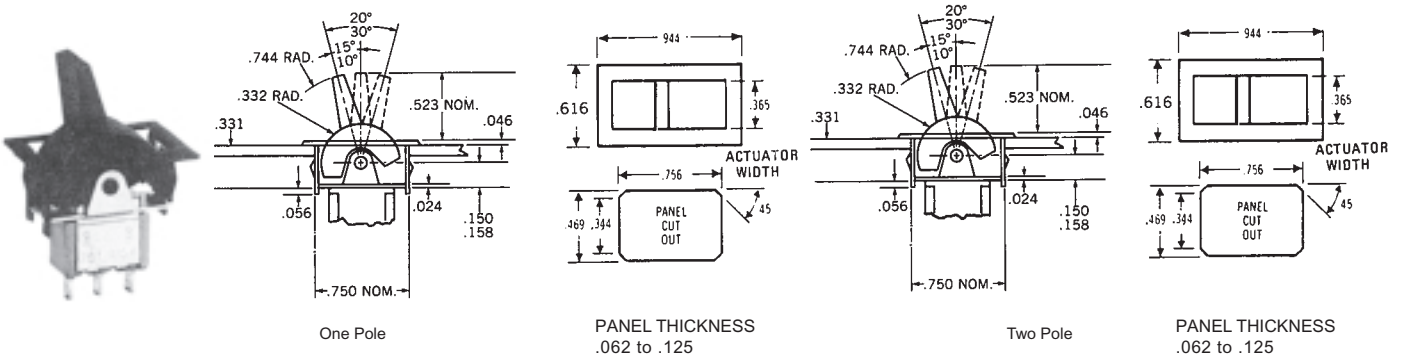

J37 Rocker Actuator/Mounting Option

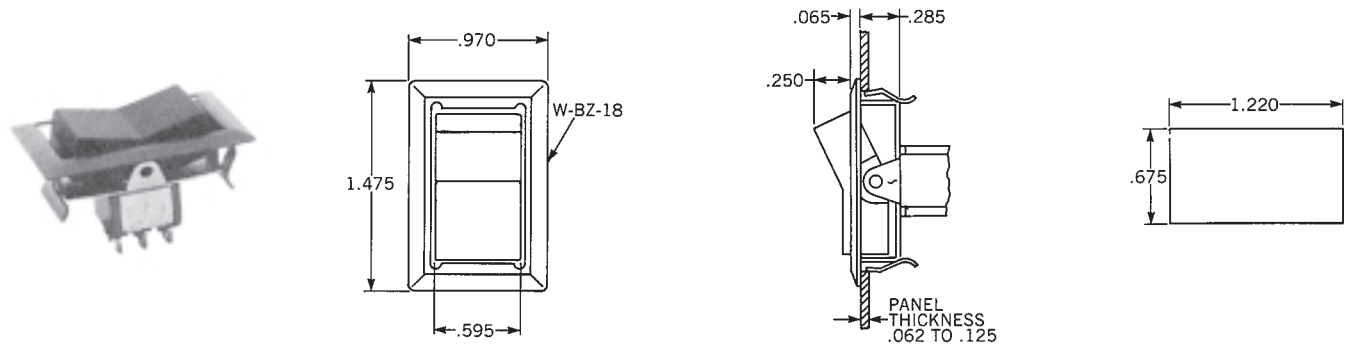

J47 Paddle Actuator/Mounting Option

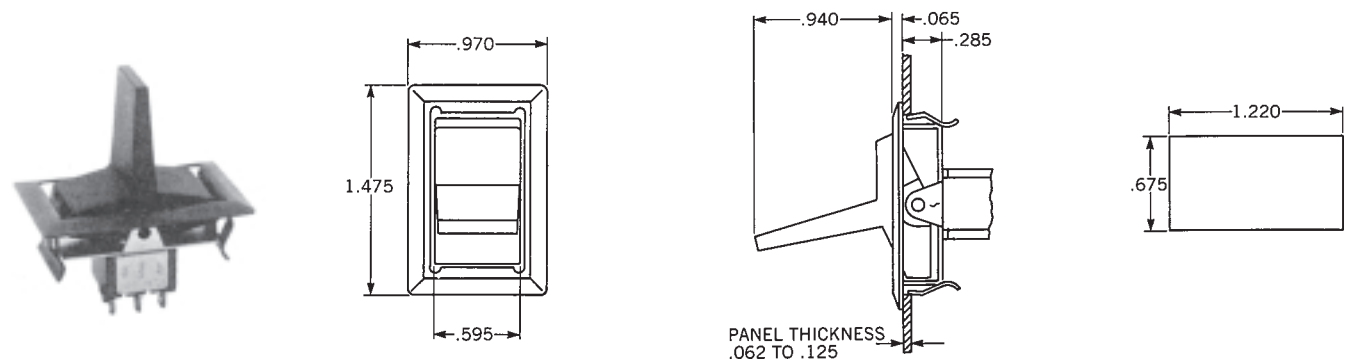

① Three and four pole switches require assembly from back of panel.

Actuator and Mounting Options

J50 = Snap in Mounting w/Low Profile Rocker ①
J60 = Snap in Mounting w/Low Profile Paddle

J50 Rocker Style **J60** Paddle Style

J53 = Snap in Mounting w/High Profile Rocker ①
J63 = Snap in Mounting w/High Profile Paddle

J53 Rocker Style **J63** Paddle Style

OPTIONAL BEZELS (For use with J50/J60 Series only)

Bezel Assembled with J50/J60 Series

J50 Rocker Style w/Bezel **J60** Paddle Style w/Bezel

Color	Code	Part No.
White	1P	W-BZ-12A
Black	2P	W-BZ-12
Red	3P	W-BZ-12B

Bezel for L.E.D. Assembled with J50/J60 Series (Note: LED is not supplied)

J50 Rocker Style w/Bezel for L.E.D. **J60** Paddle Style w/Bezel for L.E.D.

Color	Code	Part No.
Black	4P	W-BZ-15

OPTIONAL MOUNTING CLIP (For use with J50/J60 Series only)

Clip Assembled with J50/J60 Series

- For thick plastic panel mount applications (.094" - .125" thick)
- Consult factory for availability

① All rocker switches on this page are snap-in from the front of the panel. No behind panel assembly hardware is needed.

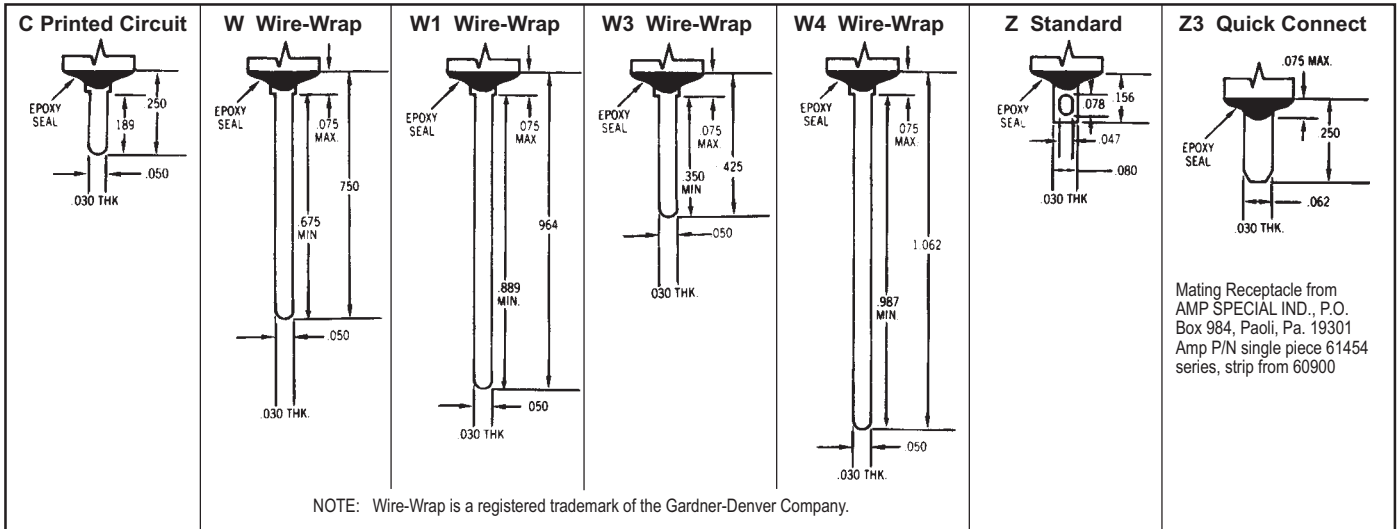

TERMINATION/MOUNTING OPTIONS

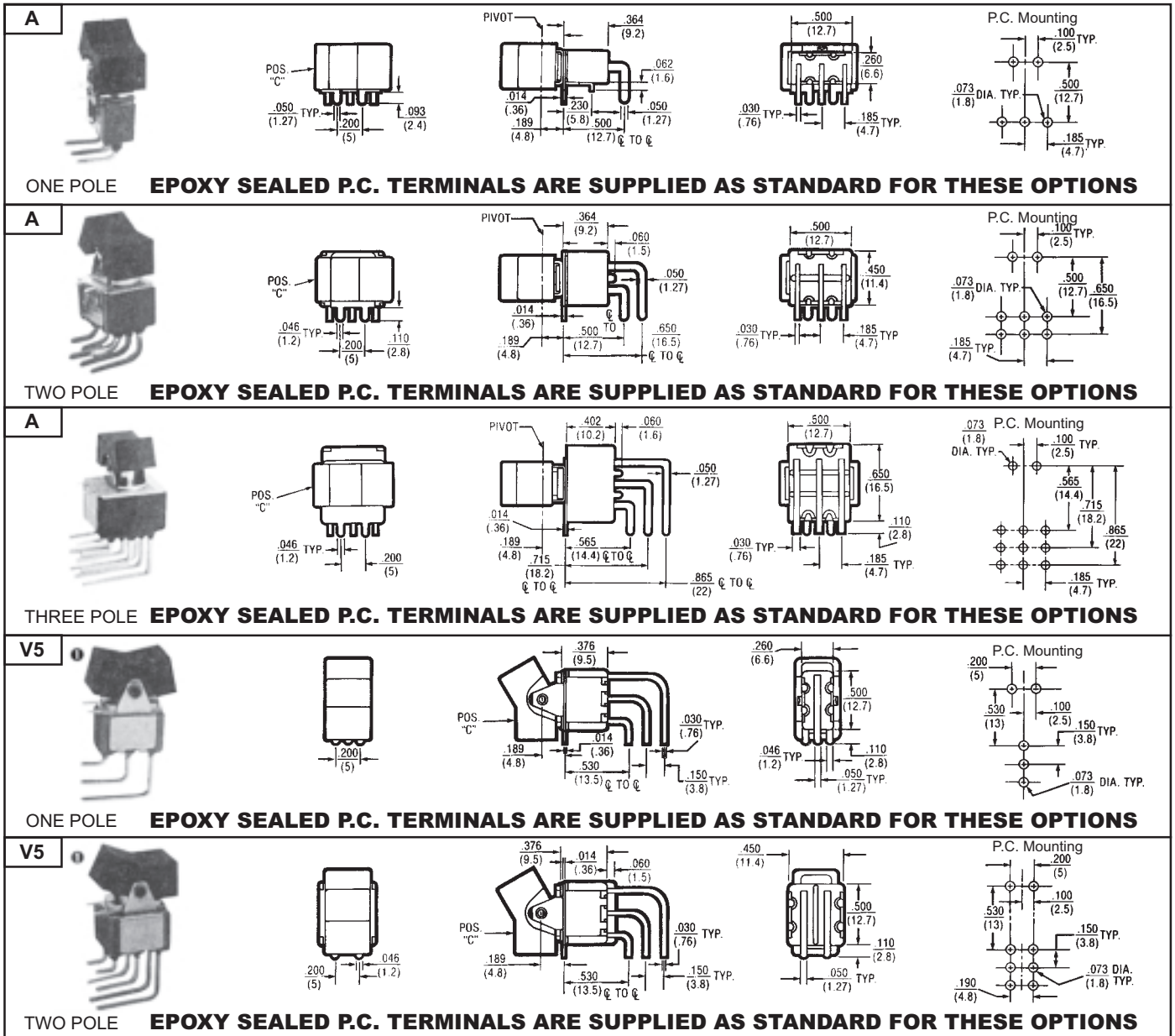

① The V5 option is available in Three and Four Pole Circuits.

Termination/Mounting Options

AV1 w/.100" Terminal Spacing
AV2 w/.150" Terminal Spacing (Pictured Below)

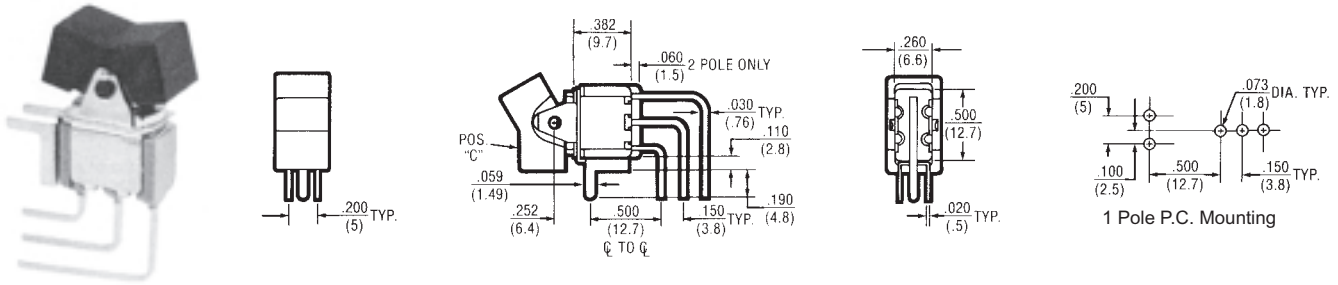

ONE POLE **EPOXY SEALED P.C. TERMINALS ARE SUPPLIED AS STANDARD FOR THESE OPTIONS**

AV1 w/.100" Terminal Spacing
AV2 w/.150" Terminal Spacing (Pictured Below)

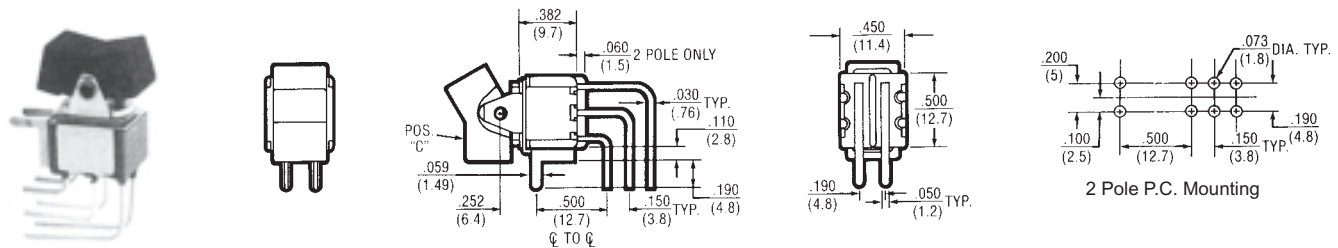

TWO POLE **EPOXY SEALED P.C. TERMINALS ARE SUPPLIED AS STANDARD FOR THESE OPTIONS**

AV1 w/.100" Terminal Spacing
AV2 w/.150" Terminal Spacing (Pictured Below)

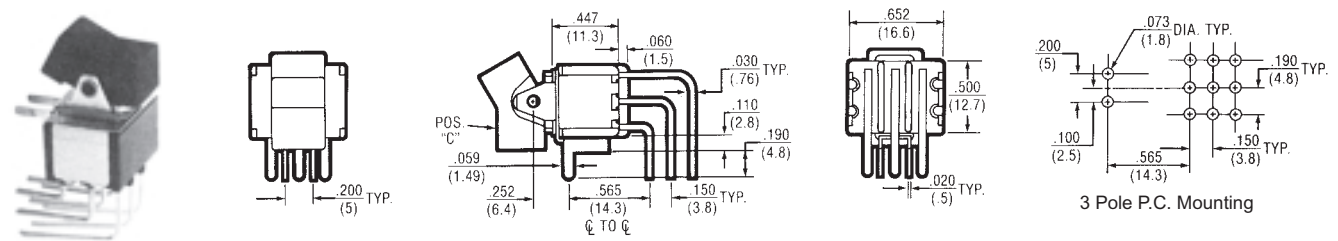

THREE POLE **EPOXY SEALED P.C. TERMINALS ARE SUPPLIED AS STANDARD FOR THESE OPTIONS**

AV1 w/.100" Terminal Spacing
AV2 w/.150" Terminal Spacing (Pictured Below)

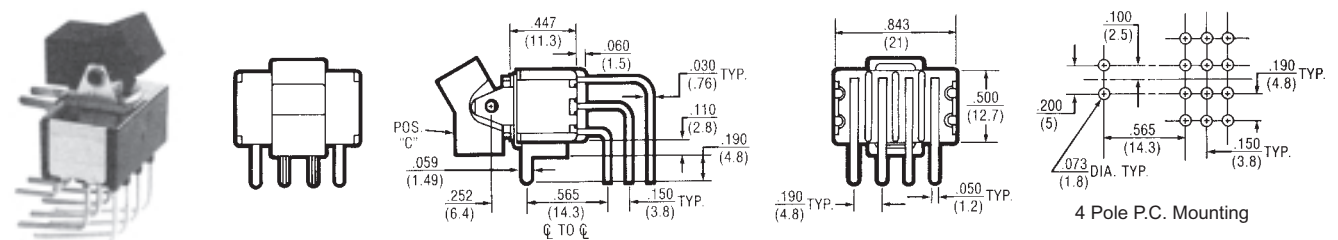

FOUR POLE **EPOXY SEALED P.C. TERMINALS ARE SUPPLIED AS STANDARD FOR THESE OPTIONS**

V3

1 Pole P.C. Mounting
2 Pole P.C. Mounting

EPOXY SEALED P.C. TERMINALS ARE SUPPLIED AS STANDARD FOR THESE OPTIONS

V4

1 Pole P.C. Mounting
2 Pole P.C. Mounting

EPOXY SEALED P.C. TERMINALS ARE SUPPLIED AS STANDARD FOR THESE OPTIONS

V6

1 Pole P.C. Mounting
2 Pole P.C. Mounting

EPOXY SEALED P.C. TERMINALS ARE SUPPLIED AS STANDARD FOR THESE OPTIONS

V7

1 Pole P.C. Mounting
2 Pole P.C. Mounting

EPOXY SEALED P.C. TERMINALS ARE SUPPLIED AS STANDARD FOR THESE OPTIONS

Ordering Table — Washable Rocker & Paddle Switches

Designed to be wave soldered along with other Printed Circuit Board Components and withstand associated cleaning processes.

HOW TO ORDER YOUR DESIGN (Bold Face Type indicates items normally in Distributor Stock)

Following the table from left to right, the designer is able to specify the options wanted. The options are described and illustrated on the following pages.

To determine a part number select the options desired and fill in the boxes in the selection guides illustrated below.

Washable Rocker/Paddle Switch Selection Guide

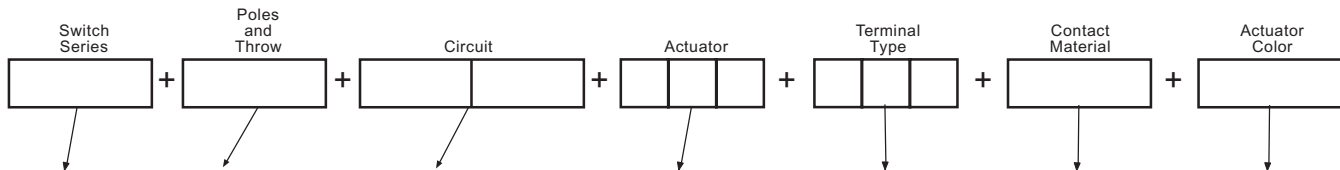

Series		Poles and Throw		Circuits ③				Actuator Options		Terminal Options		Contact Material		Actuator Color	
Type	Code	No.	Code	Description			Code	Type	Code	Type	Code	Type	Code	Type	Code
Rocker	WR	SPDT	1			POS. "C"		Rocker ⑤ (Screw Mount)	J1	Right Angle PC	A	Gold/Brass	B	White	1
Paddle	WP	DPOT	2	ON	OFF	ON	21	Paddle ⑤ (Screw Mount)	J2	Vertical PC .150 Spacing	AV2	Gold/Silver	G	Black	2
				ON	NONE	ON	23	Rocker Actuator ⑥	J71	PC Terminals	C	Coin Silver	Q	Other ②	
				ON	NONE	ON*	26		Paddle Actuator ⑥	J72	PC & Support	V3	④		K
				ON*	OFF	ON*	27	Rocker Actuator ⑥		J76	.750 Wire Wrap	W	④	L	
				ON	OFF	ON*	31		Paddle Actuator ⑥	J77	.964 Wire Wrap	W1	④	M	
				ON	ON	ON	32 ①				.425 Wire Wrap	W3			
				ON	ON	ON*	33 ①			1.062 Wire Wrap	W4				
				ON*	ON	ON*	35 ①			Solder Lug	Z				
										Quick Connect	Z3				

*Momentary Contact.

- ① 2 Pole Only.
- ② Contact Electroswitch for availability.
- ③ Refer to page 59 for circuit diagram.
- ④ Same as B, G, and Q respectively except terminals brass with fine nickel alloy over nickel plate. Consult factory for availability.
- ⑤ Available with C, Z, Z3, W-W4 termination.
- ⑥ Available with A, AV2, V3, termination.

EXAMPLES:

- WR123J71AQ2** = SPDT rocker switch with an ON-NONE-ON circuit, J71 style rocker actuator (black), right angle P.C. terminals with coin silver contacts.
- WP227J2CG2** = DPDT paddle switch with an ON*-OFF-ON* circuit, J2 style paddle actuator (black), screw-in direct panel mounting frame, P.C. terminals with gold/silver contacts.

SPECIFICATIONS:

Contact Ratings — Letter codes G and Q — 6 amp at 125 VAC, 3 amp @ 250 VAC (U.L. recognized, CSA certified) or 6 amp at 28 VDC resistive. Letter codes B and G — 0.5. volt-amp (VA) maximum @ 28 V maximum (AC or DC).

Life Under Load — 60,000 make-and-break cycles — resistive load only.

Initial Contact Resistance — 10 milliohms maximum 3 VDC, 100 ma for both silver and gold plated contacts.

Insulation Resistance — 1,000 megohms, min.

Dielectric Strength — 1,000 volts rms at sea level.

Operating Temperature — -30 degrees C to 85 degrees C.

MATERIALS:

Base & Bushing — Thermoplastic high temperature (UL 94V-O).

Rocker/Paddle — Molded nylon.

Mounting Bracket — Molded nylon.

Support Brackets — Brass or steel tin plated.

Switching Contacts and Rockers — Letter Code B — gold/nickel/brass
Letter Code G — gold/nickel/silver
Letter Code Q — Coin silver

Center Terminal
Letter Codes B & G — Gold flash/nickel/brass
Letter Code Q — Silver plated brass.

Hardware — Two mounting screws, two nuts, two spacers for .094" thick panel, and two lockwashers are supplied standard on screw mounted switches.

Washable Rocker & Paddle Switches

TERMINATION OPTIONS

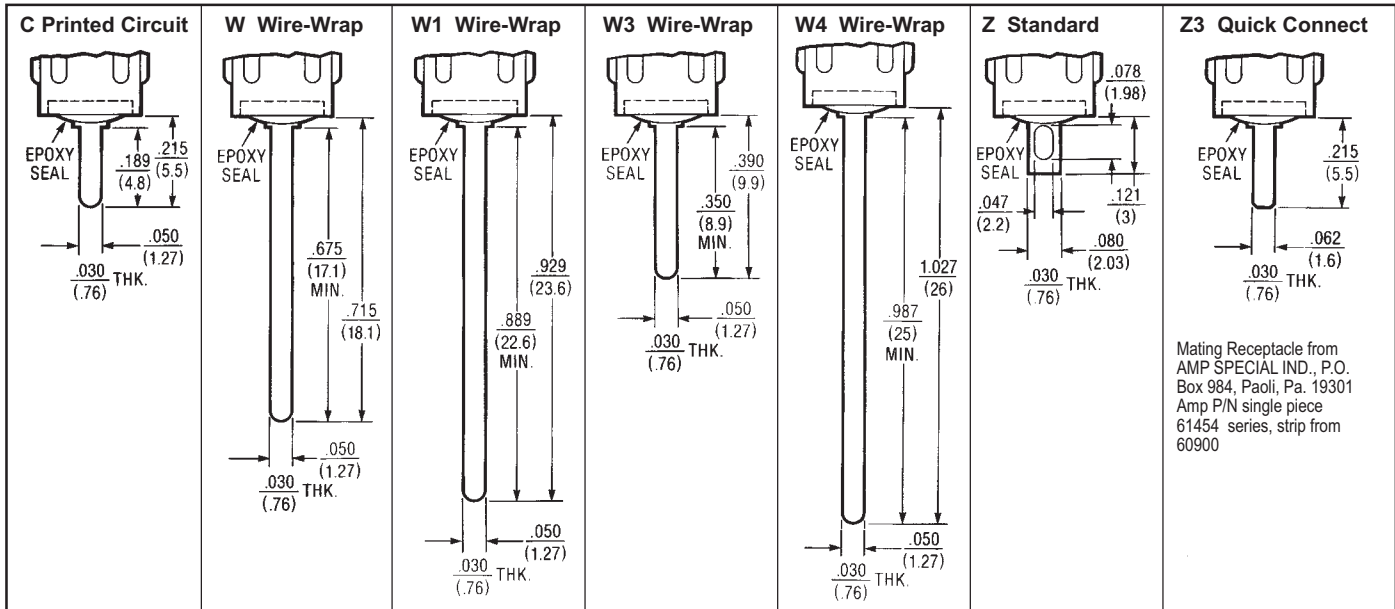

NOTE: Wire-Wrap is a registered trademark of the Gardner-Denver Company.

TERMINATION & MOUNTING OPTIONS

A



ONE POLE

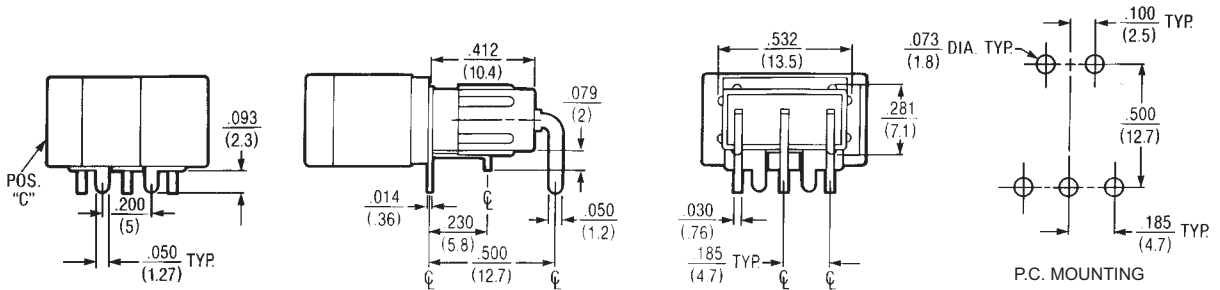

A



TWO POLE

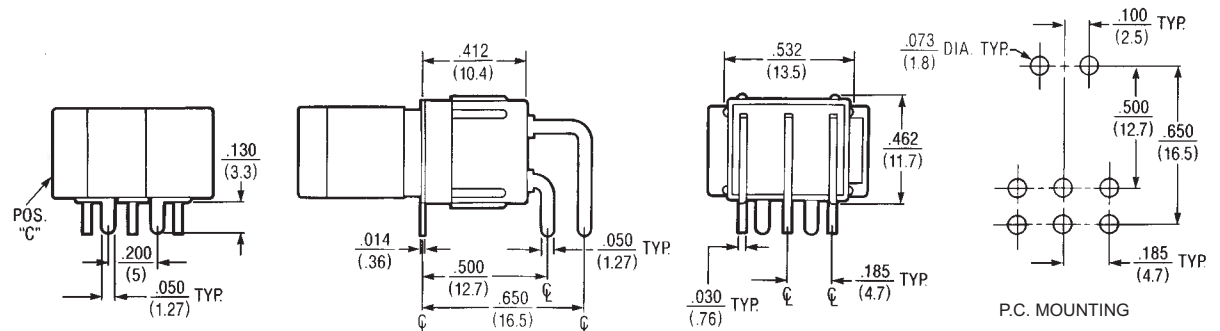

TERMINATION & MOUNTING OPTIONS — Contd.

AV2



ONE POLE

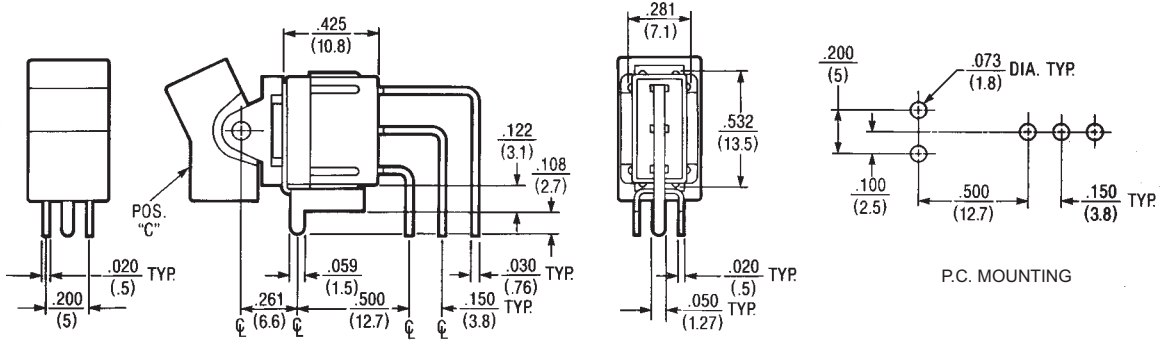

AV2



TWO POLE

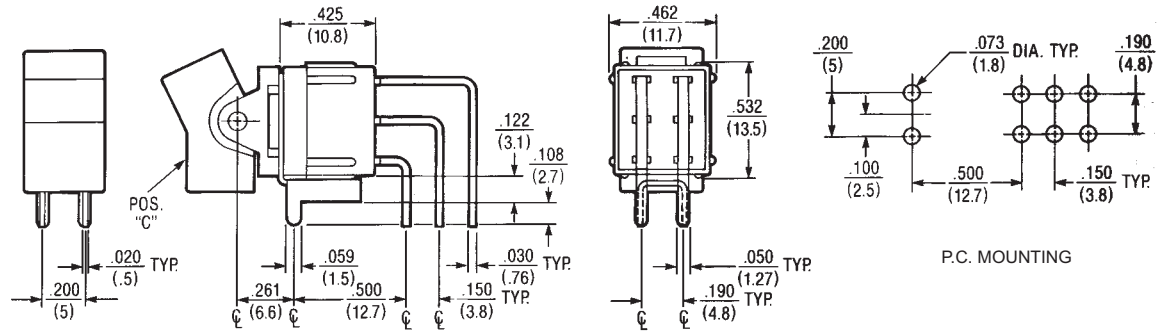

V3



ONE POLE

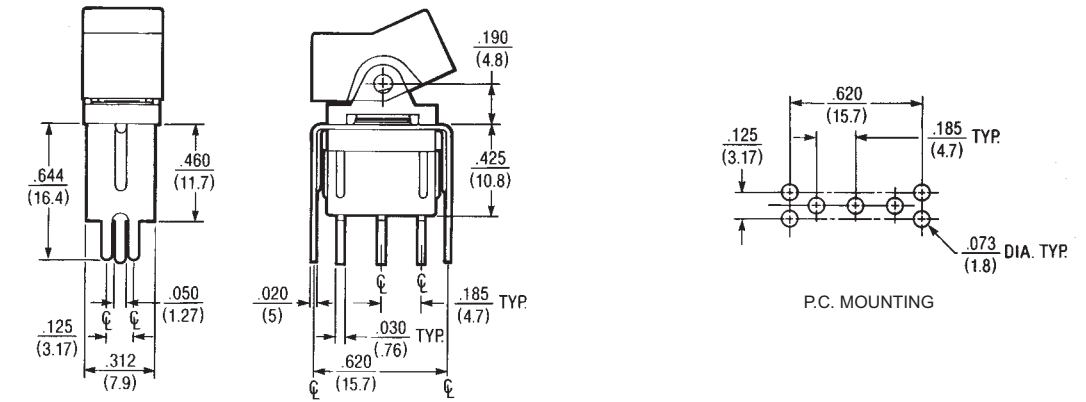

V3



TWO POLE

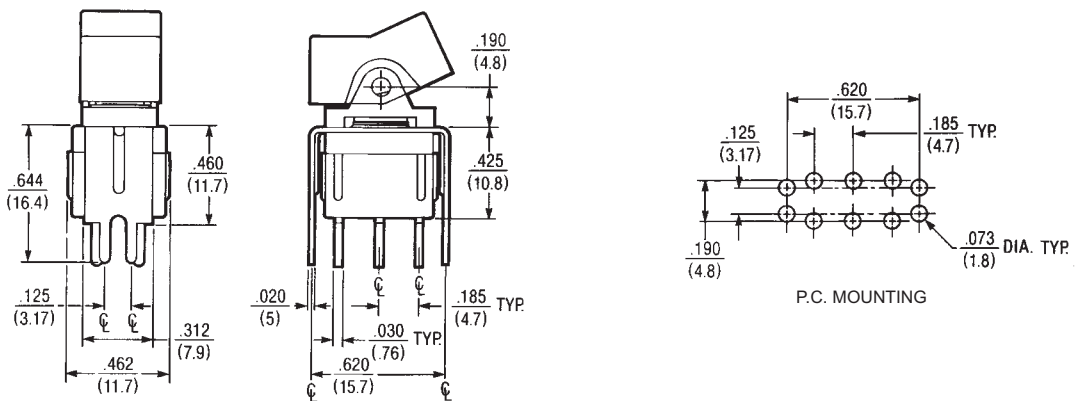

Sub-Miniature Rocker Switches for Printed Circuit Boards — Wave Solderable Series RK8000 PCB Rocker Switches

SPECIFICATIONS

- Mechanical life – 500,000 operations minimum
- Contact resistance – 25 milliohms maximum
- Dielectric strength – 1000 VAC rms
- Ambient temperature range – -20°C to +70°C
- Weight – 0.06 ounces (1.7 grams)
- Electrical life – 100,000 operations minimum
- Red rocker supplied as standard. Various rocker colors are available. For information consult Electroswitch
- Contact material – Gold over nickel over silver over copper

CURRENT RATINGS

Type	Nominal Rating, Amperes			
	6V dc	12V dc	28V dc	125V ac
RK8001-RK8007	1	1	0.5	0.5

NOTE: For special .5 VA max. rating @ 28 VAC or DC contact Electroswitch.

SELECTION TABLE

(**Bold Face Type** indicates items normally in Distributor Stock)

Circuit With Lever In			Poles & Throw	No. Of Positions	Catalog No. P.C. Terminals 0.130" (3.30 mm) Long
Position A	Position B	Position C			
ON	NONE	ON	2 Circ.	2	RK8001
ON	NONE	ON*		2	RK8002
ON*	NONE	ON		2	RK8003
ON	OFF	ON*		3	RK8004
ON*	OFF	ON		3	RK8005
ON	OFF	ON		3	RK8006
ON*	OFF	ON*	3	3	RK8007

* Momentary Contact

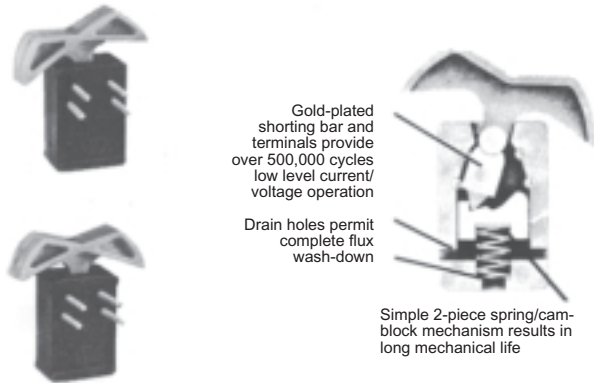

APPROXIMATE DIMENSIONS

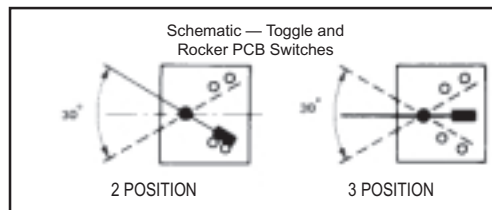
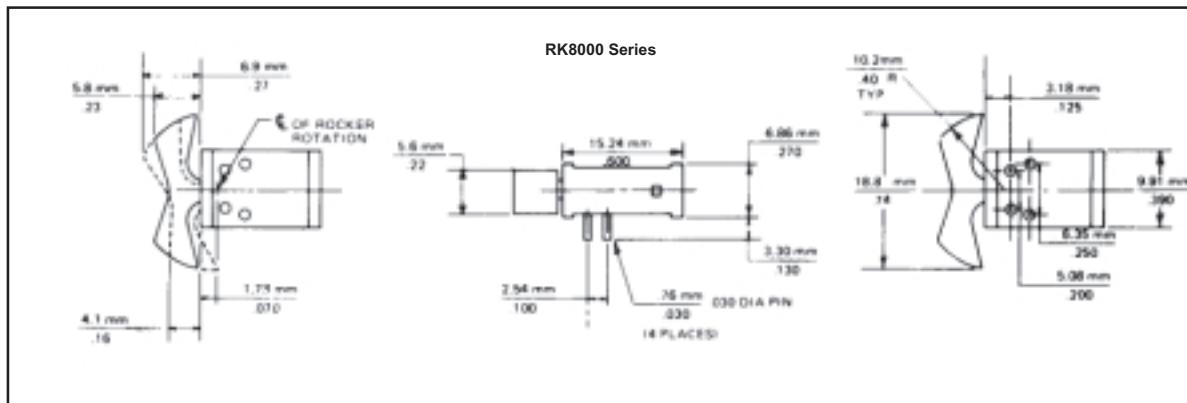

CAUTION — MANUAL SWITCHES ARE AFFECTED BY HEAT, CLEANING SOLVENTS AND FLUX. EXTREME CARE SHOULD BE EXERCISED DURING HAND SOLDERING AND WAVE SOLDERING TO PREVENT SWITCH CONTAMINATION.

Ordering Table — Standard Toggle Switches

HOW TO ORDER YOUR DESIGN (Bold Face Type indicates items normally in Distributor Stock)

Following the table from left to right, the designer is able to specify the options wanted. The options are described and illustrated on pages 24-31. Refer to page 57 for mounting hardware.

To determine a part number select the options desired and fill in the boxes in the selection guides illustrated below.

Toggle Switch Selection Guide

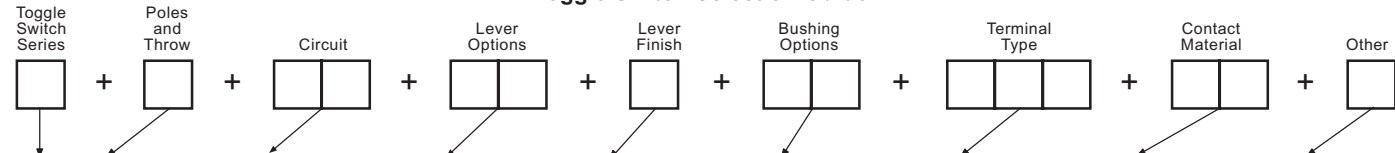

Series	Poles and Throw		Circuits ¹⁰				Lever Options and Finishes				Bushing Options		Terminal Options ⁷		Contact Material		Other Option	
	No.	Code	Keyway		Code	Type	Code	Finish	Code	Type	Code	Type	Code	Type	Code	Type	Code	
A	SPDT	1			POS. "C"	Lever Lock K Bushing Only	K1	Bright Chrome ¹⁴	1	Splashproof Lever ⁹ & Bushing Seal	CW	Right Angle PC		Gold/Nickel/Brass	B	Epoxy Sealed ⁷		
	DPDT	2	ON	OFF	ON	.840 Bat	L0	Stain Chrome	2	Splashproof ⁹	CX	Vertical PC	A	Gold/Nickel/Silver	G	Terminals		
						.640 Bat	L1	Black ¹	3	Lever Seal Only		.100 Spacing	AV	Coin Silver	Q	Anti-Rotation	P	
	3PDT	3	ON	NONE	ON	.550 Bat	L2			.280 Threaded	D	Vertical PC	AV2		K	Anti-Jam		
							L3	Black Nylon ⁸	4	²		.150 Spacing			L	Bushing ⁴		
	4PDT	4	ON	NONE	ON*	Long Mod Cap	L4	Red Nylon ⁸	5	.280 Smooth ²	D9	Printed Circuit	C		M			
						Short Mod Cap	L4	White Nylon ⁸	6	.350 Flatted	H	Terminals						
			ON*	OFF	ON*	.200 Bat	M			With Shoulder	H3	Right Angle ⁹	R					
			ON	OFF	ON*	.840 Flat	P1			.350 Keyway		Same Throw	R2					
			ON	ON	ON	.250 Flat	P3			With Shoulder	K	Right Angle ⁹						
			ON	ON	ON*	.410 Bat	P4			Locking K1	T	Opposite Throw	V30					
			ON	ON	ON*	.468 Large ¹³	S			Lever Only	TW	PC & Support	V40					
			NONE	ON	ON*	.687 Large ¹³	T1			15/32 Dia. ¹²	TX	PC & Support	V60					
			ON*	ON	ON*		T			Splashproof Lever		PC & Support	V70					
			NONE	ON	ON					¹² 15/32 & Panel Seal		PC & Support	W					
			ON*	ON	ON*					15/32 Splashproof		PC & Support	W1					
			NONE	ON	ON					¹² Lever Seal Only		PC & Support	W3					
										.350 Threaded	Y	.750 Wire Wrap	W4					
										.437 Threaded	Y5	.964 Wire Wrap	Z					
										(With P3 Only)	Y9	1.062 Wire Wrap	Z3					
										.350 Smooth		Solder Lugs						
												Quick Connect						

*Momentary Contact

- ¹ Available on S, M and P3 only.
- ² Add .070 to lever length when using these bushings.
- ³ Available with S, M, L0, L1, L2, L3, L4 lever options. Consult factory for availability.
- ⁴ Standard on P1, P3, P4 and K1 lever options. Available on all other levers except T & T1.
- ⁵ These circuits are **NOT** available with the following 3 and 4 pole options: A, AV, AV2, V30, V40, V60 and V70.
- ⁶ 1 and 2 pole only.
- ⁷ Epoxy seal standard on all terminal options.

- ⁸ Available only with L3 and L4 levers.
- ⁹ Available in 1 pole only.
- ¹⁰ See page 58 for construction detail, wiring and electrical diagrams.
- ¹¹ 1, 2 and 3 pole only.
- ¹² Available on T or T1 lever options only.
- ¹³ Available on T, TW, and TX bushing options. (Bright chrome only.)
- ¹⁴ Not available on K1 lever.
- ¹⁵ Same as B, G and Q respectively except terminals brass with tin nickel alloy over nickel plate. Consult plant for availability.

EXAMPLES:

A232L01YW1B = DPDT toggle switch with an ON-ON-ON circuit, .840" long lever in a bright chrome finish, .350 threaded bushing, .964" long wire wrap terminals, gold/brass contacts and epoxy sealed terminals.

SPECIFICATIONS:

Contact Ratings —

Letter codes G and Q — 6 amp at 125 VAC, 3 amp @ 250 VAC (U.L. recognized, CSA certified) or 6 amp at 28 VDC resistive.

Letter codes B and G — 0.5. volt-amp (VA) maximum @ 28 V maximum (AC or DC).

Life Under Load — 60,000 make-and-break cycles — resistive load only.

Initial Contact Resistance — 10 milliohms maximum 3 VDC, 100 ma for both silver and gold plated contacts.

Insulation Resistance — 1 & 2 pole —1,000 megohms, min.
3 & 4 pole —1,000 megohms, min.

Dielectric Strength — 1,000 volts rms at sea level.

Bushing Strength — 12 pound-inches without physical damage to switch.

Weight (including hardware) — SP 0.19 oz.; DP 0.23 oz.; 3-pole 0.28 oz.; 4-pole 0.32 oz.

MATERIALS:

Base (body) — 1- and 2-pole —Diallyl Phthalate (DAP).
3- and 4-pole — high strength phenolic.

Lever (toggle) — Brass, chrome plated.

Flat Lever — Brass, satin chrome finish.

Locking lever cap — Anodized aluminum.

Bushing — Brass, nickel plated.

Clamp (frame) — Stainless steel.

Support brackets — Steel, tin plated.

Switching Contacts and Rockers —

Letter Code B — gold/nickel/brass

Letter Code G — gold/nickel/silver

Letter Code Q — Coin silver

Center Terminal

Letter Codes B, G — Gold flash/nickel/brass

Letter Code Q — Silver plated brass.

Hardware — See page 55-57.

Toggle Switches — Base Dimensions and Lever Options

APPROXIMATE BASE DIMENSIONS



TOGGLE LEVER OPTIONS



Toggle Lever Options — Contd.

<p>M Short (.200")</p>	<p>P1 Flatted (.840")</p>	<p>P3 Flatted (.448")</p>	<p>P4 Flatted (.250")</p>
<p>S Std. Bat (.410")</p>	<p>T Large Toggle</p>	<p>T1 Large Toggle</p>	

BUSHING OPTIONS

<p>CW Splashproof Sealed Lever and Panel Seal</p> <p>CW = Flatted bushing</p>	<p>D D9 Threaded Smooth (No Keyway)</p>	
<p>H High Torque Flatted with Shoulder</p>	<p>H3 High Torque</p>	<p>P Anti-Rotation</p>
<p>TW Splashproof Sealed Lever and Panel Seal</p>	<p>OX Y Y9 Threaded with Lever Seal Threaded Smooth (No Keyway)</p>	<p>Y5 Long Bushing (.437")</p>

K Refer to K1 lever drawing for dimensions.

T&TX Refer to T or T1 lever drawing for dimensions.

Note: For hardware refer to pages 55-57.

<p>C Printed CIRCUIT</p>	<p>W Wire-Wrap</p>	<p>W1 Wire-Wrap</p>	<p>W3 Wire-Wrap</p>	<p>W4 Wire-Wrap</p>	<p>Z STANDARD</p>	<p>Z3 Quick CONNECT</p> <p>Mating Receptacle from AMP SPECIAL IND., P.O. Box 984, Paoli, Pa. 19301 Amp P/N single piece 61454 series, strip from 60900</p>
---------------------------------	---------------------------	----------------------------	----------------------------	----------------------------	--------------------------	-------------------------------------------------------------------------------------------------------------------------------------------------------------------

NOTE: Wire-Wrap is a registered trademark of the Gardner-Denver Company.

TERMINATION/MOUNTING OPTIONS

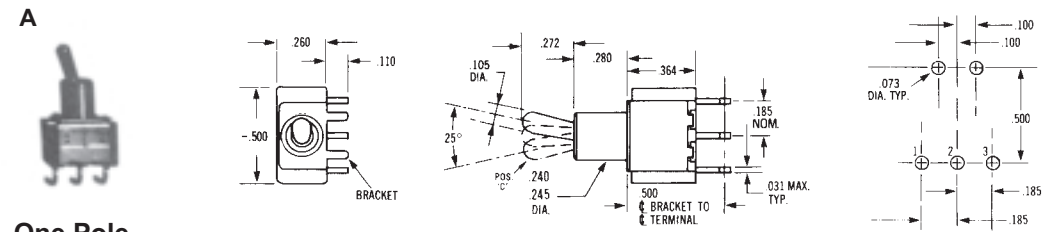

One Pole

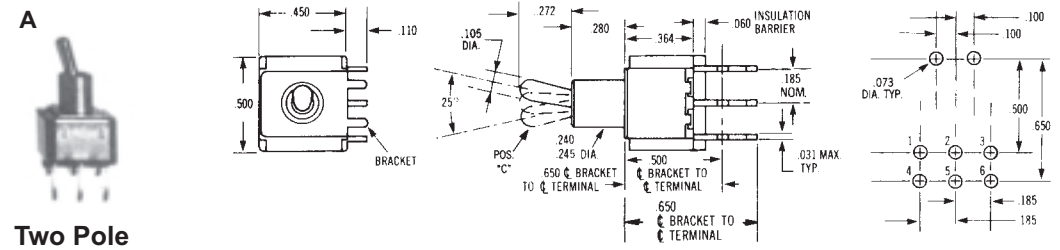

Two Pole

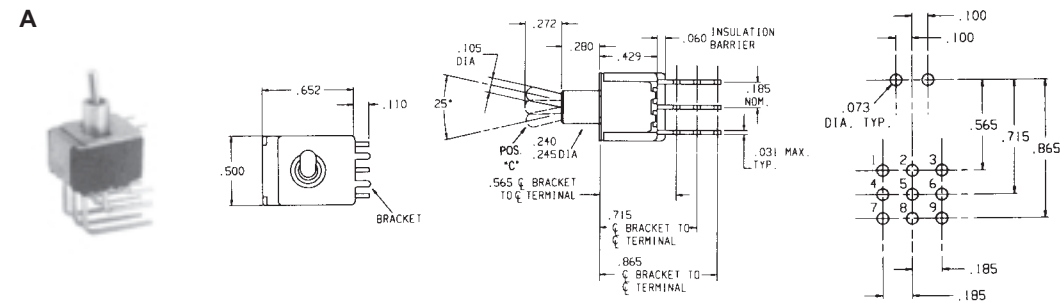
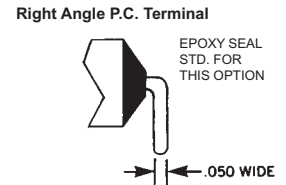

Three Pole

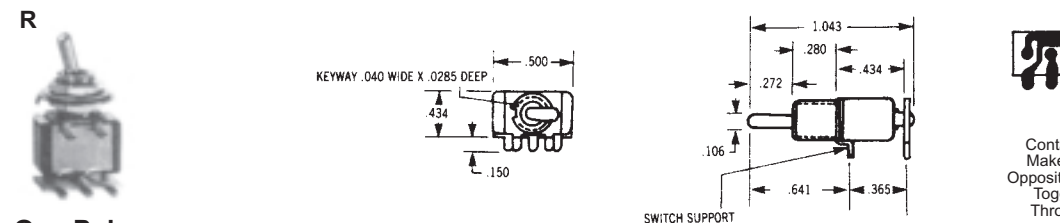

One Pole

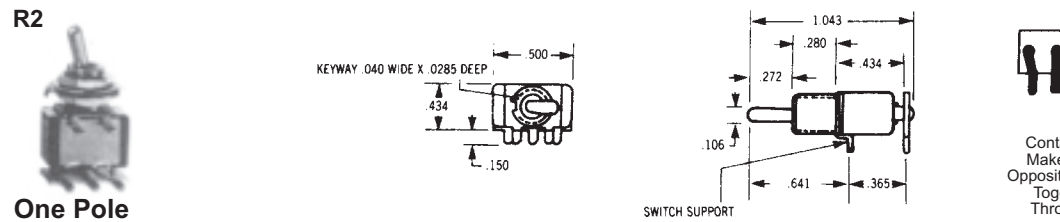

One Pole

Termination/Mounting Options

AV1	w/.100" terminal spacing
AV2	w/.150" terminal spacing (pictured below)

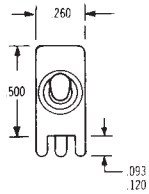

ONE POLE Epoxy sealed P.C. terminals are supplied as standard for these options.

AV1	w/.100" terminal spacing
AV2	w/.150" terminal spacing (pictured below)

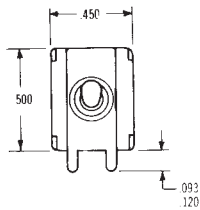

TWO POLE Epoxy sealed P.C. terminals are supplied as standard for these options.

AV	w/.100" terminal spacing
AV2	w/.150" terminal spacing (pictured below)

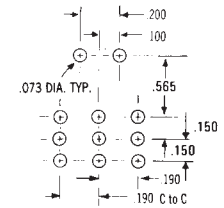
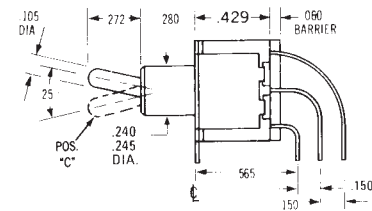
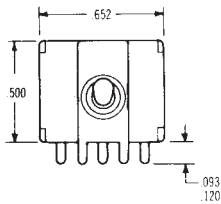

THREE POLE Epoxy sealed P.C. terminals are supplied as standard for these options.

AV	w/.100" terminal spacing
AV2	w/.150" terminal spacing (pictured below)

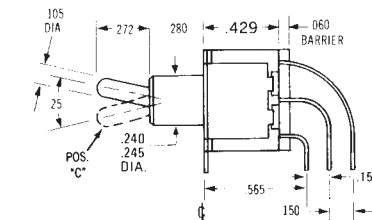
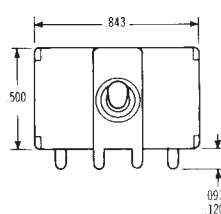

FOUR POLE Epoxy sealed P.C. terminals are supplied as standard for these options.

V30



ONE POLE



TWO POLE

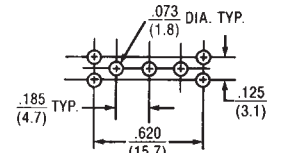
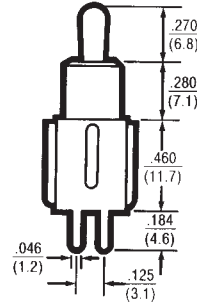
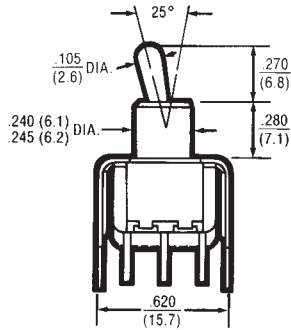
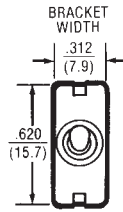

1 Pole P.C. Mounting

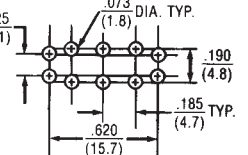

2 Pole P.C. Mounting

EPOXY SEALED P.C. TERMINALS ARE SUPPLIED AS STANDARD FOR THESE OPTIONS

V40



ONE POLE



TWO POLE

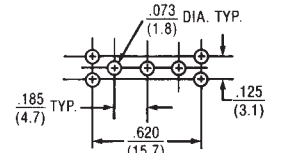
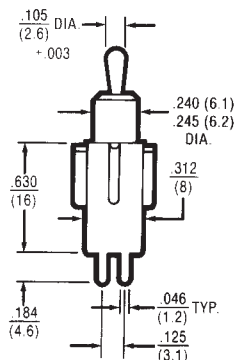
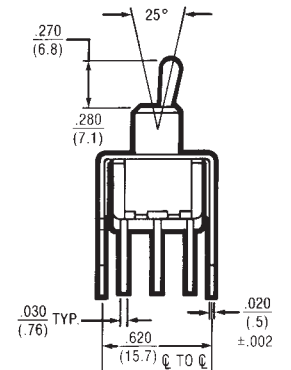
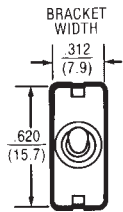

1 Pole P.C. Mounting

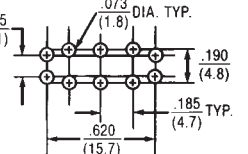

2 Pole P.C. Mounting

EPOXY SEALED P.C. TERMINALS ARE SUPPLIED AS STANDARD FOR THESE OPTIONS

V60



ONE POLE



TWO POLE

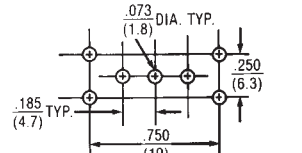
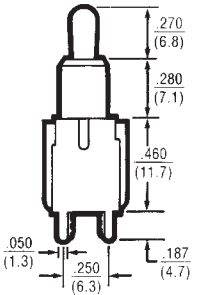
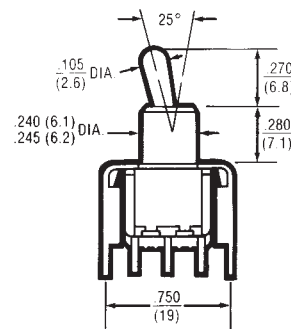
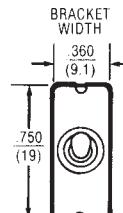

1 Pole P.C. Mounting

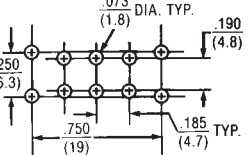

2 Pole P.C. Mounting

EPOXY SEALED P.C. TERMINALS ARE SUPPLIED AS STANDARD FOR THESE OPTIONS

V70



ONE POLE

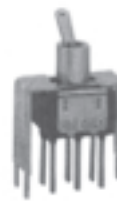

TWO POLE

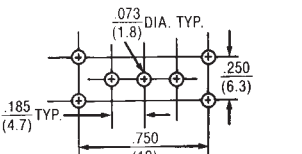
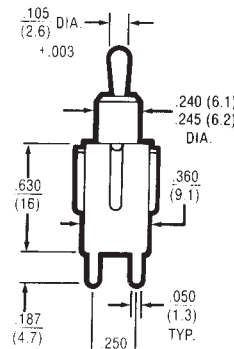
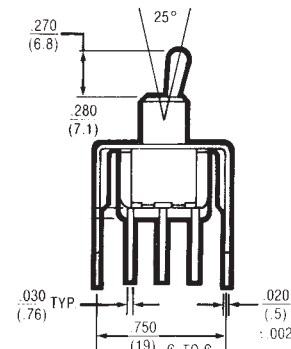
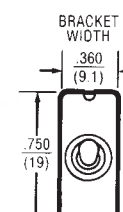

1 Pole P.C. Mounting

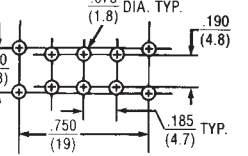

2 Pole P.C. Mounting

EPOXY SEALED P.C. TERMINALS ARE SUPPLIED AS STANDARD FOR THESE OPTIONS

Ordering Table — Washable Toggle Switches

Designed to be wave soldered along with other Printed Circuit Board Components and withstand associated cleaning processes.

HOW TO ORDER YOUR DESIGN (Bold Face Type indicates items normally in Distributor Stock)

Following the table from left to right, the designer is able to specify the options wanted. The options are described and illustrated on the following pages.

To determine a part number select the options desired and fill in the boxes in the selection guides illustrated below.

WashableToggle Switch Selection Guide

Toggle Series		Poles and Throw		Circuit			Lever Options		Lever Finish	Bushing Options		Terminal Type		Contact Material																																																																	
Series	Type	Code	No.	Code	Circuits ⑥			Type	Code	Finish	Code	Type	Code	Type	Code																																																																
Toggle	WT	SPDT	1	Keyway	ON	OFF	ON	21	.940 BAT.	L0	Bright Chrome	1	.250 Smooth	D1	Right Angle PC	A	Gold/Brass	B																																																													
																			DPDT	2	ON	NONE	ON	23	.740 BAT.	L1	Black ③	3	.280 Smooth	D9 ②	Vertical PC	AV2	Gold/Silver	G																																													
																																			ON	NONE	ON*	26	.650 BAT.	L2	Black Nylon ④	4	.350 ⑤	Threaded	Y ⑦	PC Terminals	C	Coin/Silver	Q																														
																																																		ON*	OFF	ON*	27	Long Mod Cap	L3	Red Nylon ④	5	.350 ⑤	Smooth	Y9	PC & Support	V30	W	⑧	K														
																																																																		ON	OFF	ON*	31	Short Mod Cap	L4	White Nylon ④	6	.510 BAT.	S	.750 Wire Wrap	W	⑧	L
		ON	ON	ON*	33 ①	.300 BAT.		.425 Wire Wrap	W3																																																																						
												ON*	ON	ON*	35 ①			1.062 Wire Wrap	W4																																																												
																												Solder Lug	Z																																																		
																																						Quick Connect	Z3																																								

*Momentary Contact

① 2 Pole Only.

② Subtract .030 from lever length when using this bushing.

③ Available on S and M lever options only.

④ Available only with L3 and L4 lever options only.

⑤ Subtract .100 from lever length when using these bushings.

⑥ Refer to page 59 for construction detail, wiring and electrical diagrams.

⑦ Not available on A, AV2, V30 terminal options.

⑧ Same as B, G and Q respectively except terminals brass with tin nickel alloy over nickel plate. Consult plant for availability.

EXAMPLES:

WT123M1D9AB = SPDT toggle switch with an ON-NONE-ON circuit, .270" long lever (see note 2 above) with a bright chrome finish, .280" smooth bushing right angle P.C. terminals with gold/brass contacts.

WT232S1D1V30G = DPDT toggle switch with an ON-ON-ON circuit, .510" long lever with a bright chrome finish, .250" smooth bushing, P.C. terminals with support bracket and gold/silver contacts.

SPECIFICATIONS:

Contact Ratings —

Letter codes G and Q — 6 amp at 125 VAC, 3 amp @ 250 VAC (U.L. recognized, CSA certified) or 6 amp at 28 VDC resistive.

Letter codes B and G — 0.5 volt amp (VA) maximum @ 28 V maximum (AC or DC).

Life Under Load — 60,000 make-and-break cycles — resistive load only.

Initial Contact Resistance — 10 milliohms maximum 3 VDC, 100 ma for both silver and gold plated contacts.

Insulation Resistance — 1,000 megohms, min.

Dielectric Strength — 1,000 volts rms at sea level.

Operating Temperature — -30 degrees C to 85 degrees C.

MATERIALS:

Base & Bushing — Thermoplastic high temperature (UL 94V-O).

Lever (toggle) — Brass, chrome plated.

Support brackets — Brass or steel tin plated.

Switching Contacts and Rockers —

Letter Code B — gold/nickel/brass

Letter Code G — gold/nickel/silver

Letter Code Q — Coin silver

Center Terminal

Letter Codes B and G — Gold flash/nickel/brass

Letter Code Q — Silver plated brass.

Hardware — See pages 55-57.

Washable Toggle Switches — Base Dimensions and Lever Options

APPROXIMATE BASE DIMENSIONS

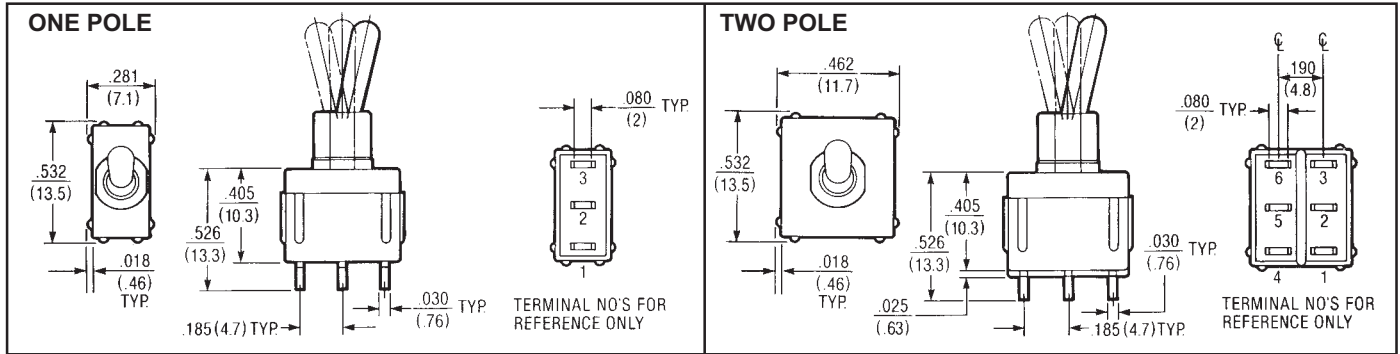

TOGGLE LEVER OPTIONS

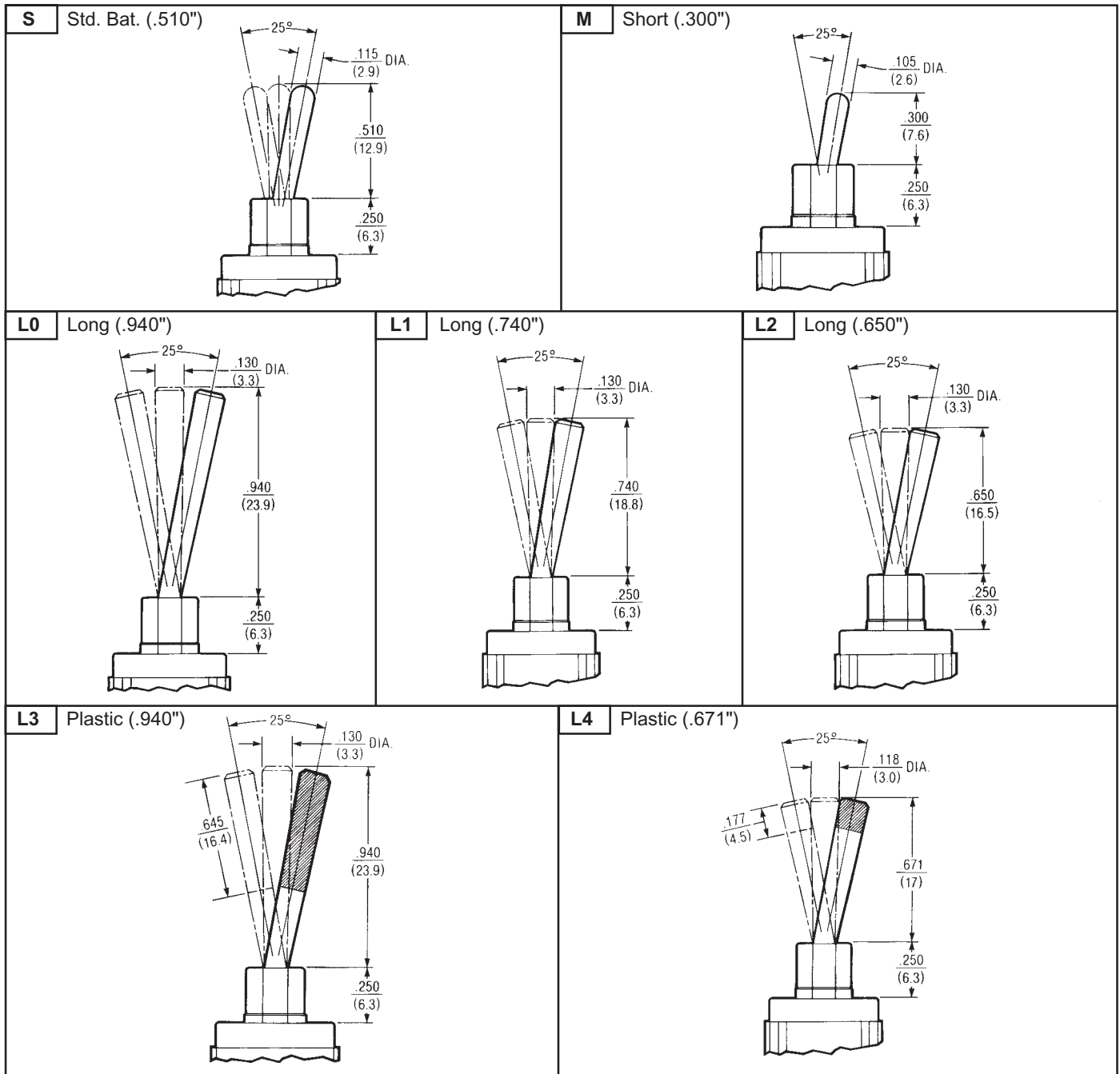

BUSHING OPTIONS

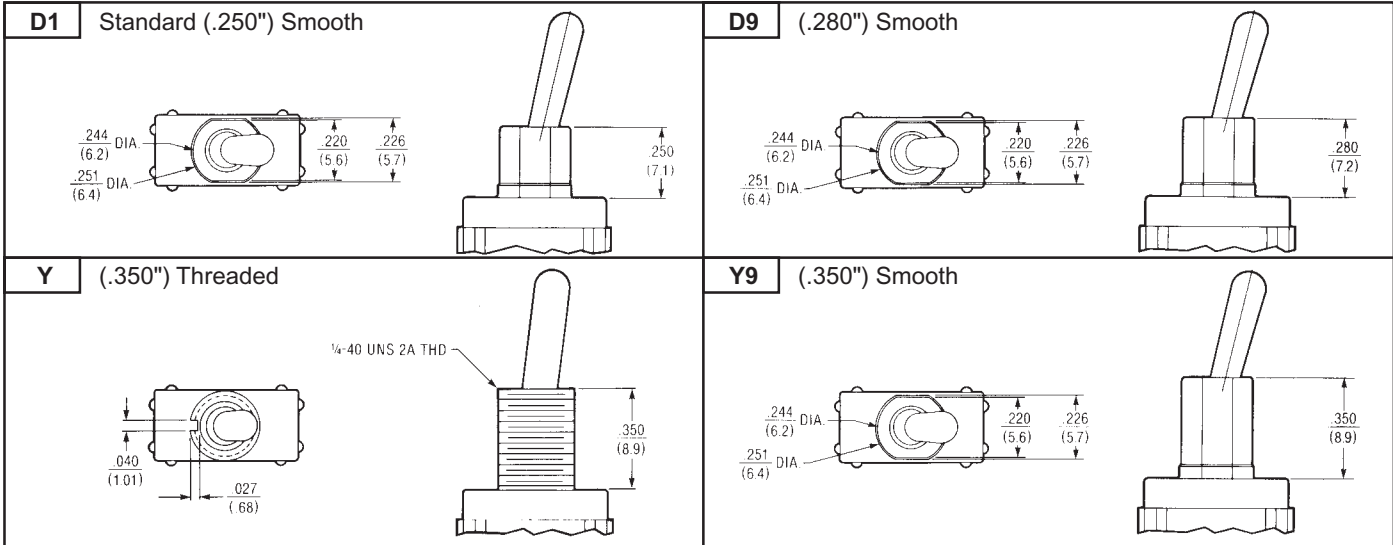

TERMINATION OPTIONS

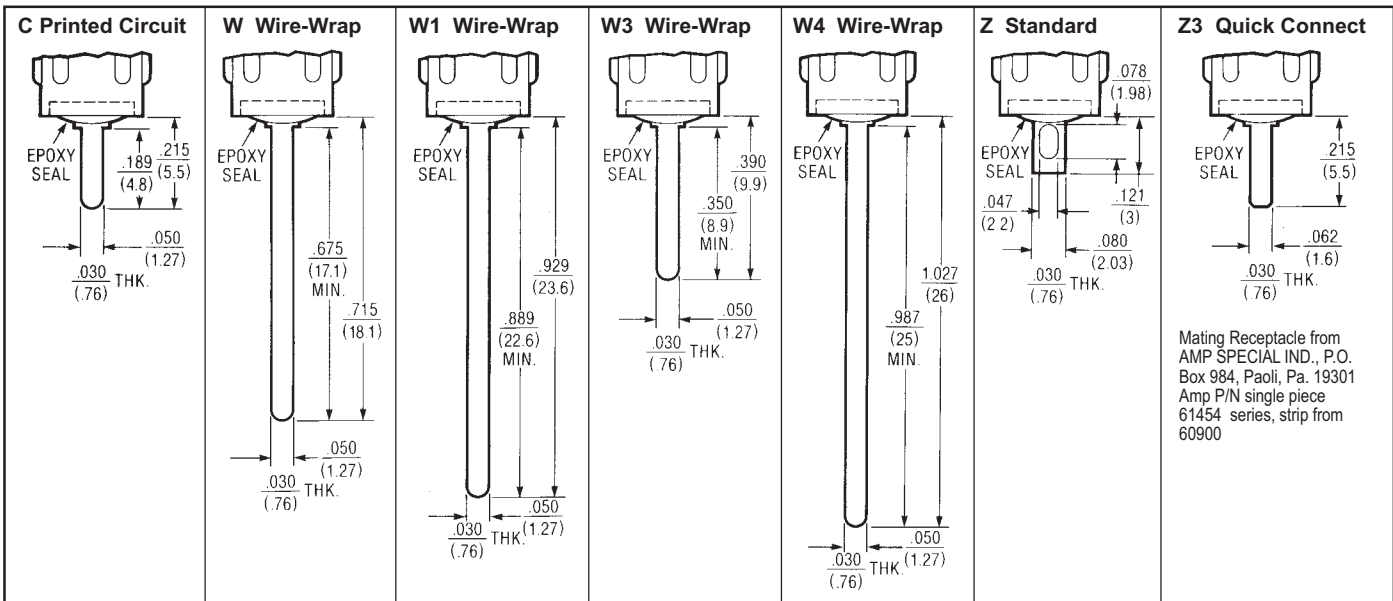

NOTE: Wire-Wrap is a registered trademark of the Gardner-Denver Company.

TERMINATION & MOUNTING OPTIONS

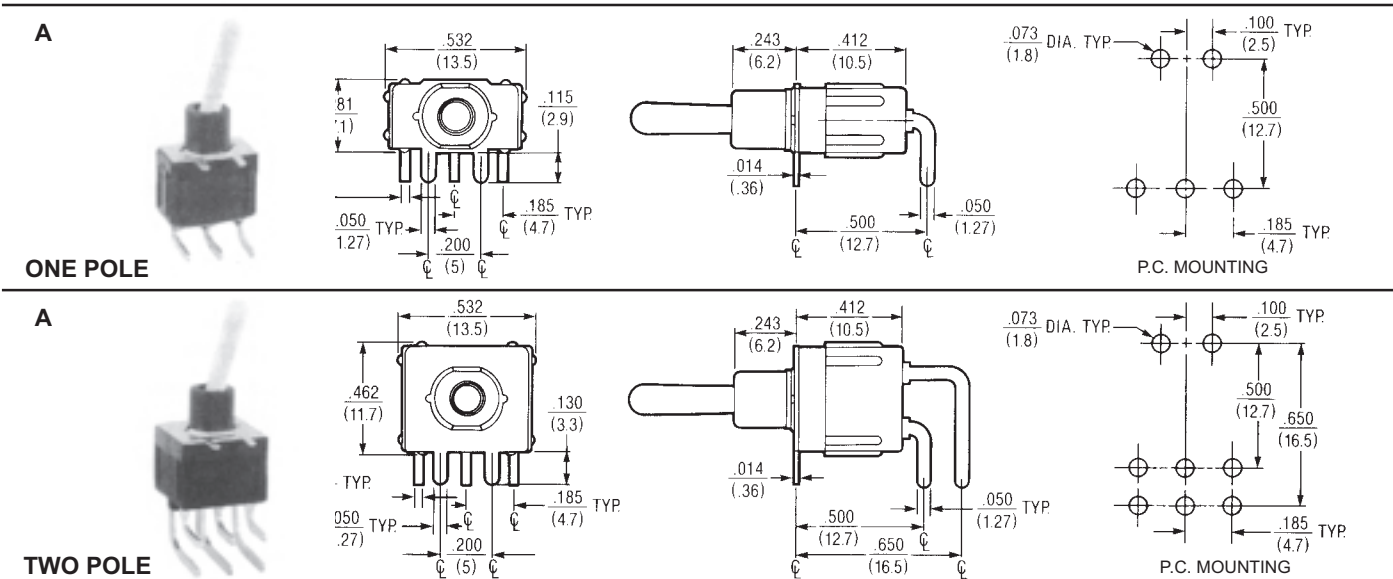

TERMINATION & MOUNTING OPTIONS — Contd.

AV2

ONE POLE

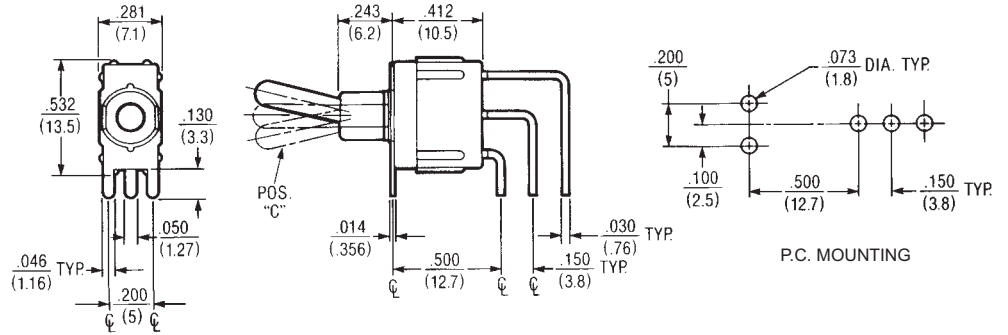

AV2

TWO POLE

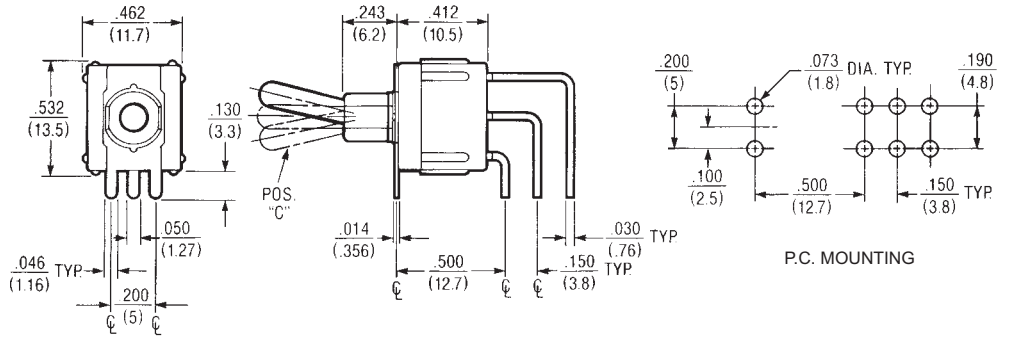

V30

ONE POLE

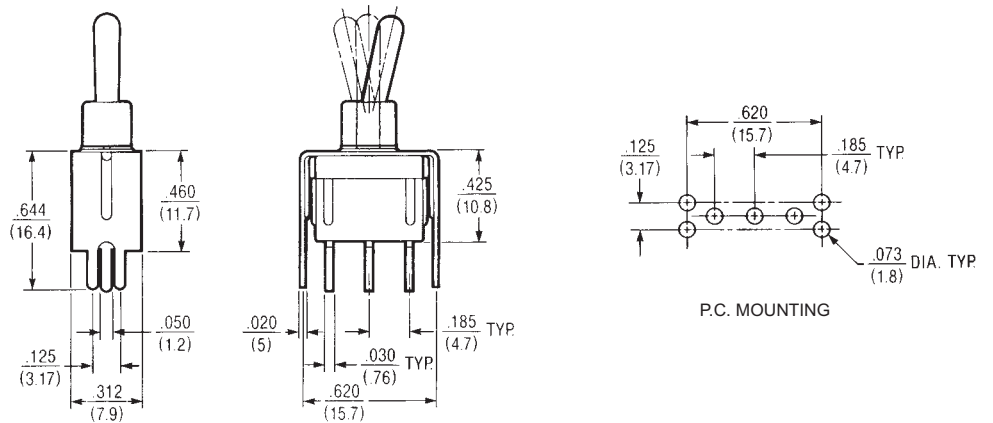

V30

TWO POLE

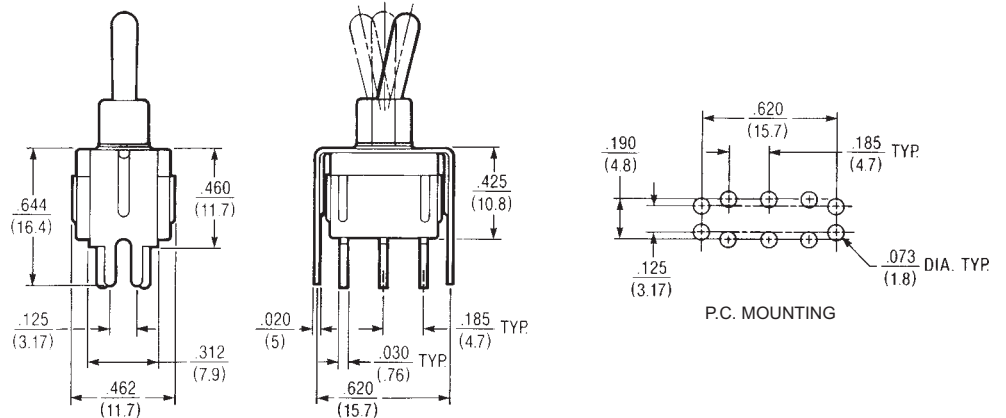
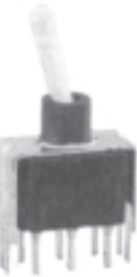

Sub-Miniature Toggle Switches for Printed Circuit Boards — Wave Solderable Series T8000 PCB Toggle Switches

SPECIFICATIONS

- Mechanical life – 500,000 operations minimum
- Contact resistance – 25 milliohms maximum
- Dielectric strength – 1000 VAC rms
- Ambient temperature range – -20°C to +70°C
- Weight – 0.06 ounces (1.7 grams)
- Electrical life – 100,000 operations minimum
- Red nylon lever supplied as standard. Various colors are available. For information consult Electros witch
- Contact material – Gold over nickel over silver over copper

CURRENT RATINGS

Type	Load	Nominal Rating, Amperes			
		6V dc	12V dc	28V dc	125V ac
T8101, T8201-T8207	Resistive	1	1	0.5	0.5

NOTE: For special .5 VA max. rating @ 28 VAC or DC contact Electros witch.

SELECTION TABLE (Bold Face Type indicates items normally in Distributor Stock)

Circuit With Lever In ①			Poles & Throw	No. Of Positions	Catalog Number By Terminal Length	
Position A	Position B	Position C			0.695" (17.65 mm)	0.130" (3.30 mm)
ON	NONE	ON	2 Circ.	2	T8101	T8201
ON	NONE	ON*		2	T8102	T8202
ON*	NONE	ON		2	T8103	T8203
ON	OFF	ON*		3	T8104	T8204
ON*	OFF	ON		3	T8105	T8205
ON	OFF	ON		3	T8106	T8206
ON*	OFF	ON*		3	T8107	T8207

* Momentary Contact

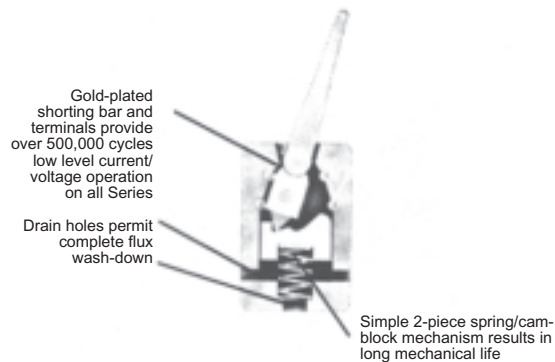

APPROXIMATE DIMENSIONS

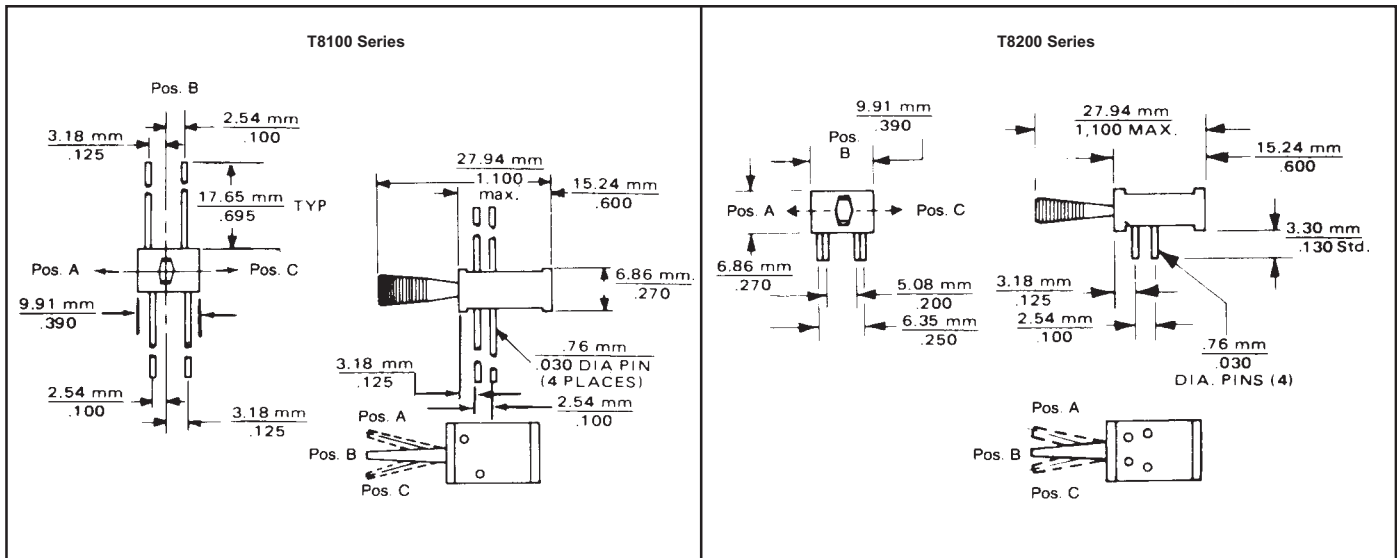

OPTIONS ②

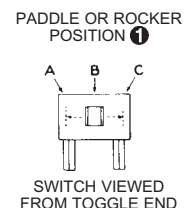
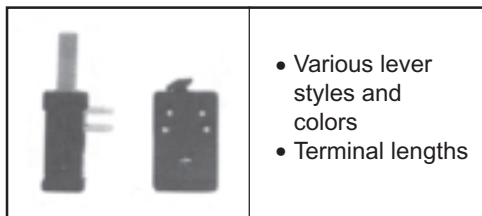
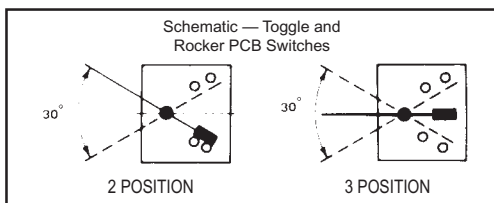

② For information on optional features consult Electros witch.

CAUTION — MANUAL SWITCHES ARE AFFECTED BY HEAT, CLEANING SOLVENTS AND FLUX. EXTREME CARE SHOULD BE EXERCISED DURING HAND SOLDERING AND WAVE SOLDERING TO PREVENT SWITCH CONTAMINATION.

Commercial Miniature Toggle Switches

SPECIFICATIONS

- Originally designed to meet the requirements of MIL-S-83731 (see page 54 for Test Specifications).
- Sealed lever type with panel seal and terminal seal.
- Flatted bushing on sealed lever type.
- Solder lug or printed circuit terminals.
- Epoxy sealed terminals.
- One and two pole circuits.
- High electrical/mechanical reliability.
- Dry circuit current carrying ability.
- Toggle lever throw 25° ±5°.

MATERIAL

- Base (body)** — Diallyl Phthalate.
- Lever** — Brass, bright chrome plated.
- Bushing** — Brass, nickel plated.
Frame — Stainless steel.
- Switching Contacts and Rockers** — 50 millionths gold over silver.
- Center Terminal** — 50 millionths gold over silver.
- Hardware** — Refer to hardware listing on page 57.



CURRENT RATINGS

Current Capacity in Amperes — Per Pole		
28 V DC	115 V AC 400 Hz	125 V AC 60 Hz
LAMP LOAD		
1	1	1
RESISTIVE LOAD		
5	5	5
INDUCTIVE LOAD		
2	2	2

LOGIC LEVEL

10 mA @ 5 V Max. (AC or DC)

SWITCH SELECTION TABLE — SEALED

	Circuit With Lever			Catalog Number	
	UP Position	CENTER Position	DOWN Position (Flat)	Solder Lug Terminals	Printed Circuit Terminals
ONE POLE					
	ON	OFF	ON	A121S1CWZG-M8	A121S1CWCG-M8
	ON	NONE	ON	A123S1CWZG-M8	A123S1CWCG-M8
	ON	NONE	ON*	A126S1CWZG-M8	A126S1CWCG-M8
	ON*	OFF	ON*	A127S1CWZG-M8	A127S1CWCG-M8
	ON	OFF	ON*	A131S1CWZG-M8	A131S1CWCG-M8
	NONE	ON	ON*	A137S1CWZG-M8	A137S1CWCG-M8
TWO POLE					
	ON	OFF	ON	A221S1CWZG-M8	A221S1CWCG-M8
	ON	NONE	ON	A223S1CWZG-M8	A223S1CWCG-M8
	ON	NONE	ON*	A226S1CWZG-M8	A226S1CWCG-M8
	ON*	OFF	ON*	A227S1CWZG-M8	A227S1CWCG-M8
	ON	OFF	ON*	A231S1CWZG-M8	A231S1CWCG-M8
	ON	ON	ON	A232S1CWZG-M8	A232S1CWCG-M8
	ON	ON	ON*	A233S1CWZG-M8	A233S1CWCG-M8
	NONE	ON	ON*	A234S1CWZG-M8	A234S1CWCG-M8
	ON*	ON	ON*	A235S1CWZG-M8	A235S1CWCG-M8

* Momentary Contact

"ON-ON-ON" CIRCUIT DIAGRAM

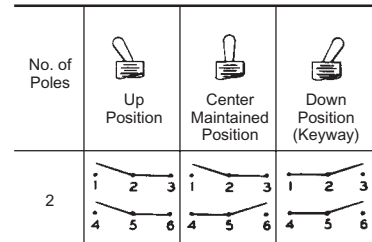

APPROXIMATE DIMENSIONS

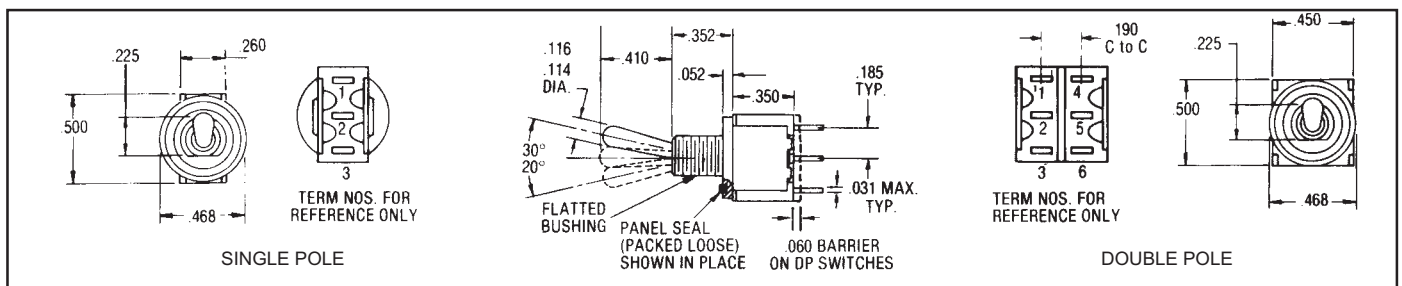

TERMINAL DIMENSIONS

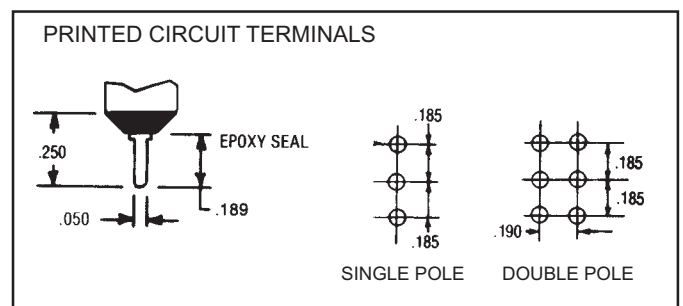
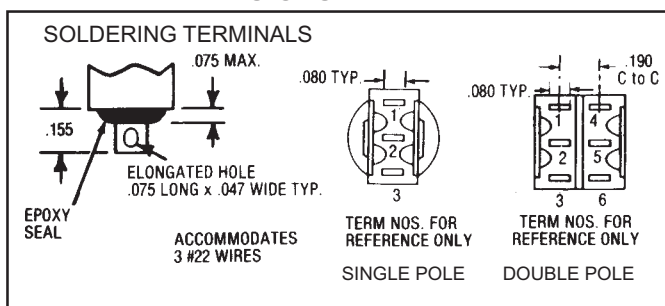

Commercial Miniature Leverlock Toggle Switches — Unsealed

SPECIFICATIONS

- One hole mounting.
- Originally designed to meet the requirements of MIL-S-83731 (see page 54 for Test Specifications).
- Slow make, slow break contact action.
- High electrical/mechanical reliability.
- Toggle lever throw $25^\circ \pm 5^\circ$.
- Solder lug or printed circuit terminals.
- One and two pole circuits.
- Dry circuit current carrying ability.
- Mounting hardware furnished unassembled

MATERIAL

- **Base (body)** — Diallyl Phthalate.
- **Locking lever** — Brass, nickel plated.
Cap — natural anodized aluminum supplied as standard; other colors such as red, blue, gold, black and green are also available.
- **Bushing** — Brass, nickel plated.
Frame — Stainless steel.
- **Switching Contacts and Rockers** — 50 millionths gold over silver.
- **Center Terminal** — 50 millionths gold over silver.
- **Hardware** — Refer to hardware listing on page 57.

CURRENT RATINGS

Current Capacity in Amperes — Per Pole		
28 V DC	115 V AC 400 Hz	125 V AC 60 Hz
LAMP LOAD		
1	1	1
RESISTIVE LOAD		
5	5	5
INDUCTIVE LOAD		
2	2	2

LOGIC LEVEL

10 mA @ 5 V Max. (AC or DC)

LEVER LOCK SELECTION TABLE

Standard Cap Style	Circuit With Lever				Catalog Number	
	UP Position	CENTER Position	DOWN Position (Keyway)	Lever Lock Bushing Style	Solder Lug Terminals	Printed Circuit Terminals
 <p>SPDT</p> <p>DPDT</p>	ONE POLE					
	ON ▶	◀ OFF ▶	◀ ON	1	A121K12KZG-M8	A121K12KCG-M8
	ON ▶	NONE	◀ ON	2	A123K12KZG-M8	A123K12KCG-M8
	ON ▶	NONE	ON*	3	A126K12KZG-M8	A126K12KCG-M8
	ON*	◀ OFF ▶	ON*	4	A127K12KZG-M8	A127K12KCG-M8
	ON ▶	◀ OFF ▶	ON*	5	A131K12KZG-M8	A131K12KCG-M8
	TWO POLE					
	ON ▶	◀ OFF ▶	◀ ON	1	A221K12KZG-M8	A221K12KCG-M8
	ON ▶	NONE	◀ ON	2	A223K12KZG-M8	A223K12KCG-M8
	ON ▶	NONE	ON*	3	A226K12KZG-M8	A226K12KCG-M8
ON*	◀ OFF ▶	ON*	4	A227K12KZG-M8	A227K12KCG-M8	
ON ▶	◀ OFF ▶	ON*	5	A231K12KZG-M8	A231K12KCG-M8	
ON ▶	◀ ON ▶	◀ ON	1	A232K12KZG-M8	A232K12KCG-M8	

* Momentary Contact
▶ Indicates direction against which lever is locked.

APPROXIMATE DIMENSIONS (For terminal dimensions see page 49)

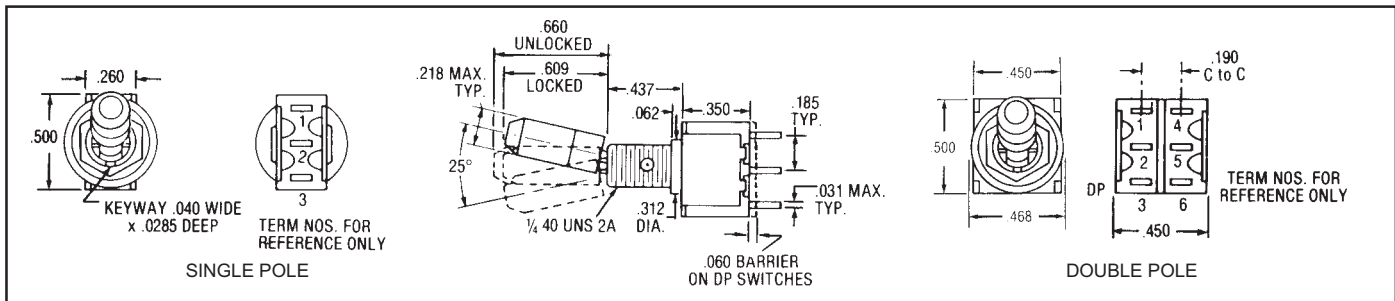

LEVER LOCK BUSHING STYLES

(The descriptive illustrations below are for pictorial representation only — keyway on right hand side)

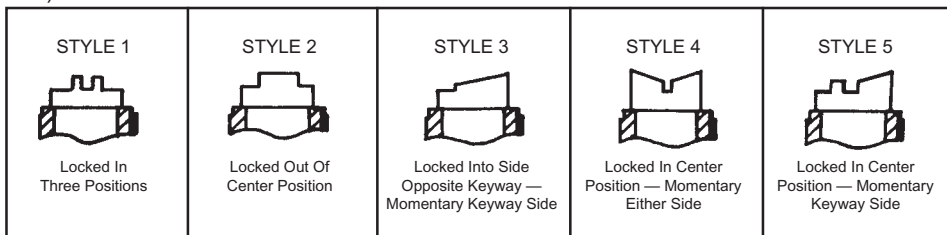

"ON-ON-ON" CIRCUIT DIAGRAM

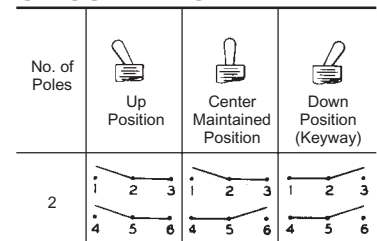

**Commercial Miniature Toggle Switches
Right Angle Mount (Vertical) P.C. Terminals**

SPECIFICATIONS

- Originally designed to meet the requirements of MIL-S-83731 (see page 54 for Test Specifications).
- Sealed lever type with panel seal and terminal seal.
- Right angle mount (vertical) printed circuit terminals.
- Epoxy sealed printed circuit terminals.
- One and two pole circuits.
- High electrical/mechanical reliability.
- Dry circuit current carrying ability.
- Toggle lever throw 25° ±5°.

MATERIAL

- **Base (body)** — Diallyl Phthalate.
- **Lever** — Brass, bright chrome plated.
- **Bushing** — Brass, nickel plated.
Frame — Stainless steel.
- **Switching Contacts and Rockers** — 50 millionths gold over silver.
- **Center Terminal** — 50 millionths gold over silver.
- **Hardware** — None required.



CURRENT RATINGS

Current Capacity in Amperes — Per Pole		
28 V DC	115 V AC 400 Hz	125 V AC 60 Hz
LAMP LOAD		
1	1	1
RESISTIVE LOAD		
5	5	5
INDUCTIVE LOAD		
2	2	2

LOGIC LEVEL

10 mA @ 5 V Max. (AC or DC)

SWITCH SELECTION TABLE — SEALED

	Circuit With Lever In...			Catalog Number
	UP Position	CENTER Position	DOWN Position (Position C)	
 SPDT	ONE POLE			
	ON	OFF	ON	A121M1D9AVG-M8
	ON	NONE	ON	A123M1D9AVG-M8
	ON	NONE	ON*	A126M1D9AVG-M8
	ON*	OFF	ON*	A127M1D9AVG-M8
	ON	OFF	ON*	A131M1D9AVG-M8
	NONE	ON	ON*	A134M1D9AVG-M8
 DPDT	TWO POLE			
	ON	OFF	ON	A221M1D9AVG-M8
	ON	NONE	ON	A223M1D9AVG-M8
	ON	NONE	ON*	A226M1D9AVG-M8
	ON*	OFF	ON*	A227M1D9AVG-M8
	ON	OFF	ON*	A231M1D9AVG-M8
	ON	ON	ON	A232M1D9AVG-M8
	ON	ON	ON*	A233M1D9AVG-M8
	NONE	ON	ON*	A234M1D9AVG-M8
	ON*	ON	ON*	A235M1D9AVG-M8

* Momentary Contact

APPROXIMATE DIMENSIONS

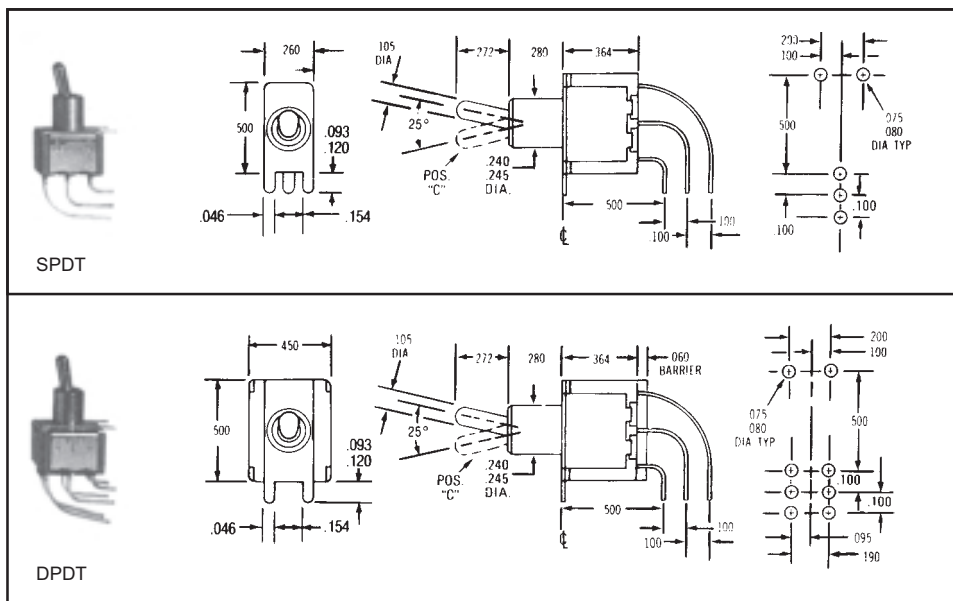

TERMINAL DIMENSIONS

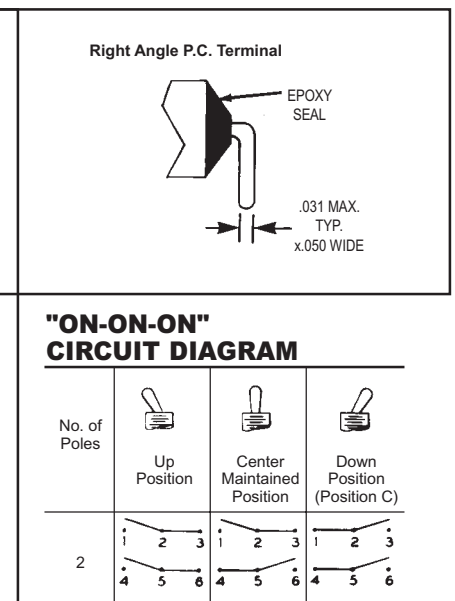

**Commercial Miniature Toggle Switches
Right Angle Mount (Horizontal) P.C. Terminals**

SPECIFICATIONS

- Originally designed to meet the requirements of MIL-S-83731 (see page 54 for Test Specifications).
- Sealed lever type with terminal seal.
- Right angle mount (horizontal) printed circuit terminals.
- Epoxy sealed printed circuit terminals.
- One and two pole circuits.
- High electrical/mechanical reliability.
- Dry circuit current carrying ability.
- Toggle lever throw $25^\circ \pm 5^\circ$.

MATERIAL

- Base (body)** — Diallyl Phthalate.
- Lever** — Brass, bright chrome plated.
- Bushing** — Brass, nickel plated.
Frame — Stainless steel.
- Switching Contacts and Rockers** — 50 millionths gold over silver.
- Center Terminal** — 50 millionths gold over silver.
- Hardware** — None required.



CURRENT RATINGS

Current Capacity in Amperes — Per Pole		
28 V DC	115 V AC 400 Hz	125 V AC 60 Hz
LAMP LOAD		
1	1	1
RESISTIVE LOAD		
5	5	5
INDUCTIVE LOAD		
2	2	2

LOGIC LEVEL

10 mA @ 5 V Max. (AC or DC)

SWITCH SELECTION TABLE — SEALED

	Circuit With Lever In...			Catalog Number
	UP Position	CENTER Position	DOWN Position (Position C)	
 SPDT	ON	OFF	ON	A121M1D9AG-M8
	ON	NONE	ON	A123M1D9AG-M8
	ON	NONE	ON*	A126M1D9AG-M8
	ON*	OFF	ON*	A127M1D9AG-M8
	ON	OFF	ON*	A131M1D9AG-M8
	NONE	ON	ON*	A134M1D9AG-M8
 DPDT	ON	OFF	ON	A221M1D9AG-M8
	ON	NONE	ON	A223M1D9AG-M8
	ON	NONE	ON*	A226M1D9AG-M8
	ON*	OFF	ON*	A227M1D9AG-M8
	ON	OFF	ON*	A231M1D9AG-M8
	ON	ON	ON	A232M1D9AG-M8
	ON	ON	ON*	A233M1D9AG-M8
	NONE	ON	ON*	A234M1D9AG-M8
	ON*	ON	ON*	A235M1D9AG-M8

* Momentary Contact

APPROXIMATE DIMENSIONS

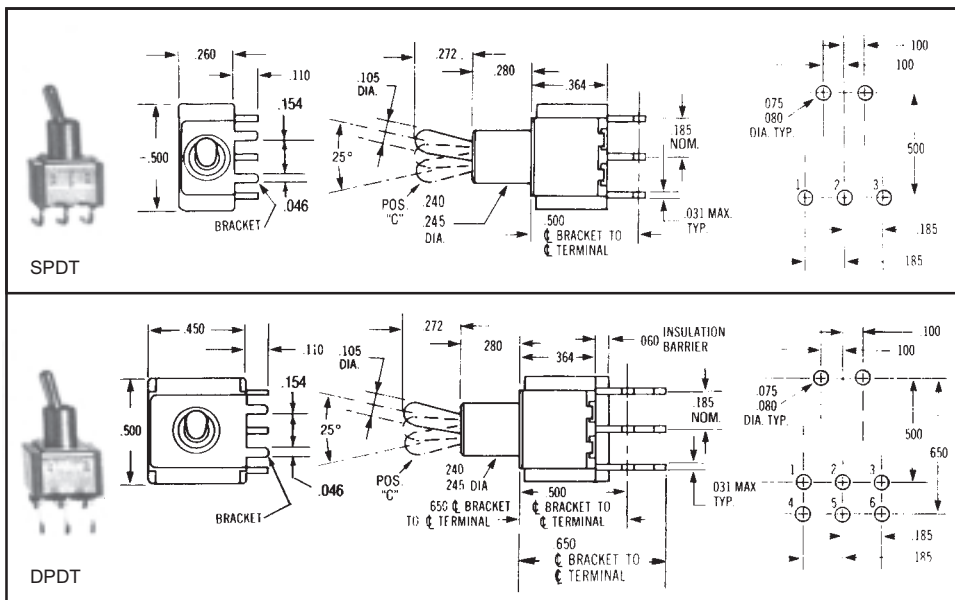

TERMINAL DIMENSIONS

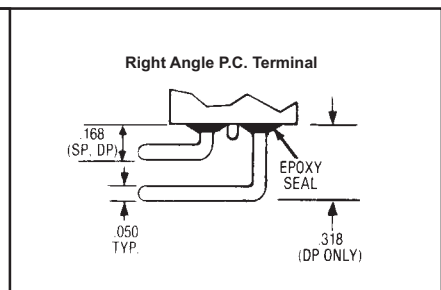

"ON-ON-ON" CIRCUIT DIAGRAM

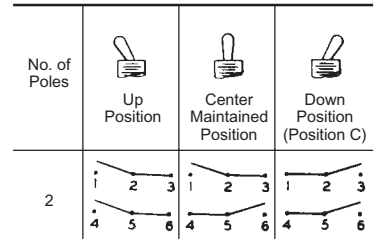

Commercial Miniature Toggle Switches – New Four Pole

SPECIFICATIONS

- Originally designed to meet the requirements of MIL-S-83731 (see page 54 for Test Specifications).
- Sealed lever type with panel seal and terminal seal.
- Flatted bushing on sealed lever type.
- Solder lug or printed circuit terminals.
- Epoxy sealed terminals.
- One and two pole circuits.
- High electrical/mechanical reliability.
- Dry circuit current carrying ability.
- Toggle lever throw 25° ±5°.

MATERIAL

- **Base (body)** — Diallyl Phthalate.
- **Lever** — Brass, bright chrome plated.
- **Locking Lever** — Brass, nickel plated.
Cap — natural anodized aluminum supplied as standard; other colors such as red, blue, gold, black and green are also available.
- **Bushing** — Brass, nickel plated.
Frame — Stainless steel.
- **Switching Contacts and Rockers** — 50 millionths gold over silver.
- **Center Terminal** — 50 millionths gold over silver.
- **Hardware** — Refer to hardware listing on page 57.

CURRENT RATINGS

Current Capacity in Amperes — Per Pole		
28 V DC	115 V AC 400 Hz	125 V AC 60 Hz
LAMP LOAD		
1	1	1
RESISTIVE LOAD		
5	5	5
INDUCTIVE LOAD		
2	2	2

LOGIC LEVEL

10 mA @ 5 V Max. (AC or DC)

SWITCH SELECTION TABLE — SEALED

	Circuit With Lever In...			Catalog Number	
	UP Position	CENTER Position	DOWN Position (Flat)	Solder Lug Terminals	Printed Circuit Terminals
 4-PDT	ON	OFF	ON	A421S1CWZG-M8	A421S1CWCG-M8
	ON	NONE	ON	A423S1CWZG-M8	A423S1CWCG-M8
	ON	NONE	ON*	A426S1CWZG-M8	A426S1CWCG-M8
	ON*	OFF	ON*	A427S1CWZG-M8	A427S1CWCG-M8
	ON	OFF	ON*	A431S1CWZG-M8	A431S1CWCG-M8
	ON	ON	ON	A432S1CWZG-M8	A432S1CWCG-M8
	ON	ON	ON*	A433S1CWZG-M8	A433S1CWCG-M8
	NONE	ON	ON*	A434S1CWZG-M8	A434S1CWCG-M8
	ON*	ON	ON*	A435S1CWZG-M8	A435S1CWCG-M8

* Momentary Contact

LEVER LOCK SELECTION TABLE — UNSEALED

Standard Cap Style	Circuit With Lever In...			Lever Lock Bushing Style	Catalog Number	
	UP Position	CENTER Position	DOWN Position (Keyway)		Solder Lug Terminals	Printed Circuit Terminals
 FOUR POLE	ON ▶	◀ OFF ▶	◀ ON	1	A421K12KZG-M8	A421K12KCG-M8
	ON ▶	NONE	◀ ON	2	A423K12KZG-M8	A423K12KCG-M8
	ON ▶	NONE	ON*	3	A426K12KZG-M8	A426K12KCG-M8
	ON*	◀ OFF ▶	ON*	4	A427K12KZG-M8	A427K12KCG-M8
	ON ▶	◀ OFF ▶	ON*	5	A431K12KZG-M8	A431K12KCG-M8
	ON ▶	◀ ON ▶	◀ ON	1	A432K12KZG-M8	A432K12KCG-M8

* Momentary Contact

▶ Indicates direction against which lever is locked.

APPROXIMATE DIMENSIONS

(For terminal dimensions see page 49)

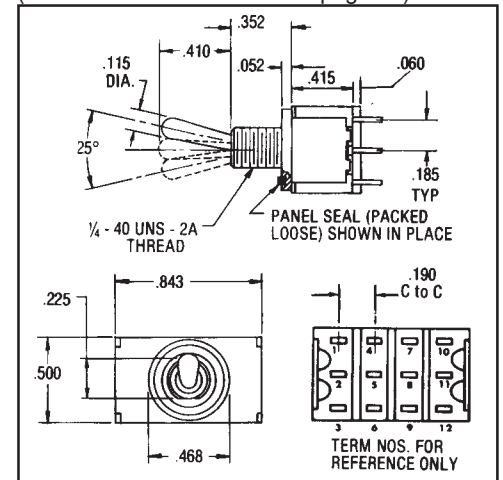

APPROXIMATE DIMENSIONS (For terminal dimensions see page 49)

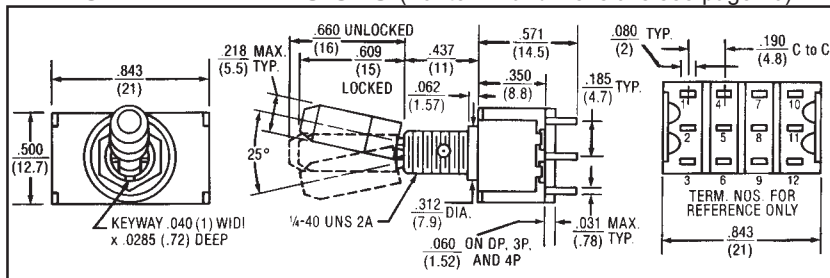

"ON-ON-ON"

CIRCUIT DIAGRAM

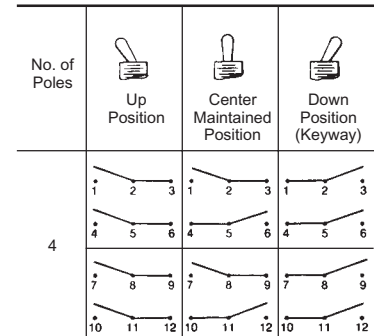

NOTE: FOR LEVER LOCK BUSHING STYLES SEE PAGE 50.

Rating, Cross Reference and Engineering Data
**“A” Series Originally Designed To Meet
the Following MIL Specifications**

Test Requirement	MIL Specification
1. Strength of Terminal	1 lb. — solder lug
2. Strength of Actuating Lever Pivot and Stop	10 lbs. & 8 lbs. throughout range
3. Strength of Mounting Means	15 lbs. in. torque on bushing
4. Dielectric (Sea Level) Indication Dielectric (Altitude)	1000 VAC Group C 750 VAC after electrical endurance. 500 μ A max. leakage
5. Contact Voltage Drop	2.5 millivolt initial 5.0 millivolt after mechanical endurance @ 2-6 VDC 0.1 amp.
6. Temperature Rise	50°C rise @ rated resistance after endurance test current
7. Short Circuit	10 operations make and carry 100 amps resistive load @ lowest DC volts
8. Mechanical Life	20K operations at specified high and low temperatures
9. Electrical Endurance	10K operations at specified high and low temperatures
10. Overload	50 operations @ 150% of rated resistive load
11. A) Electrical Endurance at Altitude	No requirement
B) Electrical Endurance at Sea Level	10K operations resistive load @ room temperature 10K operations inductive load @ room temperature 10K operations lamp load @ room temperature Performed on different test samples
12. Vibration	Method 204 of MIL-STD-202, test condition A .06 D.A. or 10 G's 10-500 Hz 10 usec. max. chatter
13. Shock	Fuse-method 213 or MIL-STD @75 G's 10 usec. max, chatter
14. Salt Spray Test Upon Completion	48 hours — method 101 of MIL-STD-202, test condition B 10 operations resistive load (toggle sealed switches only)
15. Moisture Resistance Test Upon Completion	Method 106 of MIL-STD-202 100 VDC potential between current carrying parts and panel
16. Sand & Dust	Method 110 of MIL-STD-202, test condition B 6 hours @ 23°C 2.5K operations mechanical life (toggle sealed switches only)
17. Explosion	MIL-STD-202 method 109, maximum rated DC inductive load (toggle sealed switches only)
18. Sealing	Toggle seal — 5 operations under 0.5 inches of H ₂ O above top of bushing
19. A) Toggle Seal B) Bushing Seal	No requirement
20. Temperature Operation	Mechanical life, -25°C to +71°C
21. Life Low Cur. Level	No requirement
22. Fungus	No requirement
23. Intermediate Current	10K operations, 50 milliamps @ 10 VDC resistive load @ 20,000 feet altitude @ room temperature
24. Thermal Shock	Method 107 of MIL-STD-202 test condition A 5 cycles @ -55°C/+85°C

Construction Detail Wiring and Electrical Diagrams for Standard Miniature Switches

CONSTRUCTION DETAIL

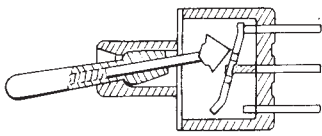

2 POSITION on-none-on

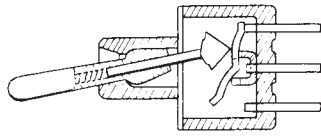

3 POSITION on-off-on

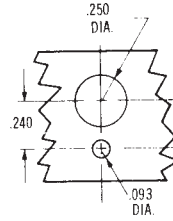

For 1/4" Bushing and Standard Locking Ring

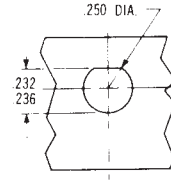

For 1/4" Flatted Bushing

WIRING FOR 3 POSITION CONVERSION

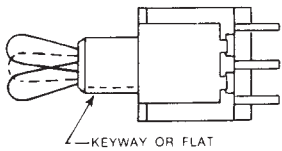

KEYWAY OR FLAT

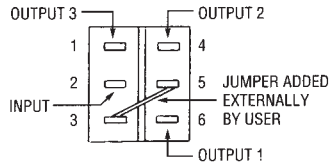

Single Pole Using Double Pole Switch
(For 232, 233 and 235 Circuits)

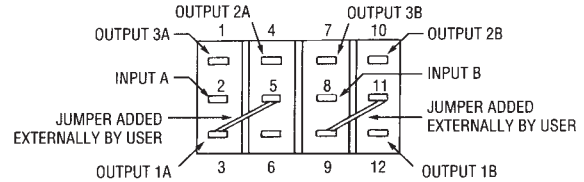

Double Pole Using Four Pole Switch
(For 432, 433 and 435 Circuits)

TOGGLE UP	Output 1	Output 1A, 1B
TOGGLE CENTER	Output 2	Output 2A, 2B
TOGGLE DOWN (Keyway or Flat)	Output 3	Output 3A, 3B

ELECTRICAL DIAGRAMS

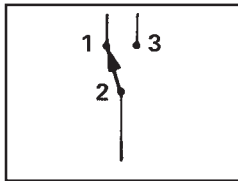

SP

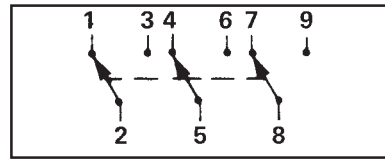

3-P

ALL EXCEPT 232, 233, 235 **Note A**

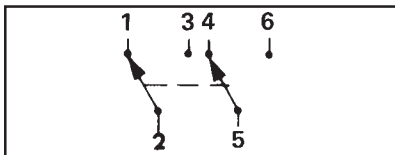

DP

ALL EXCEPT 432, 433, 435 **Note B**

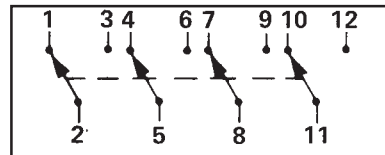

3-P

NOTES

NOTE A: Circuitry	LEVER LEFT	CENTER	RIGHT (KEYWAY)	NOTE B: Circuitry	LEVER LEFT	CENTER	RIGHT (KEYWAY)
232	On 2-3 5-6	On 2-3 4-5	On 1-2 4-5	432	On 2-3-8-9 5-6-11-12	On 2-3-8-9 4-5-10-11	On 1-2-7-8 4-5-10-11
233	On 2-3 5-6	On 2-3 4-5	On* 1-2 4-5	433	On 2-3-8-9 5-6-11-12	On 2-3-8-9 4-5-10-11	On* 1-2-7-8 4-5-10-11
235	On* 2-3 5-6	On 2-3 4-5	On* 1-2 4-5	435	On* 2-3-8-9 5-6-11-12	On 2-3-8-9 4-5-10-11	On* 1-2-7-8 4-5-10-11

Other configurations available on special order.

Circuit Diagrams for Washable Miniature Switches

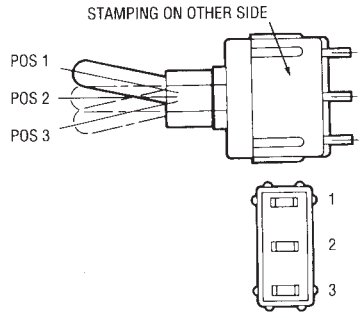
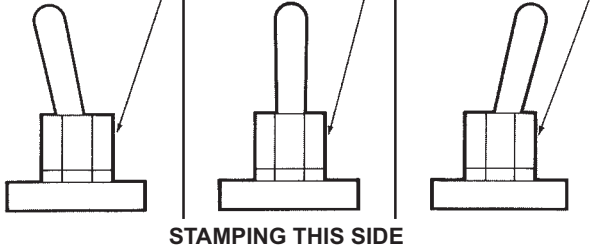
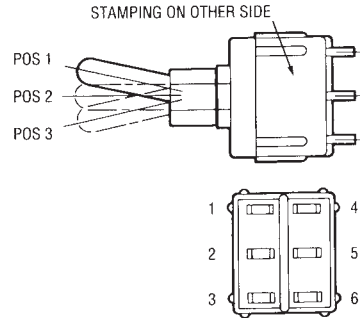
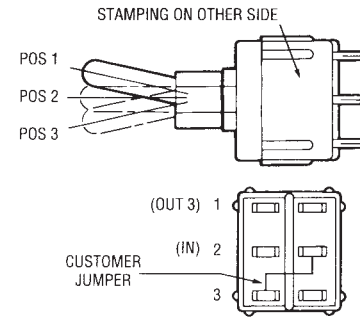
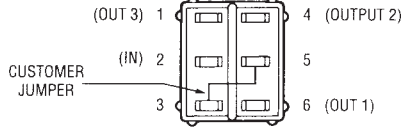
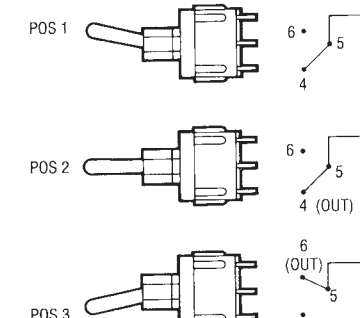
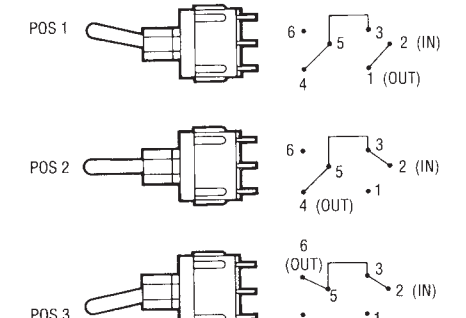
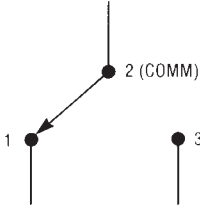
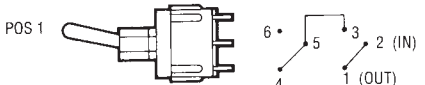
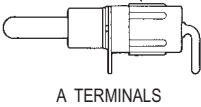
CIRCUIT CODE	SWITCHING FUNCTION			Single Pole STAMPING ON OTHER SIDE 
	POS 1	POS 2	POS 3	
	KEYWAY "Y" OPTION 			
SINGLE POLE				Double Pole STAMPING ON OTHER SIDE 
121	ON	OFF	ON	
123	ON	NONE	ON	
126	ON	NONE	MOM	
127	MOM	OFF	MOM	
131	ON	OFF	MOM	
TERMINAL CONNECTIONS	2 - 3	OPEN	2 - 1	
DOUBLE POLE				SP3T STAMPING ON OTHER SIDE 
221	ON	OFF	ON	
223	ON	NONE	ON	
226	ON	NONE	MOM	
227	MOM	OFF	MOM	
231	ON	OFF	MOM	
TERMINAL CONNECTIONS	2 - 3 5 - 6	OPEN	2 - 1 5 - 4	
SP3T				
232	ON	ON	ON	
233	ON	ON	MOM	
235	MOM	ON	MOM	
TERMINAL CONNECTIONS	2 - 3 5 - 6	2 - 3 5 - 4	2 - 1 5 - 4	
Schematics:				
<div style="display: flex; justify-content: space-around;"> <div style="text-align: center;"> <p>S.P.</p>  </div> <div style="text-align: center;"> <p>D.P.</p>  </div> </div>				
<p>STAMPING ON TOP</p>  <p>A TERMINALS</p>		<p>STAMPING ON OPPOSITE SIDE</p>  <p>AV2 TERMINALS</p>		

CrossReference
FORMER EATON (JBT) PART NUMBER TO ELECTROSWITCH PART NUMBER*

Former Eaton Part No.	Electroswitch Part No.	Former Eaton Part No.	Electroswitch Part No.	Former Eaton Part No.	Electroswitch Part No.	Former Eaton Part No.	Electroswitch Part No.
FH-121	A121P32YZQ	LFH-227	A227P32Y5ZQ	MP2-235	B235J21ZQ22M	MP7-127	B127J60ZQ2
123	A123P32YZQ	231	A231P32Y5ZQ	321	B321J21ZQ22M	131	B131J60ZQ2
126	A126P32YZQ	232	A232P32Y5ZQ	323	B323J21ZQ22M	221	B221J60ZQ2
127	A127P32YZQ	233	A233P32Y5ZQ	327	B327J21ZQ22M	223	B223J60ZQ2
131	A131P32YZQ	234	A234P32Y5ZQ	331	B331J21ZQ22M	226	B226J60ZQ2
FH-134	A134P32YZQ	LFH-235	A235P32Y5ZQ	MP2-421	B421J21ZQ22M	MP7-227	B237J60ZQ2
221	A221P32YZQ	321	A321P32Y5ZQ	423	B423J21ZQ22M	231	B231J60ZQ2
223	A223P32YZQ	323	A323P32Y5ZQ	427	B427J21ZQ22M	232	B232J60ZQ2
226	A226P32YZQ	327	A327P32Y5ZQ	431	B431J21ZQ22M	233	B233J60ZQ2
227	A227P32YZQ	331	A331P32Y5ZQ	432	B432J21ZQ22M	235	B235J60ZQ2
FH-231	A231P32YZQ	LFH-334	A334P32Y5ZQ	MP2-433	B433J21ZQ22M	MPC-121	A121S1YQ
232	A232P32YZQ	421	A421P32Y5ZQ	435	B435J21ZQ22M	123	A123S1YQ
233	A233P32YZQ	423	A423P32Y5ZQ	MP4-121	B121J5ZQ2	126	A126S1YQ
234	A234P32YZQ	427	A427P32Y5ZQ	123	B123J5ZQ2	127	A127S1YQ
235	A235P32YZQ	431	A431P32Y5ZQ	126	B126J5ZQ2	131	A131S1YQ
FH-321	A321P32YZQ	LFH-432	A432P32Y5ZQ	MP4-127	B127J5ZQ2	MPC-134	A134S1YQ
323	A323P32YZQ	433	A433P32Y5ZQ	131	B131J5ZQ2	221	A221S1YQ
327	A327P32YZQ	434	A434P32Y5ZQ	221	B221J5ZQ2	223	A223S1YQ
331	A331P32YZQ	435	A435P32Y5ZQ	223	B223J5ZQ2	226	A226S1YQ
334	A334P32YZQ	LL-121	A121K12KZQ	226	B226J5ZQ2	227	A227S1YQ
FH-421	A421P32YZQ	LL-123	A123K12KZQ	MP4-227	B227J5ZQ2	MPC-231	A231S1YQ
423	A423P32YZQ	221	A221K12KZQ	231	B231J5ZQ2	232	A232S1YQ
427	A427P32YZQ	223	A223K12KZQ	232	B232J5ZQ2	233	A233S1YQ
431	A431P32YZQ	232	A232K12KZQ	233	B233J5ZQ2	234	A234S1YQ
432	A432P32YZQ	321	A321K12KZQ	235	B235J5ZQ2	235	A235S1YQ
FH-433	A433P32YZQ	LL-323	A323K12KZQ	MP4-321	B321J5ZQ2	MPC-321	A321S1YQ
434	A434P32YZQ	421	A421K12KZQ	323	B323J5ZQ2	323	A323S1YQ
435	A435P32YZQ	423	A423K12KZQ	327	B327J5ZQ2	327	A327S1YQ
JMT-121	A121S1YZQ	432	A432K12KZQ	331	B331J5ZQ2	331	A331S1YQ
123	A123S1YZQ	MP1-121	B121J2ZQ2	421	B421J5ZQ2	334	A334S1YQ
JMT-126	A126S1YZQ	MP1-123	B123J2ZQ2	MP4-423	B423J5ZQ2	MPC-421	A421S1YQ
127	A127S1YZQ	126	B126J2ZQ2	427	B427J5ZQ2	423	A423S1YQ
131	A131S1YZQ	127	B127J2ZQ2	431	B431J5ZQ2	427	A427S1YQ
134	A134S1YZQ	131	B131J2ZQ2	432	B432J5ZQ2	431	A431S1YQ
221	A221S1YZQ	221	B221J2ZQ2	433	B433J5ZQ2	432	A432S1YQ
JMT-223	A223S1YZQ	MP1-223	B223J2ZQ2	MP4-435	B435J5ZQ2	MPC-433	A433S1YQ
226	A226S1YZQ	226	B226J2ZQ2	MPS-121	B121J72V3B2	434	A434S1YQ
227	A227S1YZQ	227	B227J2ZQ2	123	B123J72V3B2	435	A435S1YQ
231	A231S1YZQ	231	B231J2ZQ2	126	B126J72V3B2	MR1-121	B121J1ZQ2
232	A232S1YZQ	232	B232J2ZQ2	127	B127J72V3B2	123	B123J1ZQ2
JMT-233	A233S1YZQ	MP1-233	B233J2ZQ2	MP5-131	B131J72V3B2	MB1-126	B126J1ZQ2
234	A234S1YZQ	235	B235J2ZQ2	221	B221J72V3B2	127	B127J1ZQ2
235	A235S1YZQ	321	B321J2ZQ2	223	B223J72V3B2	131	B131J1ZQ2
321	A321S1YZQ	323	B323J2ZQ2	226	B226J72V3B2	221	B221J1ZQ2
323	A323S1YZQ	327	B327J2ZQ2	227	B227J72V3B2	223	B223J1ZQ2
JMT-327	A327S1YZQ	MP1-331	B331J2ZQ2	MF5-231	B231J72V3B2	MR1-226	B226J1ZQ2
331	A331S1YZQ	421	B421J2ZQ2	232	B232J72V3B2	227	B227J1ZQ2
334	A334S1YZQ	423	B423J2ZQ2	233	B233J72V3B2	231	B231J1ZQ2
421	A421S1YZQ	427	B427J2ZQ2	235	B235J72V3B2	232	B232J1ZQ2
423	A423S1YZQ	431	B431J2ZQ2	MP6-121	B121J63ZQ2	233	B233J1ZQ2
JMT-427	A427S1YZQ	MP1-432	B432J2ZQ2	MP6-123	B123J63ZQ2	MR1-235	B235J1ZQ2
431	A431S1YZQ	433	B433J2ZQ2	126	B126J63ZQ2	321	B321J1ZQ2
432	A432S1YZQ	435	B435J2ZQ2	127	B127J63ZQ2	323	B323J1ZQ2
433	A433S1YZQ	MF2-121	B121J21ZQ22M	131	B131J63ZQ2	327	B327J1ZQ2
434	A434S1YZQ	123	B123J21ZQ22M	221	B221J63ZQ2	331	B331J1ZQ2
JMT-435	A435S1YZQ	MP2-126	B126J21ZQ22M	MP6-223	B223J63ZQ2	MR1-421	B421J1ZQ2
LFH-121	A121P32Y5ZQ	127	B127J21ZQ22M	226	B226J63ZQ2	423	B423J1ZQ2
123	A123P32Y5ZQ	131	B131J21ZQ22M	227	B227J63ZQ2	427	B427J1ZQ2
126	A126P32Y5ZQ	221	B221J21ZQ22M	231	B221J63ZQ2	431	B431J1ZQ2
127	A127P32Y5ZQ	223	B223J21ZQ22M	232	B232J63ZQ2	432	B432J1ZQ2
LFH-131	A131P32Y5ZQ	MP2-226	B226J21ZQ22M	MP6-233	B233J63ZQ2	MR1-433	B433J1ZQ2
134	A134P32Y5ZQ	227	B227J21ZQ22M	235	B235J63ZQ2	435	B435J1ZQ2
221	A221P32Y5ZQ	231	B231J21ZQ22M	MP7-121	B121J60ZQ2	MR2-121	B121J11ZQ22M
223	A223P32Y5ZQ	232	B232J21ZQ22M	123	B123J60ZQ2	123	B123J11ZQ22M
226	A226P32Y5ZQ	233	B233J21ZQ22M	126	B126J60ZQ2	126	B126J11ZQ22M

* EATON PART NUMBERS ARE NOW ELECTROSWITCH PART NUMBERS.

CrossReference
FORMER EATON (JBT) PART NUMBER TO ELECTROSWITCH PART NUMBER*

Former Eaton Part No.	Electroswitch Part No.	Former Eaton Part No.	Electroswitch Part No.	Former Eaton Part No.	Electroswitch Part No.	Former Eaton Part No.	Electroswitch Part No.
MR2- 127	B127J11ZQ22M	MR6- 226	B226J53ZQ2	PB- 1261AV2Q	PB-12631AV2Q	PB1- 1262WB	PB-12612WB
131	B131J11ZQ22M	227	B227J53ZQ2	1261CB	PB-12631CB	1262ZQE	PB-12612ZQ
221	B221J11ZQ22M	231	B231J53ZQ2	1261CG	PB-12631CG	1262Z3B	PB-12612Z3B
223	B223J11ZQ22M	232	B232J53ZQ2	1261CGE	PB-12631CG	1263ABE	PB-12613AB
226	B226J11ZQ22M	233	B233J53ZQ2	1261CQ	PB-12631CQ	1263CB	PB-12613CB
MR2- 227	B227J11ZQ22M	MR6- 235	B235J53ZQ2	PB- 1261CQE	PB-12631CQ	PB1- 1263WB	PB-12613WB
231	B231J11ZQ22M	MR7- 121	B121J50ZQ2	1261ZB	PB-12631ZB	1263ZB	PB-12613ZB
232	B232J11ZQ22M	123	B123J50ZQ2	1261ZBE	PB-12631ZB	1263ZBE	PB-12613ZB
233	B233J11ZQ22M	126	B126J50ZQ2	1261ZB7E	PB-12631ZB7	1263ZG	PB-12613ZG
235	B235J11ZQ22M	127	B127J50ZQ2	1261ZG	PB-12631ZG	1263ZQE	PB-12613ZQ
MR2- 321	B321J11ZQ22M	MR7- 131	B131J50ZQ2	PB- 1261ZGE	PB-12631ZG	PB1- 1263ZG7	PB-12613ZG7
323	B323J11ZQ22M	221	B221J50ZQ2	1261ZG7E	PB-12631ZG7	PB2- 123	PB-12321ZQ
327	B327J11ZQ22M	223	B223J50ZQ2	1261ZQ	PB-12631ZQ	1233	PB-12323ZQ
331	B331J11ZQ22M	226	B226J50ZQ2	1262CG	PB-12632CG	126	PB-12621ZQ
421	B421J11ZQ22M	227	B227J50ZQ2	1262CQ	PB-12632CQ	126E	PB-12621ZQ
MR2- 423	B423J11ZQ22M	MR7- 231	B231J50ZQ2	PB- 1262WBE	PB-12632WB	PB2- 126WHITE	PB-12622ZQ
427	B427J11ZQ22M	232	B232J50ZQ2	1262ZB	PB-12632ZB	1261	PB-12621ZQ
431	B431J11ZQ22M	233	B233J50ZQ2	1262ZG	PB-12632ZG	PBS- 123	PBS-12331ZQ
432	B432J11ZQ22M	235	B235J50ZQ2	1262ZQ	PB-12632ZQ	123X	PBS-12300ZQ
433	B433J11ZQ22M	PB- 123	PB-12331ZQ	1262ZQE	PB-12632ZQ	126	PBS-12631ZQ
MR2- 435	B435J11ZQ22M	PB- 123E	PB-12331ZQ	PB- 1262Z3G	PB-12632Z3G	PBS- 126X	PBS-12600ZQ
MR3- 121	B121J3ZQ2	123MPC	PB-12331CQ	1263AB	PB-12633AB	PBS2- 126E	PBS-12621ZQ
123	B123J3ZQ2	123RED	PB-12333ZQ	1263AVB	PB-12633AVB	PBW- 126X	PBW-12600ZQ
126	B126J3ZQ2	123X	PB-12300ZQ	1263AVG7	PB-12623AVG7	126ZQE	PBW-12631ZQ
127	B127J3ZQ2	1230CB	PB-12300CB	1263-CG	PB-12633CG	126ZQE	PBW-12632ZQ
MR3- 131	B131J3ZQ2	PB- 1231AB	PB-12331AB	PB- 1263CGE	PB-12633CG	PBW2- 126	PBW-12621ZQA
221	B221J3ZQ2	1231AVQ	PB-12331AVQ	1263CQ	PB-12633CQ	PC1- 121	A121M1DRQ
223	B223J3ZQ2	1231CB	PB-12331CB	1263ZB	P6-12633ZB	123	A123M1DRQ
226	B226J3ZQ2	1231CGE	PB-12331CQ	1263ZBE	PB-12633ZB	126	A126M1DRQ
227	B227J3ZQ2	1231CQ	PB-12331CQ	1263ZG	PB-12633ZG	127	A127M1DRQ
MR3- 231	B231J3ZQ2	PB- 1231CQE	PB-12331CQ	PB- 1263ZG7	PB-12633ZG7	PC1- 131	A131M1DRQ
232	B232J3ZQ2	1231ZB	PB-12331ZB	1263ZQ	PB-12633ZQ	134	A134M1DRQ
233	B233J3ZQ2	1231ZG	PB-12331ZG	PB1- 123	PB-12311ZQ	PC2- 121	A121M1DR2Q
235	B235J3ZQ2	1231ZGE	PB-12331ZG	1231AB	PB-12311AB	123	A123M1DR2Q
321	B321J3ZQ2	1231ZG7	PB-12331ZG7	1231Z6	PB-12311ZB	126	A126M1DR2Q
MR3- 323	B323J3ZQ2	PB- 1232ZB	PB-12332ZB	PB1- 1231ZG	PB-12311ZG	PC2- 127	A127M1DR2Q
327	B327J3ZQ2	1233AVB	PB-12333AVB	1231ZG7	PB-12311ZG7	131	A131M1DR2Q
331	B331J3ZQ2	1233CG	PB-12333CG	1231Z3Q	PB-12311Z3Q	134	A134M1DR2Q
421	B421J3ZQ2	1233CQ	PB-12333CQ	1232ZB	PB-12312ZB	PS1- 1XX	PS1-1XXQ
423	B423J3ZQ2	1233ZB	PB-12333ZB	1232ZB7	P6-12312ZB7	100	PS1-100Q
MR3- 427	B427J3ZQ2	PB- 1233ZG	PB-12333ZG	PB1- 1232ZQE	PB-12312ZQ	PS1- 2XX	PS1-2XXQ
431	B431J3ZQ2	1233ZG7	PB-12333ZG7	1233ZG7	PB-12313ZG7	200	PS1-200Q
432	B432J3ZQ2	1233ZQ	PB-12333ZQ	126	PB-12611ZQ	PS2- 1XX	PS2-1XXQ
433	B433J3ZQ2	126	PB-12631ZQ	126G	PB-12611ZG	100	PS2-100Q
435	B435J3ZQ2	126AV2BE	PB-12631AV2B	126MPC	PB-12611CQ	2XX	PS2-2XXQ
M65- 121	B121J71V3B2	PB- 126CGE	PB-12631CG	PB1- 126RED	PB-12613ZQ	PS2- 200	PS2-200Q
123	B123J71V3B2	126CQ	PB-12631CQ	126WHITE	PB-12612ZQ	PS3- 1XX	PS1-1XXB
126	B126J71V3B2	126CQE	PB-12631CQ	1261AB	PB-12611AB	100	PS1-100B
127	B127J71V3B2	126E	PB-12631ZQ	1261ABE	PB-12611AB	2XX	PS1-2XXB
131	B121J71V3B2	126EWHITE	PB-12632ZQ	1261AQ	PB-12611AQ	200	PS1-200B
M65- 221	B221J71V3B2	PB- 126EX	PB-12600ZQ	PB1- 1261AVB	PB-12611AVB	PS4- 1XX	PS2-100B
223	B223J71V3B2	126G	PB-12631ZG	1261AVQ	PB-12611AVQ	2XX	PS2-2XXB
226	B226J71V3B2	126MPC	PB-12631CQ	1261CB	PB-12611CB	200	PS2-200B
227	B227J71V3B2	126RED	PB-12633ZQ	1261CQ	PB-12611CQ	PS5- 1XX	PS5-1XXQ
231	B231J71V3B2	126UL	PB-12631ZQ	1261WBE	PB-12611WB	100	PS5-100Q
MR5- 232	B232J71V3B2	PB- 126WHITE	PB-12632ZQ	PB1- 1261WG	PB-12611WG	PS6- 1XX	PS6-1XXQ
233	B233J71V3B2	126X	PB-12600ZQ	1261ZB	PB-12611ZB	100	PS6-100Q
235	B235J71V3B2	1260AB	PB-12600AB	1261ZBE	PB-12611ZB	PS7- 1XX	PS7-1XXB
MR6- 121	B121J53ZQ2	1260ZB	PB-12600ZB	1261ZG	PB-12611ZG	100	PS7-100B
123	B123J53ZQ2	1261AB	PB-12631AB	1261ZGE	PB-12611ZG	2XX	PS7-2XXB
M66- 126	B126J53ZQ2	PB- 1261ABE	PB-12631AB	PB1- 1261ZG7	PB-12611ZG7	PS7- 200	PS7-200B
127	B127J53ZQ2	1261AQ	PB-12631AQ	1261ZQ	PB-12611ZQ	PS8- 1XX	PS8-1XXB
131	B131J53ZQ2	1261AVQ	PB-12631AVQ	1261ZQE	PB-12611ZQ	100	PS8-100B
221	B221J53ZQ2	1261AV2B	PB-12631AV2B	1261Z3B	PB-12611Z3B	2XX	PS8-2XXB
223	B223J53ZQ2	1261AV2BE	PB-12631AV2B	1262CB	PB-12612CB	200	PS8-200B

* EATON PART NUMBERS ARE NOW ELECTROSWITCH PART NUMBERS.

CrossReference
FORMER EATON (JBT) PART NUMBER TO ELECTROSWITCH PART NUMBER*

Former Eaton Part No.	Electroswitch Part No.	Former Eaton Part No.	Electroswitch Part No.	Former Eaton Part No.	Electroswitch Part No.	Former Eaton Part No.	Electroswitch Part No.
PS9- 1XX 100 2XX 200	PS9-1XXB PS9-100B PS9-2XXB PS9-200B	T01- 234 235 321 323	A234S1YWB A235S1YWB A321S1YWB A323S1YWB	T04- 223 226 227 231	A223S1CWZQ A226S1CWZQ A227S1CWZQ A231S1CWZQ	T11- 123 126 127 131	A123S1HZQ A126S1HZQ A127S1HZQ A131S1HZQ
PS10- 1XX	PS10-1XXB	327	A327S1YWB	232	A232S1CWZQ	134	A134S1HZQ
PS10- 100 2XX 200	PS10-100B PS10-2XXB PS10-200B	T01- 331 334 421	A331S1YWB A334S1YWB A421S1YWB	T04- 233 234 235	A233S1CWZQ A234S1CWZQ A235S1CWZQ	T11- 221 223 226	A221S1HZQ A223S1HZQ A226S1HZQ
PS11- 1XX 100	PS11-1XXB PS11-100B	423 427	A423S1YWB A427S1YWB	321 323	A321S1CWZQ A323S1CWZQ	227 231	A227S1HZQ A231S1HZQ
PS11- 2XX 200	PS11-2XXB PS11-200B	T01- 431 432	A431S1YWB A432S1YWB	T04- 327 331	A327S1CWZQ A331S1CWZQ	T11- 232 233	A232S1HZQ A233S1HZQ
PS14- 1XXX 100 2XXX	PS14-1XXXQ PS14-100Q PS14-2XXXQ	433 434 435	A433S1YWB A434S1YWB A435S1YWB	334 421 423	A334S1CWZQ A421S1CWZQ A423S1CWZQ	234 235 321	A234S1HZQ A235S1HZQ A321S1HZQ
PS14- 200 PS15- 1XXX 100 2XXX 200	PS14-200Q PS15-1XXXQ PS15-100Q PS15-2XXXQ PS15-200Q	T02- 121 123 126 127 131	A121M1D9AB A123M1D9AB A126M1D9AB A127M1D9AB A131M1D9AB	T04- 427 431 432 433 434	A427S1CWZQ A431S1CWZQ A432S1CWZQ A433S1CWZQ A434S1CWZQ	T11- 323 327 331 334 421	A323S1HZQ A327S1HZQ A331S1HZQ A334S1HZQ A421S1HZQ
PS16- 1XXX 100 2XXX 200	PS16-1XXXQ PS16-100Q PS16-2XXXQ PS16-200Q	T02- 134 221 223 226	A134M1D9AB A221M1D9AB A223M1D9AB A226M1D9AB	T04- 435 T06- 121 123 126 127	A435S1CWZQ A121S1YZB A123S1YZB A126S1YZB A127S1YZB	T11- 423 427 431 432 433	A432S1HZQ A427S1HZQ A431S1HZQ A432S1HZQ A433S1HZQ
PS17- 1XXX	PS17-1XXXQ	227	A227M1D9AB	127	A127S1YZB	433	A433S1HZQ
PS17- 100 2XXX 200	PS17-100Q PS17-2XXXQ PS17-200Q	T02- 231 232 233	A231M1D9AB A232M1D9AB A233M1D9AB	T06- 131 134 221	A131S1YZB A134S1YZB A221S1YZB	T11- 434 435 T12- 121	A434S1HZQ A435S1HZQ A121S1YZQP
PS71- 1XXX 100	PS71-1XXB PS71-100B	234 235	A234M1D9AB A235M1D9AB	223 226	A223S1YZB A226S1YZB	123 126	A123S1YZQP A126S1YZQP
PS71- 2XX 200	PS71-2XXB PS71-200B	T03- 121 123	A121S1CXZQ A123S1CXZQ	T06- 227 231	A227S1YZB A231S1YZB	T12- 127 131	A127S1YZQP A131S1YZQP
PS72- 1XXX 100 2XX	PS72-1XXB PS72-100B PS72-2XXB	126 127 131	A126S1CXZQ A127S1CXZQ A131S1CXZQ	232 233 234	A232S1YZB A233S1YZB A234S1YZB	134 221 223	A134S1YZQP A221S1YZQP A223S1YZQP
PS72- 200 PS73- 1XX 100 2XX 200	PS72-200B PS73-1XXB PS73-100B PS73-2XXB PS73-200B	T03- 134 221 223 226 227	A134S1CXZQ A221S1CXZQ A223S1CXZQ A226S1CXZQ A227S1CXZQ	T06- 235 321 323 327 331	A235S1YZB A321S1YZB A323S1YZB A327S1YZB A331S1YZB	T12- 226 227 231 232 233	A226S1YZQP A227S1YZQP A231S1YZQP A232S1YZQP A233S1YZQP
PS81- 1XX 100 2XX 200	PS81-1XXB PS81-100B PS81-2XXB PS81-200B	T03- 231 232 233 234	A231S1CXZQ A232S1CXZQ A233S1CXZQ A234S1CXZQ	T06- 334 421 423 427	A334S1YZB A421S1YZB A423S1YZB A427S1YZB	T12- 234 235 321 323	A234S1YZQP A235S1YZQP A321S1YZQP A323S1YZQP
PS82- 1XX	PS82-1XXB	235	A235S1CXZQ	431	A431S1YZB	327	A327S1YZQP
PS82- 100 2XX 200	PS82-100B PS82-2XXB PS82-200B	T03- 321 323 327	A321S1CXZQ A323S1CXZQ A327S1CXZQ	T06- 432 433 434	A432S1YZB A433S1YZB A434S1YZB	T12- 331 334 421	A331S1YZQP A334S1YZQP A421S1YZQP
PS83- 1XX 100	PS83-1XXB PS83-100B	331 334	A331S1CXZQ A334S1CXZQ	435 T08- 121	A435S1YZB A121M1D9AVB	423 427	A423S1YZQP A427S1YZQP
PS83- 2XX 200	PS83-2XXB PS83-200B	T03- 421 423	A421S1CXZQ A423S1CXZQ	T08- 123 126	A123M1D9AVB A126M1D9AVB	T12- 431 432	A431S1YZQP A432S1YZQP
T01- 121 123 126	A121S1YWB A123S1YWB A126S1YWB	427 431 432	A427S1CXZQ A431S1CXZQ A432S1CXZQ	127 131 134	A127M1D9AVB A131M1D9AVB A134M1D9AVB	433 434 435	A433S1YZQP A434S1YZQP A435S1YZQP
T01- 127 131 134 221 223	A127S1YWB A131S1YWB A134S1YWB A221S1YWB A223S1YWB	T03- 433 434 435 T04- 121 123	A433S1CXZQ A434S1CXZQ A435S1CXZQ A121S1CXZQ A123S1CXZQ	T08- 221 223 226 227 231	A221M1D9AVB A223M1D9AVB A226M1D9AVB A227M1D9AVB A231M1D9AVB	T13- 121 123 126 127 131	A121S1YZ3Q A123S1YZ3Q A126S1YZ3Q A127S1YZ3Q A131S1YZ3Q
T01- 226 227 231 232 233	A226S1YWB A227S1YWB A231S1YWB A232S1YWB A233S1YWB	T04- 126 127 131 134 221	A126S1CXZQ A127S1CXZQ A131S1CXZQ A134S1CXZQ A221S1CXZQ	T08- 232 233 234 235 T11- 121	A232M1D9AVB A233M1D9AVB A234M1D9AVB A235M1D9AVB A121S1HZQ	T13- 134 221 223 226 227	A134S1YZ3Q A221S1YZ3Q A223S1YZ3Q A226S1YZ3Q A227S1YZ3Q

* EATON PART NUMBERS ARE NOW ELECTROSWITCH PART NUMBERS.

CrossReference
FORMER EATON (JBT) PART NUMBER TO ELECTROSWITCH PART NUMBER*

Former Eaton Part No.	Electroswitch Part No.	Former Eaton Part No.	Electroswitch Part No.	Former Eaton Part No.	Electroswitch Part No.	Former Eaton Part No.	Electroswitch Part No.
T13- 231	A231S1YZ3Q	T17- 126	A126L34YZQ	T19- 232	A232P12YZQ	T21- 421	A421L01YZQ
232	A232S1YZ3Q	127	A127L34YZQ	233	A233P12YZQ	423	A423L01YZQ
233	A233S1YZ3Q	131	A131L34YZQ	234	A234P12YZQ	427	A427L01YZQ
234	A234S1YZ3Q	134	A134L34YZQ	235	A235P12YZQ	431	A431L01YZQ
235	A235S1YZ3Q	221	A221L34YZQ	321	A321P12YZQ	432	A432L01YZQ
T13- 321	A321S1YZ3Q	T17- 223	A223L34YZQ	T19- 323	A323P12YZQ	T21- 433	A433L01YZQ
323	A323S1YZ3Q	226	A226L34YZQ	327	A327P12YZQ	434	A434L01YZQ
327	A327S1YZ3Q	227	A227L34YZQ	331	A331P12YZQ	435	A435L01YZQ
331	A331S1YZ3Q	231	A231L34YZQ	334	A334P12YZQ	T22- 121	A121L11YZQ
334	A334S1YZ3Q	232	A232L34YZQ	421	A421P12YZQ	123	A123L11YZQ
T13- 421	A421S1YZ3Q	T17- 233	A233L34YZQ	T19- 423	A423P12YZQ	T22- 126	A126L11YZQ
423	A423S1YZ3Q	234	A234L34YZQ	427	A427P12YZQ	127	A127L11YZQ
427	A427S1YZ3Q	235	A235L34YZQ	431	A431P12YZQ	131	A131L11YZQ
431	A431S1YZ3Q	321	A321L34YZQ	432	A432P12YZQ	134	A134L11YZQ
432	A432S1YZ3Q	323	A323L34YZQ	433	A433P12YZQ	221	A221L11YZQ
T13- 433	A433S1YZ3Q	T17- 327	A327L34YZQ	T19- 434	A434P12YZQ	T22- 223	A223L11YZQ
434	A434S1YZ3Q	331	A331L34YZQ	435	A435P12YZQ	226	A226L11YZQ
435	A435S1YZ3Q	334	A334L34YZQ	T20- 121	A121P42YZQ	227	A227L11YZQ
T14- 121	A121M1D9AV2B	421	A421L34YZQ	123	A123P42YZQ	231	A231L11YZQ
123	A123M1D9AV2B	423	A423L34YZQ	126	A126P42YZQ	232	A232L11YZQ
T14- 126	A126M1D9AV2B	T17- 427	A427L34YZQ	T20- 127	A127P42YZQ	T22- 233	A233L11YZQ
127	A127M1D9AV2B	431	A431L34YZQ	131	A131P42YZQ	234	A234L11YZQ
131	A131M1D9AV2B	432	A432L34YZQ	134	A134P42YZQ	235	A235L11YZQ
134	A134M1D9AV2B	433	A433L34YZQ	221	A221P42YZQ	321	A321L11YZQ
221	A221M1D9AV2B	434	A434L34YZQ	223	A223P42YZQ	323	A323L11YZQ
T14- 223	A223M1D9AV2B	T17- 435	A435L34YZQ	T20- 226	A226P42YZQ	T22- 327	A327L11YZQ
226	A226M1D9AV2B	T18- 121	A121L44YZQ	227	A227P42YZQ	331	A331L11YZQ
227	A227M1D9AV2B	123	A123L44YZQ	231	A231P42YZQ	334	A334L11YZQ
231	A231M1D9AV2B	126	A126L44YZQ	232	A232P42YZQ	421	A421L11YZQ
232	A232M1D9AV2B	127	A127L44YZQ	233	A233P42YZQ	423	A423L11YZQ
T14- 233	A233M1D9AV2B	T18- 131	A131L44YZQ	T20- 234	A234P42YZQ	T22- 427	A427L11YZQ
234	A234M1D9AV2B	134	A134L44YZQ	235	A235P42YZQ	431	A431L11YZQ
235	A235M1D9AV2B	221	A221L44YZQ	321	A321P42YZQ	432	A432L11YZQ
T15- 121	A121M1D9V30B	223	A223L44YZQ	323	A323P42YZQ	433	A433L11YZQ
123	A123M1D9V30B	226	A226L44YZQ	327	A327P42YZQ	434	A434L11YZQ
T15- 126	A126M1D9V30B	T18- 227	A227L44YZQ	T20- 331	A331P42YZQ	T22- 435	A435L11YZQ
127	A127M1D9V30B	231	A231L44YZQ	334	A334P42YZQ	T23- 121	A121T11TZQ
131	A131M1D9V30B	232	A232L44YZQ	421	A421P42YZQ	123	A123T11TZQ
134	A134M1D9V30B	233	A233L44YZQ	423	A423P42YZQ	221	A221T11TZQ
221	A221M1D9V30B	234	A234L44YZQ	427	A427P42YZQ	223	A223T11TZQ
T15- 223	A223M1D9V30B	T18- 235	A235L44YZQ	T20- 431	A431P42YZQ	T23- 323	A323T11TZQ
226	A226M1D9V30B	321	A321L44YZQ	432	A432P42YZQ	423	A423T11TZQ
227	A227M1D9V30B	323	A323L44YZQ	433	A433P42YZQ		
231	A231M1D9V30B	327	A327L44YZQ	434	A434P42YZQ		
232	A232M1D9V30B	331	A331L44YZQ	435	A435P42YZQ		
T15- 233	A233M1D9V30B	T18- 334	A334L44YZQ	T21- 121	A121L01YZQ		
234	A234M1D9V30B	421	A421L44YZQ	123	A123L01YZQ		
235	A235M1D9V30B	423	A423L44YZQ	126	A126L01YZQ		
T16- 121	A121M1D9V60B	427	A427L44YZQ	127	A127L01YZQ		
123	A123M1D9V60B	431	A431L44YZQ	131	A131L01YZQ		
T16- 126	A126M1D9V60B	T18- 432	A432L44YZQ	T21- 134	A134L01YZQ		
127	A127M1D9V60B	433	A433L44YZQ	221	A221L01YZQ		
131	A131M1D9V60B	434	A434L44YZQ	223	A223L01YZQ		
134	A134M1D9V60B	435	A435L44YZQ	226	A226L01YZQ		
221	A221M1D9V60B	T19- 121	A121P12YZQ	227	A227L01YZQ		
T16- 223	A223M1D9V60B	T19- 123	A123P12YZQ	T21- 231	A231L01YZQ		
226	A226M1D9V60B	126	A126P12YZQ	232	A232L01YZQ		
227	A227M1D9V60B	127	A127P12YZQ	233	A233L01YZQ		
231	A231M1D9V60B	131	A131P12YZQ	234	A234L01YZQ		
232	A232M1D9V60B	134	A134P12YZQ	235	A235L01YZQ		
T16- 233	A233M1D9V60B	T19- 221	A221P12YZQ	T21- 321	A321L01YZQ		
234	A234M1D9V60B	223	A223P12YZQ	323	A323L01YZQ		
235	A235M1D9V60B	226	A226P12YZQ	327	A327L01YZQ		
T17- 121	A121L34YZQ	227	A227P12YZQ	331	A331L01YZQ		
123	A123L34YZQ	231	A231P12YZQ	334	A334L01YZQ		

* EATON PART NUMBERS ARE NOW ELECTROSWITCH PART NUMBERS.

**Toggle Switch Cross Reference
C&K to Electroswitch**
STANDARD TOGGLE SWITCHES

BASIC SWITCH			OPTIONAL FEATURE CODES											
C&K		Electroswitch	Actuator & Finish		Anti-Rotation		Bushing Styles		Termination		Contact Materials		Other ④	
Std.	U.L. ①		C&K	Electroswitch	C&K	Electroswitch	C&K	Electroswitch	C&K	Electroswitch	C&K	Electroswitch	C&K	Electroswitch
7101	U11	A123	K1	K12			CW	CW						
7103	U13	A121							A	A				
7105	U15	A127	L	L01				CX	AV	AV ⑦	B	B		
7107	U17	A131							AV2	AV2 ⑦				
7108	U18	A126	L1	L11										
7109	U19	A134												
7201	U21	A223	L2	L21			D	D	C	C				
7203	U23	A221												
7205	U25	A227	L3	L34			D9	D9	R	R	G	G	E	⑥
7207	U27	A231							R2	R2				
7208	U28	A226	L3 ②	L35			H	H	V30	V30	Q	Q		
7209	U29	A234	(Red)						V40	V40				
7211	U211	A232	L3 ②	L36			H3	H3	V60	V60				
7213	U213	A233	(White)		P	③			V70	V70	K	K ⑧		
7215	U215	A235	L4			See Below		K	W	W			③	P ③
7301	U31	A323							W1	W1				
7303	U33	A321							W3	W3	L	L ⑧		
7305	U35	A327	M	M1					W4	W4				
7307	U37	A331						CW	TX ⑤					
7308	U38	N/A	P1	P11					Y	Y				
7309	U39	A334							Y5	Z	M	M ⑧		
7401	U41	A423	P3	P31					Z3	Z3				
7403	U43	A421												
7405	U45	A427	P4	P41										
7407	N/A	A431												
7408	U48	N/A	S	S1										
7409	U49	A434												
7411	U411	A432	T	T1										
7412	U413	A433												
7415	U415	A435	T1	T11			Y9	Y9						

- ① Electroswitch part numbers are supplied U.L. Approved as standard on switches with Q and G options.
- ② The color descriptions are spelled out at the end of the C&K part number. Ex. 7101L3YZQ with red handle.
- ③ The Electroswitch code for anti-rotation (P) is found at the end of the Electroswitch part number. Not available on T or T1.
- ④ Other options include anti-rotation feature for Electroswitch.
- ⑤ Corresponds with sealed bushing version for T or T1 Actuator. See page 40.
- ⑥ Epoxy seal standard on all terminal options.
- ⑦ Verify momentary position on '26', '31', and '33' circuits. See pages 38 and 42 Pos. "C" or consult factory.
- ⑧ See page 38.

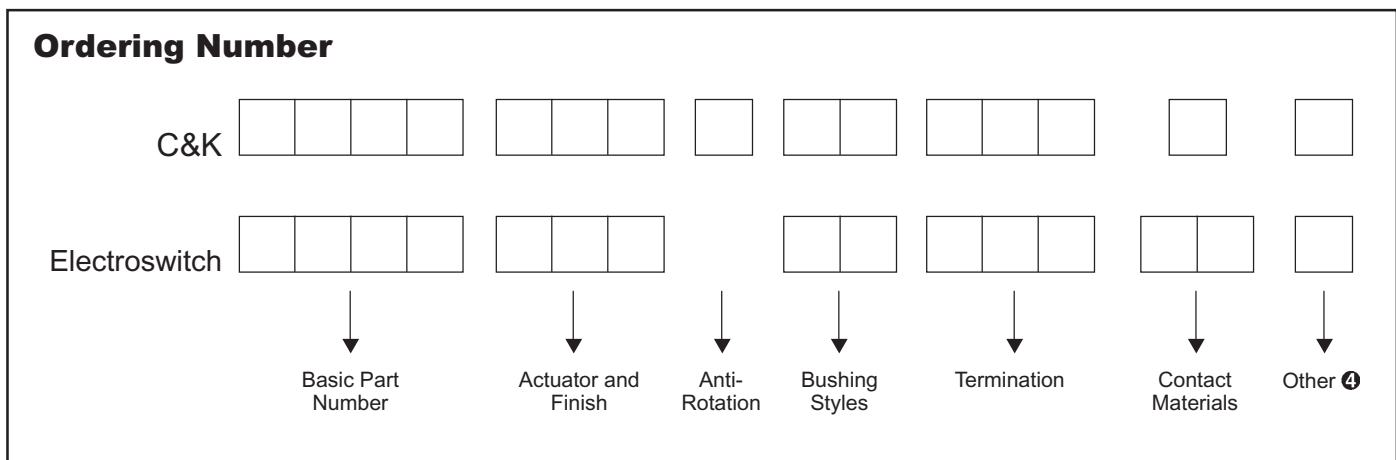
SELECTION GUIDE

**Rocker Switch Cross Reference
C&K to Electros witch**

STANDARD ROCKER AND PADDLE SWITCHES

BASIC SWITCH			OPTIONAL FEATURE CODES													
C&K		Electros witch	Actuators		Terminations		Contact Materials		Sealing		Actuator Color		Frame or Bezels		Other	
Std.	U.L. ①		C&K	Electros witch	C&K	Electros witch	C&K	Electros witch	C&K	Electros witch	C&K	Electros witch	C&K	Electros witch	C&K	Electros witch
7101	U11	B123														
7103	U13	B121												White ③	1P	
7105	U15	B127	J1 ②	J1										Black (Std.) ③	2P	
7107	U17	B131			A	A								Red ③	3P	
7108	U18	B126	J2 ②	J2	AV	AV1 ⑦					White	1				
7109	U19	B134	J3 ②	J3	AV2	AV2 ⑦	B	B								
7201	U21	B223	J5 ②	J5												
7203	U23	B221														
7205	U25	B227	J11 ③	J11	C	C					Black (Std.)	2		Black w/ L. E. D. Hole ③	4P	
7207	U27	B231														
7208	U28	B226	J21 ③	J21	V3	V3					Red	3		Green ③	5P	
7209	U29	B234														
7211	U211	B232	J37	J37	V4	V4								Blue ③	6P	
7213	U213	B233									Green	5				
7215	U215	B235	J47	J47	V5	V5				E				Bright Gray ③	8P	E ⑥
7301	U31	B323	J50 ②	J50	V6	V6					Blue	6				
7303	U33	B321						K	K ③					Yellow ③	9P	
7305	U35	B327	J51 ③	J50 ④	V7	V7										
7307	U37	B331									Light Gray	8		Dark Gray ③	0P	
7308	U38	N/A	J52 ③	J50 ⑤	W	W			L	L ③						
7309	U39	B334	J53 ②	J53	W1	W1					Yellow	9		Bright Chrome ③	1M	
7401	U41	B423	J60 ②	J60	W3	W3			M	M ③						
7403	U43	B421														
7405	U45	B427	J61 ③	J60 ④	W4	W4					Dark Gray	0		Black (Std.) ③	2M	
7407	N/A	B431														
7408	U48	N/A	J62 ③	J60 ⑤	Z	Z										
7409	U49	B434												Satin Chrome ③	3M	
7411	U411	B432	J63 ②	J63	Z3	Z3										
7412	U413	B433														
7415	U415	B435														

- ① Electros witch part numbers are supplied U.L. Approved as standard on switches with Q and G options.
- ② A complete C&K part number includes in **Word Form** an actuator color at the end of the part number. If none is indicated a black actuator will be supplied as standard. Ex. 7101J2ZB with red actuator is Electros witch part number B123J2ZB3.
- ③ A complete C&K part number includes in **Word Form** an actuator color and bezel color at the end of the part number. If none is indicated a black actuator and bezel will be supplied as standard. Ex. 7101J51CBE with white actuator and red frame is Electros witch part number B123J50CB22P.
- ④ A complete Electros witch part number must include one of the following bezel codes. 1P, 2P, 3P, 5P, 6P, 8P, 9P, 0P.
- ⑤ A complete Electros witch part number must include bezel code 4P.
- ⑥ Epoxy is standard on all terminal options.
- ⑦ Verify momentary position on '26', '31', and '33' circuits. See pages 24 and 30 Pos. "C" or consult factory.
- ⑧ See page 24.

SELECTION GUIDE

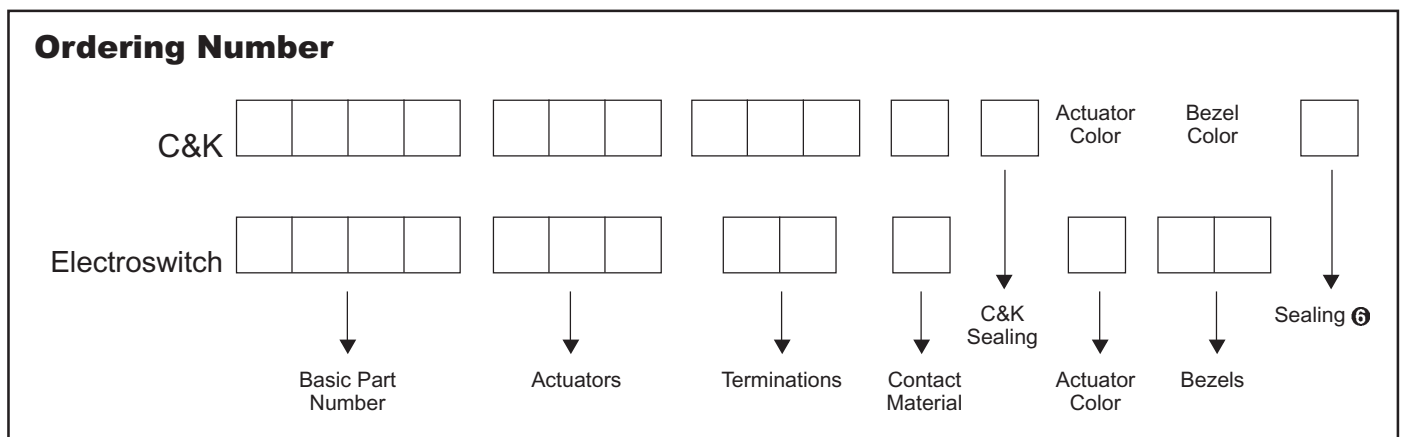

**Toggle Switch Cross Reference
 ALCO & C&K to Electros witch**
WASHABLE TOGGLE SWITCHES

BASIC SWITCH			OPTIONAL FEATURE CODES									
ALCO	C&K	Electros witch 5	Actuator & Finish		Bushing Styles		Termination		Contact Materials		Other	
			ALCO & C&K	Electros witch	ALCO & C&K	Electros witch	ALCO & C&K	Electros witch	ALCO & C&K	Electros witch	ALCO & C&K	Electros witch
AE101 AE103 AE105 AE107 AE108	E101 E103 E105 E107 E108	WT123 WT121 WT127 WT131 WT126	L ①	L01			A	A				
			L1 ①	L11	D1	D1	AV2	AV2 ⑦	B	B		
			L2 ①	L21			C	C	G	G		
			L3 ②	L34 ③	—	D9	V3	V3	Q	Q	E ②	④
AE201 AE203 AE205 AE207 AE208	E201 E203 E205 E207 E208	WT223 WT221 WT227 WT231 WT226	—	L44 ③	Y ②	Y	W	W	K	K ⑤		
			M	M1	—	Y9	W1	W1	L	L ⑥		
							W3	W3	M	M ⑥		
AE211 AE213 AE215	E211 — E215	WT232 WT233 WT235	S	S1			W4	W4				
							W5	—				
							Z	Z				
							Z3	Z3				

- ① ALCO only.
- ② C&K only.
- ③ Black std. See catalog for other colors.
- ④ Epoxy is standard on all terminal options for Electros witch & ALCO.
- ⑤ Electros witch part numbers are supplied U.L. approved as standard on switches with Q and G options.
- ⑥ See page 44.
- ⑦ Verify momentary position on '26', '31', and '33' circuits. See pages 44 and 47 Pos. "C" or consult factory.

**Rocker Switch Cross Reference
 ALCO & C&K to Electros witch**
WASHABLE ROCKER/PADDLE SWITCHES

BASIC SWITCH			OPTIONAL FEATURE CODES									
ALCO	C&K	Electros witch 1	Actuators		Terminations		Contact Materials		Sealing		Actuator Color	
			ALCO & C&K	Electros witch	ALCO & C&K	Electros witch	ALCO & C&K	Electros witch	ALCO & C&K	Electros witch	ALCO & C&K	Electros witch
AE101 AE103 AE105 AE107 AE108	E101 E103 E105 E107 E108	WP 123 (Paddle) 121 or 127 WR 131 (Rocker) 126	J1	J1 ② or J71 ②	A	A	B	B			White	1
			J2	J2 ② or J72 ②	AV2	AV2 ⑤	C	C	G	G	Black (Std.)	2
			J50	J76 ②	V3	V3	Q	Q	E ③	④	Red	3
AE201 AE203 AE205 AE207 AE208 AE211 AE213 AE215	E201 E203 E205 E207 E208 E211 — E215	WP 223 221 (Paddle) 227 Or 231 WR 226 232 (Rocker) 233 235	J60	J77 ②	W	W	K	K ⑤			Green	5
			J90 ③	—	W1	W1	L	L ⑥				
					W3	W3	M	M ⑥				
					W4	W4						
					Z	Z						
					Z3	Z3						

- ① Electros witch part numbers are supplied U.L. Approved as standard on switches with Q and G options.
- ② J1, J2 used with C, Z, Z3, W-W4 terminations. J71, J72, J76, J77 used with A, AV2, V3 terminations.
- ③ C&K only.
- ④ Epoxy is standard on all terminal options for Electros witch & ALCO.
- ⑤ Verify momentary position on '26', '31', and '33' circuits. See pages 32 and 35 Pos. "C" or consult factory.
- ⑥ See page 32.

Alcoswitch to Electroswitch Cross Reference
STANDARD MINIATURE SWITCHES

ALCO Part No.	Electroswitch Part No.	ALCO Part No.	Electroswitch Part No.	ALCO Part No.	Electroswitch Part No.	ALCO Part No.	Electroswitch Part No.
MDS-106D-50-0 MDS-106D-50 MDS-106D-60-0 MDS-106D-60 MDS-106E-50-0	B123J50ZQ2 B123J50ZQ ❶ B123J60ZQ2 B123J60ZQ ❶ B121J50ZQ2	MHV-106D-PC-10-0M MHV-106D-PC-10M MHV-106D-PC-20-0M MHV-106D-PC-20M MHV-106E-PC-20-0M	B123J71V3Q2 B123J71V3Q ❶ B123J72V3Q2 B123J72V3Q ❶ B121J72V3Q2	MPS-103F MPS-103F-PC MPS-103F-PCV MPS-103F-RA MPS-203R	PS1-100Q PS2-100G PS71-100Q PS9-100Q PS1-200Q	MRV-106E-PC-30M ❶ MRV-106E-PC-40M-0 MRV-106E-PC-40M ❶ MRV-106F-PC-30M-0 MRV-106F-PC-30M ❶	B121J73V3Q ❶ B121J75V3Q2 B121J75V3Q ❶ B126J73V3Q2 B126J73V3Q ❶
MDS-106E-50 MDS-106E-60-0 MDS-106E-60 MDS-106E-50-0 MDS-106F-50	B121J50ZQ ❶ B121J60ZQ2 B121J60ZQ ❶ B126J50ZQ2 B126J5ZQ ❶	MHV-106E-PC-20M MHV-106F-PC-10-0M MHV-106F-PC-10M MHV-106F-PC-20-0M MHV-106F-PC-20M	B121J72V3Q ❶ B126J71V3Q2 B126J71V3Q ❶ B126J72V3Q2 B126J72V2Q ❶	MPS-203R-PC MPS-203R-PCV MPS-203R-RA MPSR-103F MPSR-203R	PS2-200G PS71-200Q PS9-200Q PS14-100G PS14-200G	MRV-106F-PC-40M-0 MRV-106F-PC-40M ❶ MRV-206N-PC-30M-0 MRV-206N-PC-30M ❶ MRV-206N-PC-40M-0	B126J75V3Q2 B126J75V3Q ❶ B223J73V3Q2 B223J73V3Q ❶ B223J75V3Q2
MDS-106F-60-0 MDS-106F-60 MDS-206N-50-0 MDS-206N-50 MDS-206N-60-0	B126J60ZQ2 B126J60ZQ ❶ B223J50ZQ2 B223J50ZQ ❶ B223J60ZQ2	MHV-206N-PC-10-0M MHV-206N-PC-10M MHV-206N-PC-20-0M MHV-206N-PC-20M MHV-206P-PC-20-0M	B223J71V3Q2 B223J71V3Q ❶ B223J72V3Q2 B223J72V3Q ❶ B221J72V3Q2	NOTE — Pushbutton caps and bezels are ordered separately below and are not exactly interchangeable. Also the panel cut out for MPSR is NOT the same as C-H. C220 W-KN-17 C222 W-KN-17B C229 W-KN-17A C330 W-KN-18 C332 W-KN-18B C339 W-KN-18A SDR W-BZ-12	MRV-206N-PC-40M ❶ MRV-206P-PC-30M-0 MRV-206P-PC-30M ❶ MRV-206P-PC-40M-0 MRV-206P-PC-40M ❶	B223J75V3Q ❶ B221J73V3Q2 B221J73V3Q ❶ B221J75V3Q2 B221J75V3Q ❶	
MDS-206N-60 MDS-206P-50-0 MDS-206P-50 MDS-206P-60-0 MDS-206P-60	B223J60ZQ ❶ B221J50ZQ2 B221J50ZQ ❶ B221J60ZQ2 B221J60ZQ ❶	MHV-206P-PC-20M MHV-206R-PC-10-0M MHV-206R-PC-10M MHV-206R-PC-20-0M MHV-206R-PC-20M	B221J72V3Q ❶ B226J71V3Q2 B226J71V3Q ❶ B226J72V3Q2 B226J72V3Q ❶				MRV-206R-PC-30M-0 MRV-206R-PC-30M ❶ MRV-206R-PC-40M-0 MRV-206R-PC-40M ❶
MDS-206R-50-0 MDS-206R-50 MDS-206R-60-0 MDS-206R-60	B226J50ZQ2 B226J50ZQ ❶ B226J60ZQ2 B226J60ZQ ❶	MLD-106D-70-0 MLD-106D-70 MLD-106D-80-0 MLD-106D-80 MLD-106E-70-0	B123J50ZQ2 B123J50ZQ ❶ B123J60ZQ2 B123J60ZQ ❶ B121J50ZQ2	MRL-106D-30M-0 MRL-106D-30M MRL-106D-40M-0 MRL-106D-40M MRL-106E-30M-0	B123J3ZQ2 B123J3ZQ ❶ B123J5ZQ2 B123J5ZQ ❶ B121J3ZQ2	MSP-105D MSP-105F	PB-12331ZQ ❷ PB-12631ZQ ❷
MHL-106D-10M-0 MHL-106D-10M MHL-106D-20M-0 MHL-166D-20M MHL-106E-20M-0	B123J1ZQ2 B123J1ZQ ❶ B123J2ZQ2 B123J2ZQ ❶ B121J2ZQ2	MLD-106E-70 MLD-106E-80-0 MLD-106E-80 MLD-106F-70-0 MLD-106F-70	B121J50ZQ ❶ B121J60ZQ2 B121J60ZQ ❶ B126J50ZQ2 B126J50ZQ ❶	MRL-106E-30M MRL-106E-40M-0 MRL-106E-40M MRL-106F-30M-0 MRL-106F-30M	B121J3ZQ ❶ B121J5ZQ2 B121J5ZQ ❶ B126J3ZQ2 B126J3ZQ ❶	MST-105D MST-105E MST-105F MST-105G MST-105H	A123S1YZQ A121S1YZQ A134S1YZQ A127S1YZQ A131S1YZQ
MHL-106E-20M MHL-106F-10M-0 MHL-106F-10M MHL-106F-20M-0 MHL-106F-20M	B121J2ZQ ❶ B126J1ZQ2 B126J1ZQ ❶ B126J2ZQ2 B126J2ZQ ❶	MLD-106F-80-0 MLD-106F-80 MLD-206N-70-0 MLD-206N-70 MLD-206N-80-0	B126J60ZQ2 B126J60ZQ ❶ B223J50ZQ2 B223J50ZQ ❶ B223J60ZQ2	MRL-106F-40M-0 MRL-106F-40M MRL-206N-30M-0 MRL-206N-30M MRL-206N-40M-0	B126J5ZQ2 B126J5ZQ ❶ B223J3ZQ2 B223J3ZQ ❶ B223J5ZQ2	MST-115D MST-205N MST-205P MST-205PA MST-205R	A123S1YZQ w/W-CAP-10A A223S1YZQ A221S1YZQ A232S1YZQ A234S1YZQ
MHL-206N-10M-0 MHL-206N-10M MHL-206N-20M-0 MHL-206N-20M MHL-206P-20M-0	B223J1ZQ2 B223J1ZQ ❶ B223J2ZQ2 B223J2ZQ ❶ B221J2ZQ2	MLD-206N-80 MLD-206P-70-0 MLD-206P-70 MLD-206P-80-0 MLD-206P-80	B223J60ZQ ❶ B221J50ZQ2 B221J50ZQ ❶ B221J60ZQ2 B221J60ZQ ❶	MRL-206N-40M MRL-206P-30M-0 MRL-206P-30M MRL-206P-40M-0 MRL-206P-40M	B223J5ZQ ❶ B221J3ZQ2 B221J3ZQ ❶ B221J5ZQ2 B221J5ZQ ❶	MST-205S MST-205SA MST-205T MST-205TA MST-215N	A227S1YZQ A235S1YZQ A231S1YZQ A233S1YZQ A223S1YZQ w/W-CAP-10A
MHL-206P-20M MHL-206R-10M-0 MHL-206R-10M MHL-206R-20M-0 MHL-206R-20M	B221J2ZQ ❶ B226J1ZQ2 B226J1ZQ ❶ B226J2ZQ2 B226J2ZQ ❶	MLD-206R-70-0 MLD-206R-70 MLD-206R-80-0 MLD-206R-80	B226J50ZQ2 B226J50ZQ ❶ B226J60ZQ2 B226J60ZQ ❶	MRL-206R-30M-0 MRL-206R-30M MRL-206R-40M-0 MRL-206R-40M MRL-306D-30M-0	B226J3ZQ2 B226J3ZQ ❶ B226J5ZQ2 B226J5ZQ ❶ B323J3ZQ2	MST-305D MST-305E MST-305F MST-305H MST-315D	A323S1YZQ A321S1YZQ A334S1YZQ A331S1YZQ A323S1YZQ w/W-CAP-10A
MHL-306D-10M-0 MHL-306D-10M MHL-306D-20M-0 MHL-306D-20M MHL-306F-10M-0	B323J1ZQ2 B323J1ZQ ❶ B323J2ZQ2 B323J2ZQ ❶ B326J1ZQ2	MNL-206 ❸ MNL-206P ❸ MNL-206R ❸	SC12CWN1 ❸ SC12BWN1 ❸ SC12GWN1 ❸	MRL-306D-30M MRL-306D-40M-0 MRL-306D-40M MRL-406N-30M-0 MRL-406N-30M	B323J3ZQ ❶ B323J5ZQ2 B323J5ZQ ❶ B423J3ZQ2 B423J3ZQ ❶	MST-405N MST-405P MST-415N	A423S1YZQ A421S1YZQ A423S1YZQ w/W-CAP-10A
MHL-306F-10M MHL-306F-20M-0 MHL-306F-20M MHL-406N-10M-0 MHL-406N-10M	B326J1ZQ ❶ B326J2ZQ2 B326J2ZQ ❶ B423J1ZQ2 B423J1ZQ ❶	❸ Add Color of Rocker Code as Follows Red — 2 92 Amber — 4 94 Green — 5 93 White — 9 91		MRL-406N-40M-0 MRL-406N-40M	B423J5ZQ2 B423J5ZQ ❶		
MHL-406N-20M-0 MHL-406N-20M	B423J2ZQ2 B423J2ZQ ❶	MPA-106D MPA-106F	PB-12331ZQ ❷ PB-12631ZQ ❷	MRV-106D-PC-30M-0 MRV-106D-PC-30M ❶ MRV-106D-PC-40M-0 MRV-106D-PC-40M ❶ MRV-106E-PC-30M-0	B123J73V3Q2 B123J73V3Q ❶ B123J75V3Q2 B123J75V3Q ❶ B121J73V3Q2	MST-105D-PC MST-105E-PC MST-105F-PC MST-205N-PC MST-205P-PC	A123S1YQC A121S1YQC A126S1YQC A223S1YQC A221S1YQC
		MPE-106D MPE-106F	PBW-12331ZQ ❷ PBW-12631ZQ ❷			MST-205PA-PC	A232S1YQC

NOTE: ALCO Series MHL, MHV, MLD, MPA, MHL, MRV, MTA, MTB, MTE, MTP, MTG, MTL and MTM have molded-in terminals. If application requires sealing, Electroswitch can supply epoxy sealed terminals. Refer to Standard Option tables on pages 24 and 38 to determine correct part number.

❶ Refer to ordering table on page 24 for additional actuator colors and bezels.

❷ Depth behind panel not the same as ALCO.

Alcoswitch to Electros witch Cross Reference
STANDARD MINIATURE SWITCHES

ALCO Part No.	Electros witch Part No.	ALCO Part No.	Electros witch Part No.	ALCO Part No.	Electros witch Part No.	ALCO Part No.	Electros witch Part No.
MTA-106D	A123S1YZQ	MTA-206TA	A233S1YZQ	MTE-306E	A321S1CWZQ	MTL-106D	A123K12KZQ
MTA-106D-PC	A123S1YCC	MTA-306D	A323S1YZQ	MTE-406N	A423S1CWZQ	MTL-106E	A121K12KZQ
MTA-106D-RA	A123M1DAQ	MTA-306D-PC	A323S1YCC	MTE-406P	A421S1CWZQ	MTL-206N	A223K12KZQ
MTA-106D-VRA	A123M1DAVQ	MTA-306D-WW	A323S1YWB			MTL-206P	A221K12KZD
MTA-106D-WW	A123S1YWB	MTA-306E	A321S1YZQ			MTL-206PA	A232K12KZQ
				MTF-106D	A123P32YZQ		
MTA-106E	A121S1YZQ	MTA-306E-PC	A321S1YCC	MTF-106E	A121P32YZQ	MTL-306D	A323K12KZQ
MTA-106E-PC	A121S1YCC	MTA-306G	A331S1YZQ	MTF-106F	A126P32YZQ	MTL-406N	A423K12KZQ
MTA-106E-RA	A121M1DAQ	MTA-306H-PC	A331S1YCC	MTF-106G	A127P32YZQ	MTL-406PA	A432K12KZQ
MTA-106E-VRA	A121M1DAVQ	MTA-406N	A423S1YZQ	MTF-106H	A131P32YZQ		
MTA-106E-WW	A121S1YWB	MTA-406N-PC	A423S1YCC				
				MTF-126D	A123P31YZQ	MTM-106D-PC	A123M1DCQ
MTA-106F	A126S1YZQ	MTA-406N-WW	A423S1YWB	MTF-126E	A121P31YZQ	MTM-106D-RA	A123M1D9AQ
MTA-106F-PC	A126S1YCC	MTA-406P	A421S1YZQ	MTF-126F	A126P31YZQ	MTM-106D-VRA	A123M1D9AVQ
MTA-106F-RA	A126M1DAQ	MTA-406P-PC	A421S1YCC	MTF-126G	A127P31YZQ	MTM-106E-PC	A121M1DCQ
MTA-106F-VRA	A126M1DAVQ ❶	MTA-406PA	A432S1YZQ	MTF-126H	A131P31YZQ	MTM-106E-RA	A121M1D9AQ
MTA-106G	A127S1YZQ	MTA-406PA-PC	A432S1YCC				
				MTF-206N	A223P32YZQ	MTM-106E-VRA	A121M1D9AVQ
MTA-106G-PC	A127S1YCC	MTB-106D	A123L44YZQ	MTF-206P	A221P32YZQ	MTM-106F-PC	A126M1DCQ
MTA-106H	A131S1YZQ	MTB-106E	A121L44YZQ	MTF-206PA	A232P32YZQ	MTM-106F-RA	A126M1D9AQ
MTA-106H-PC	A131S1YCC	MTB-106F	A126L44YZQ	MTF-206R	A226P32YZQ	MTM-106F-VRA	A126M1D9AVQ ❶
MTA-206N	A223S1YZQ	MTB-106G	A127L44YZQ	MTF-206S	A227P32YZQ	MTM-106G-PC	A127M1DCQ
MTA-206N-PC	A223S1YCC	MTB-106H	A131L44YZQ				
				MTF-206SA	A235P32YZQ	MTM-106H-PC	A131M1DCQ
MTA-206N-RA	A223M1DAQ	MTB-206N	A223L44YZQ	MTF-206T	A231P32YZQ	MTM-206N-PC	A223M1DCQ
MTA-206N-VRA	A223M1DAVQ	MTB-206P	A221L44YZQ	MTF-226N	A223P31YZQ	MTM-206N-BA	A223M1D9AQ
MTA-206N-WW	A223S1YWB	MTB-206PA	A232L44YZQ	MTF-226P	A221P31YZQ	MTM-206N-VRA	A223M1D9AVQ
MTA-206P	A221S1YZQ	MTB-206R	A226L44YZQ	MTF-226PA	A233P31YZQ	MTM-206P-PC	A221M1DCQ
MTA-206P-PC	A221S1YCC	MTB-206S	A227L44YZQ				
				MTF-226R	A226P31YZQ	MTM-206P-RA	A221M1D9AQ
MTA-206P-RA	A221M1DAQ	MTB-206T	A231L44YZQ	MTF-226S	A227P31YZQ	MTM-206P-VRA	A221M1D9AVQ
MTA-206P-VRA	A221M1DAVQ	MTB-306D	A323L44YZQ	MTF-226SA	A235P31YZQ	MTM-206PA-PC	A233M1DCQ
MTA-206P-WW	A221S1YWB	MTB-406D	A423L44YZQ	MTF-226T	A231P31YZQ	MTM-206R-PC	A226M1DCQ
MTA-206PA	A232S1YZQ			MTF-306N	A323P32YZQ	MTM-206R-RA	A226M1D9AQ
MTA-206PA-PC	A232S1YCC						
				MTF-326N	A323P31YZQ	MTM-206R-VRA	A226M1D9AVQ ❶
MTA-206R	A226S1YZQ	MTE-106D	A123S1CWZQ	MTF-406N	A423P32YZQ	MTM-206S-PC	A227M1DCQ
MTA-206R-PC	A226S1YCC	MTE-106E	A121S1CWZQ	MTF-426N	A423P31YZQ	MTM-206T-PC	A231M1DCQ
MTA-206R-RA	A226M1DAQ	MTE-106F	A126S1CWZQ			MTM-306D-PC	A323M1DCQ
MTA-206R-VRA	A226M1DAVQ ❶	MTE-106G	A127S1CWZQ			MTM-406N-PC	A423M1DCQ
MTA-206S	A227S1YZQ	MTE-106H	A131S1CWZQ				
				MTG-106D	A123T11TZQ		
MTA-206S-PC	A227S1YCC	MTE-206N	A223S1CWZQ	MTG-106E	A121T11TZQ		
MTA-206SA	A235S1YZQ	MTE-206P	A221S1CWZQ	MTG-206N	A223T11TZQ		
MTA-206SA-PC	A235S1YCC	MTE-206PA	A232S1CWZQ	MTG-206N-PC	A223T11TCQ		
MTA-206T	A231S1YZQ	MTE-206R	A226S1CWZQ	MTG-206P	A221T11TZQ		
MTA-206T-PC	A231S1YCC	MTE-206S	A227S1CWZQ				
				MTG-306D	A323T11TZQ		
				MTG-406N	TA423T11TZQ		

NOTE: ALCO Series MHL, MHV, MLD, MPA, MRL, MRV, MTA, MTB, MTE, MTF, MTG, MTL and MTM have molded-in terminals. If application requires sealing, Electros witch can supply epoxy sealed terminals. Refer to Standard Option tables on pages 24 and 38 to determine correct part number.

❶ Momentary position opposite that of ALCO. See Note ❷ on page 64.

Alcoswitch to Electros witch Cross Reference
WASHABLE MINIATURE SWITCHES

ALCO Part No.	Electros witch Part No.	ALCO Part No.	Electros witch Part No.	ALCO Part No.	Electros witch Part No.	ALCO Part No.	Electros witch Part No.
AE101J1AB0	WR123J71AB2	AE101SD1AB	WT123S1D1AB	AE103MD1AB	WT121M1D1AB	AE105J2ZQ0	WP127J2ZQ2
AE101J1AV2B0	WR123J71AV2B2	AE101SD1AV2B	WT123S1D1AV2B	AE103MDAV2B	WT121M1D1AV2B	AE105L1D1ZQ	WT127L01D1ZQ
AE101J1V3B0	WR123J71V3B2	AE101SD1V30B	WT123S1D1V30B	AE103MDV30B	WT121M1D1V30B	AE105L1D1ZQ	WT127L11D1ZQ
AE101J1ZQ0	WR123J1ZQ2	AE101SD1ZQ	WT123S1D1ZQ	AE103MDZQ	WT121M1D1ZQ	AE105L2D1ZQ	WT127L21D1ZQ
AE101J2AB0	WP123J72AB2	AE103J1AB0	WR121J71AB2	AE103SD1AB	WT121S1D1AB	AE105MD1AB	WT127M1D1AB
AE101J2AV2B0	WP123J72AV2B2	AE103J1AV2B0	WR121J71AV2B2	AE103SD1AV2B	WT121S1D1AV2B	AE105MD1AV2B	WT127M1D1AV2B
AE101J2V3B0	WP123J72V3B2	AE103J1V3B0	WR121J71V3B2	AE103SD1V30B	WT121S1D1V30B	AE105MD1V30B	WT127M1D1V30B
AE101J2ZQ0	WP123J2ZQ2	AE103J1ZQ0	WR121J1ZQ2	AE103SD1ZQ	WT121S1D1ZQ	AE105MD1ZQ	WT127M1D1ZQ
AF101L1D1ZQ	WT123L01D1ZQ	AE103J2AB0	WP121J72AB2	AE105J1AB0	WR127J71AB2	AE105SD1AB	WT127S1D1AB
AE101L1D1ZQ	WT123L11D1ZQ	AE103J2AV2B0	WP121J72AV2B2	AE105J1AV2B0	WR127J71AV2B2	AE105SD1AV2B	WT127S1D1AV2B
AE101L2D1ZQ	WT123L21D1ZQ	AE103J2V3B0	WP121J72V3B2	AE105J1V3B0	WR127J71V3B2	AE105SD1V30B	WT127S1D1V30B
AE101MD1AB	WT123M1D1AB	AE103J2ZQ0	WP121J2ZQ2	AE105J1ZQ0	WR127J71ZQ2	AE105SD1ZQ	WT127S1D1ZQ
AE101MD1AV2B	WT123M1D1AV2B	AE103LD1ZQ	WT121L01D1ZQ	AE105J2AB0	WP127J72AB2	AE107J1AB0	WR131J71AB2
AE101MD1V30B	WT123M1D1V30B	AE103L1D1ZQ	WT121L11D1ZQ	AE105J2AV2B0	WP127J72AV2B2	AE107J1AV2B0	WR131J71AV2B2 ❶
AE101MD1ZQ	WT123M1D1ZQ	AE103L2D1ZQ	WT121L21D1ZQ	AE105J2V3B0	WP127J72V3B2	AE107J1V3B0	WR131J71V3B2

❶ Momentary position opposite that of ALCO. See Notes ❷ or ❸ on page 66.

Alcoswitch to Electroswitch Cross Reference
WASHABLE MINIATURE SWITCHES

ALCO Part No.	Electroswitch Part No.	ALCO Part No.	Electroswitch Part No.	ALCO Part No.	Electroswitch Part No.	ALCO Part No.	Electroswitch Part No.
AE107J12Q0 AE107J2AB0 AE107J2AV2B0 AE107J2V3B0 AE107J2ZQ0	WR131J1ZQ2 WP131J72AB2 WP131J72AV2B2 ① WP131J72V3B2 WP131J2ZQ2	AE203J1AV2B0 AE203J1V3B0 AE203J1ZQ0 AE203J2AB0 AE203J2AV2B0	WR221J71AV2B2 WR221J71V3B2 WR221J1ZQ2 WP221J72AB2 WP221J72AV2B2	AE207SD1ZQ AE208J1AB0 AE208J1AV2B0 AE208J1V3B0 AE208J1ZQ0	WT231S1D1ZQ WR226J71AB2 WR226J71AV2B2 ① WR226J71V3B2 WR226J1ZQ2	AE213SD1AV2B AE213SD1V30B AE213SD1ZQ AE215J1AB0 AE215J1AV2B0	WT233S1D1AV2B ① WT233S1D1V30B WT233S1D1ZQ WR235J71AB2 WR235J71AV2B
AE107LD1ZQ AE107L1D1ZQ AE107L2D1ZQ AE107MD1AB AE107MD1AV2B	WT131L01D1ZQ WT131L11D1ZQ WT131L21D1ZQ WT131M1D1AB WT131M1D1AV2B ①	AE203J2V2B0 AE203L2ZQ0 AE203LD1ZQ AE203L1D1ZQ AE203L2D1ZQ	WP221J72V3B2 WP221J2ZQ WT221L01D1ZQ WT221L11D1ZQ WT221L21D1ZQ	AE208J2AB0 AE208J2AV2B0 AE208J2V3B0 AE208J2ZQ0 AE208LD1ZQ	WP226J72AB2 WP226J72AV2B2 ① WP226J72V3B2 WP226J2ZQ2 WT226L01Q1ZQ	AE215J1V3B0 AE215J1ZQ0 AE215J2AB0 AE215J2AV2B0 AE215J2V3B0	WR235J1V3B2 WR235J1ZQ2 WP235J2AB2 WP235J2AV2B2 WP235J2V3B
AE107MD1V30B AE107MD1ZQ AE107SD1AB AE107SD1AV2B AE107SD1V30B	WT131M1D1V30B WT131M1D1ZQ WT131S1D1AB WT131S1D1AV2B ① WT131S1D1V30B	AE203MD1AB AE203MDAV2B AE203MDV30B AE203MDZQ AE203SD1AB	WT221M1D1AB WT221M1D1AV2B WT221M1D1V30B WT221S1D1AB WT221S1D1AB	AE208L1D1ZQ AE208L2D1ZQ AE208MD1AB AE208MD1AV2B AE208MD1V30B	WT226L11D1ZQ WT226L21D1ZQ WT226M1D1AB WT226M1D1AV2B ① WT226M1D1V30B	AE215J2ZQ0 AE215LD1ZQ AE215L1D1ZQ AE215L2D1ZQ AE215MD1AB	WP235J2ZQ2 WT235L01D1ZQ WT235L11D1ZQ WT235L21D1ZQ WT235M1D1AB
AE107SD1ZQ AE108J1AB0 AE108J1AV2B0 AE108J1V3B0 AE108J1ZQ0	WT131S1D1ZQ WR126J71AB2 WR126J71AV2B2 ① WR126J71V3B2 WR126J71ZQ2	AE203SD1AV2B AE203SD1V30B AE203SD1ZQ AE205J1AB0 AE205J1AV2B0	WT221S1D1AV2B WT221S1D1V30B WT221S1D1ZQ WR227J71AB2 WR227J71AV2B2	AE208MD1ZQ AE208SD1AB AE208SD1AV2B AE208SD1V30B AE208SD1ZQ	WT126M1D1ZQ WT226S1D1AB WT226S1D1AV2B ① WT226S1D1V30B WT226S1D1ZQ	AE215MD1AV2B AE215MD1V30B AE215MD1ZQ AE215SD1AB AE215SD1AV2B	WT235M1D1AV2B WT235M1D1V30B WT235M1D1ZQ WT235S1D1AB WT235S1D1AV2B
AE108J2AB0 AE108J2AV2B0 AE108J2V3B0 AE108J2ZQ0 AE108LD1ZQ	WP126J72AB2 WP126J72AV2B2 ① WP126J72V3B2 WP126J2ZQ2 WT126L01D1ZQ	AE205J1V3B0 AE205J1ZQ0 AE205J2AB0 AE205J2AV2B0 AE205J2V3B0	WR227J71V3B2 WR227J1ZQ2 WP227J72AB2 WP227J72AV2B2 WP227J72V3B2	AE211J1AB0 AE211J1AV2B0 AE211J1V3B0 AE211J1ZQ0 AE211J2AB0	WT232J71AB2 WR232J71AV2B WR232J71V3B2 WR232J1ZQ2 WP232J72AB2	AE215SD1V30B AE215SD1ZQ	WT235S1D1V30B WT235S1D1ZQ
AE108L1D1ZQ AE108L2D1ZQ AE108MD1AB AE108MD1AV2B AE108MD1V30B	WT126L11D1ZQ WT126L21D1ZQ WT126M1D1AB WT126M1D1AV2B ① WT126M1D1V30B	AE205J2ZQ0 AE205LD1ZQ AE205L1D1ZQ AE205L2D1ZQ AE205MD1AB	WP227J2ZQ2 WT227L01D1ZQ WT227L11D1ZQ WT227L21D1ZQ WT227M1D1AB	AE211J2AV2B0 AE211J2V3B0 AE211J2ZQ0 AE211LD1ZQ AE211D1ZQ	WP232J72AV2B2 WP232J72V3B2 WP232J2ZQ2 WT232L01D1ZQ WT232L11D1ZQ		
AE108MD1ZQ AE108SD1AB AE108SD1AV2B AE108SD1V30B AE108SD1ZQ	WT126M1D1ZQ WT126S1D1AB WT126S1D1AV2B ① WT126S1D1V30B WT126S1D1ZQ	AE205MD1AV2B AE205MD1V30B AE205MD1ZQ AE205SD1AB AE205SD1AV2B	WT227M1D1AV2B WT227M1D1V30B WT227M1D1ZQ WT227S1D1AB WT227S1D1AV2B	AE211L2D1ZQ AE211MD1AB AE211MD1AV2B AE211MD1V30B AE211MD1ZQ	WT232L21D1ZQ WT232M1D1AB WT232M1D1AV2B WT232M1D1V30B WT232M1D1ZQ		
AE201J1AB0 AE201J1AV2B0 AE201J1V3B0 AE201J1ZQ0 AE201J2AB0	WR223J71AB2 WT223J71AV2B2 WR223J71V3B2 WR223J1ZQ2 WP223J72AB2	AE205SD1V30B AE205SD1ZQ AE207J1AB0 AE207J1AV2B0 AE207J1V3B0	WT227S1D1V30B WT227S1D1ZQ WR231J71AB2 WR231J71AV2B2 WR231J71V3B2	AE211SD1AB AE211SD1AV2B AE211SD1V30B AE211SD1ZQ AE213J1AB0	WT232S1D1AB WT232S1D1AV2B WT232S1D1V30B WT232S1D1ZQ WR233J71AB2		
AE201J2AV2B0 AE201J2V3B0 AE201J2ZQ0 AE201LD1ZQ AE201L1D1ZQ	WP223J72AV2B2 WP223J72V3B2 WP223J2ZQ2 WT223L01D1ZQ WT223L11D1ZQ	AE207J1ZQ0 AE207J2AB0 AE207J2AV2B0 AE207J2V3B0 AE207J2ZQ0	WR231J1ZQ2 WP231J72AB2 WP231J72AB2 ① WP231J72V3B2 WP231J2ZQ2	AE213J1AV2B0 AE213J1V3B0 AE213J1ZQ0 AE213J2AB0 AE213J2AV2B0	WR233J71AV2B2 ① WR233J71V3B2 WR233J1ZQ2 WP233J72AB2 WP233J72AV2B2 ①		
AE201L2D1ZQ AE201MD1AB AE201MD1AV2B AE201MD1V30B AE201MD1ZQ	WT223L21D1ZQ WT223M1D1AB WT223M1D1AV2B WT223M1D1V30B WT223M1D1ZQ	AE207LD1ZQ AE207L1D1ZQ AE207L2D1ZQ AE207MD1AB AE207MD1AV2B	WT231L01D1ZQ WT231L11D1ZQ WT231L21D1ZQ WT231M1D1AB WT231M1D1AV2B ①	AE213J2V3B0 AE213J2ZQ0 AE213LD1ZQ AE213L1D1ZQ AE213L2D1ZQ	WP233J72V3B2 WP233J2ZQ2 WT233L01D1ZQ WT233L11D1ZQ WT233L21D1ZQ		
AE201SD1AB AE201SD1AV2B AE201SD1V30B AE201SD1ZQ AE203J1AB0	WT223S1D1AB WT223S1D1AV2B WT223S1D1V30B WT223S1D1ZQ WR221J71AB2	AE207MD1V30B AE207MD1ZQ AE207SD1AB AE207SD1AV2B AE207SD1V30B	WT231M1D1V30B WT231M1D1ZQ WT231S1D1AB WT231S1D1AV2B ① WT231S1D1V30B	AE213MD1AB AE213MD1AV2B AE213MD1V30B AE213MD1ZQ AE213SD1AB	WT233M1D1AB WT233M1D1AV2B ① WT233M1D1V30B WT233M1D1ZQ WT233S1D1AB		

① Momentary position opposite that of ALCO. See Notes ⑤ or ⑦ on page 66.

C&K to Electros witch Cross Reference
STANDARD MINIATURE SWITCHES

C&K Part No.	Electros witch Part No.	C&K Part No.	Electros witch Part No.	C&K Part No.	Electros witch Part No.	C&K Part No.	Electros witch Part No.
5101ZQ	SC11CWN191	7101SYZ3QE	A123S1Y23Q	7105P4YZQ	A127P41YZQ	7108MDR2Q	A126M1DR2Q
5103ZQ	SC11BWN191	T1CWYZQ	A123T11TWZQ	SCWZQ	A127S1CWZQ	P1YZQ	A126P11YZQ
5105ZQ	SC11JWN191	T1ZQ	A123T11TZQ	SHZQ	A127S1HZQ	P3YZQ	A126P31YZQ
5107ZQ	SC11FVN191			SPYZQ	A127S1H3ZQP	P4YZQ	A126P41YZQ
5108ZQ	SC11GWN191	7103J1V3B	B121J1V3B2	SYCQ	A127S1YCQ	SCWZQ	A126S1CWZQ
		J1ZQ	B121J1ZQ2				
5201ZQ	SC12CWN191	J2V3B	B121J2V3B2	7105SYWBE	A127S1YWB	7108SHZQ	A126S1HZQ
5203ZQ	SC12BWN191	J2ZQ	B121J1ZQ2	SYZB	A127S1YZB	SPYZQ	A126S1H3ZQP
5205ZQ	SC12JWN191	J3ZQ	B121J3ZQ2	SYZQ	A127S1YZQ	SYCQ	A126S1YCQ
5207ZQ	SC12FVN191			SYZ3QE	A127S1YZ3Q	SYWBE	A126S1YWB
5208ZQ	SC12GWN191	7103J5ZQ	B121J5ZQ2			SYZB	A126S1YZB
		J11ZQ	B121J11ZQ22M	7107J1V3B	B131J71V3B2		
5600ZB	SC12LWN191	J21ZQ	B121J21ZQ22M	J1ZQ	B131J1ZQ2	7108SYZQ	A126S1YZQ
		J50ZQ	B121J50ZQ2	J2V3B	B131J72V3B2	SYZ3QE	A126S1YZ3Q
		J53ZQ	B121J53ZQ2	J2ZQ	B131J2ZQ2		
7002	W-NU-11			J3ZQ	B131J3ZQ2		
7003-2	W-WA-20	7103J60ZQ	B121J60ZQ2			7109L1YZQ	A134L11YZQ
7003-3	W-WA-16	J63ZQ	B121J63ZQ2	7107J5ZQ	B131J5ZQ2	L3YZQ	A134L34YZQ
7007	W-RI-12	K1ZQ	A121K1KZQ	J11ZQ	B131J11ZQ22M	LYZQ	A134L01YZQ
7062 White	W-CAP-10A	L1YZQ	A121L11YZQ	J21ZQ	B131J21ZQ22M	MD9AB	A134M1D9AB
		L3YZQ	A121L34YZQ	J50ZQ	B131J50ZQ2	MD9AVB	A134M1D9AVB
				J53ZQ	B131J53ZQ2		
7062 Black	W-CAP-10D	7103LYZQ	A121L01YZQ	7107J60ZQ	B131J60ZQ2	7109MD9AV2B	A134M1D9AV2B
7062 Red	W-CAP-10C	MD9AB	A121M1D9AB	J63ZQ	B131J63ZQ2	MD9V30B	A134M1D9V30B
7062 Orange	W-CAP-10F	MD9AVB	A121M1D9AVB	L1YZQ	A131L11YZQ	MD9V60B	A134M1D9V60B
7062 Yellow	W-CAP-10G	MD9AV2B	A121M1D9AV2B	L3YZQ	A131L34YZQ	MDRQ	A134M1DRQ
7062 Green	W-CAP-10H	MD9V30B	A121M1D9V30B	LYZQ	A131L01YZQ	MDR2Q	A134M1DR2Q
7062 Blue	W-CAP-10B	7103MD9V60B	A121M1D9V60B	7107MD9AB	A131M1D9AB	7109P1YZQ	A134P11YZQ
7062 Brown	W-CAP-10E	MDRQ	A121M1DRQ	MD9AVB	A131M1D9AVB ①	P3YZQ	A134P31YZQ
7062 Grey	W-CAP-10J	MDR2Q	A121M1DR2Q	MD9AV2B	A131M1D9AV2B ①	P4YZQ	A134P41YZQ
7071	W-NU-10A	P1YZQ	A121P11YZQ	MD9V30B	A131M1D9V30B	SCWZQ	A134S1CWZQ
7072	W-RI-10	P3YZQ	A121P31YZQ	MD9V60B	A131M1D9V60B	SHZQ	A134S1HZQ
7089 White	W-KN-16A	7103P4YZQ	A121P41YZQ	7107MDRQ	A131M1DRQ	7109SPYZQ	A134S1H3ZQP
7089 Black	W-KN-16	SCWZQ	A121S1CWZQ	MDR2Q	A131M1DR2Q	SYCQ	A134S1YCQ
7089 Red	W-KN-16B	SHZQ	A121S1HZQ	P1YZQ	A131P11YZQ	SYWBE	A134S1YWB
7099	W-NU-19B	SPYZQ	A121S1H3ZQP	P3YZQ	A131P31YZQ	SYZB	A134S1YZB
		SYCQ	A121S1YCQ	P4YZQ	A131P41YZQ	SYZQ	A134S1YZQ
7101J1V3B	B123J71V3B2						
J1ZQ	B123J1ZQ2	7103SYWBE	A121S1YWB	7107SCWZQ	A131S1CWZQ	7201J1V3B	B223J71V3B2
J2V3B	B123J72ZQ2	SYZB	A121S1YZB	SHZQ	A131S1HZQ	J1ZQ	B223J1ZQ2
J2ZQ	B123J2ZQ2	SYZQ	A121S1YZQ	SPYZQ	A131S1H3ZQP	J2V3B	B223J72V3B2
J3ZQ	B123J3ZQ2	SYZ3QE	A121S1Y23Q	SYCQ	A131S1YCQ	J2ZQ	B223J2ZQ2
		T1CWYZQ	A121T11TWZQ	SYWBE	A131S1YWB	J3ZQ	B223J3ZQ2
7101J5ZQ	B123J5ZQ2						
J11ZQ	B123J11ZQ22M	7103T1ZQ	A121T11TZQ	7107SYZB	A131S1YZB	7201J5ZQ	B223J5ZQ2
J21ZQ	B123J21ZQ22M			SYZQ	A131S1YZQ	J11ZQ	B223J11ZQ22M
J50ZQ	B123J50ZQ2	7105J1ZQ	B127J1ZQ2	SYZ3QE	A131S1YZ3Q	J21ZQ	B223J21ZQ22M
J53ZQ	B123J53ZQ2	J1V3B	B127J1V3B2			J50ZQ	B223J50ZQ2
		J2ZQ	B127J2ZQ2	7108J1V3B	B126J71V3B2	J53ZQ	B223J53ZQ2
7101J60ZQ	B123J60ZQ2			J1ZQ	B126J1ZQ2		
J63ZQ	B126J63ZQ2	7105J5ZQ	B127J5ZQ2	J2V3B	B126J72V3B2	7201J60ZQ	B223J60ZQ2
K1ZQ	A123K1KZQ	J11ZQ	B127J11ZQ22M	J2ZQ	B126J2ZQ2	J63ZQ	B223J63ZQ2
L1YZQ	A123L11YZQ	J21ZQ	B127J21ZQ22M	J3ZQ	B126J3ZQ2	K1ZQ	A223K11KZQ
L3YZQ	A123L34YZQ	J50ZQ	B127J50ZQ2			L1YZQ	A223L11YZQ
		J53ZQ	B127J53ZQ2	7108J5ZQ	B126J5ZQ2	L3YZQ	A223L34YZQ
				J11ZQ	B126J11ZQ22M		
7101L1YZQ	A123L01YZQ			J21ZQ	B126J21ZQ22M	7201LYZQ	A223L01YZQ
MD9AB	A123M1D9AB	7105J60ZQ	B127J60ZQ2	J50ZQ	B126J50ZQ2	MD9AB	A223M1D9AB
MD9AVB	A123M1D9AVB	J63ZQ	B127J63ZQ2	J53ZQ	B126J53ZQ2	MD9AVB	A223M1D9AVB
MD9AV2B	A123M1D9AV2B	L1YZQ	A127L11YZQ			MD9AV2B	A223M1D9AV2B
MD9V30B	A123M1D9V30B	L3YZQ	A127L34YZQ	7108J60ZQ	B126J60ZQ2	MD9V30B	A223M1D9V30B
		LYZQ	A127L01YZQ	J63ZQ	B126J63ZQ2		
7101MD9V60B	A123M1D9V60B			L1YZQ	A126L11YZQ	7201MD9V60B	A223M1D9V60B
MDRQ	A123M1DRQ	7105MD9AB	A127M1D9AB	L3YZQ	A126L34YZQ	P1YZQ	A223P11YZQ
MDR2Q	A123M1DR2Q	MD9AVB	A127M1D9AVB			P3YZQ	A223P31YZQ
P1YZQ	A123P11YZQ	MD9AV2B	A127M1D9AV2B	7108MD9AB	A126M1D9AB	P4YZQ	A223P41YZQ
P3YZQ	A123P31YZQ	MD9V30B	A127M1D9V30B	MD9AVB	A126M1D9AVB ①	SCWZQ	A223S1CWZQ
		MD9V60B	A127M1D9V60B	MD9AV2B	A126M1D9AV2B ①		
				MD9V30B	A126M1D9V30B		
7101P4YZQ	A123P41YZQ			MD9V60B	A126M1D9V60B	7201SHZQ	A223S1HZQ
SCWZQ	A123S1CWZQ	7105MDRQ	A127M1DRQ			SPYZQ	A223S1H2ZQP
SHZQ	A123S1HZQ	MDR2Q	A127M1DR2Q			SYCQ	A223S1YCQ
SPYZQ	A123S1H3ZQP	P1YZQ	A127P11YZQ	7108MDRQ	A126M1DRQ	SYWBE	A223S1YWB
SYCQ	A123S1YCQ	P3YZQ	A127P31YZQ				
7101SYWBE	A123S1YWB						
SYZB	A123S1YZB						
SYZQ	A123S1YZQ						

NOTE: Electros witch J11 & J21 Series require different panel cut out than C&K.

Electros witch SC11 and SC12 Series require the use of style B bezel in order to fit in same panel cut out as C&K.

For other combinations of C&K part numbers see Toggle and Rocker Switch Cross References on pages 64 and 65.

① Momentary position opposite that of C&K. See Note ⑦ on page 64.

C&K to Electroswitch Cross Reference

STANDARD MINIATURE SWITCHES

C&K Part No.	Electroswitch Part No.	C&K Part No.	Electroswitch Part No.	C&K Part No.	Electroswitch Part No.	C&K Part No.	Electroswitch Part No.
7201SYZB SYZQ SYZ3QE T1CWYZQ T1ZQ	A223S1YZB A223S1YZQ A223S1Y3ZQ A223T11TWZQ A223T11TZQ	7205SHZQ SPYZQ SYCQ SYWBE SYZB	A227S1HZQ A227S1H3ZQP A227S1YCQ A227S1YWB A227S1YZB	7208SHZQ SPYZQ SYWBE SYZB SYZQ	A226S1HZQ A226S1H3ZQP A226S1YWB A226S1YZB A226S1YZQ	7213J11ZQ J21ZQ J50ZQ J53ZQ J60ZQ	B233J11ZQ22M B233J21ZQ22M B233J50ZQ2 B233J53ZQ2 B233J60ZQ2
7203J1V3B J2V3B J1ZQ J2ZQ J3ZQ	B221J71V3B2 B221J72V3B2 B221J1ZQ2 B221J2ZQ2 B221J3ZQ2	7205SYZQ SYZ3QE	A227S1YZQ A227S1Y3ZQ	7208SYZ3QE	A226S1Y3ZQ	7213J63ZQ L1YZQ L3YZQ LYZQ	B233J63ZQ2 A233L11YZQ A233L34YZQ A233L01YZQ A233M1D9AB
7203J5ZQ J11ZQ J21ZQ J50ZQ J53ZQ	B221J5ZQ2 B221J11ZQ22M B221J21ZQ22M B221J50ZQ2 B221J53ZQ2	7207J1V3B J1ZQ J2V3B J2ZQ J3ZQ	B231J71V3B2 B231J1ZQ2 B231J2V3B2 B231J2ZQ2 B231J3ZQ2	7209MD9AV2B MD9V30B MD9V60B P1YZQ P3YZQ	A234M1D9AV2B A234M1D9V30B A234M1D9V60B A234P11YZQ A234P31YZQ	7213MD9AVB MD9AV2B MD9V30B MD9V60B P1YZQ	A233M1D9AVB ① A233M1D9AV2B ① A233M1D9V30B A233M1D9V60B A233P11YZQ
7203J60ZQ J63ZQ K1ZQ L1YZQ L3YZQ	B221J60ZQ2 B221J63ZQ2 A221K11KZQ A221L11YZQ A221L34YZQ	7207J5ZQ J11ZQ J21ZQ J50ZQ J53ZQ	B231J5ZQ2 B231J11ZQ22M B231J21ZQ22M B231J50ZQ2 B231J53ZQ2	7209P4YZQ SCWZQ SHZQ SPYZQ SYCQ	A234P31YZQ A234S1CWZQ A234S1HZQ A234S1H3ZQP A234S1YCQ	7213P3YZQ P4YZQ SCWZQ SHZQ SPYZQ	A233P31YZQ A233P41YZQ A233S1CWZQ A233S1HZQ A233S1H3ZQP
7203LYZQ MD9AB MD9AVB MD9AV2B MD9V30B	A221L01YZQ A221M1D9AB A221M1D9AVB A221M1D9AV2B A221M1D9V30B	7207J60ZQ J63ZQ L1YZQ L3YZQ LYZQ	B231J60ZQ2 B231J63ZQ2 A231L11YZQ A231L34YZQ A231L01YZQ	7209SYWBE SYZB SYZQ SYZ3QE	A234S1YWB A234S1YZB A234S1YZQ A234S1Y3ZQ	7213SYCQ SYWBE SYZB SYZQ SYZ3QE	A233S1YCQ A233S1YWB A233S1YZB A233S1YZQ A233S1Y3ZQ
7203MD9V60B P1YZQ P3YZQ P4YZQ SCWZQ	A221M1D9V60B A221P11YZQ A221P31YZQ A221P41YZQ A221S1CWZQ	7207MD9AB MD9AVB MD9AV2B MD9V30B MD9V60B	A231M1D9AB A231M1D9AVB ① A231M1D9AV2B ① A231M1D9V30B A231M1D9V60B	7211J1V3B J1ZQ J2V3B J2ZQ J3ZQ	B232J71V3B2 B232J1ZQ2 B232J72V3B2 B232J2ZQ2 B232J3ZQ2	7215J1V3B J1ZQ J2V3B J2ZQ J3ZQ	B235J7AV3B2 B235J1ZQ2 B235J2ZQ2 B235J2ZQ2 B235J3ZQ2
7203SHZQ SPYZQ SYCQ SYWBE SYZB	A221S1HZQ A221S1H3ZQP A221S1YCQ A221S1YWB A221S1YZB	7207P1YZQ P3YZQ P4YZQ SCWZQ SHZQ	A231P11YZQ A231P31YZQ A231P41YZQ A231S1CWZQ A231S1HZQ	7211J5ZQ J11ZQ J21ZQ J50ZQ J53ZQ	B232J5ZQ2 B232J11ZQ22M B232J21ZQ22M B232J50ZQ2 B232J53ZQ2	7215J5ZQ J11ZQ J21ZQ J50ZQ J53ZQ	B235J5ZQ2 B235J11ZQ22M B235J21ZQ22M B235J50ZQ2 B235J53ZQ2
7203SYZQ SYZ3QE T1CWYZQ T1ZQ	A221S1YZQ A221S1Y3ZQ A221T11TWZQ A221T11TZQ	7207SPYZQ SYCQ SYWBE SYZB SYZQ	A231S1H3ZQ A231S1YCQ A231S1WB A231S1YZB A231S1YZQ	7211J60ZQ J63ZQ K1ZQ L1YZQ L3YZQ	B232J60ZQ2 B232J63ZQ2 A232K11KZQ A232L11YZQ A232L34YZQ	7215J60ZQ J63ZQ L1YZQ L3YZQ LYZQ	B235J60ZQ2 B235J63ZQ2 A235L11YZQ A235L34YZQ A235L01YZQ
7205J1V3B J2V3B J1ZQ J2ZQ J3ZQ	B227J71ZQ2 B227J72ZQ2 B227J1ZQ2 B227J2ZQ2 B227J3ZQ2	7208J1V3B J1ZQ J2V3B J2ZQ J3ZQ	B226J71V3B2 B226J1V3B2 B226J2V3B2 B226J1V3B2 B226J3ZQ2	7211LYZQ MD9AB MD9AVB MD9AV2B MD9V30B	A232L01YZQ A232M1D9AB A232M1D9AVB A232M1D9AV2B A232M1D9B30B	7215MD9AB MD9AVB MD9AV2B MD9V30B MD9V60B	A235M1D9AB A235M1D9AVB A235M1D9AV2B A235M1D9V30B A235M1D9V60B
7205J5ZQ J11ZQ J21ZQ J50ZQ J53ZQ	B227J5ZQ2 B227J11ZQ22M B227J21ZQ22M B227J50ZQ2 B227J53ZQ2	7208J5ZQ J11ZQ J21ZQ J50ZQ J53ZQ	B226J5ZQ2 B226J11ZQ22M B226J21ZQ22M B226J50ZQ2 B226J53ZQ2	7211MD9V60B P1YZQ P3YZQ P4YZQ SCWZQ	A232M1D9V60B A232P11YZQ A232P31YZQ A232P41YZQ A232S1CWZQ	7215P1YZQ P3YZQ P4YZQ SCWZQ SHZQ	A235P11YZQ A235P31YZQ A235P41YZQ A235S1CWZQ A235S1HZQ
7205J60ZQ J63ZQ L1YZQ L3YZQ LYZQ	B227J60ZQ2 B227J63ZQ2 A227L11YZQ A227L34YZQ A227L01YZQ	7208J60ZQ J63ZQ L1YZQ L3YZQ LYZQ	B226J60ZQ2 B226J63ZQ2 A226L11YZB A226L34YZQ A226L01YZQ	7211SHZQ P1YZQ SYCQ SYWBE SYZB	A232S1HZQ A232S1H3ZQP A232S1YCQ A232S1YWB A232S1YZB	7215SPYZQ SYCQ SYWBE SYZB SYZQ	A235S1H3ZQ A235S1YCQ A235S1YWB A235S1YZB A235S1YZQ
7205MD9AB MD9AVB MD9AV2B MD9V30B MD9V60B	A227M1D9AB A227M1D9AVB A227M1D9AV2B A227M1D9V30B A227M1D9V60B	7208MD9AB MD9AVB MD9AV2B MD9V30B MD9V60B	A226M1D9AB A226M1D9AVB ① A226M1D9AV2B ① A226M1D9V30B A226M1D9V60B	7211SYZQ SYZ3QE	A232S1YZQ A232S1Y3ZQ	7215SYZ3QE	A235S1Y3ZQ
7206P1YZQ P3YZQ P4YZQ SCWZQ	A227P11YZQ A227P31YZQ A227P41YZQ A227S1CWZQ	7208P1YZQ P3YZQ P3YZQ SCWZQ	A226P11YZQ A226P31YZQ A226P41YZQ A226S1CWZQ	7213J1V3B J1ZQ J2V3B J2ZQ J3ZQ	B233J71V3B2 B233J1ZQ2 B233J72V3B2 B233J2ZQ2 B233J3ZQ2	7301J1ZQ J2ZQ J3ZQ J5ZQ J11ZQ	B323J1ZQ2 B323J2ZQ2 B323J3ZQ2 B323J5ZQ2 B323J11ZQ22M
				7213J5ZQ	B233J5ZQ2	7301J21ZQ K1ZQ	B323J21ZQ22M A323K11KZQ

NOTE: Electroswitch J11 & J21 Series require different panel cut out than C&K.

Electroswitch SC11 and SC12 Series require the use of style B bezel in order to fit in same panel cut out as C&K.

For other combinations of C&K part numbers see Toggle and Rocker Switch Cross References on pages 64 and 65.

① Momentary position opposite that of C&K. See Note ⑦ on page 64.

C&K to Electros witch Cross Reference
STANDARD MINIATURE SWITCHES

C&K Part No.	Electros witch Part No.	C&K Part No.	Electros witch Part No.	C&K Part No.	Electros witch Part No.	C&K Part No.	Electros witch Part No.
7301L1YZQ L3YZQ LYZQ MD9AVB MD9AV2B	A323L11YZQ A323L34YZQ A323L01YZQ A323M1D9AVB A323M1D9AV2B	7307J1ZQ J2ZQ J3ZQ J5ZQ J11ZQ	B331J1ZQ2 B331J2ZQ2 B331J3ZQ2 B331J5ZQ2 B331J11ZQ22M	7403J2ZQ J3ZQ J5ZQ J11ZQ J21ZQ	B421J2ZQ2 B421J3ZQ2 B421J5ZQ2 B421J11ZQ22M B421J21ZQ22M	7407SYZB SYZQ SYZ3QE	A431S1YZB A431S1YZQ A431S1YZ3Q
7301P1YZQ P3YZQ P4YZQ SCWZQ SHZQ	A323P11YZQ A323P31YZQ A323P41YZQ A323S1CWZQ A323S1HZQ	7307J21ZQ L1YZQ L3YZQ LYZQ MD9AVB	B331J21ZQ22M A331L11YZQ A331L34YZQ A331L01YZQ A331M1D9AVB ①	7403K1ZQ L1YZQ L3YZQ LYZQ MD9AVB	A421K11KZQ A421L11YZQ A421L34YZQ A421L01YZQ A421M1D9AVB	7409L1YZQ L3YZQ LYZQ MD9AVB MC9AV2B	A434L11YZQ A434L34YZQ A434L01YZQ A434M1D9AVB A434M1D9AV2B
7301SPYZQ SYCQ SYWBE SYZB SYZQ	A323S1H3ZQP A323S1YCQ A323S1YWB A323S1YZB A323S1YZQ	7307MD9AV2B P1YZQ P3YZQ P3YZQ SCWZQ	A331M1D9AV2B ① A331P11YZQ A331P31YZQ A331P41YZQ A331S1CWZQ	7403MD9AV2B P1YZQ P3YZQ P4YZQ SCWZQ	A421M1D9AV2B A421P11YZQ A421P31YZQ A421P41YZQ A421S1CWZQ	7409P1YZQ P3YZQ P4YZQ SCWZQ SHZQ	A434P11YZQ A434P31YZQ A434P41YZQ A434S1CWZQ A434S1HZQ
7301SYZ3QE T1CWYZQ	A323S1YZ3Q A323T11TWZQ	7307SHZQ SPYZQ SYCQ SYWBE SYZB	A331S1HZQ A331S1H3ZQP A331S1YCQ A331S1YWB A331S1YZB	7403SHZQ SPYZQ SYCQ SYWBE SYZB	A421S1HZQ A421S1H3ZQP A421S1YCQ A421S1YWB A421S1YZB	7409P1YZQ SYCQ SYWBE SYZB SYZQ	A434S1H3ZQP A434S1YCQ A434S1YWB A434S1YZB A434S1YZQ
7303J1ZQ J2ZQ J3ZQ J5ZQ J11ZQ	B321J1ZQ2 B321J2ZQ2 B321J3ZQ2 B321J5ZQ2 B321J11ZQ22M	7307SYZQ SYZ3QE	A331S1YZQ A331S1YZ3Q	7403SYZQ SYZ3QE	A421S1YZQ A421S1YZ3Q	7411J1ZQ J2ZQ J3ZQ J5ZQ J11ZQ	B432J1ZQ2 B432J2ZQ2 B432J3ZQ2 B432J5ZQ2 B432J11ZQ22M
7303J21ZQ K1ZQ L1YZQ L3YZQ LYZQ	B321J21ZQ22M A321K11KZQ A321L11YZQ A321L34YZQ A321L01YZQ	7309L1YZQ L3YZQ LYZQ MD9AVB MD9AV2B	A334L11YZQ A334L34YZQ A334L01YZQ A334M1D9AVB A334M1D9AV2B	7405J1ZQ J2ZQ J3ZQ J5ZQ J11ZQ	B427J1ZQ2 B427J2ZQ2 B427J3ZQ2 B427J5ZQ2 B427J11ZQ22M	7411J21ZQ L1YZQ L3YZQ LYZQ MD9AVB	B432J21ZQ22M A432L11YZQ A432L34YZQ A432L01YZQ A432M1D9AVB
7303MD9AVB MD9AV2B P1YZQ P3YZQ P4YZQ	A321M1D9AVB A321M1D9AV2B A321P11YZQ A321P31YZQ A321P41YZQ	7309P1YZQ P3YZQ P4YZQ SCWZQ SHZQ	A334P11YZQ A334P31YZQ A334P41YZQ A334S1CWZQ A334S1HZQ	7405J21ZQ L1YZQ L3YZQ LYZQ MD9AVB	B427J21ZQ22M A427L11YZQ A427L34YZQ A427L01YZQ A427M1D9AVB	7411MD9AV2B P1YZQ P3YZQ P4YZQ SCWZQ	A432M1D9AV2B A432P11YZQ A432P31YZQ A432P41YZQ A432S1CWZQ
7303SCWZQ SHZQ SPYZQ SYCQ SYWBE	A321S1CWZQ A321S1HZQ A321S1H3ZQP A321S1YCQ A321S1YWB	7309SPYZQ SYCQ SYWBE SYZB SYZQ	A334S1H3ZQP A334S1YCQ A334S1YWB A334S1YZB A334S1YZQ	7405MD9AV2B P1YZQ P3YZQ P4YZQ SCWZQ	A427M1D9AV2B A427P11YZQ A427P31YZQ A427P41YZQ A427S1CWZQ	7411SHZQ SPYZQ SYCQ SYWBE SYZB	A432S1HZQ A432S1H3ZQP A432S1YCQ A432S1YWB A432S1YZB
7303SYZB SYZQ SYZ3QE	A321S1YZB A321S1YZQ A321S1YZ3Q	7309SYZ3QE	A334S1YZ3Q	7405SHZQ SPYZQ SYCQ SYWBE SYZB	A427S1HZQ A427S1H3ZQP A427S1YCQ A427S1YWB A427S1YZB	7411SYZQ SYZ3QE	A432S1YZQ A432S1YZ3Q
7305J1ZQ J2ZQ J3ZQ J5ZQ J11ZQ	B327J1ZQ2 B327J2ZQ2 B327J3ZQ2 B327J5ZQ2 B327J11ZQ22M	7401J1ZQ J2ZQ J3ZQ J5ZQ J11ZQ	B423J1ZQ2 B423J2ZQ2 B423J3ZQ2 B423J5ZQ2 B423J11ZQ22M	7405SYZQ SYZ3QE	A427S1YZQ A427S1YZ3Q	7413J1ZQ J2ZQ J3ZQ J5ZQ J11ZQ	B433J1ZQ2 B433J2ZQ2 B433J3ZQ2 B433J5ZQ2 B433J11ZQ22M
7305J21ZQ L1YZQ L3YZQ LYZQ MD9AVB	B327J21ZQ22M A321L11YZQ A321L34YZQ A321L01YZQ A321M1D9AVB	7401MD9AVB MD9AV2B P1YZQ P3YZQ P4YZQ	B423J21ZQ22M A423K11KZQ A423L11YZQ A423L34YZQ A423L01YZQ	7407J1ZQ J2ZQ J3ZQ J5ZQ J11ZQ	B431J1ZQ2 B431J2ZQ2 B431J3ZQ2 B431J5ZQ2 B431J11ZQ22M	7413J21ZQ L1YZQ L3YZQ LYZQ MD9AVB	B433J21ZQ22M A433L11YZQ A433L34YZQ A433L01YZQ A433M1D9AVB ①
7305MD9AV2B P1YZQ P3YZQ P4YZQ SCWZQ	A321M1D9AV2B A321P11YZQ A321P31YZQ A321P41YZQ A321S1CWZQ	7401SCWZQ SHZQ SPYZQ SYCQ SYWBE	A423S1CWZQ A423S1HZQ A423S1H3ZQP A423S1YCQ A423S1YWB	7407MD9AV2B P1YZQ P3YZQ P4YZQ SCWZQ	A431M1D9AVB ① A431P11YZQ A431P31YZQ A431P41YZQ A431S1CWZQ	7413MD9AV2B P1YZQ P3YZQ P4YZQ SCWZQ	A433M1D9AV2B ① A433P11YZQ A433P31YZQ A433P41YZQ A433S1CWZQ
7305SHZQ SPYZQ SYCQ SYWBE SYZB	A321S1HZQ A321S1H3ZQ A321S1YCQ A321S1YWB A321S1YZB	7401SYZB SYZQ SYZ3QE T1CWYZQ	A423S1YZB A423S1YZQ A423S1YZ3Q A423T11TWZQ	7407SHZQ SPYZQ SYCQ SYWBE	A431S1HZQ A431S1H3ZQP A431S1YCQ A431S1YWB	7413SHZQ SPYZQ SYCQ SYWBE SYZB	A433S1HZQ A433S1H3ZQP A433S1YCQ A433S1YWB A433S1YZB
7305SYZQ SYZ3QE	A321S1YZQ A321S1YZ3Q	7403J1ZQ	B421J1ZQ2			7413SYZQ	A433S1YZQ

NOTE: Electros witch J11 & J21 Series require different panel cut out than C&K.

Electros witch SC11 and SC12 Series require the use of style B bezel in order to fit in same panel cut out as C&K.

For other combinations of C&K part numbers see Toggle and Rocker Switch Cross References on pages 64 and 65.

① Momentary position opposite that of C&K. See Note ⑦ on page 64.

C&K to Electros witch Cross Reference

STANDARD MINIATURE SWITCHES

C&K Part No.	Electros witch Part No.	C&K Part No.	Electros witch Part No.	C&K Part No.	Electros witch Part No.	C&K Part No.	Electros witch Part No.
7413SYZ3QE	A43S1Y23Q	7982 White	W-KN-18A	8125ABE	PS9-100B	8221V4GE	PS81-200G
7415J1ZQ	B435J1ZQ2	7982 Black	W-KN-18	AV2BE	PS11-100B	V6GE	PS82-200G
J2ZQ	B435J2ZQ2	7982 Red	W-KN-18B	HCBE	PS2-100B	V7GE	PS83-200G
J3ZQ	B435J3ZQ2			HZBE	PS1-100B	V40GE	PS71-200G
J5ZQ	B435J5ZQ2	8025	SW2AA10	V3CBE	PS8-100B	V60GE	PS72-200G
J11ZQ	B435J11ZQ22M	8121AGE	PS9-100G				
7415J21ZQ	B435J21ZQ22M	AV2GE	PS11-100G	8125V4BE	PS81-100B	8221V70GE	PS73-200G
L1YZQ	A435L11YZQ	D8R2Q	PS5-100Q	V6BE	PS82-100B		
L3YZQ	A435L34YZQ	D8RQ	PS6-100Q	V7BE	PS83-100B	8225ABE	PS9-200B
LYZQ	A435L01YZQ			V30CBE	PS7-100B	AV2BE	PS11-200B
MD9AVB	A435M1D9AVB	8121HCQE	PS2-100Q	V40BE	PS71-100B	HCBE	PS2-200B
		HZQE	PS1-100Q			HZBE	PS1-200B
		J81CBE	PS16-1122B	8125V60BE	PS72-100B	V3CBE	PS8-200B
		J81CQE	PS16-1122Q	V70BE	PS73-100B		
		J81ZBE	PS14-1122B				
7415MD9AV2B	A435M1D9AV2B			8161SHZQ	PB-123	8225V4BE	PS81-200B
P1YZQ	A435P11YZQ			8168SHZQ	PB-126	V6BE	PS82-200B
P3YZQ	A435P31YZQ					V7BE	PS83-200B
P4YZQ	A435P41YZQ	8121J81ZQE	PS14-1122Q	8221AGE	PS9-200G	V30CBE	PS7-200B
SCWZQ	A435S1CWZQ	J82CBE	PS16-1124B	AV2GE	PS11-200G	V40BE	PS71-200B
		J82CQE	PS16-1124Q	HCQE	PS2-200Q		
		J82ZBE	PS14-1124B	HZQE	PS1-200Q	8225V60BE	PS72-200B
7415SHZQ	A435S1HZQ	J82ZQE	PS14-1124Q	J81CBE	PS16-2122B	V70BE	PS73-200B
SPYZQ	A435S1H3ZQP						
SYCQ	A435S1YCQ	8121J83CBE	PS17-1122B	8221J81CQE	PS16-2122Q	8632ZQ	SA1BW20
SYWBE	A435S1YWB	J83CQE	PS17-1122Q	J81ZBE	PS14-2122B		
SYZB	A435S1YZB	J83ZBE	PS15-1122B	J81ZQE	PS14-2122Q	8633ZQ	SA1BW20
		J83ZQE	PS15-1122Q	J82CBE	PS16-2124B		
7415SYZQ	A435S1YZQ	J84CBE	PS17-1124B	J82CQE	PS16-2124Q		
SYZ3QE	A435S1YZ3Q						
				8221J82ZBE	PS14-2124B		
7527 White	W-KN-17A	8121J84CQE	PS17-1124Q	J82ZQE	PS14-2124Q		
7527 Black	W-KN-17	J84ZBE	PS15-1124B	J83CBE	PS17-2122B		
7527 Red	W-KN-17B	J84ZQE	PS15-1124Q	J83CQE	PS17-2122Q		
7572	W-RI-16	V4GE	PS81-100G	J83ZBE	PS15-2122B		
7752	15-1047	V6GE	PS82-100G				
				8221J83ZQE	PS15-2122Q		
7785	W-TL-124			J84CBE	PS17-2124B		
7890 White	W-BZ-12A	8131V7GE	PS83-100G	J83CQE	PS17-2124Q		
7890 Black	W-BZ-12	V40GE	PS71-100G	J84ZBE	PS15-2124B		
7890 Red	W-BZ-12B	V60GE	PS72-100G	J84ZQE	PS15-2124Q		
7969	W-U-12	V70GE	PS73-100G	J84ZBE	PS15-2124Q		

NOTE: Electros witch J11 & J21 Series require different panel cut out than C&K.
 Electros witch SC11 and SC12 Series require the use of style B bezel in order to fit in same panel cut out as C&K.
 For other combinations of C&K part numbers see Toggle and Rocker Switch Cross References on pages 64 and 65.

C&K to Electros witch Cross Reference

WASHABLE MINIATURE SWITCHES

C&K Part No.	Electros witch Part No.	C&K Part No.	Electros witch Part No.	C&K Part No.	Electros witch Part No.	C&K Part No.	Electros witch Part No.
E101J1AB	WR123J71AB2	E103J1AB	WR121J71AB2	E103SD1V30B	WT121S1D1V30B	E105SD1V30B	WT127S1D1V30B
J1AV2B	WR123J71AV2B2	J1AV2B	WR121J71AV2B2	E103SD1ZQ	WT121S1D1ZQ	SD1ZQ	WT127S1D1ZQ
J1V3B	WR123J71V3B2	J1V3B	WR121J71V3B2	E103SYZQ	WT121S1YZQ	SYZQ	WT127S1YZQ
J1ZQ	WR123J1ZQ2	J1ZQ	WR121J1ZQ2				
J2AB	WP123J72AB2	J2AB	WP121J72AB2	E105J1AB	WR127J71AB2	E107J1AB	WR131J71AB2
				J1AV2B	WR127J71AV2B2	J1AV2B	WR131J71AV2B2 ①
E101J2AV2B	WP123J7SAV2B2	E103J2AV2B	WP121J7219V2B2	J1V3B	WR127J71V3B2	J1V3B	WR131J71V3B2
J2V3B	WP123J72V3B2	J2V3B	WP121J72V3B2	J1ZQ	WR127J1ZQ2	J1ZQ	WR131J1ZQ2
J2ZQ	WP123J2ZQ2	J2ZQ	WP121J2ZQ2	J2AB	WP127J72AB2	J2AB	WP131J72AB2
L3D1ZQ	WT123L134D1ZQ	L3D1ZQ	WT121L34D1ZQ	E105J2AV2B	WP127J72AV2B2	E107J2AV2B	WP131J72AV2B2 ①
L3YZQ	WT123L34YZQ	L3YZQ	WT121L34YZQ	J2V3B	WP127J72V3B2	J2V3B	WP131J72V3B2
				J2ZQ	WP127J2ZQ2	J2ZQ	WP131J2ZQ2
E101MD1AB	WT123M1D1AB	E103MD1AB	WT121M1D1AB	L3D1ZQ	WT127L34D1ZQ	L3D1ZQ	WT131L34D1ZQ
MD1AV2B	WT123M1D1AV2B	MD1AV2B	WT121M1D1AV2B	L3YZQ	WT127L34YZQ	L3YZQ	WT131L34YZQ
MD1V30B	WT123M1D1V30B	MD1V30B	WT121M1D1V30B				
MD1ZQ	WT123M1D1ZQ	MD1ZQ	WT121M1D1ZQ	E105MD1AB	WT127M1D1AB	E107MD1AB	WT131M1D1AB
MYZQ	WT123M1YZQ	MYAB	WT121M1YAB	MD1AV2B	WT127M1D1AV2B	MD1AV2B	WT131M1D1AV2B ①
				MD1V30B	WT127M1D1V30B	MD1V30B	WT131M1D1V30B
E101SD1AB	WT123S1D1AB	E103MYAV2B	WT121M1YAV2B	MD1ZQ	WT127M1D1ZQ	MD1ZQ	WT131M1D1ZQ
SD1AV2B	WT123S1D1AV2B	MYV30B	WT121M1YV30B	MYZQ	WT127M1YZQ	MYZQ	WT131M1YZQ
SD1V30B	WT123S1D1V30B	MYZQ	WT121M1YZQ				
SD1ZQ	WT123S1D1ZQ	SD1AB	WT121S1D1AB	E105SD1AB	WT127S1D1AB	E107SD1AB	WT131S1D1AB
ZQ	WT123S1YZQ	SD1AV2B	WT121S1D1AV2B	SD1AV2B	WT127S1D1AV2B	SD1AV2B	WT131S1D1AV2B ①

NOTE: For other combinations of C&K part numbers see Washable Toggle and Rocker Switch Cross References on page 66.
 ① Momentary position opposite that of C&K. See Notes ⑤ or ⑦ on page 66.

C&K to Electroswitch Cross Reference
STANDARD MINIATURE SWITCHES

C&K Part No.	Electroswitch Part No.	C&K Part No.	Electroswitch Part No.	C&K Part No.	Electroswitch Part No.
E107SD1V30B SD1ZQ SYZQ	WT131S1D1V30B WT131S1D1ZQ WT131S1YZQ	E205J2AV2B J2V3B J2ZQ L3D1ZQ L3YZQ	WP227J72AV2B2 WP227J72V3B2 WP227J2ZQ2 WT227L34D1ZQ WT227L34YZQ	E211MD1AB MD1AV2B MD1V30B MD1ZQ MYZQ	WT232M1D1AB WT232M1D1AV2B WT232M1D1V30B WT232M1D1ZQ WT232M1YZQ
E108J1AB J1AV2B J1V3B J1ZQ J2AB	WR126J71AB2 WR126J71AV2B2 ❶ WR126J71V3B2 WR126J71ZQ2 WP126J72AB2	E205MD1AB MD1AV2B MD1V30B MD1ZQ MYZQ	WT227M1D1AB WT227M1D1AV2B WT227M1D1V30B WT227M1D1ZQ WT227M1YZQ	E211SD1AB SD1AV2B SD1V30B SD1ZQ SYZQ	WT232S1D1AB WT232S1D1AV2B WT232S1D1V30B WT232S1D1ZQ WT232S1YZQ
E108J2AV2B J2V3B J2ZQ L3D1ZQ L3YZQ	WP126J72AV2B2 ❶ WP126J72V3B2 WP126J2ZQ2 WT126L34D1ZQ WT126L34YZQ	E205SD1AB SD1AV2B SD1V30B SD1ZQ SYZQ	WT227S1D1AB WT227S1D1AV2B WT227S1D1V30B WT227S1D1ZQ WT227S1YZQ	E215J1AB J1AV2B J1V3B J1ZQ J2AB	WR235J71AB2 WR235J71AV2B2 WR235J71V3B2 WR235J1ZQ2 WP235J72AB2
E108MD1AB MD1AV2B MD1V30B MD1ZQ MYZQ	WT126M1D1AB WT126M1D1AV2B ❶ WT126M1D1V30B WT126M1D1ZQ WT126M1YZQ	E207J1AB J1AV2B J1V3B J1ZQ J2AB	WR231J71AB2 WR231J71AV2B2 ❶ WR231J71V3B2 WR231J1ZQ2 WP231J72AB2	E215J2AV2B J2V3B J2ZQ L3D1ZQ L3YZQ	WP235J72AV2B2 WP235J72V3B2 WP235J2ZQ2 WT235L34D1ZQ WT235L34YZQ
E108SD1AB SD1AV2B SD1V30B SD1ZQ SYZQ	WT126S1D1AB WT126S1D1AV2B ❶ WT126S1D1V30B WT126S1D1ZQ WT126S1YZQ	E207J2AV2B J2V3B J2ZQ L3D1ZQ L3YZQ	WP231J72AV2B2 ❶ WP231J72V3B2 WP231J2ZQ2 WT231L34D1ZQ WT231L34YZQ	E215MD1AB MD1AV2B MD1V30B MD1ZQ MYZQ	WT235M1D1AB WT235M1D1AV2B WT235M1D1V30B WT235M1D1ZQ WT235M1YZQ
E201J1AB J1AV2B J1V3B J1ZQ J2AB	WR223J71AB2 WR223J71AV2B2 WR223J71V3B2 WR223J1ZQ2 WP223J72AB2	E207MD1AB MD1AV2B MD1V30B MD1ZQ MYZQ	WT231M1D1AB WT231M1D1AV2B ❶ WT231M1D1V30B WT231M1D1ZQ WT231M1YZQ	E215SD1AB SD1AV2B SD1V30B SD1ZQ SYZQ	WT235S1D1AB WT235S1D1AV2B WT235S1D1V30B WT235S1D1ZQ WT235S1YZQ
E201J2AV2B J2V3B J2ZQ L3D1ZQ L3YZQ	WP223J72AV2B2 WP223J72V3B2 WP223J2ZQ2 WT223L34D1ZQ WT223L34YZQ	E207SD1AB SD1AV2B SD1V30B SD1ZQ SYZQ	WT231S1D1AB WT231S1D1AV2B ❶ WT231S1D1V30B WT231S1D1ZQ WT231S1YZQ		
E201MD1AB MD1AV2B MD1V30B MD1ZQ MYZQ	WT223M1D1AB WT223M1D1AV2B WT223M1D1V30B WT223M1D1ZQ WT223M1YZQ	E208J1AB J1AV2B J1V3B J1ZQ J2AB	WR226J71AB2 WR226J71AV2B2 ❶ WR226J71V3B2 WR226J71ZQ2 WP226J72AB2		
E201SD1AB SD1AV2B SD1V30B SD1ZQ SYZQ	WT223S1D1AB WT223S1D1AV2B WT223S1D1V30B WT223S1D1ZQ WT223SZ1YZQ	E209J2AV2B J2V3B J2ZQ L3D1ZQ L36ZQ	WR226J72AV2B2 ❶ WR226J72V3B2 WP226J2ZQ2 WT226L34D1ZQ WT226L34YZQ		
E203J1AB J1AV2B J1V3B J1ZQ J2AB	WR221J71AB2 WR221J71AV2B2 WR221J71V3B2 WR221J1ZQ2 WP221J72AB2	E208MD1AB MD1AV2B MD1V30B MD1ZQ MYZQ	WT226M1D1AB WT226M1D1AV2B ❶ WT226M1D1V30B WT226M1D1ZQ WT226M1YZQ		
E203J2AV2B J2V3B J2ZQ L3D1ZQ L3YZQ	WP221J72AV2B2 WP221J72V3B2 WP221J2ZQ WT221L34D1ZQ WT221L34YZQ	E208SD1AB SD1AV2B SD1V30B SD1ZQ SYZQ	WT226S1D1AB WT226S1D1AV2B ❶ WT226S1D1V30B WT226S1D1ZQ WT226S1YZQ		
E203MD1AB MD1AV2B MD1V30B MD1ZQ MYZQ	WT221M1D1AB WT221M1D1AV2B WT221M1D1V30B WT221M1D1ZQ WT221M1YZQ	E211J1AB J1AV2B J1V3B J1ZQ J2AB	WR232J71AB2 WR232J71AV2B2 WR232J71V3B2 WR232J1ZQ2 WP232J72AB2		
E203SD1AB SD1AV2B SD1V30B SD1ZQ SYZQ	WT221S1D1AB WT221S1D1AV2B WT221S1D1V30B WT221S1D1ZQ WT221S1YZQ	E211J2AV2B J2V3B J2ZQ L3D1ZQ L3YZQ	WP232J72AV2B2 WP232J72V3B2 WP232J2ZQ2 WT232L34D1ZQ WT232L34YZQ		
E205J1AB J1AV2B J1V3B J1ZQ J2AB	WR227J71AB2 WR227J71AV2B2 WR227J71V3B2 WR227J1ZQ2 WP227J72AB2				

NOTE: For other combinations of C&K part numbers see Washable Toggle and Rocker Switch Cross References on page 66.

❶ Momentary position opposite that of C&K. See Notes ❷ or ❸ on page 66.

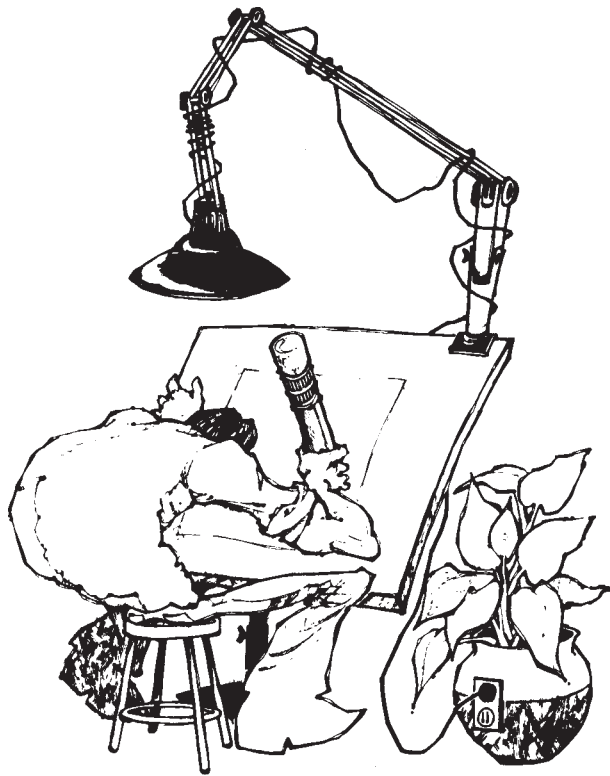

Designers' Choice...

This catalog represents a broad selection of popular switches, associated hardware and accessories available through a national network of Authorized Distributors.

But our capabilities extend well beyond the standard — into the "special" and even the "proprietary". The point is — if you haven't found what you're looking for in these standard selections — we'll build it for you.

Like one of these...

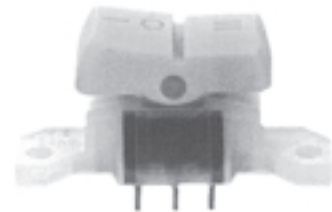
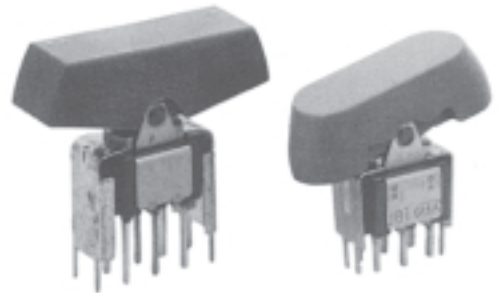
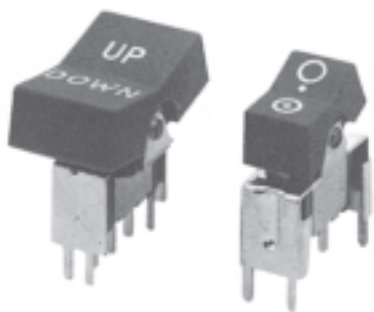

A whole lot more than prompt and field help. There's proven



availability, quality assurance, design innovation, too!

Компания «Океан Электроники» предлагает заключение долгосрочных отношений при поставках импортных электронных компонентов на взаимовыгодных условиях!

Наши преимущества:

- Поставка оригинальных импортных электронных компонентов напрямую с производств Америки, Европы и Азии, а так же с крупнейших складов мира;
- Широкая линейка поставок активных и пассивных импортных электронных компонентов (более 30 млн. наименований);
- Поставка сложных, дефицитных, либо снятых с производства позиций;
- Оперативные сроки поставки под заказ (от 5 рабочих дней);
- Экспресс доставка в любую точку России;
- Помощь Конструкторского Отдела и консультации квалифицированных инженеров;
- Техническая поддержка проекта, помощь в подборе аналогов, поставка прототипов;
- Поставка электронных компонентов под контролем ВП;
- Система менеджмента качества сертифицирована по Международному стандарту ISO 9001;
- При необходимости вся продукция военного и аэрокосмического назначения проходит испытания и сертификацию в лаборатории (по согласованию с заказчиком);
- Поставка специализированных компонентов военного и аэрокосмического уровня качества (Xilinx, Altera, Analog Devices, Intersil, Interpoint, Microsemi, Actel, Aeroflex, Peregrine, VPT, Syfer, Eurofarad, Texas Instruments, MS Kennedy, Miteq, Cobham, E2V, MA-COM, Hittite, Mini-Circuits, General Dynamics и др.);

Компания «Океан Электроники» является официальным дистрибьютором и эксклюзивным представителем в России одного из крупнейших производителей разъемов военного и аэрокосмического назначения «**JONHON**», а так же официальным дистрибьютором и эксклюзивным представителем в России производителя высокотехнологичных и надежных решений для передачи СВЧ сигналов «**FORSTAR**».



JONHON

«**JONHON**» (основан в 1970 г.)

Разъемы специального, военного и аэрокосмического назначения:

(Применяются в военной, авиационной, аэрокосмической, морской, железнодорожной, горно- и нефтедобывающей отраслях промышленности)

«**FORSTAR**» (основан в 1998 г.)

ВЧ соединители, коаксиальные кабели,
кабельные сборки и микроволновые компоненты:

(Применяются в телекоммуникациях гражданского и специального назначения, в средствах связи, РЛС, а так же военной, авиационной и аэрокосмической отраслях промышленности).



Телефон: 8 (812) 309-75-97 (многоканальный)

Факс: 8 (812) 320-03-32

Электронная почта: ocean@oceanchips.ru

Web: <http://oceanchips.ru/>

Адрес: 198099, г. Санкт-Петербург, ул. Калинина, д. 2, корп. 4, лит. А