



# MICROCHIP MCP102/103/121/131

## Micropower Voltage Supervisors

### Features

- Ultra low supply current: 1.75  $\mu\text{A}$  (steady-state max.)
- Precision monitoring options of:
  - 1.90V, 2.32V, 2.63V, 2.93V, 3.08V, 4.38V and 4.63V
- Resets microcontroller in a power-loss event
- $\overline{\text{RST}}$  pin (Active-low):
  - **MCP121**: Active-low, open-drain
  - **MCP131**: Active-low, open-drain with internal pull-up resistor
  - **MCP102** and **MCP103**: Active-low, push-pull
- Reset Delay Timer (120 ms delay, typ.)
- Available in SOT23-3, TO-92 and SC-70 packages
- Temperature Range:
  - Extended:  $-40^{\circ}\text{C}$  to  $+125^{\circ}\text{C}$  (except **MCP1XX-195**)
  - Industrial:  $-40^{\circ}\text{C}$  to  $+85^{\circ}\text{C}$  (**MCP1XX-195** only)
- Pb-free devices

### Applications

- Critical Microcontroller and Microprocessor Power-monitoring Applications
- Computers
- Intelligent Instruments
- Portable Battery-powered Equipment

### General Description

The MCP102/103/121/131 are voltage supervisor devices designed to keep a microcontroller in reset until the system voltage has reached and stabilized at the proper level for reliable system operation. Table 1 shows the available features for these devices.

**TABLE 1: DEVICE FEATURES**

Device	Output		Reset Delay (typ)	Package Pinout (Pin # 1, 2, 3)	Comment
	Type	Pull-up Resistor			
<b>MCP102</b>	Push-pull	No	120 ms	$\overline{\text{RST}}$ , $V_{\text{DD}}$ , $V_{\text{SS}}$	
<b>MCP103</b>	Push-pull	No	120 ms	$V_{\text{SS}}$ , $\overline{\text{RST}}$ , $V_{\text{DD}}$	
<b>MCP121</b>	Open-drain	External	120 ms	$\overline{\text{RST}}$ , $V_{\text{DD}}$ , $V_{\text{SS}}$	
<b>MCP131</b>	Open-drain	Internal ( $\sim 95 \text{ k}\Omega$ )	120 ms	$\overline{\text{RST}}$ , $V_{\text{DD}}$ , $V_{\text{SS}}$	
<b>MCP111</b>	Open-drain	External	No	$V_{\text{OUT}}$ , $V_{\text{SS}}$ , $V_{\text{DD}}$	See <b>MCP111/112</b> Data Sheet (DS21889)
<b>MCP112</b>	Push-Pull	No	No	$V_{\text{OUT}}$ , $V_{\text{SS}}$ , $V_{\text{DD}}$	See <b>MCP111/112</b> Data Sheet (DS21889)

### Package Types



### Block Diagram



# MCP102/103/121/131

## 1.0 ELECTRICAL CHARACTERISTICS

### Absolute Maximum Ratings†

$V_{DD}$ .....	7.0V
Input current ( $V_{DD}$ ) .....	10 mA
Output current ( $\overline{RST}$ ) .....	10 mA
Rated Rise Time of $V_{DD}$ .....	100V/ $\mu$ s
All inputs and outputs (except $\overline{RST}$ ) w.r.t. $V_{SS}$ .....	-0.6V to ( $V_{DD} + 1.0V$ )
$\overline{RST}$ output w.r.t. $V_{SS}$ .....	-0.6V to 13.5V
Storage temperature .....	-65°C to +150°C
Ambient temp. with power applied .....	-40°C to +125°C
Maximum Junction temp. with power applied .....	150°C
ESD protection on all pins .....	$\geq 2$ kV

† **Notice:** Stresses above those listed under “Maximum Ratings” may cause permanent damage to the device. This is a stress rating only and functional operation of the device at those or any other conditions above those indicated in the operational listings of this specification is not implied. Exposure to maximum rating conditions for extended periods may affect device reliability.

### DC CHARACTERISTICS

Electrical Specifications: Unless otherwise indicated, all limits are specified for: $V_{DD} = 1V$ to 5.5V, $R_{PU} = 100$ k $\Omega$ (MCP121 only), $T_A = -40^\circ\text{C}$ to $+125^\circ\text{C}$ .							
Parameters	Sym	Min	Typ	Max	Units	Conditions	
Operating Voltage Range	$V_{DD}$	1.0	—	5.5	V		
Specified $V_{DD}$ Value to $\overline{RST}$ low	$V_{DD}$	1.0	—		V	$I_{\overline{RST}} = 10$ uA, $V_{\overline{RST}} < 0.2V$	
Operating Current	MCP102, MCP103, MCP121	$I_{DD}$	—	< 1	1.75	$\mu$ A	Reset Power-up Timer ( $t_{RPU}$ ) Inactive
			—	—	20.0	$\mu$ A	Reset Power-up Timer ( $t_{RPU}$ ) Active
	MCP131	$I_{DD}$	—	< 1	1.75	$\mu$ A	$V_{DD} > V_{TRIP}$ and Reset Power-up Timer ( $t_{RPU}$ ) Inactive
			—	—	75	$\mu$ A	$V_{DD} < V_{TRIP}$ and Reset Power-up Timer ( $t_{RPU}$ ) Inactive ( <b>Note 3</b> )
			—	—	90	$\mu$ A	Reset Power-up Timer ( $t_{RPU}$ ) Active ( <b>Note 4</b> )

- Note 1:** Trip point is  $\pm 1.5\%$  from typical value.  
**Note 2:** Trip point is  $\pm 2.5\%$  from typical value.  
**Note 3:**  $\overline{RST}$  output is forced low. There is a current through the internal pull-up resistor.  
**Note 4:** This includes the current through the internal pull-up resistor and the reset power-up timer.  
**Note 5:** This specification allows this device to be used in PIC<sup>®</sup> microcontroller applications that require In-Circuit Serial Programming<sup>™</sup> (ICSP<sup>™</sup>) (see device-specific programming specifications for voltage requirements). This specification DOES NOT allow a continuous high voltage to be present on the open-drain output pin ( $V_{OUT}$ ). The total time that the  $V_{OUT}$  pin can be above the maximum device operational voltage (5.5V) is 100s. Current into the  $V_{OUT}$  pin should be limited to 2 mA and it is recommended that the device operational temperature be maintained between 0°C to 70°C (+25°C preferred). For additional information, please refer to Figure 2-33.  
**Note 6:** This parameter is established by characterization and not 100% tested.

# MCP102/103/121/131

## DC CHARACTERISTICS (CONTINUED)

<b>Electrical Specifications:</b> Unless otherwise indicated, all limits are specified for: $V_{DD} = 1V$ to $5.5V$ , $R_{PU} = 100\text{ k}\Omega$ (MCP121 only), $T_A = -40^\circ\text{C}$ to $+125^\circ\text{C}$ .							
Parameters		Sym	Min	Typ	Max	Units	Conditions
V <sub>DD</sub> Trip Point	MCP1XX-195	V <sub>TRIP</sub>	1.872	1.900	1.929	V	T <sub>A</sub> = +25°C (Note 1)
			1.853	1.900	1.948	V	T <sub>A</sub> = -40°C to +85°C (Note 2)
	MCP1XX-240		2.285	2.320	2.355	V	T <sub>A</sub> = +25°C (Note 1)
			2.262	2.320	2.378	V	Note 2
	MCP1XX-270		2.591	2.630	2.670	V	T <sub>A</sub> = +25°C (Note 1)
			2.564	2.630	2.696	V	Note 2
	MCP1XX-300		2.886	2.930	2.974	V	T <sub>A</sub> = +25°C (Note 1)
			2.857	2.930	3.003	V	Note 2
	MCP1XX-315		3.034	3.080	3.126	V	T <sub>A</sub> = +25°C (Note 1)
			3.003	3.080	3.157	V	Note 2
	MCP1XX-450		4.314	4.380	4.446	V	T <sub>A</sub> = +25°C (Note 1)
			4.271	4.380	4.490	V	Note 2
MCP1XX-475	4.561	4.630	4.700	V	T <sub>A</sub> = +25°C (Note 1)		
	4.514	4.630	4.746	V	Note 2		
V <sub>DD</sub> Trip Point Tempco		T <sub>TPCO</sub>	—	±100	—	ppm/°C	
Threshold Hysteresis (min. = 1%, max = 6%)	MCP1XX-195	V <sub>HYS</sub>	0.019	—	0.114	V	T <sub>A</sub> = +25°C
	MCP1XX-240		0.023	—	0.139	V	
	MCP1XX-270		0.026	—	0.158	V	
	MCP1XX-300		0.029	—	0.176	V	
	MCP1XX-315		0.031	—	0.185	V	
	MCP1XX-450		0.044	—	0.263	V	
	MCP1XX-475		0.046	—	0.278	V	
RST Low-level Output Voltage		V <sub>OL</sub>	—	—	0.4	V	I <sub>OL</sub> = 500 $\mu$ A, V <sub>DD</sub> = V <sub>TRIP(MIN)</sub>
RST High-level Output Voltage (MCP102 and MCP103 only)		V <sub>OH</sub>	V <sub>DD</sub> - 0.6	—	—	V	I <sub>OH</sub> = 1 mA, For MCP102/MCP103 only (push-pull output)
Internal Pull-up Resistor (MCP131 only)		R <sub>PU</sub>	—	95	—	k $\Omega$	V <sub>DD</sub> = 5.5V
Open-drain High Voltage on Output (MCP121 only)		V <sub>ODH</sub>	—	—	13.5 <sup>(5)</sup>	V	V <sub>DD</sub> = 3.0V, Time voltage > 5.5V applied $\leq$ 100s, current into pin limited to 2 mA, 25°C operation recommended (Note 5, Note 6)
Open-drain Output Leakage Current (MCP121 only)		I <sub>OD</sub>	—	0.1	—	$\mu$ A	

- Note 1:** Trip point is  $\pm 1.5\%$  from typical value.
- Note 2:** Trip point is  $\pm 2.5\%$  from typical value.
- Note 3:** RST output is forced low. There is a current through the internal pull-up resistor.
- Note 4:** This includes the current through the internal pull-up resistor and the reset power-up timer.
- Note 5:** This specification allows this device to be used in PIC<sup>®</sup> microcontroller applications that require In-Circuit Serial Programming<sup>™</sup> (ICSP<sup>™</sup>) (see device-specific programming specifications for voltage requirements). This specification DOES NOT allow a continuous high voltage to be present on the open-drain output pin (V<sub>OUT</sub>). The total time that the V<sub>OUT</sub> pin can be above the maximum device operational voltage (5.5V) is 100s. Current into the V<sub>OUT</sub> pin should be limited to 2 mA and it is recommended that the device operational temperature be maintained between 0°C to 70°C (+25°C preferred). For additional information, please refer to Figure 2-33.
- Note 6:** This parameter is established by characterization and not 100% tested.

# MCP102/103/121/131



FIGURE 1-1: Timing Diagram.

## AC CHARACTERISTICS

**Electrical Specifications:** Unless otherwise indicated, all limits are specified for:  $V_{DD} = 1V$  to  $5.5V$ ,  $R_{PU} = 100\text{ k}\Omega$  (MCP121 only),  $T_A = -40^\circ\text{C}$  to  $+125^\circ\text{C}$ .

Parameters	Sym	Min	Typ	Max	Units	Conditions
$V_{DD}$ Detect to $\overline{RST}$ Inactive	$t_{RPU}$	80	120	180	ms	Figure 1-1 and $C_L = 50\text{ pF}$
$V_{DD}$ Detect to $\overline{RST}$ Active	$t_{RPD}$	—	130	—	$\mu\text{s}$	$V_{DD}$ ramped from $V_{TRIP(MAX)} + 250\text{ mV}$ down to $V_{TRIP(MIN)} - 250\text{ mV}$ , per Figure 1-1, $C_L = 50\text{ pF}$ (Note 1)
$\overline{RST}$ Rise Time After $\overline{RST}$ Active (MCP102 and MCP103 only)	$t_{RT}$	—	5	—	$\mu\text{s}$	For $\overline{RST}$ 10% to 90% of final value per Figure 1-1, $C_L = 50\text{ pF}$ (Note 1)

Note 1: These parameters are for design guidance only and are not 100% tested.

## TEMPERATURE CHARACTERISTICS

**Electrical Specifications:** Unless otherwise noted, all limits are specified for:  $V_{DD} = 1V$  to  $5.5V$ ,  $R_{PU} = 100\text{ k}\Omega$  (MCP121 only),  $T_A = -40^\circ\text{C}$  to  $+125^\circ\text{C}$ .

Parameters	Sym	Min	Typ	Max	Units	Conditions
<b>Temperature Ranges</b>						
Specified Temperature Range	$T_A$	-40	—	+85	$^\circ\text{C}$	MCP1XX-195
Specified Temperature Range	$T_A$	-40	—	+125	$^\circ\text{C}$	Except MCP1XX-195
Maximum Junction Temperature	$T_J$	—	—	+150	$^\circ\text{C}$	
Storage Temperature Range	$T_A$	-65	—	+150	$^\circ\text{C}$	
<b>Package Thermal Resistances</b>						
Thermal Resistance, 3L-SOT23	$\theta_{JA}$	—	336	—	$^\circ\text{C}/\text{W}$	
Thermal Resistance, 3L-SC-70	$\theta_{JA}$	—	340	—	$^\circ\text{C}/\text{W}$	
Thermal Resistance, 3L-TO-92	$\theta_{JA}$	—	131.9	—	$^\circ\text{C}/\text{W}$	

## 2.0 TYPICAL PERFORMANCE CURVES

**Note:** The graphs and tables provided following this note are a statistical summary based on a limited number of samples and are provided for informational purposes only. The performance characteristics listed herein are not tested or guaranteed. In some graphs or tables, the data presented may be outside the specified operating range (e.g., outside specified power supply range) and therefore outside the warranted range.

**Note:** Unless otherwise indicated, all limits are specified for:  $V_{DD} = 1V$  to  $5.5V$ ,  $R_{PU} = 100\text{ k}\Omega$  (MCP121 only); see Figure 4-1),  $T_A = -40^\circ\text{C}$  to  $+125^\circ\text{C}$ .



**FIGURE 2-1:**  $I_{DD}$  vs. Temperature (Reset Power-up Timer Inactive) (MCP102-195).



**FIGURE 2-4:**  $I_{DD}$  vs. Temperature (Reset Power-up Timer Active) (MCP102-195).



**FIGURE 2-2:**  $I_{DD}$  vs. Temperature (Reset Power-up Timer Inactive) (MCP131-315).



**FIGURE 2-5:**  $I_{DD}$  vs. Temperature (Reset Power-up Timer Active) (MCP131-315).



**FIGURE 2-3:**  $I_{DD}$  vs. Temperature (Reset Power-up Timer Inactive) (MCP121-450).



**FIGURE 2-6:**  $I_{DD}$  vs. Temperature (Reset Power-up Timer Active) (MCP121-450).

# MCP102/103/121/131

**Note:** Unless otherwise indicated, all limits are specified for:  $V_{DD} = 1V$  to  $5.5V$ ,  $R_{PU} = 100\text{ k}\Omega$  (MCP121 only; see Figure 4-1),  $T_A = -40^\circ\text{C}$  to  $+125^\circ\text{C}$ .



**FIGURE 2-7:**  $I_{DD}$  vs.  $V_{DD}$   
(Reset Power-up Timer Inactive) (MCP102-195).



**FIGURE 2-10:**  $I_{DD}$  vs.  $V_{DD}$   
(Reset Power-up Timer Active) (MCP102-195).



**FIGURE 2-8:**  $I_{DD}$  vs.  $V_{DD}$   
(Reset Power-up Timer Inactive) (MCP131-315).



**FIGURE 2-11:**  $I_{DD}$  vs.  $V_{DD}$   
(Reset Power-up Timer Active) (MCP131-315).



**FIGURE 2-9:**  $I_{DD}$  vs.  $V_{DD}$   
(Reset Power-up Timer Inactive) (MCP121-450).



**FIGURE 2-12:**  $I_{DD}$  vs.  $V_{DD}$   
(Reset Power-up Timer Active) (MCP121-450).

# MCP102/103/121/131

**Note:** Unless otherwise indicated, all limits are specified for:  $V_{DD} = 1V$  to  $5.5V$ ,  $R_{PU} = 100\text{ k}\Omega$  (MCP121; see Figure 4-1),  $T_A = -40^\circ\text{C}$  to  $+125^\circ\text{C}$ .



**FIGURE 2-13:**  $V_{TRIP}$  vs. Temperature vs. Hysteresis (MCP102-195).



**FIGURE 2-16:**  $V_{OL}$  vs.  $I_{OL}$  (MCP102-195 @  $V_{DD} = 1.7V$ ).

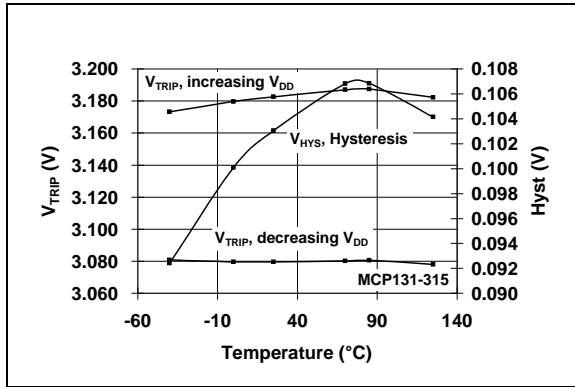

**FIGURE 2-14:**  $V_{TRIP}$  vs. Temperature vs. Hysteresis (MCP131-315).

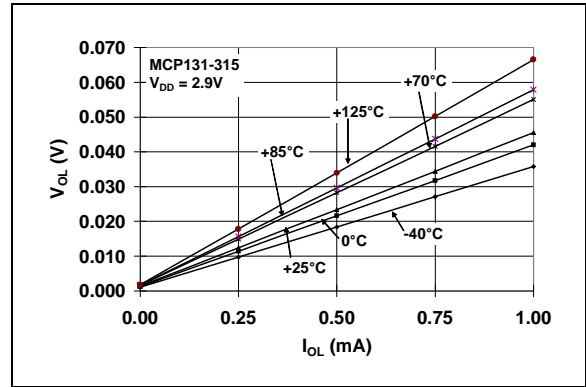

**FIGURE 2-17:**  $V_{OL}$  vs.  $I_{OL}$  (MCP131-315 @  $V_{DD} = 2.9V$ ).



**FIGURE 2-15:**  $V_{TRIP}$  vs. Temperature vs. Hysteresis (MCP121-450).



**FIGURE 2-18:**  $V_{OL}$  vs.  $I_{OL}$  (MCP121-450 @  $V_{DD} = 4.1V$ ).

# MCP102/103/121/131

**Note:** Unless otherwise indicated, all limits are specified for:  $V_{DD} = 1V$  to  $5.5V$ ,  $R_{PU} = 100\text{ k}\Omega$  (MCP121 only; see Figure 4-1),  $T_A = -40^\circ\text{C}$  to  $+125^\circ\text{C}$ .



**FIGURE 2-19:**  $V_{OL}$  vs. Temperature (MCP102-195 @  $V_{DD} = 1.7V$ ).



**FIGURE 2-22:**  $V_{OH}$  vs.  $I_{OL}$  (MCP102-195 @  $V_{DD} = 2.1V$ ).



**FIGURE 2-20:**  $V_{OL}$  vs. Temperature (MCP131-315 @  $V_{DD} = 2.9V$ ).



**FIGURE 2-21:**  $V_{OL}$  vs. Temperature (MCP121-450 @  $V_{DD} = 4.1V$ ).



# MCP102/103/121/131

**Note:** Unless otherwise indicated, all limits are specified for:  $V_{DD} = 1V$  to  $5.5V$ ,  $R_{PU} = 100\text{ k}\Omega$  (MCP121 only; see Figure 4-1),  $T_A = -40^\circ\text{C}$  to  $+125^\circ\text{C}$ .



**FIGURE 2-23:**  $t_{RPD}$  vs. Temperature (MCP102-195).



**FIGURE 2-26:**  $t_{RPU}$  vs. Temperature (MCP102-195).

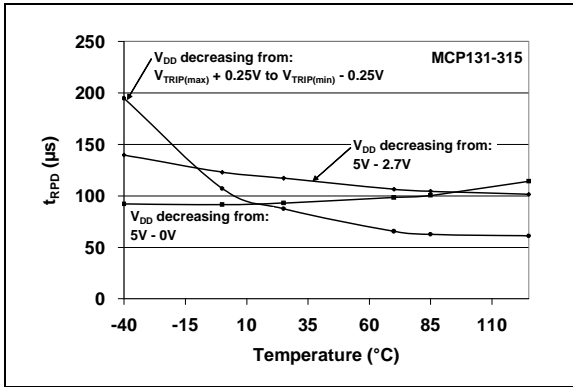

**FIGURE 2-24:**  $t_{RPD}$  vs. Temperature (MCP131-315).

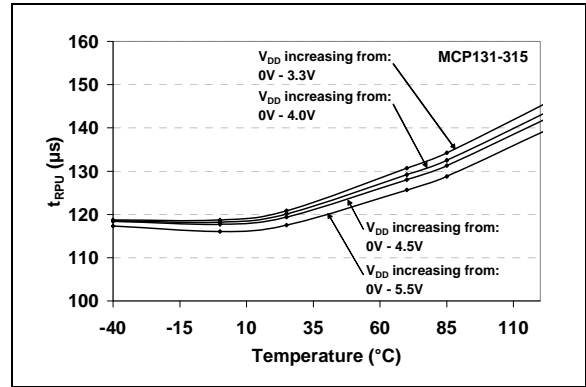

**FIGURE 2-27:**  $t_{RPU}$  vs. Temperature (MCP131-315).



**FIGURE 2-25:**  $t_{RPD}$  vs. Temperature (MCP121-450).



**FIGURE 2-28:**  $t_{RPU}$  vs. Temperature (MCP121-450).

# MCP102/103/121/131

**Note:** Unless otherwise indicated, all limits are specified for:  $V_{DD} = 1V$  to  $5.5V$ ,  $R_{PU} = 100\text{ k}\Omega$  (MCP121 only; see Figure 4-1),  $T_A = -40^\circ\text{C}$  to  $+125^\circ\text{C}$ .



**FIGURE 2-29:**  $t_{RT}$  vs. Temperature (MCP102-195).

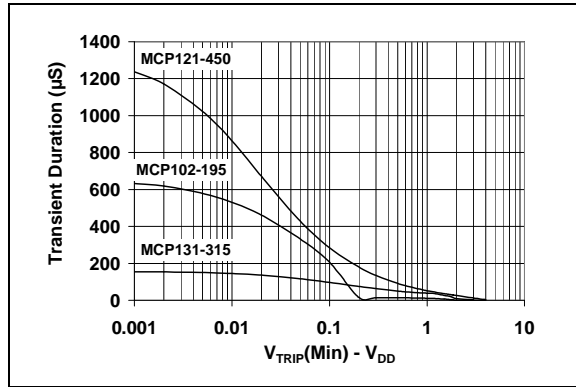

**FIGURE 2-32:** Transient Duration vs.  $V_{TRIP}(\text{min}) - V_{DD}$ .

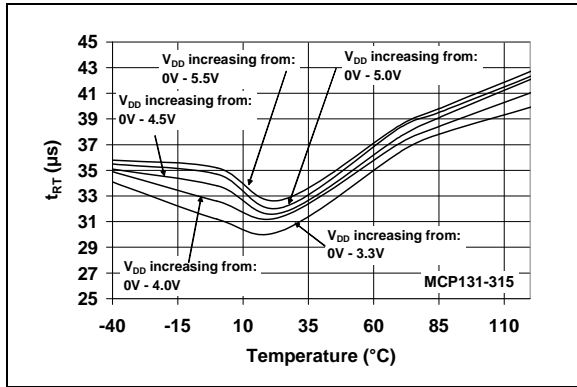

**FIGURE 2-30:**  $t_{RT}$  vs. Temperature (MCP131-315).

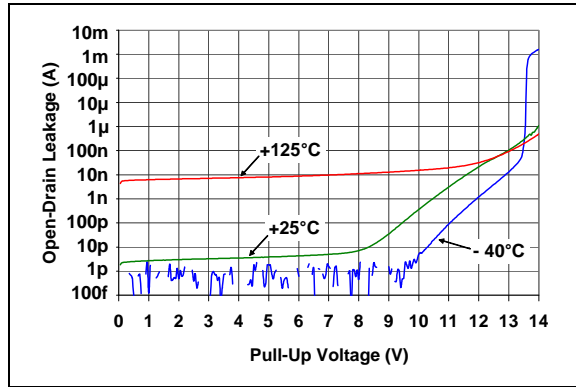

**FIGURE 2-33:** Open-Drain Leakage Current vs. Voltage Applied to  $V_{OUT}$  Pin (MCP121-195).



**FIGURE 2-31:**  $t_{RT}$  vs. Temperature (MCP121-450).

## 3.0 PIN DESCRIPTION

The descriptions of the pins are listed in Table 3-1.

**TABLE 3-1: PIN FUNCTION TABLE**

Pin No.		Symbol	Function
MCP102 MCP121 MCP131	MCP103		
1	1	$\overline{\text{RST}}$	Output State <b>V<sub>DD</sub> Falling:</b> $H = V_{DD} > V_{TRIP}$ $L = V_{DD} < V_{TRIP}$  <b>V<sub>DD</sub> Rising:</b> $H = V_{DD} > V_{TRIP} + V_{HYS}$ $L = V_{DD} < V_{TRIP} + V_{HYS}$
2	3	V <sub>DD</sub>	Positive power supply
3	2	V <sub>SS</sub>	Ground reference

# MCP102/103/121/131

## 4.0 APPLICATION INFORMATION

For many of today's microcontroller applications, care must be taken to prevent low-power conditions that can cause many different system problems. The most common causes are brown-out conditions, where the system supply drops below the operating level momentarily. The second most common cause is when a slowly decaying power supply causes the microcontroller to begin executing instructions without sufficient voltage to sustain volatile memory (RAM), thus producing indeterminate results. Figure 4-1 shows a typical application circuit.

The MCP102/103/121/131 are voltage supervisor devices designed to keep a microcontroller in reset until the system voltage has reached and stabilized at the proper level for reliable system operation. These devices also operate as protection from brown-out conditions.



**FIGURE 4-1:** Typical Application Circuit.

## 4.1 $\overline{RST}$ Operation

The  $\overline{RST}$  output pin operation determines how the device can be used and indicates when the system should be forced into reset. To accomplish this, an internal voltage reference is used to set the voltage trip point ( $V_{TRIP}$ ). Additionally, there is a hysteresis on this trip point.

When the falling edge of  $V_{DD}$  crosses this voltage threshold, the reset power-down timer ( $T_{RPD}$ ) starts. When this delay timer times out, the  $\overline{RST}$  pin is forced low.

When the rising-edge of  $V_{DD}$  crosses this voltage threshold, the reset power-up timer ( $T_{RPU}$ ) starts. When this delay timer times out, the  $\overline{RST}$  pin is forced high,  $T_{RPU}$  is active and there is additional system current.

The actual voltage trip point ( $V_{TRIPAC}$ ) will be between the minimum trip point ( $V_{TRIPMIN}$ ) and the maximum trip point ( $V_{TRIPMAX}$ ). The hysteresis on this trip point and the delay timer ( $T_{RPU}$ ) are to remove any "jitter" that would occur on the  $\overline{RST}$  pin when the device  $V_{DD}$  is at the trip point.

Figure 4-2 shows the waveform of the  $\overline{RST}$  pin as determined by the  $V_{DD}$  voltage, while Table 4-1 shows the state of the  $\overline{RST}$  pin. The  $V_{TRIP}$  specification is for falling  $V_{DD}$  voltages. When the  $V_{DD}$  voltage is rising, the  $\overline{RST}$  will not be driven high until  $V_{DD}$  is at  $V_{TRIP} + V_{HYS}$ . Once  $V_{DD}$  has crossed the voltage trip point, there is also a minimal delay time ( $T_{RPD}$ ) before the  $\overline{RST}$  pin is driven low.

**TABLE 4-1:  $\overline{RST}$  PIN STATES**

Device	State of $\overline{RST}$ Pin when:		Output Driver
	$V_{DD} < V_{TRIP}$	$V_{DD} > V_{TRIP} + V_{HYS}$	
MCP102	L	H	Push-pull
MCP103	L	H	Push-pull
MCP121	L	H (1)	Open-drain (1)
MCP131	L	H (2)	Open-drain (2)

**Note 1:** Requires External Pull-up resistor

**2:** Has Internal Pull-up resistor



**FIGURE 4-2:**  $\overline{RST}$  Operation as Determined by the  $V_{TRIP}$  and  $V_{HYS}$ .

## 4.2 Negative Going $V_{DD}$ Transients

The minimum pulse width (time) required to cause a reset may be an important criteria in the implementation of a Power-on Reset (POR) circuit. This time is referred to as transient duration, defined as the amount of time needed for these supervisory devices to respond to a drop in  $V_{DD}$ . The transient duration time is dependant on the magnitude of  $V_{TRIP} - V_{DD}$ . Generally speaking, the transient duration decreases with increases in  $V_{TRIP} - V_{DD}$ .

Figure 4-3 shows a typical transient duration vs. reset comparator overdrive, for which the MCP102/103/121/131 will not generate a reset pulse. It shows that the farther below the trip point the transient pulse goes, the duration of the pulse required to cause a reset gets shorter. Figure 2-32 shows the transient response characteristics for the MCP102/103/121/131.

A 0.1  $\mu\text{F}$  bypass capacitor, mounted as close as possible to the  $V_{DD}$  pin, provides additional transient immunity (refer to Figure 4-1).



**FIGURE 4-3:** Example of Typical Transient Duration Waveform.

## 4.3 Reset Power-up Timer ( $t_{RPU}$ )

Figure 4-4 illustrates the device current states. While the system is powering down, the device has a low current. This current is dependent on the device  $V_{DD}$  and trip point. When the device  $V_{DD}$  rises through the voltage trip point ( $V_{TRIP}$ ), an internal timer starts. This timer consumes additional current until the  $\overline{\text{RST}}$  pin is driven (or released) high. This time is known as the Reset Power-up Time ( $t_{RPU}$ ). Figure 4-4 shows when  $t_{RPU}$  is active (device consuming additional current).

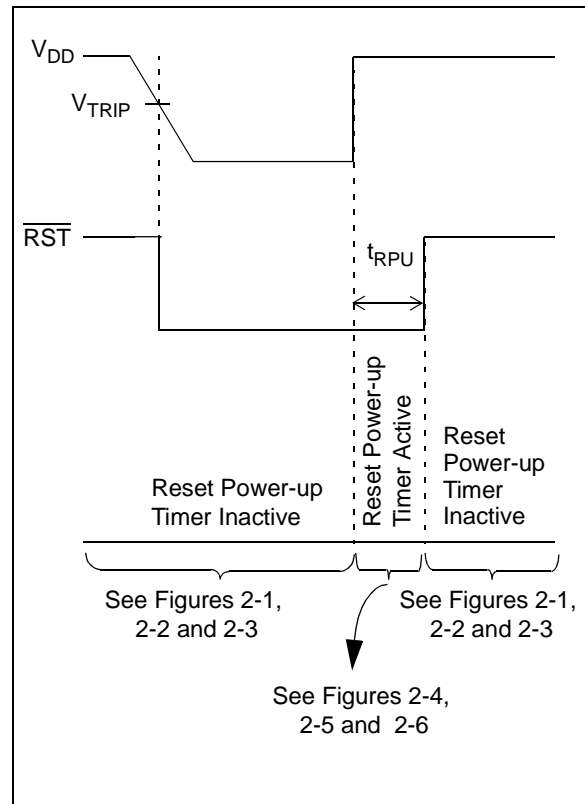

**FIGURE 4-4:** Reset Power-up Timer Waveform.

### 4.3.1 EFFECT OF TEMPERATURE ON RESET POWER-UP TIMER ( $T_{RPU}$ )

The Reset Power-up timer time-out period ( $t_{RPU}$ ) determines how long the device remains in the reset condition. This is affected by both  $V_{DD}$  and temperature. Typical responses for different  $V_{DD}$  values and temperatures are shown in Figures 2-26, 2-27 and 2-28.

# MCP102/103/121/131

## 4.4 Using in PIC<sup>®</sup> Microcontroller, ICSP<sup>™</sup> Applications (MCP121 only)

Figure 4-5 shows the typical application circuit for using the MCP121 for voltage supervisory function when the PIC microcontroller will be programmed via the ICSP feature. Additional information is available in TB087, "Using Voltage Supervisors with PIC<sup>®</sup> Microcontroller Systems which Implement In-Circuit Serial Programming<sup>™</sup>", DS91087.

**Note:** It is recommended that the current into the RST pin be current limited by a 1 k $\Omega$  resistor.



**FIGURE 4-5:** Typical Application Circuit for PIC<sup>®</sup> Microcontroller with the ICSP<sup>™</sup> feature.

## 5.0 PACKAGING INFORMATION

### 5.1 Package Marking Information

3-Lead TO-92



Example:



3-Pin SOT-23



Example:

Part Number	MCP1xx =			
	MCP102	MCP103	MCP121	MCP131
MCP1xxT-195I/TT	JGNN	TGNN	LGNN	KGNN
MCP1xxT-240ETT	JHNN	THNN	LHNN	KHNN
MCP1xxT-270E/TT	JJNN	TJNN	LJNN	KJNN
MCP1xxT-300E/TT	JKNN	TKNN	LKNN	KKNN
MCP1xxT-315E/TT	JLNN	TLNN	LLNN	KLNN
MCP1xxT-450E/TT	JMNN	TMNN	LMNN	KMNN
MCP1xxT-475E/TT	JPNN	TPNN	LPNN	KPNN

<b>Legend:</b>	XX...X	Customer-specific information
	Y	Year code (last digit of calendar year)
	WW	Week code (week of January 1 is week '01')
	NNN	Alphanumeric traceability code
	(e3)	Pb-free JEDEC designator for Matte Tin (Sn)
	*	This package is Pb-free. The Pb-free JEDEC designator (e3) can be found on the outer packaging for this package.
<b>Note:</b>	In the event the full Microchip part number cannot be marked on one line, it will be carried over to the next line, thus limiting the number of available characters for customer-specific information.	

# MCP102/103/121/131

## Package Marking Information (Continued)



**Example:**

Part Number	MCP1xx =			
	MCP102	MCP103	MCP121	MCP131
MCP1xxT-195I/LB	BGN	FGN	DGN	CGN
MCP1xxT-240E/LB	BHN	FHN	DHN	CHN
MCP1xxT-270E/LB	BJN	FJN	DJN	CJN
MCP1xxT-300E/LB	BKN	FKN	DKN	CKN
MCP1xxT-315E/LB	BLN	FLN	DLN	CLN
MCP1xxT-450E/LB	BMN	FMN	DMN	CMN
MCP1xxT-475E/LB	BPN	FPN	DPN	CPN

**OR**



**Example:**

Part Number	MCP1xx =			
	MCP102	MCP103	MCP121	MCP131
MCP1xxT-195I/LB	BGNN	FGNN	DGNN	CGNN
MCP1xxT-240E/LB	BHNN	FHNN	DHNN	CHNN
MCP1xxT-270E/LB	BJNN	FJNN	DJNN	CJNN
MCP1xxT-300E/LB	BKNN	FKNN	DKNN	CKNN
MCP1xxT-315E/LB	BLNN	FLNN	DLNN	CLNN
MCP1xxT-450E/LB	BMNN	FMNN	DMNN	CMNN
MCP1xxT-475E/LB	BPNN	FPNN	DPNN	CPNN



## 3-Lead Plastic Small Outline Transistor (TT) (SOT-23)

**Note:** For the most current package drawings, please see the Microchip Packaging Specification located at <http://www.microchip.com/packaging>



Dimension Limits	Units	INCHES*			MILLIMETERS		
		MIN	NOM	MAX	MIN	NOM	MAX
Number of Pins	n		3			3	
Pitch	p		.038			0.96	
Outside lead pitch (basic)	p1		.076			1.92	
Overall Height	A	.035	.040	.044	0.89	1.01	1.12
Molded Package Thickness	A2	.035	.037	.040	0.88	0.95	1.02
Standoff §	A1	.000	.002	.004	0.01	0.06	0.10
Overall Width	E	.083	.093	.104	2.10	2.37	2.64
Molded Package Width	E1	.047	.051	.055	1.20	1.30	1.40
Overall Length	D	.110	.115	.120	2.80	2.92	3.04
Foot Length	L	.014	.018	.022	0.35	0.45	0.55
Foot Angle	φ	0	5	10	0	5	10
Lead Thickness	c	.004	.006	.007	0.09	0.14	0.18
Lead Width	B	.015	.017	.020	0.37	0.44	0.51
Mold Draft Angle Top	α	0	5	10	0	5	10
Mold Draft Angle Bottom	β	0	5	10	0	5	10

\* Controlling Parameter

§ Significant Characteristic

Notes:

Dimensions D and E1 do not include mold flash or protrusions. Mold flash or protrusions shall not exceed .010" (0.254mm) per side.

JEDEC Equivalent: TO-236

Drawing No. C04-104

# MCP102/103/121/131

## 3-Lead Plastic Small Outline Transistor (LB) (SC-70)

**Note:** For the most current package drawings, please see the Microchip Packaging Specification located at <http://www.microchip.com/packaging>



Dimension Limits	Units	INCHES		MILLIMETERS*	
		MIN	MAX	MIN	MAX
Number of Pins		3		3	
Pitch	P	.026 BSC.		0.65 BSC.	
Outside lead pitch (basic)	p1	.051 BSC.		1.30 BSC.	
Overall Height	A	.031	.043	0.80	1.10
Molded Package Thickness	A2	.031	.039	0.80	1.00
Standoff	A1	.000	.0004	0.00	.010
Overall Width	E	.071	.094	1.80	2.40
Molded Package Width	E1	.045	.053	1.15	1.35
Overall Length	D	.071	.089	1.80	2.25
Foot Length	L	.004	.016	0.10	0.41
Lead Thickness	c	.003	.010	0.08	0.25
Lead Width	B	.006	.016	0.15	0.40
Mold Draft Angle Top	a	8°	12°	8°	12°
Mold Draft Angle Bottom	b	8°	12°	8°	12°

\*Controlling Parameter

Notes:

Dimensions D and E1 do not include mold flash or protrusions. Mold flash or protrusions shall not exceed .005" (0.127mm) per side.

JEITA (EIAJ) Equivalent: SC70

Drawing No. C04-104

## 3-Lead Plastic Transistor Outline (TO) (TO-92)

**Note:** For the most current package drawings, please see the Microchip Packaging Specification located at <http://www.microchip.com/packaging>



Dimension Limits	Units	INCHES*			MILLIMETERS		
		MIN	NOM	MAX	MIN	NOM	MAX
Number of Pins	n		3			3	
Pitch	p		.050			1.27	
Bottom to Package Flat	A	.130	.143	.155	3.30	3.62	3.94
Overall Width	E1	.175	.186	.195	4.45	4.71	4.95
Overall Length	D	.170	.183	.195	4.32	4.64	4.95
Molded Package Radius	R	.085	.090	.095	2.16	2.29	2.41
Tip to Seating Plane	L	.500	.555	.610	12.70	14.10	15.49
Lead Thickness	c	.014	.017	.020	0.36	0.43	0.51
Lead Width	B	.016	.019	.022	0.41	0.48	0.56
Mold Draft Angle Top	$\alpha$	4	5	6	4	5	6
Mold Draft Angle Bottom	$\beta$	2	3	4	2	3	4

\*Controlling Parameter

Notes:

Dimensions D and E1 do not include mold flash or protrusions. Mold flash or protrusions shall not exceed .010" (0.254mm) per side.

JEDEC Equivalent: TO-92

Drawing No. C04-101

# MCP102/103/121/131

## 5.2 Product Tape and Reel Specifications

**FIGURE 5-1: EMBOSSED CARRIER DIMENSIONS (8, 12, 16 AND 24 MM TAPE ONLY)**



**TABLE 1: CARRIER TAPE/CAVITY DIMENSIONS**

Case Outline	Package Type		Carrier Dimensions		Cavity Dimensions			Output Quantity Units	Reel Diameter in mm
			W mm	P mm	A0 mm	B0 mm	K0 mm		
TT	SOT-23	3L	8	4	3.15	2.77	1.22	3000	180
LB	SC-70	3L	8	4	2.4	2.4	1.19	3000	180

**FIGURE 5-2: 3-LEAD SOT-23/SC70 DEVICE TAPE AND REEL SPECIFICATIONS**



FIGURE 5-3: TO-92 DEVICE TAPE AND REEL SPECIFICATIONS



# MCP102/103/121/131

---

NOTES:

## APPENDIX A: REVISION HISTORY

### Revision C (January 2013)

- Added a note to each package outline drawing.

### Revision B (March 2005)

The following is the list of modifications:

1. Added **Section 4.4 “Using in PIC® Microcontroller, ICSP™ Applications (MCP121 only)”** on using the MCP121 in PIC microcontroller ICSP applications.
2. Added  $V_{ODH}$  specifications in **Section 1.0 “Electrical Characteristics”** (for ICSP applications).
3. Added Figure 2-33.
4. Updated SC-70 package markings and added Pb-free marking information to **Section 5.0 “Packaging information”**.
5. Added **Appendix A: “Revision History”**.

### Revision A (August 2004)

- Original Release of this Document.

# MCP102/103/121/131

---

NOTES:



## PRODUCT IDENTIFICATION SYSTEM

To order or obtain information, e.g., on pricing or delivery, refer to the factory or the listed sales office.

<u>PART NO.</u>	- X	XXX	X	/	XX
Device	Tape/Reel Option	Monitoring Options	Temperature Range		Package
<p>Device:</p> <p>MCP102: MicroPower Voltage Supervisor, push-pull MCP102T: MicroPower Voltage Supervisor, push-pull (Tape and Reel)</p> <p>MCP103: MicroPower Voltage Supervisor, push-pull MCP103T: MicroPower Voltage Supervisor, push-pull (Tape and Reel)</p> <p>MCP121: MicroPower Voltage Supervisor, open-drain MCP121T: MicroPower Voltage Supervisor, open-drain (Tape and Reel)</p> <p>MCP131: MicroPower Voltage Supervisor, open-drain MCP131T: MicroPower Voltage Supervisor, open-drain (Tape and Reel)</p> <p>Monitoring Options:</p> <p>195 = 1.90V 240 = 2.32V 270 = 2.63V 300 = 2.93V 315 = 3.08V 450 = 4.38V 475 = 4.63V</p> <p>Temperature Range:</p> <p>I = -40°C to +85°C (MCP11X-195 only) E = -40°C to +125°C (Except MCP11X-195 only)</p> <p>Package:</p> <p>TT = SOT-23B, 3-lead LB = SC-70, 3-lead TO = TO-92, 3-lead</p>					
<b>Examples:</b>					
a) MCP102T-195I/TT: Tape and Reel, 1.95V MicroPower Voltage Supervisor, push-pull, -40°C to +85°C, SOT-23B-3 package.					
b) MCP102-300E/TO: 3.00V MicroPower Voltage Supervisor, push-pull, -40°C to +125°C, TO-92-3 package.					
a) MCP103T-270E/TT: Tape and Reel, 2.70V MicroPower Voltage Supervisor, push-pull, -40°C to +125°C, SOT-23B-3 package.					
b) MCP103T-475E/LB: Tape and Reel, 4.75V MicroPower Voltage Supervisor, push-pull, -40°C to +125°C, SC-70-3 package.					
a) MCP121T-315I/LB: Tape and Reel, 3.15V MicroPower Voltage Supervisor, open-drain, -40°C to +125°C, SC-70-3 package.					
b) MCP121-300E/TO: 3.00V MicroPower Voltage Supervisor, open-drain, -40°C to +125°C, TO-92-3 package.					
a) MCP131T-195I/TT: Tape and Reel, 1.95V MicroPower Voltage Supervisor, open-drain, -40°C to +85°C, SOT-23B-3 package.					
b) MCP131-300E/TO: 3.00V MicroPower Voltage Supervisor, open-drain, -40°C to +125°C, TO-92-3 package.					

# MCP102/103/121/131

---

NOTES:

---

---

**Note the following details of the code protection feature on Microchip devices:**

- Microchip products meet the specification contained in their particular Microchip Data Sheet.
- Microchip believes that its family of products is one of the most secure families of its kind on the market today, when used in the intended manner and under normal conditions.
- There are dishonest and possibly illegal methods used to breach the code protection feature. All of these methods, to our knowledge, require using the Microchip products in a manner outside the operating specifications contained in Microchip's Data Sheets. Most likely, the person doing so is engaged in theft of intellectual property.
- Microchip is willing to work with the customer who is concerned about the integrity of their code.
- Neither Microchip nor any other semiconductor manufacturer can guarantee the security of their code. Code protection does not mean that we are guaranteeing the product as “unbreakable.”

Code protection is constantly evolving. We at Microchip are committed to continuously improving the code protection features of our products. Attempts to break Microchip's code protection feature may be a violation of the Digital Millennium Copyright Act. If such acts allow unauthorized access to your software or other copyrighted work, you may have a right to sue for relief under that Act.

---

Information contained in this publication regarding device applications and the like is provided only for your convenience and may be superseded by updates. It is your responsibility to ensure that your application meets with your specifications. MICROCHIP MAKES NO REPRESENTATIONS OR WARRANTIES OF ANY KIND WHETHER EXPRESS OR IMPLIED, WRITTEN OR ORAL, STATUTORY OR OTHERWISE, RELATED TO THE INFORMATION, INCLUDING BUT NOT LIMITED TO ITS CONDITION, QUALITY, PERFORMANCE, MERCHANTABILITY OR FITNESS FOR PURPOSE. Microchip disclaims all liability arising from this information and its use. Use of Microchip devices in life support and/or safety applications is entirely at the buyer's risk, and the buyer agrees to defend, indemnify and hold harmless Microchip from any and all damages, claims, suits, or expenses resulting from such use. No licenses are conveyed, implicitly or otherwise, under any Microchip intellectual property rights.

#### **Trademarks**

The Microchip name and logo, the Microchip logo, dsPIC, FlashFlex, KEELOQ, KEELOQ logo, MPLAB, PIC, PICmicro, PICSTART, PIC<sup>32</sup> logo, rPIC, SST, SST Logo, SuperFlash and UNI/O are registered trademarks of Microchip Technology Incorporated in the U.S.A. and other countries.

FilterLab, Hampshire, HI-TECH C, Linear Active Thermistor, MTP, SEEVAL and The Embedded Control Solutions Company are registered trademarks of Microchip Technology Incorporated in the U.S.A.

Silicon Storage Technology is a registered trademark of Microchip Technology Inc. in other countries.

Analog-for-the-Digital Age, Application Maestro, BodyCom, chipKIT, chipKIT logo, CodeGuard, dsPICDEM, dsPICDEM.net, dsPICworks, dsSPEAK, ECAN, ECONOMONITOR, FanSense, HI-TIDE, In-Circuit Serial Programming, ICSP, Mindi, MiWi, MPASM, MPF, MPLAB Certified logo, MPLIB, MPLINK, mTouch, Omniclient Code Generation, PICC, PICC-18, PICDEM, PICDEM.net, PICkit, PICtail, REAL ICE, rLAB, Select Mode, SQI, Serial Quad I/O, Total Endurance, TSHARC, UniWinDriver, WiperLock, ZENA and Z-Scale are trademarks of Microchip Technology Incorporated in the U.S.A. and other countries.

SQTP is a service mark of Microchip Technology Incorporated in the U.S.A.

GestIC and ULPP are registered trademarks of Microchip Technology Germany II GmbH & Co. & KG, a subsidiary of Microchip Technology Inc., in other countries.

All other trademarks mentioned herein are property of their respective companies.

© 2004-2012, Microchip Technology Incorporated, Printed in the U.S.A., All Rights Reserved.

 Printed on recycled paper.

ISBN: 9781620769157

**QUALITY MANAGEMENT SYSTEM**  
**CERTIFIED BY DNV**  
**== ISO/TS 16949 ==**

*Microchip received ISO/TS-16949:2009 certification for its worldwide headquarters, design and wafer fabrication facilities in Chandler and Tempe, Arizona; Gresham, Oregon and design centers in California and India. The Company's quality system processes and procedures are for its PIC<sup>®</sup> MCUs and dsPIC<sup>®</sup> DSCs, KEELOQ<sup>®</sup> code hopping devices, Serial EEPROMs, microperipherals, nonvolatile memory and analog products. In addition, Microchip's quality system for the design and manufacture of development systems is ISO 9001:2000 certified.*



# MICROCHIP

## Worldwide Sales and Service

### AMERICAS

**Corporate Office**  
2355 West Chandler Blvd.  
Chandler, AZ 85224-6199  
Tel: 480-792-7200  
Fax: 480-792-7277  
Technical Support:  
<http://www.microchip.com/support>  
Web Address:  
[www.microchip.com](http://www.microchip.com)

**Atlanta**  
Duluth, GA  
Tel: 678-957-9614  
Fax: 678-957-1455

**Boston**  
Westborough, MA  
Tel: 774-760-0087  
Fax: 774-760-0088

**Chicago**  
Itasca, IL  
Tel: 630-285-0071  
Fax: 630-285-0075

**Cleveland**  
Independence, OH  
Tel: 216-447-0464  
Fax: 216-447-0643

**Dallas**  
Addison, TX  
Tel: 972-818-7423  
Fax: 972-818-2924

**Detroit**  
Farmington Hills, MI  
Tel: 248-538-2250  
Fax: 248-538-2260

**Indianapolis**  
Noblesville, IN  
Tel: 317-773-8323  
Fax: 317-773-5453

**Los Angeles**  
Mission Viejo, CA  
Tel: 949-462-9523  
Fax: 949-462-9608

**Santa Clara**  
Santa Clara, CA  
Tel: 408-961-6444  
Fax: 408-961-6445

**Toronto**  
Mississauga, Ontario,  
Canada  
Tel: 905-673-0699  
Fax: 905-673-6509

### ASIA/PACIFIC

**Asia Pacific Office**  
Suites 3707-14, 37th Floor  
Tower 6, The Gateway  
Harbour City, Kowloon  
Hong Kong  
Tel: 852-2401-1200  
Fax: 852-2401-3431

**Australia - Sydney**  
Tel: 61-2-9868-6733  
Fax: 61-2-9868-6755

**China - Beijing**  
Tel: 86-10-8569-7000  
Fax: 86-10-8528-2104

**China - Chengdu**  
Tel: 86-28-8665-5511  
Fax: 86-28-8665-7889

**China - Chongqing**  
Tel: 86-23-8980-9588  
Fax: 86-23-8980-9500

**China - Hangzhou**  
Tel: 86-571-2819-3187  
Fax: 86-571-2819-3189

**China - Hong Kong SAR**  
Tel: 852-2943-5100  
Fax: 852-2401-3431

**China - Nanjing**  
Tel: 86-25-8473-2460  
Fax: 86-25-8473-2470

**China - Qingdao**  
Tel: 86-532-8502-7355  
Fax: 86-532-8502-7205

**China - Shanghai**  
Tel: 86-21-5407-5533  
Fax: 86-21-5407-5066

**China - Shenyang**  
Tel: 86-24-2334-2829  
Fax: 86-24-2334-2393

**China - Shenzhen**  
Tel: 86-755-8864-2200  
Fax: 86-755-8203-1760

**China - Wuhan**  
Tel: 86-27-5980-5300  
Fax: 86-27-5980-5118

**China - Xian**  
Tel: 86-29-8833-7252  
Fax: 86-29-8833-7256

**China - Xiamen**  
Tel: 86-592-2388138  
Fax: 86-592-2388130

**China - Zhuhai**  
Tel: 86-756-3210040  
Fax: 86-756-3210049

### ASIA/PACIFIC

**India - Bangalore**  
Tel: 91-80-3090-4444  
Fax: 91-80-3090-4123

**India - New Delhi**  
Tel: 91-11-4160-8631  
Fax: 91-11-4160-8632

**India - Pune**  
Tel: 91-20-2566-1512  
Fax: 91-20-2566-1513

**Japan - Osaka**  
Tel: 81-6-6152-7160  
Fax: 81-6-6152-9310

**Japan - Tokyo**  
Tel: 81-3-6880-3770  
Fax: 81-3-6880-3771

**Korea - Daegu**  
Tel: 82-53-744-4301  
Fax: 82-53-744-4302

**Korea - Seoul**  
Tel: 82-2-554-7200  
Fax: 82-2-558-5932 or  
82-2-558-5934

**Malaysia - Kuala Lumpur**  
Tel: 60-3-6201-9857  
Fax: 60-3-6201-9859

**Malaysia - Penang**  
Tel: 60-4-227-8870  
Fax: 60-4-227-4068

**Philippines - Manila**  
Tel: 63-2-634-9065  
Fax: 63-2-634-9069

**Singapore**  
Tel: 65-6334-8870  
Fax: 65-6334-8850

**Taiwan - Hsin Chu**  
Tel: 886-3-5778-366  
Fax: 886-3-5770-955

**Taiwan - Kaohsiung**  
Tel: 886-7-213-7828  
Fax: 886-7-330-9305

**Taiwan - Taipei**  
Tel: 886-2-2508-8600  
Fax: 886-2-2508-0102

**Thailand - Bangkok**  
Tel: 66-2-694-1351  
Fax: 66-2-694-1350

### EUROPE

**Austria - Wels**  
Tel: 43-7242-2244-39  
Fax: 43-7242-2244-393

**Denmark - Copenhagen**  
Tel: 45-4450-2828  
Fax: 45-4485-2829

**France - Paris**  
Tel: 33-1-69-53-63-20  
Fax: 33-1-69-30-90-79

**Germany - Munich**  
Tel: 49-89-627-144-0  
Fax: 49-89-627-144-44

**Italy - Milan**  
Tel: 39-0331-742611  
Fax: 39-0331-466781

**Netherlands - Drunen**  
Tel: 31-416-690399  
Fax: 31-416-690340

**Spain - Madrid**  
Tel: 34-91-708-08-90  
Fax: 34-91-708-08-91

**UK - Wokingham**  
Tel: 44-118-921-5869  
Fax: 44-118-921-5820

11/29/12

Компания «Океан Электроники» предлагает заключение долгосрочных отношений при поставках импортных электронных компонентов на взаимовыгодных условиях!

Наши преимущества:

- Поставка оригинальных импортных электронных компонентов напрямую с производств Америки, Европы и Азии, а так же с крупнейших складов мира;
- Широкая линейка поставок активных и пассивных импортных электронных компонентов (более 30 млн. наименований);
- Поставка сложных, дефицитных, либо снятых с производства позиций;
- Оперативные сроки поставки под заказ (от 5 рабочих дней);
- Экспресс доставка в любую точку России;
- Помощь Конструкторского Отдела и консультации квалифицированных инженеров;
- Техническая поддержка проекта, помощь в подборе аналогов, поставка прототипов;
- Поставка электронных компонентов под контролем ВП;
- Система менеджмента качества сертифицирована по Международному стандарту ISO 9001;
- При необходимости вся продукция военного и аэрокосмического назначения проходит испытания и сертификацию в лаборатории (по согласованию с заказчиком);
- Поставка специализированных компонентов военного и аэрокосмического уровня качества (Xilinx, Altera, Analog Devices, Intersil, Interpoint, Microsemi, Actel, Aeroflex, Peregrine, VPT, Syfer, Eurofarad, Texas Instruments, MS Kennedy, Miteq, Cobham, E2V, MA-COM, Hittite, Mini-Circuits, General Dynamics и др.);

Компания «Океан Электроники» является официальным дистрибьютором и эксклюзивным представителем в России одного из крупнейших производителей разъемов военного и аэрокосмического назначения «JONHON», а так же официальным дистрибьютором и эксклюзивным представителем в России производителя высокотехнологичных и надежных решений для передачи СВЧ сигналов «FORSTAR».



## JONHON

«JONHON» (основан в 1970 г.)

Разъемы специального, военного и аэрокосмического назначения:

(Применяются в военной, авиационной, аэрокосмической, морской, железнодорожной, горно- и нефтедобывающей отраслях промышленности)

«FORSTAR» (основан в 1998 г.)

ВЧ соединители, коаксиальные кабели,  
кабельные сборки и микроволновые компоненты:

(Применяются в телекоммуникациях гражданского и специального назначения, в средствах связи, РЛС, а так же военной, авиационной и аэрокосмической отраслях промышленности).



Телефон: 8 (812) 309-75-97 (многоканальный)

Факс: 8 (812) 320-03-32

Электронная почта: [ocean@oceanchips.ru](mailto:ocean@oceanchips.ru)

Web: <http://oceanchips.ru/>

Адрес: 198099, г. Санкт-Петербург, ул. Калинина, д. 2, корп. 4, лит. А