

# XC9110/XC9111 Series

ETR0406-008

## PFM Controlled Step-Up DC/DC Converter / Controller ICs

### ■ GENERAL DESCRIPTION

The XC9110/9111 series is a group of PFM controlled step-up DC/DC converter/controller ICs designed to generate low supply voltage by the combination of PFM control and CMOS structure. The series is ideal for applications where a longer battery life is needed such as in portable communication equipment. With a built-in  $2.5\Omega$  N-channel driver transistor, the XC9110A/C/E and XC9111A/C/E types provide a step-up operation by using only a coil, a capacitor, and a diode connected externally.

The XC9110/9111B, D and F versions can be used with an external transistor for applications requiring larger currents. Output voltage is internally programmable in a range from 1.5V to 7.0V in increments of 0.1V (accuracy:  $\pm 2.5\%$ ). Maximum oscillation frequency is set to 100kHz for XC9110/9111 series. (At light loads, it is set to 180kHz for the XC9111 series.) Options include products equipped with a CE pin (C and D versions) that allows the IC to be shut down thereby reducing supply current and with separated  $V_{DD}/V_{OUT}$  pins (E and F versions) to separate the power supply block and the output voltage detect block. With the XC9110 series, maximum duty cycle is set to 75% ( $V_{DD}=3.3V$ ) making it suitable for use with large current operations. The XC9111 series automatically switches duty ratio between 56% & 75% ( $V_{DD}=3.3V$ ) when it senses changes in load to drop output ripple voltage and can support both large and small currents. The external transistor types (B/D/F types) can be provided for applications, which require larger currents.

### ■ APPLICATIONS

- Smart phones / Mobile phones
- Note PCs / Tablet PCs
- Digital still cameras / Camcorders
- Mobile devices / terminals

### ■ FEATURES

<b>Input Voltage Range</b>	: operating hold voltage	0.7V~10.0V
	Start-up voltage	0.9V~10.0V
<b>Output Voltage Range</b>	: 1.5V~7.0V in 0.1V increments	
<b>Output Accuracy</b>	: $\pm 2.5\%$	
<b>Max Oscillation Frequency</b>	: 100 kHz $\pm 15\%$	
	180 kHz (at 56% duty of XC9111)	
<b>Built-in Switch Types</b>	: A/C/E type	
<b>N-ch FET On-Resistance</b>	: $2.5\Omega @ V_{DD}=3.0V$	
<b>External Transistor Types</b>	: B/D/F type	
<b>Lx Limit Voltage</b>	: E type: more than $V_{DD}=2.0V$	
	: A/C type: more than $V_{OUT}=2.0V$	
<b>Max Duty Cycles</b>	: 75% (for XC9110)	
	: 56%/75% two steps (for XC9111)	
<b>Low Supply Current</b>	: $2.0\mu A @ V_{OUT}=3V$	
<b>Operating Ambient Temperature:</b>	-40°C ~ +85°C	
<b>Packages</b>	: SOT-23, SOT-89 (for XC9111), SOT-25, USP-6C	

### ■ TYPICAL APPLICATION CIRCUIT

- C type circuit



### ■ TYPICAL PERFORMANCE CHARACTERISTICS



## ■ BLOCK DIAGRAMS

### ● XC9111 A and B series



Note: The XC9110 series, Tr. Built-in type, uses the Lx pin and the XC9111 series, external Tr. Type, uses the EXT pin. The duty ratio of the XC9111 series automatically varies between 56% (oscillation frequency 180kHz) and 75% (oscillation frequency ( $f_{osc}$ ) 100kHz). The VLx limit function only applies to the XC9110/9111 A types.  
 \* The duty ratio depends on power supply. Please refer to the electrical characteristics on duty against output voltage you use.

### ● XC9110 / 9111 C and D series

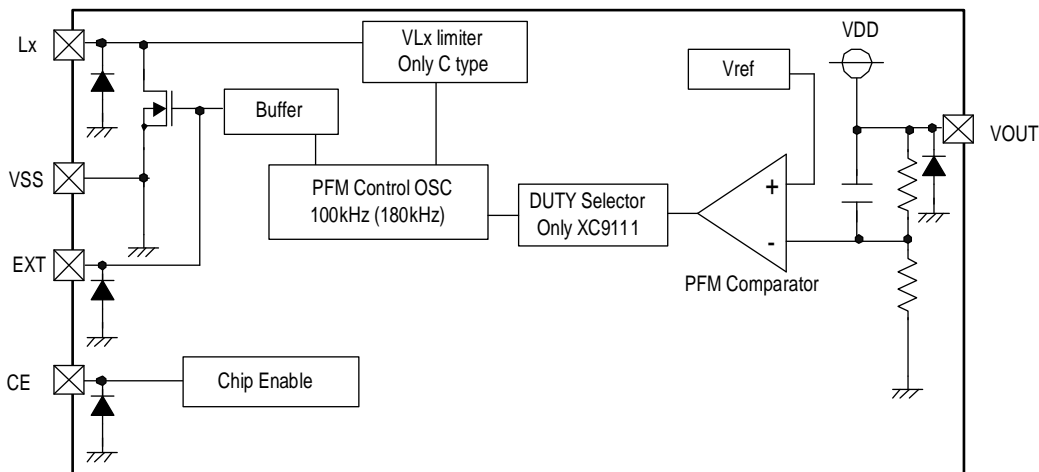

Note: The XC9110 series, Tr. Built-in type, uses the Lx pin and the XC9111 series, external Tr. Type, uses the EXT pin. The XC9110 series' duty ratio is 75% and oscillation frequency ( $f_{osc}$ ) is 100kHz. The duty ratio of the XC9111 series automatically varies between 56% (oscillation frequency 180kHz) and 75% (oscillation frequency ( $f_{osc}$ ) 100kHz). The VLx limit function only applies to the XC9110/9111 C versions.  
 \* The duty ratio depends on power supply. Please refer to the electrical characteristics on duty against output voltage you use.

**■ BLOCK DIAGRAMS**

● XC9111 E and F series

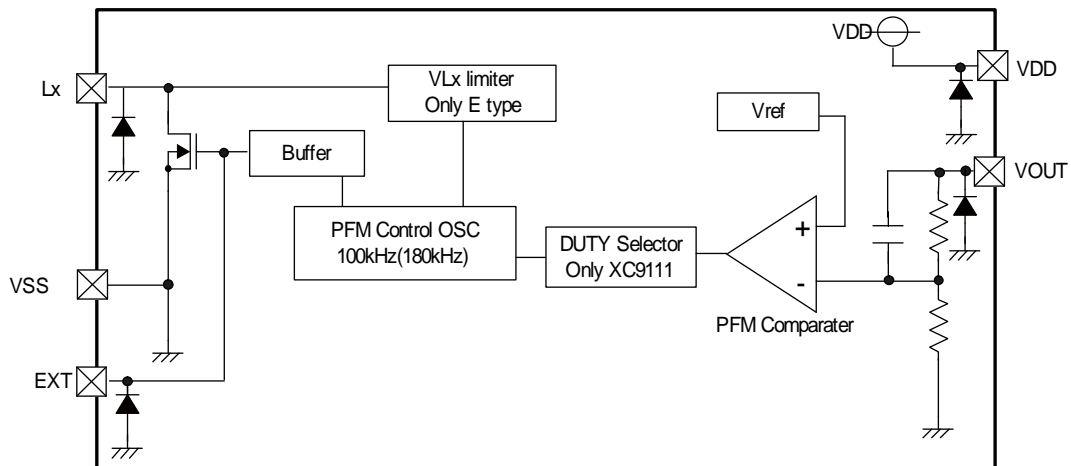

Note: The XC9110 series, Tr. Built-in type, uses the Lx pin and the XC9111 series, external Tr. Type, uses the EXT pin. The XC9110 / 9111 series E and F series have the V<sub>DD</sub> pin. The XC9110 series' duty ratio is 75% and oscillation frequency ( $f_{osc}$ ) is 100kHz. The duty ratio of the XC9111 series automatically varies between 56% (oscillation frequency 180kHz) and 75% (oscillation frequency ( $f_{osc}$ ) 100kHz). The VL<sub>x</sub> limit function only applies to the XC9110/9111 C versions.

\* The duty ratio depends on power supply.

Please refer to the electrical characteristics on duty against output voltage you use.

## PRODUCT CLASSIFICATION

### Ordering Information

XC9110①②③④⑤⑥-⑦ : PFM control, 75% duty

XC9111①②③④⑤⑥-⑦ : PFM control, 56% / 75% duty variable

DESIGNATOR	ITEM	SYMBOL	DESCRIPTION
①	CE Function	A	V <sub>DD</sub> / V <sub>OUT</sub> common type (for XC9111series) Built-in Transistor
		B	V <sub>DD</sub> / V <sub>OUT</sub> common type (for XC9111series) External Transistor
		C	CE pin (5 pin) Built-in Transistor
		D	CE pin (5 pin) External Transistor
		E	V <sub>DD</sub> / V <sub>OUT</sub> separated type (5 pin) Built-in Transistor
		F	V <sub>DD</sub> / V <sub>OUT</sub> separated type (5 pin) External Transistor
②③	Output Voltage	15 ~ 70	ex. 3.5V output → ②= 3, ③= 5
④	Maximum Oscillation Frequency	1	100kHz
⑤⑥-⑦ <sup>(*)</sup>	Packages (Order Unit)	MR	①=A ~ B SOT-23 (3,000pcs/Reel) ①=C ~ F SOT-25 (3,000pcs/Reel)
		MR-G	①=A ~ B SOT-23 (3,000pcs/Reel) ①=C ~ F SOT-25 (3,000pcs/Reel)
		PR	①=A ~ B SOT-89 (1,000pcs/Reel)
		PR-G	①=A ~ B SOT-89 (1,000pcs/Reel)
		ER	①=C ~ F USP-6C (3,000pcs/Reel)
		ER-G	①=C ~ F USP-6C (3,000pcs/Reel)

(\*) The "-G" suffix denotes Halogen and Antimony free as well as being fully EU RoHS compliant.

### Selection Guide



## PIN CONFIGURATION



\*The dissipation pad for the USP-6C package should be solder-plated in recommended mount pattern and metal masking so as to enhance mounting strength and heat release. If the pad needs to be connected to other pins, it should be connected to the pin No.1.

## PIN ASSIGNMENT

### ●XC9111A/B

PIN NUMBER				PIN NAME	FUNCTIONS
SOT-23		SOT-89			
A	B	A	B		
1	1	1	1	VSS	Ground
3	3	2	2	VOUT	Output Voltage Monitor, Internal Power Supply
2	-	3	-	LX	Switch
-	2	-	3	EXT	External Switching transistor drive <N-ch transistor drive>

### ●XC9110//9111C/D/E/F

PIN NUMBER								PIN NAME	FUNCTIONS
SOT-25				USP-6C					
C	D	E	F	C	D	E	F		
-	-	2	2	-	-	1	1	VDD	Internal Power Supply
4	4	4	4	6	6	6	6	VSS	Ground
-	5	-	5	-	4	-	4	EXT	External switching transistor drive <Connect to the gate pin of N-ch Power MOSFET>
5	-	5	-	4	-	4	-	Lx	Switch
1	1	-	-	3	3	-	-	CE	Chip Enable <Connect to the VOUT pin when Active and the VSS pin when stand-by>
2	2	1	1	1	1	3	3	VOUT	Output voltage monitor
3	3	3	3	2,5	2,5	2,5	2,5	NC	No connection

## ABSOLUTE MAXIMUM RATINGS

Ta = 25°C

PARAMETER		SYMBOL	RATINGS	UNITS
V <sub>OUT</sub> Input Voltage		V <sub>OUT</sub>	-0.3 ~ 12.0	V
Lx Pin Voltage		V <sub>Lx</sub>	-0.3 ~ 12.0	V
Lx Pin Current		I <sub>Lx</sub>	400	mA
EXT Pin Voltage		V <sub>EXT</sub>	V <sub>SS</sub> - 0.3 ~ V <sub>OUT</sub> + 0.3	V
EXT Pin Current		I <sub>EXT</sub>	±100	mA
CE Input Voltage		V <sub>CE</sub>	-0.3 ~ 12.0	V
V <sub>DD</sub> Input Voltage		V <sub>DD</sub>	-0.3 ~ 12.0	V
Power Dissipation	SOT-23 SOT-25	P <sub>d</sub>	250	mW
			500 (40mm x 40mm Standard board) <sup>(*)</sup>	
			600 (40mm x 40mm Standard board) <sup>(*)</sup>	
			760 (JESD51-7 board) <sup>(*)</sup>	
	SOT-89		500	
			1000 (40mm x 40mm Standard board) <sup>(*)</sup>	
	USP-6C		120	
			1000 (40mm x 40mm Standard board) <sup>(*)</sup>	
Operating Ambient Temperature		T <sub>opr</sub>	-40 ~ +85	°C
Storage Temperature		T <sub>stg</sub>	-55 ~ +125	°C

\* Define as V<sub>SS</sub> with a standard of all the voltage.

<sup>(\*)</sup> The power dissipation figure shown is PCB mounted and is for reference only.

The mounting condition is please refer to PACKAGING INFORMATION.

## ELECTRICAL CHARACTERISTICS

XC9111Axx1MR

Ta = 25°C

PARAMETER	SYMBOL	CONDITIONS	MIN.	TYP.	MAX.	UNIT	CIRCUIT
Output Voltage	V <sub>OUT</sub>	Connected to external components	× 0.975	V <sub>OUT</sub>	× 1.025	V	①
Output Voltage Temperature Characteristics	$\frac{\Delta V_{OUT}}{\Delta V_{OUT} \cdot \Delta T_{opr}}$	Connected to external components - 40°C ≤ T <sub>opr</sub> ≤ 85°C	-	± 100	-	ppm/°C	①
Maximum Input Voltage	V <sub>IN</sub>		10	-	-	V	①
Operating Start Voltage	V <sub>ST1</sub>	I <sub>OUT</sub> =1mA, Connected to external components	-	0.8	0.9	V	①
Oscillation Start Voltage	V <sub>ST2</sub>	Applied 0.8V to V <sub>OUT</sub> , V <sub>PULL</sub> =1.0V	-	-	0.8	V	②
Operating Hold Voltage	V <sub>HLD</sub>	I <sub>OUT</sub> =1mA, Connected to external components	0.7	-	-	V	①
Input Current at No Load	I <sub>IN</sub>	I <sub>OUT</sub> =0mA (*1)	-	E1-1	E1-2	μA	①
Supply Current 1 (*2)	I <sub>DD1</sub>	Applied (output voltage × 0.95) to V <sub>OUT</sub>	-	E2-1	E2-2	μA	②
Supply Current 2	I <sub>DD2</sub>	Applied (output voltage+0.5) to V <sub>OUT</sub>	-	E3-1	E3-2	μA	②
Lx Switch ON Resistance	R <sub>SWON</sub>	Same as I <sub>DD1</sub> , V <sub>Lx</sub> =0.4V (*3)	-	E4-1	E4-2	Ω	②
Lx Leak Current	I <sub>LxL</sub>	Same as I <sub>DD2</sub> , V <sub>Lx</sub> =7V	-	-	1	μA	③
Duty Ratio	DTY	Same as I <sub>DD1</sub> , measure Lx waveform	E7-1	E7-2	E7-3	%	②
Duty Ratio 2	DTY2	I <sub>OUT</sub> =1mA, measure Lx ON time. Connect to external components	48	56	64	%	①
Maximum Oscillation Frequency	f <sub>OSCMAX</sub>	Same as I <sub>DD1</sub>	85	100	115	kHz	②
Maximum Oscillation Frequency 2	f <sub>OSCMAX2</sub>	Same as I <sub>DD1</sub>	153	180	207	kHz	②
Lx Limit Voltage (*4)	V <sub>LxLMT</sub>	Same as I <sub>DD1</sub> , V <sub>Lx</sub> when max. oscillation frequency is more than double	0.7	-	1.1	V	②
Efficiency (*5)	EFFI	Connect to external components	-	E8	-	%	①

Test condition : Unless otherwise specified, V<sub>IN</sub>=V<sub>OUT</sub> × 0.6, I<sub>OUT</sub>=<C1(\*)>, V<sub>PULL</sub>=5.0V

NOTE:

- \*1: TOREX SBD, XBS104S14R-G is used, reverse current I<sub>R</sub> < 1 μA (when reverse voltage V<sub>R</sub> = 10V is applied), in case of using selected parts.
- \*2: Supply Current 1 is the value when the IC is constantly switching. In actual operation, the oscillator periodically switches, resulting in lower power consumption. Please refer to Input Current (I<sub>IN</sub>) under no load condition for the actual current, which is supplied from the input power supply (V<sub>IN</sub>).
- \*3: Lx switch ON resistance can be calculated by (V<sub>Lx</sub> × R<sub>p</sub>) / (V<sub>PULL</sub> - V<sub>Lx</sub>). \* Change V<sub>PULL</sub> so that V<sub>Lx</sub> will become 0.4V.
- \*4: The Lx limit voltage function becomes stable when V<sub>OUT</sub> is over 2.0V.
- \*5: EFFI = {[output voltage] × (output current)} / {[input voltage] × (input current)} × 100
- \*6: Please be aware of the absolute maximum ratings of the external components.

## ELECTRICAL CHARACTERISTICS (Continued)

XC9111Bxx1MR

Ta = 25°C

PARAMETER	SYMBOL	CONDITIONS	MIN.	TYP.	MAX.	UNIT	CIRCUIT
Output Voltage	V <sub>OUT</sub>	Connected to external components	× 0.975	V <sub>OUT</sub>	× 1.025	V	⑥
Output Voltage Temperature Characteristics	$\frac{\Delta V_{OUT}}{\Delta V_{OUT} \cdot \Delta T_{opr}}$	Connected to external components - 40°C ≤ T <sub>opr</sub> ≤ 85°C	-	± 100	-	ppm/°C	⑥
Maximum Input Voltage	V <sub>IN</sub>		10	-	-	V	-
Operating Start Voltage	V <sub>ST1</sub>	I <sub>OUT</sub> =1mA, Connected to external components	-	0.8	0.9	V	⑥
Oscillation Start Voltage	V <sub>ST2</sub>	Applied 0.8V to V <sub>OUT</sub>	-	-	0.8	V	⑦
Operation Hold Voltage	V <sub>HLD</sub>	I <sub>OUT</sub> =1mA, Connected to external components	0.7	-	-	V	⑥
Supply Current 1 (*1)	I <sub>DD1</sub>	Applied (output voltage × 0.95) to V <sub>OUT</sub>	-	E2-1	E2-2	μA	⑦
Supply Current 2	I <sub>DD2</sub>	Applied (output voltage+0.5) to V <sub>OUT</sub>	-	E3-1	E3-2	μA	⑦
EXT 'H' ON Resistance	R <sub>EXTH</sub>	Same as I <sub>DD1</sub> , V <sub>EXT</sub> =V <sub>OUT</sub> -0.4V (*2)	-	E5-1	E5-2	Ω	②
EXT 'L' ON Resistance	R <sub>EXTL</sub>	Same as I <sub>DD1</sub> , V <sub>EXT</sub> =0.4V (*3)	-	E6-1	E6-2	Ω	②
Duty Ratio	DTY	Same as I <sub>DD1</sub> , measure Lx waveform	E7-1	E7-2	E7-3	%	⑦
Duty Ratio 2	DTY2	I <sub>OUT</sub> =1mA, measure Lx ON time. Connect to external components	48	56	64	%	⑥
Maximum Oscillation Frequency	f <sub>OSCMAX</sub>	Same as I <sub>DD1</sub>	85	100	115	kHz	⑦
Maximum Oscillation Frequency 2	f <sub>OSCMAX2</sub>	Same as I <sub>DD1</sub>	153	180	207	kHz	⑦
Efficiency (*4)	EFFI	Connect to external components	-	E9	-	%	⑥

Test condition : Unless otherwise specified, V<sub>IN</sub>=V<sub>OUT</sub> × 0.6, I<sub>OUT</sub>=<C1(\*)>

NOTE:

\*1: Supply Current 1 is the value when the IC is constantly switching. In actual operation, the oscillator periodically switches, resulting in lower power consumption.

\*2: EXT 'H' ON resistance can be calculated by  $(0.4 \times R_p) / (V_{EXT} - V_{pull})$ . \* Change V<sub>pull</sub> so that V<sub>EXT</sub> will become V<sub>OUT</sub>-0.4V.

\*3: EXT 'L' ON resistance can be calculated by  $(V_{EXT} \times R_p) / (V_{pull} - V_{EXT})$ . \* Change V<sub>pull</sub> so that V<sub>EXT</sub> will become 0.4V.

\*4: EFFI={ [output voltage] × (output current) } / [ (input voltage) × (input current) ] × 100

\*5: Please be aware of the absolute maximum ratings of the external components.



## ■ ELECTRICAL CHARACTERISTICS (Continued)

XC9110Cxx1MR, XC9111Cxx1MR

Ta = 25°C

PARAMETER	SYMBOL	CONDITIONS	MIN.	TYP.	MAX.	UNIT	CIRCUIT
Output Voltage	V <sub>OUT</sub>	Connect to external components	× 0.975	V <sub>OUT</sub>	× 1.025	V	①
Output Voltage Temperature Characteristics	$\Delta V_{OUT}$ $\Delta V_{OUT} \cdot \Delta T_{opr}$	Connect to external components - 40°C ≤ T <sub>opr</sub> ≤ 85°C	-	± 100	-	ppm/°C	①
Maximum Input Voltage	V <sub>IN</sub>		10	-	-	V	①
Operation Start Voltage	V <sub>ST1</sub>	I <sub>OUT</sub> =1mA, connect to external components	-	0.8	0.9	V	①
Oscillation Start Voltage	V <sub>ST2</sub>	Applied 0.8V to V <sub>OUT</sub> , V <sub>pull</sub> =1.0V	-	-	0.8	V	②
Operation Hold Voltage	V <sub>HLD</sub>	I <sub>OUT</sub> =1mA, connect to external components	0.7	-	-	V	①
Input Current	I <sub>IN</sub>	I <sub>OUT</sub> =0mA (*1)	-	E1-1	E1-2	μA	①
Supply Current 1 (*2)	I <sub>DD1</sub>	Applied (output voltage × 0.95) to V <sub>OUT</sub>	-	E2-1	E2-2	μA	②
Supply Current 2	I <sub>DD2</sub>	Applied (output voltage + 0.5V) to V <sub>OUT</sub>	-	E3-1	E3-2	μA	②
Lx Switch ON Resistance	R <sub>SWON</sub>	Same as I <sub>DD1</sub> , V <sub>Lx</sub> =0.4V (*3)	-	E4-1	E4-2	Ω	②
Lx Leak Current	I <sub>LxL</sub>	Same as I <sub>DD2</sub> , V <sub>Lx</sub> =7V	-	-	1	μA	③
Duty Ratio	DTY	Same as I <sub>DD1</sub> , measure Lx waveform	E7-1	E7-2	E7-3	%	②
Duty Ratio 2	DTY2	I <sub>OUT</sub> =1mA, measure Lx ON time (XC9111 only) Connect to external components	48	56	64	%	①
Maximum Oscillation Frequency	f <sub>OSCMAX</sub>	Same as I <sub>DD1</sub>	85	100	115	kHz	②
Maximum Oscillation Frequency 2	f <sub>OSCMAX2</sub>	Same as I <sub>DD1</sub> (XC9111 only)	153	180	207	kHz	②
Stand-by Current	I <sub>STB</sub>	Same as I <sub>DD1</sub> , V <sub>CE</sub> =0V	-	-	0.50	μA	④
CE "High" Voltage	V <sub>CEH</sub>	Same as I <sub>DD1</sub> , determine Lx oscillation	0.75	-	-	V	④
CE "Low" Voltage	V <sub>CEL</sub>	Same as I <sub>DD1</sub> , determine Lx shut-down	-	-	0.20	V	④
CE "High" Current	I <sub>CEH</sub>	Same as I <sub>DD1</sub> , V <sub>CE</sub> =V <sub>OUT</sub> × 0.95	-	-	0.25	μA	⑤
CE "Low" Current	I <sub>CEL</sub>	Same as I <sub>DD1</sub> , V <sub>CE</sub> =0V	-	-	-0.25	μA	⑤
Lx Limit Voltage (*4)	V <sub>LxLMT</sub>	Same as I <sub>DD1</sub> , when max. oscillation frequency is more than double.	0.7	-	1.1	V	②
Efficiency (*5)	EFFI	Connect to external components	-	E8	-	%	①

Test condition : Unless otherwise specified, connect CE to V<sub>OUT</sub>, V<sub>IN</sub>=V<sub>OUT</sub> × 0.6, I<sub>OUT</sub>=<C1(\*)>, V<sub>pull</sub>=5.0V

NOTE:

- \*1: TOREX SD, XBS104S14R-G is used, reverse current I<sub>R</sub> < 1 μA (when reverse voltage V<sub>R</sub> = 10V is applied), in case of using selected parts.
- \*2: Supply Current 1 is the value when the IC is constantly switching. In actual operation, the oscillator periodically switches, resulting in lower power consumption. Please refer to Input Current (I<sub>IN</sub>) under no load condition for the actual current, which is supplied from the input power supply (V<sub>IN</sub>).
- \*3: Lx switch ON resistance can be calculated by (V<sub>Lx</sub> × R<sub>p</sub>) / (V<sub>pull</sub> - V<sub>Lx</sub>). \* Change V<sub>pull</sub> so that V<sub>Lx</sub> will become 0.4V.
- \*4: The Lx. limit voltage function becomes stable when V<sub>OUT</sub> of the XC9110/9111 series is over 2.0V.
- \*5: EFFI=[(output voltage) × (output current)] / [(input voltage) × (input current)] × 100
- \*6: Please be aware of the absolute maximum ratings of the external components.

## ELECTRICAL CHARACTERISTICS (Continued)

XC9110Dxx1MR, XC9111Dxx1MR

Ta = 25°C

PARAMETER	SYMBOL	CONDITIONS	MIN.	TYP.	MAX.	UNIT	CIRCUIT
Output Voltage	V <sub>OUT</sub>	Connect to external components	× 0.975	V <sub>OUT</sub>	× 1.025	V	⑥
Output Voltage Temperature Characteristics	$\frac{\Delta V_{OUT}}{\Delta V_{OUT} + \Delta T_{opr}}$	Connect to external components - 40°C ≤ T <sub>opr</sub> ≤ 85°C	-	± 100	-	ppm/°C	⑥
Maximum Input Voltage	V <sub>IN</sub>		10	-	-	V	-
Operation Start Voltage	V <sub>ST1</sub>	I <sub>OUT</sub> =1mA, connect to external components	-	0.8	0.9	V	⑥
Oscillation Start Voltage	V <sub>ST2</sub>	Applied 0.8V to V <sub>OUT</sub>	-	-	0.8	V	⑦
Operation Hold Voltage	V <sub>HLD</sub>	I <sub>OUT</sub> =1mA, connect to external components	0.7	-	-	V	⑥
Supply Current 1 (*1)	I <sub>DD1</sub>	Applied (output voltage × 0.95) to V <sub>OUT</sub>	-	E2-1	E2-2	μA	⑦
Supply Current 2	I <sub>DD2</sub>	Applied (output voltage + 0.5V) to V <sub>OUT</sub>	-	E3-1	E3-2	μA	⑦
EXT H ON Resistance	R <sub>EXTH</sub>	Same as I <sub>DD1</sub> , V <sub>EXT</sub> =V <sub>OUT</sub> -0.4(*2)	-	E5-1	E5-2	Ω	②
EXT L ON Resistance	R <sub>EXTL</sub>	Same as I <sub>DD1</sub> , V <sub>EXT</sub> =0.4V(*3)	-	E6-1	E6-2	Ω	②
Duty Ratio	DTY	Same as I <sub>DD1</sub> , measure Lx waveform	E7-1	E7-2	E7-3	%	⑦
Duty Ratio 2	DTY2	I <sub>OUT</sub> =1mA, measure Lx ON time (XC9111 only) Connect to external components	48	56	64	%	⑥
Maximum Oscillation	f <sub>OSCMAX</sub>	Same as I <sub>DD1</sub>	85	100	115	kHz	⑦
Maximum Oscillation	f <sub>OSCMAX2</sub>	Same as I <sub>DD1</sub> (XC9111 only)	153	180	207	kHz	⑦
Standby Current	I <sub>STB</sub>	Same as I <sub>DD1</sub> , V <sub>CE</sub> =0V	-	-	0.50	μA	⑤
CE "High" Voltage	V <sub>CEH</sub>	Same as I <sub>DD1</sub> , determine Lx oscillation	0.75	-	-	V	⑧
CE "Low" Voltage	V <sub>CEL</sub>	Same as I <sub>DD1</sub> , determine Lx shut-down	-	-	0.20	V	⑧
CE "High" Current	I <sub>CEH</sub>	Same as I <sub>DD1</sub> , V <sub>CE</sub> =V <sub>OUT</sub> × 0.95	-	-	0.25	μA	⑤
CE "Low" Current	I <sub>CEL</sub>	Same as I <sub>DD1</sub> , V <sub>CE</sub> =0V	-	-	-0.25	μA	⑤
Efficiency (*4)	EFFI	Connect to external components	-	E9	-	%	⑥

Test condition : Unless otherwise specified, connect CE to V<sub>OUT</sub>, V<sub>IN</sub>=V<sub>OUT</sub> × 0.6, I<sub>OUT</sub>=<C1(\*)>

**NOTE:**

- \*1: "Supply Current 1" is the value when the IC is constantly switching. In actual operation, the oscillator periodically switches, resulting in lower power consumption.
- \*2: EXT H ON resistance can be calculated by  $(0.4 \times R_p) / (V_{EXT} - V_{pull})$ . \* Change V<sub>pull</sub> so that V<sub>EXT</sub> will become V<sub>OUT</sub>-0.4V.
- \*3: EXT L ON resistance can be calculated by  $(V_{EXT} \times R_p) / (V_{pull} - V_{EXT})$ . \* Change V<sub>pull</sub> so that V<sub>EXT</sub> will become 0.4V.
- \*4: EFFI={ [output voltage] × (output current) } / [ (input voltage) × (input current) ] × 100
- \*5: Please be aware of the absolute maximum ratings of the external components.

## ■ ELECTRICAL CHARACTERISTICS (Continued)

XC9110Exx1MR, XC9111Exx1MR

Ta = 25°C

PARAMETER	SYMBOL	CONDITIONS	MIN.	TYP.	MAX.	UNIT	CIRCUIT
Output Voltage	V <sub>OUT</sub>	Connect to external components	× 0.975	V <sub>OUT</sub>	× 1.025	V	①
Output Voltage Temperature Characteristics	$\frac{\Delta V_{OUT}}{\Delta V_{OUT} \cdot \Delta T_{opr}}$	Connect to external components - 40°C ≤ T <sub>opr</sub> ≤ 85°C	-	± 100	-	ppm/°C	①
Maximum Input Voltage	V <sub>IN</sub>		10	-	-	V	-
Operation Start Voltage	V <sub>ST1</sub>	I <sub>OUT</sub> =1mA, connect to external components	-	0.8	0.9	V	①
Oscillation Start Voltage	V <sub>ST2</sub>	Applied 0.8V to V <sub>OUT</sub> , V <sub>PULL</sub> =1.0V	-	-	0.8	V	②
Operation Hold Voltage	V <sub>HLD</sub>	I <sub>OUT</sub> =1mA, connect to external components	0.7	-	-	V	①
Input Current	I <sub>IN</sub>	I <sub>OUT</sub> =0mA (*1)	-	E1-1	E1-2	μA	①
Supply Current 1 (*2)	I <sub>DD1</sub>	Applied (output voltage × 0.95) to V <sub>OUT</sub>	-	E2-1	E2-2	μA	②
Supply Current 2	I <sub>DD2</sub>	Applied (output voltage + 0.5V) to V <sub>OUT</sub>	-	E3-1	E3-2	μA	②
Lx Switch ON Resistance	R <sub>SWON</sub>	Same as I <sub>DD1</sub> , V <sub>LX</sub> =0.4V (*3)	-	E4-1	E4-2	Ω	②
Lx Leak Current	I <sub>LXL</sub>	Same as I <sub>DD2</sub> , V <sub>LX</sub> =7V	-	-	1	μA	③
Duty Ratio	DTY	Same as I <sub>DD1</sub> , measure Lx waveform	E7-1	E7-2	E7-3	%	②
Duty Ratio 2	DTY2	I <sub>OUT</sub> =1mA, measure Lx ON time (XC9111 only) Connect to external	48	56	64	%	①
Maximum Oscillation	f <sub>OSCMAX</sub>	Same as I <sub>DD1</sub>	85	100	115	kHz	②
Maximum Oscillation	f <sub>OSCMAX 2</sub>	Same as I <sub>DD1</sub> (XC9111 only)	153	180	207	kHz	②
Lx Limit Voltage (*4)	V <sub>LXLMT</sub>	Same as I <sub>DD1</sub> , V <sub>LX</sub> when max. oscillation frequency is more than double.	0.7	-	1.1	V	②
Efficiency (*5)	EFFI	Connect to external components	-	E8	-	%	①

Test condition : Unless otherwise specified, connect V<sub>DD</sub> to V<sub>OUT</sub>, V<sub>IN</sub>=V<sub>OUT</sub> × 0.6, I<sub>OUT</sub>=<C1(\*)>, V<sub>PULL</sub>=5.0V

### NOTE:

- \*1: TOREX SD, XBS104S14R-G is used; reverse current I<sub>R</sub> < 1 μA (when reverse voltage V<sub>R</sub> = 10V is applied), in case of using selected parts.
- \*2: "Supply Current 1" is the value when the IC is constantly switching. In actual operation, the oscillator periodically switches, resulting in lower power consumption. Please refer to Input Current (I<sub>IN</sub>) under no load condition for the actual current, which is supplied from the input power supply (V<sub>IN</sub>).
- \*3: Lx switch ON resistance can be calculated by (V<sub>LX</sub> × R<sub>p</sub>) / (V<sub>PULL</sub> - V<sub>LX</sub>). \* Change V<sub>PULL</sub> so that V<sub>LX</sub> will become 0.4V.
- \*4: The Lx limit voltage function becomes stable when V<sub>OUT</sub> of the XC9110/9111 series is over 2.0V.
- \*5: EFFI={ [output voltage] × (output current) } / [ (input voltage) × (input current) ] × 100
- \*6: When using V<sub>DD</sub> and V<sub>OUT</sub> separately, please set the voltage range of V<sub>DD</sub> from 1.5V to 10V.  
The IC operates from V<sub>DD</sub>=0.8V, but output voltage and oscillation frequency will be stable when V<sub>DD</sub>=1.5V or more.
- \*7: Please be aware of the absolute maximum ratings of the external components.

## ELECTRICAL CHARACTERISTICS (Continued)

XC9110Fxx1MR, XC9111Fxx1MR

Ta = 25°C

PARAMETER	SYMBOL	CONDITIONS	MIN.	TYP.	MAX.	UNIT	CIRCUIT
Output Voltage	V <sub>OUT</sub>	Connect to external components	× 0.975	V <sub>OUT</sub>	× 1.025	V	⑥
Output Voltage Temperature Characteristics	$\Delta V_{OUT}$ $\Delta V_{OUT} \cdot \Delta t_{opr}$	Connect to external components - 40°C ≤ T <sub>opr</sub> ≤ 85°C	-	± 100	-	ppm/ °C	⑥
Maximum Input Voltage	V <sub>IN</sub>		10	-	-	V	-
Operation Start Voltage	V <sub>ST1</sub>	I <sub>OUT</sub> =1mA, connect to external components	-	0.8	0.9	V	⑥
Oscillation Start Voltage	V <sub>ST2</sub>	Applied 0.8V to V <sub>OUT</sub>	-	-	0.8	V	⑦
Operation Hold Voltage	V <sub>HLD</sub>	I <sub>OUT</sub> =1mA, connect to external components	0.7	-	-	V	⑥
Supply Current 1 (*1)	I <sub>DD1</sub>	Applied (output voltage × 0.95) to V <sub>OUT</sub>	-	E2-1	E2-2	μA	⑦
Supply Current 2	I <sub>DD2</sub>	Applied (output voltage + 0.5V) to V <sub>OUT</sub>	-	E3-1	E3-2	μA	⑦
EXT H ON Resistance	R <sub>EXTH</sub>	Same as I <sub>DD1</sub> , V <sub>EXT</sub> =V <sub>OUT</sub> -0.4V (*2)	-	E5-1	E5-2	Ω	②
EXT L ON Resistance	R <sub>EXTL</sub>	Same as I <sub>DD1</sub> , V <sub>EXT</sub> =0.4V (*3)	-	E6-1	E6-2	Ω	②
Duty Ratio	DTY	Same as I <sub>DD1</sub> , measure Lx waveform	E7-1	E7-2	E7-3	%	⑦
Duty Ratio 2	DTY2	I <sub>OUT</sub> =1mA, measure Lx ON time (XC9111 only) Connect to external	48	56	64	%	⑥
Maximum Oscillation	f <sub>OSCMAX</sub>	Same as I <sub>DD1</sub>	85	100	115	kHz	⑦
Maximum Oscillation	f <sub>OSCMAX 2</sub>	Same as I <sub>DD1</sub> (XC9111 only)	153	180	207	kHz	⑦
Efficiency (*4)	EFFI	Connect to external components	-	E9	-	%	⑥

Test condition : Unless otherwise specified, connect V<sub>DD</sub> to V<sub>OUT</sub>, V<sub>IN</sub>=V<sub>OUT</sub> × 0.6, I<sub>OUT</sub>=<C1(\*)>

NOTE:

\*1: "Supply Current 1" is the value when the IC is constantly switching. In actual operation, the oscillator periodically switches, resulting in lower power consumption.

\*2: EXT H ON resistance can be calculated by  $(0.4 \times R_p) / (V_{EXT} - V_{pull})$ . \* Change V<sub>pull</sub> so that V<sub>EXT</sub> will become V<sub>OUT</sub>-0.4V.

\*3: EXT L ON resistance can be calculated by  $(V_{EXT} \times R_p) / (V_{pull} - V_{EXT})$ . \* Change V<sub>pull</sub> so that V<sub>EXT</sub> will become 0.4V.

\*4:  $EFFI = \frac{[\text{output voltage}] \times (\text{output current})}{[(\text{input voltage}) \times (\text{input current})]} \times 100$

\*5: When using V<sub>DD</sub> and V<sub>OUT</sub> separately, please set the voltage range of V<sub>DD</sub> from 1.5V to 10V.

The IC operates from V<sub>DD</sub>=0.8V, but output voltage and oscillation frequency will be stable when V<sub>DD</sub>=1.5V or more.

\*6: Please be aware of the absolute maximum ratings of the external components.

## ■ ELECTRICAL CHARACTERISTICS (Continued)

● IDD2, REXTH, REXTL, DTY Chart

SYMBOL	E2-1	E2-2	E1-1	E1-2	E3-1	E3-2	E4-1	E4-2	E5-1	E5-2	E6-1	E6-2
PARAMETER	Supply Current 1		Input Current (No Load)		Supply Current 2		Lx Switch ON Resistance		EXT H ON Resistance		EXT L ON Resistance	
UNIT	(μA)		(μA)		(μA)		(Ω)		(Ω)		(Ω)	
SETTING VOLTAGE	IDD1		IIN		IDD2		RSWON		REXTH		REXTL	
	TYP.	MAX.	TYP.	MAX.	TYP.	MAX.	TYP.	MAX.	TYP.	MAX.	TYP.	MAX.
1.5	7.7	15.1	4.3	8.6	1.9	3.5	4.2	6.3	160	240	67	101
1.6	8.0	15.6										
1.7	8.3	16.2										
1.8	8.6	16.8										
1.9	8.9	17.5										
2.0	9.3	18.2										
2.1	9.7	18.9	4.4	8.8	2.0	4.0	3.2	4.8	91	137	45	68
2.2	10.1	19.7										
2.3	10.5	20.6										
2.4	11.0	21.5										
2.5	11.5	22.5										
2.6	12.0	23.5										
2.7	12.5	24.5	4.6	9.3	2.1	4.2	2.8	4.2	70	105	38	57
2.8	13.1	25.6										
2.9	13.7	26.8										
3.0	14.3	28.0										
3.1	15.0	29.3										
3.2	15.7	30.6										
3.3	16.4	31.9	4.8	9.7	2.2	4.4	2.5	3.8	59	89	33	50
3.4	17.1	33.3										
3.5	17.8	34.8										
3.6	18.6	36.3										
3.7	19.4	37.9										
3.8	20.3	39.5										
3.9	21.1	41.1	5.0	10.0	2.3	4.5	2.1	3.2	40	60	24	36
4.0	22.0	42.8										
4.1	22.9	44.5										
4.2	23.8	46.3										
4.3	24.8	48.2										
4.4	25.7	50.0										
4.5	26.7	52.0	5.1	10.2	2.4	4.6	2.1	3.2	40	60	24	36
4.6	27.7	53.9										
4.7	28.8	56.0										
4.8	29.8	58.0										
4.9	30.9	60.1										
5.0	31.7	63.4										
5.1	32.3	64.7	5.2	10.4	2.5	4.7	2.1	3.2	40	60	24	36
5.2	32.9	65.9										
5.3	33.5	67.1										
5.4	34.1	68.3										
5.5	34.7	69.5										
5.6	35.3	70.7										
5.7	36.0	72.0	5.3	10.6	2.6	4.8	2.1	3.2	40	60	24	36
5.8	36.5	73.1										
5.9	37.1	74.3										
6.0	37.7	75.5										
6.1	38.4	76.8										
6.2	38.9	77.9										
6.3	39.5	79.1	5.4	10.8	2.7	4.9	2.1	3.2	40	60	24	36
6.4	40.2	80.4										
6.5	40.8	81.6										
6.6	41.3	82.7										
6.7	42.0	84.0										
6.8	42.6	85.2										
6.9	43.2	86.4										
7.0	43.7	87.5										

# XC9110/XC9111 Series

## ELECTRICAL CHARACTERISTICS (Continued)

● I<sub>OUT</sub>, DTY, EFFI Chart

SYMBOL	C1	E7-1	E7-2	E7-3	E8		E9	
					EFFICIENCY			
PARAMETER	OUTPUT CURRENT	DUTY RATIO			XC9110	XC9111	XC9110	XC9111
UNIT	(mA)	DUTY RATIO (%)			EFFICIENCY (%)			
SETTING VOLTAGE	I <sub>OUT</sub>	DTY			EFFI			
		MIN.	TYP.	MAX.	TYP.			
1.5	7.5	70	75	80	60	75	60	75
1.6	8.0							
1.7	8.5							
1.8	9.0							
1.9	9.5							
2.0	10.0							
2.1	10.5							
2.2	11.0							
2.3	11.5							
2.4	12.0							
2.5	12.5							
2.6	13.0							
2.7	13.5							
2.8	14.0							
2.9	14.5							
3.0	30.0							
3.1	31.0							
3.2	32.0							
3.3	33.0							
3.4	34.0							
3.5	35.0							
3.6	36.0							
3.7	37.0							
3.8	38.0							
3.9	39.0							
4.0	40.0							
4.1	41.0							
4.2	42.0							
4.3	43.0							
4.4	44.0							
4.5	45.0							
4.6	46.0							
4.7	47.0							
4.8	48.0							
4.9	49.0							
5.0	50.0							
5.1	51.0							
5.2	52.0							
5.3	53.0							
5.4	54.0							
5.5	55.0							
5.6	56.0							
5.7	57.0							
5.8	58.0							
5.9	59.0							
6.0	60.0							
6.1	61.0							
6.2	62.0							
6.3	63.0							
6.4	64.0							
6.5	65.0							
6.6	66.0							
6.7	67.0							
6.8	68.0							
6.9	69.0							
7.0	70.0							
		68	73	78	82	88	82	85

## TYPICAL APPLICATION CIRCUITS

●A type circuit

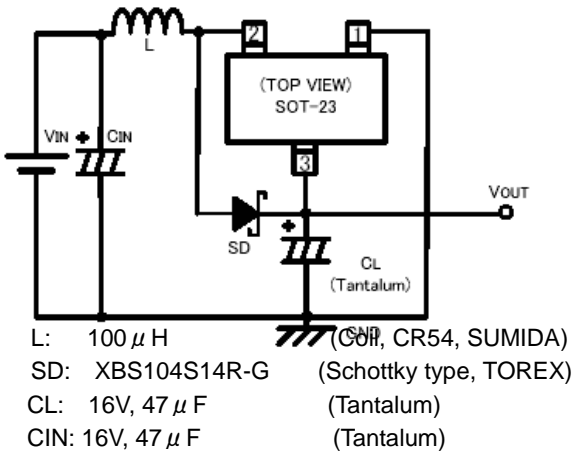

●B type circuit

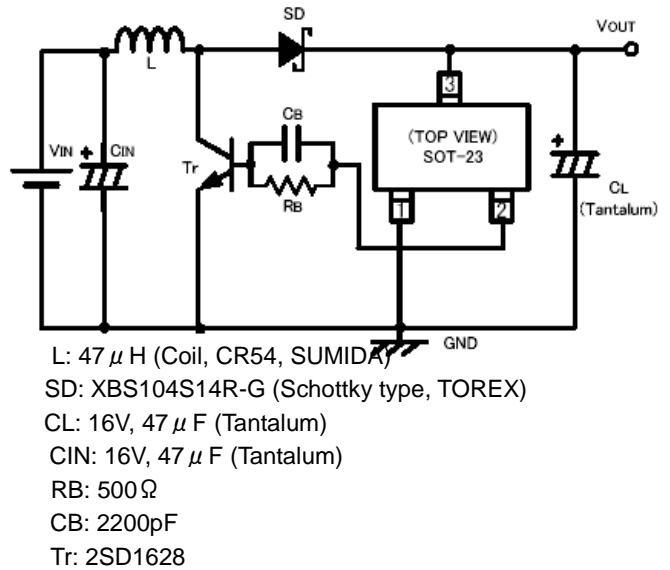

●C type circuit



●D type circuit

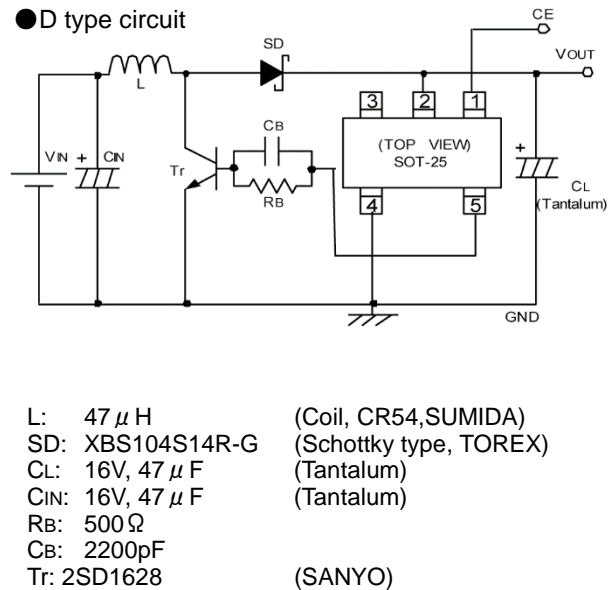

●E type circuit

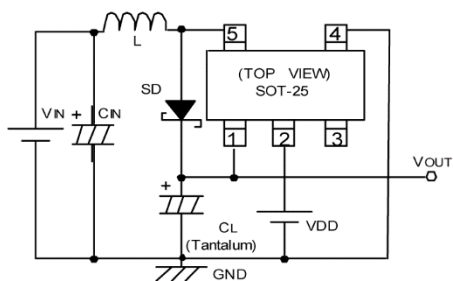

●F type circuit

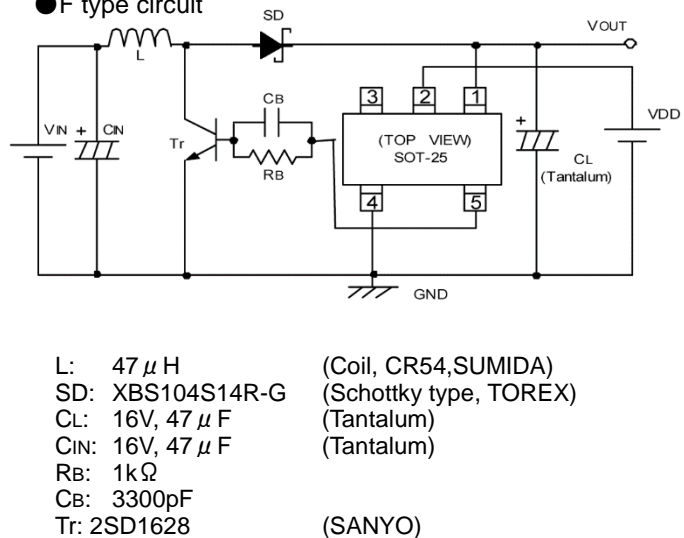

## ■ OPERATIONAL EXPLANATION

The XC9110/9111 series are PFM controlled step-up DC/DC converter (A, C and E types) / controller ICs (B, D and F types), which contain voltage reference source, PFM comparator, duty selector, PFM controlled OSC, VLx Limiter, driver transistor and so on. With the XC9110 series, maximum duty ratio is set to 75% (maximum oscillation frequency=MAX<sub>fosc</sub>: 100kHz) making it suitable for use with large current operations. The XC9111 series automatically switches duty ratio between 56% (MAX<sub>fosc</sub>: 180kHz) and 75% (MAX<sub>fosc</sub>: 100kHz) when it senses changes in load and can support both large and small currents.

### <Reference Voltage Source (Vref) >

The reference voltage source provides the reference voltage to ensure stable output voltage of the DC/DC converter.

### < PFM Comparator >

The PFM comparator compares the feedback voltage divided by the internal split resistors with the internal reference voltage. When the feedback voltage is higher than the reference voltage, PFM controlled OSC will be stopped. When the feedback voltage is lower than the reference voltage, the PFM controlled OSC will be operated so that the output voltage will be stable by sending a signal to the buffer drive circuit and controlling the internal or external driver transistor.

### < Duty Selector >

With the XC9111 series, the duty selector automatically switches duty ratio between 56% and 75% when it senses changes in load and can support both large and small currents.

### < PFM Controlled Oscillator >

The PFM controlled OSC determines maximum oscillation frequency. The circuit generates the oscillation frequency of 100kHz at 75% duty and 180kHz at 56%.

### < VLx Limiter>

The VLx circuit of the XC9110/9111 A, C and D types detects in-rush current and overcurrent, which flows from the VOUT pin to the Lx pin during short-circuit. In overcurrent, the driver transistor will be OFF. When the overcurrent state is eliminated, the IC resumes its normal operation.

### <Chip Enable Function>

The chip enable function of the XC9110/9111 C and D types enables the IC to be in shut down mode when a low level signal is input to the CE pin. During the shut down mode, the current consumption will be reduced to 0.5  $\mu$  A (MAX.).

### <Separated VDD/VOUT>

With the separated VDD pin, the XC9110/9111 E and F types can be operated in both low and high voltage.



## EXTERNAL COMPONENTS

Tr.: \*Using a MOSFET

XP151A13A0MR-G (N-ch Power MOSFET, TOREX)

Note : V<sub>GS</sub> breakdown voltage of this Transistor is 8V so please be careful with the power supply voltage.

If the power supply voltage is over 6V, Please use the XP151A12A2MR-G with a V<sub>GS</sub> breakdown voltage of 12V.

\* Using a NPN Transistor

2SD1628 (SANYO)

R<sub>B</sub>: 500Ω (Adjust in accordance with load and Tr's hFE.)

C<sub>B</sub>: 2200pF (Ceramic)

$C_B \leq 1 / (2TT \times R_B \times FOSC \times 0.7)$

### ● R<sub>B</sub> value example (when using NPN Transistor)

V <sub>OUT</sub> (V)	I <sub>OUT</sub> (mA)	V <sub>IN</sub> (V)	R <sub>B</sub> (Ω)	V <sub>OUT</sub> (V)	I <sub>OUT</sub> (mA)	V <sub>IN</sub> (V)	R <sub>B</sub> (Ω)
1.8	10	1.2	4.5	3.3	5	1.2	6.5
1.8	10	1.5	6.0	3.3	5	1.5	6.5
1.8	30	1.2	2.0	3.3	10	1.2	5.0
1.8	30	1.5	2.0	3.3	10	1.5	4.5
1.8	50	1.2	1.2	3.3	30	1.2	3.5
1.8	50	1.5	1.5	3.3	30	1.5	3.5

\* Tr.: 2SD1628

SD: XBS104S14R-G (TOREX)  
MA2Q735 (MATSUSHITA)

CL: 16V, 47 μF (Tantalum type, KYOCERA TAJ)

CIN: 16V, 47 μF (Tantalum type, KYOCERA TAJ)  
16V, 220 μF (Electrolytic Capacitor)

L: <XC9110/9111A, C and E series (Transistor built-in)>  
100 μH (CR54, SUMIDA)  
100 μH (CDRH6D28, SUMIDA)

<XC9110/9111B, D and F series (Transistor external)>  
22 μH, 47 μH (CR54, SUMIDA)

## NOTES ON USE

1. Please do not exceed the value of stated absolute maximum ratings.
2. The DC/DC converter / controller IC's performance is greatly influenced by not only the ICs' characteristics, but also by those of the external components. Care must be taken when selecting the external components.
3. The Lx limit voltage function becomes stable when V<sub>OUT</sub> of the XC9110/9111C series is over 2.0V and the V<sub>DD</sub> of the XC9110/9111E series is over 2.0V.
4. Make sure that the PCB GND traces are as thick as possible, as variations in ground potential caused by high ground currents at the time of switching may result in instability of the IC.
5. Please mount each external component as close to the IC as possible and use thick, short connecting traces to reduce the circuit impedance.

## TEST CIRCUITS

Circuit ①

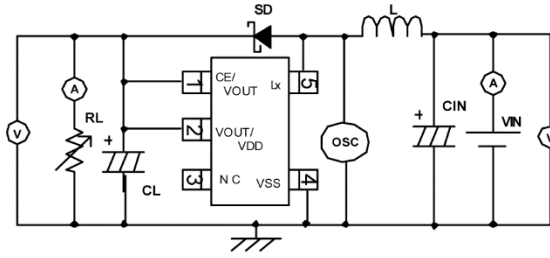

Circuit ⑤



Circuit ②

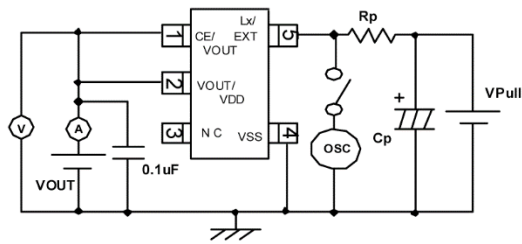

Circuit ⑥

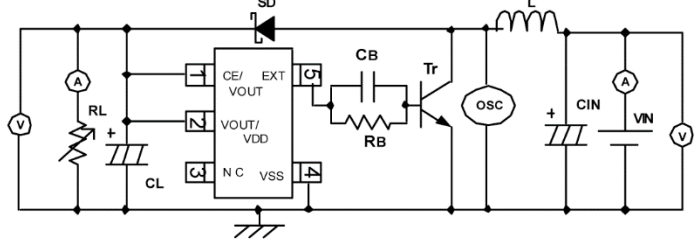

Circuit ③



Circuit ⑦

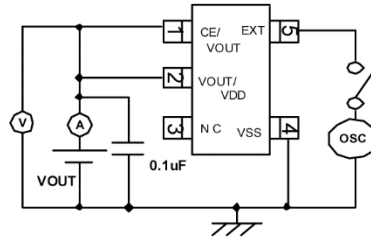

Circuit ④

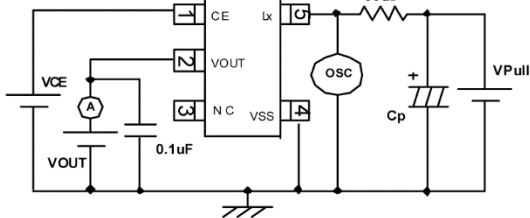

Circuit ⑧



### <External Components>

Circuit ①

CIN: 47  $\mu$  F, 16V (Tantalum)  
 L: CR54, 100  $\mu$  H (SUMIDA)  
 SD: XBS104S14R-G (Schottky, TOREX)  
 CL: 47  $\mu$  F, 16V (Tantalum)

Circuit ④

Cp: 100  $\mu$  F (OS-CON, SANYO)

Circuit ②

Rp: 300  $\Omega$   
 Rp: 10  $\Omega$  (For Lx ON Resistance and measuring Lx Limit Current)  
 Rp: 200  $\Omega$  (For measuring EXT ON Resistance)  
 Cp: 100  $\mu$  F (OS-CON, SANYO)

Circuit ⑥

CIN: 47  $\mu$  F, 16V (Tantalum)  
 L: CR54, 100  $\mu$  H (SUMIDA)  
 Tr: 2SD1628 (SANYO)  
 CB: 2200pF  
 RB: 500  $\Omega$   
 SD: XBS104S14R-G (Schottky, TOREX)  
 CL: 47  $\mu$  F, 16V (Tantalum)

■ TYPICAL PERFORMANCE CHARACTERISTICS

(1) Output Voltage vs. Output Current

\*Topr = 25°C



## TYPICAL PERFORMANCE CHARACTERISTICS (Continued)

(1) Output Voltage vs. Output Current (Continued)

\*Topr = 25°C



**TYPICAL PERFORMANCE CHARACTERISTICS (Continued)**

(2) Efficiency vs. Output Current

\*Topr = 25°C

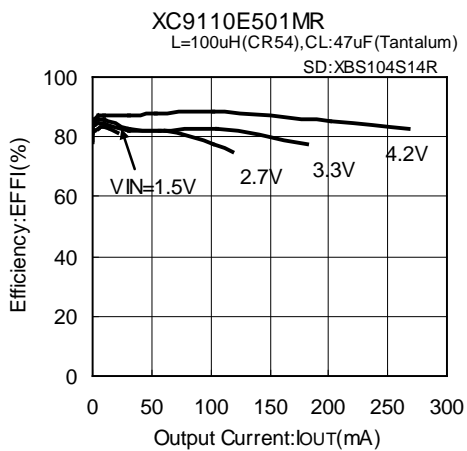
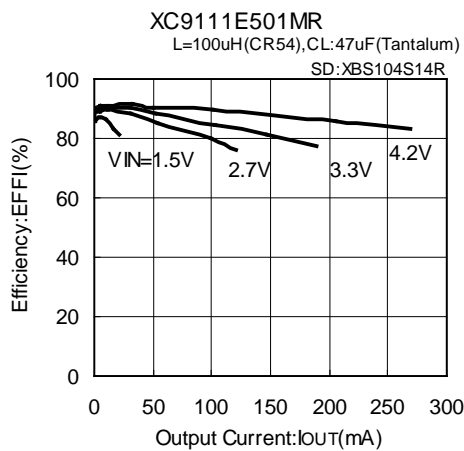

## TYPICAL PERFORMANCE CHARACTERISTICS (Continued)

(2) Efficiency vs. Output Current (Continued)

\*Topr = 25°C

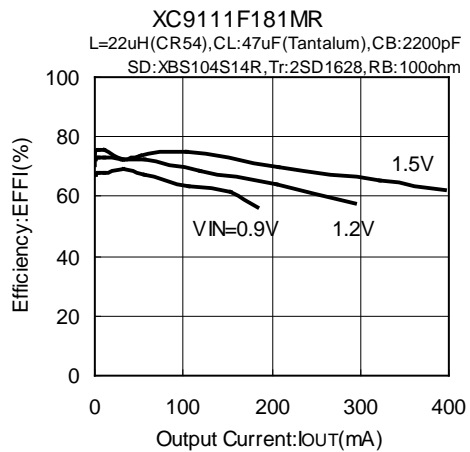
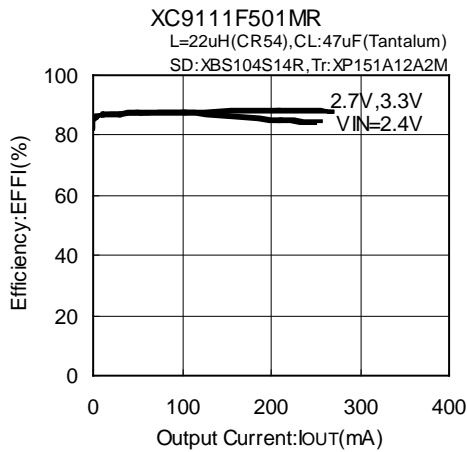
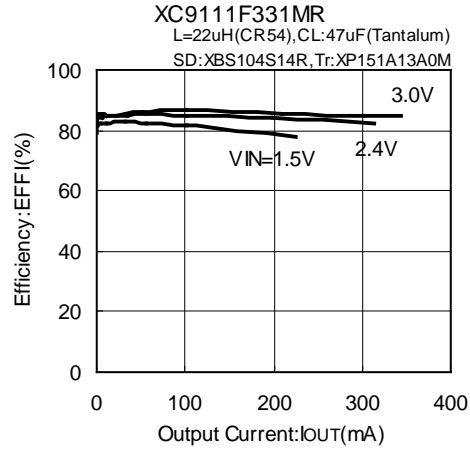
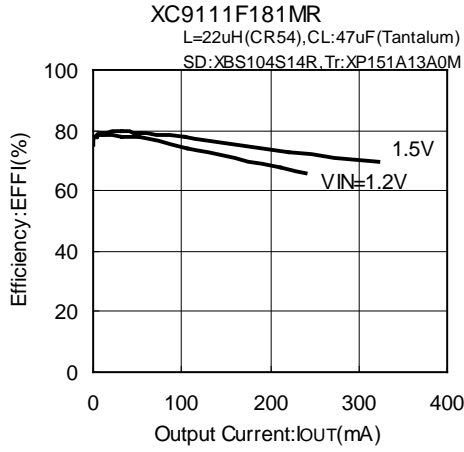

**■ TYPICAL PERFORMANCE CHARACTERISTICS (Continued)**

(3) Ripple Voltage vs. Output Current

\*Topr = 25°C

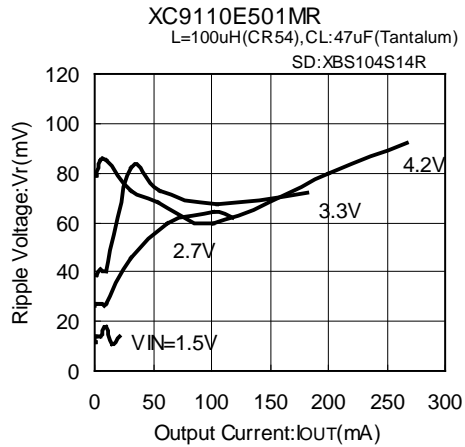
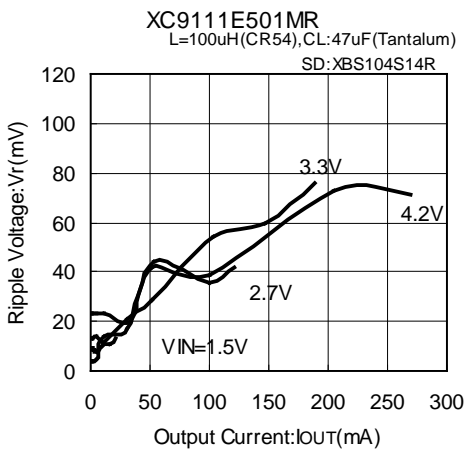
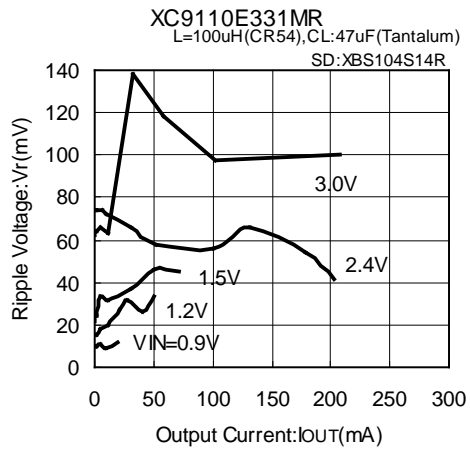
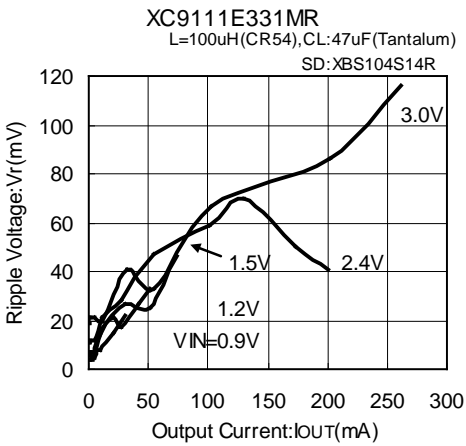
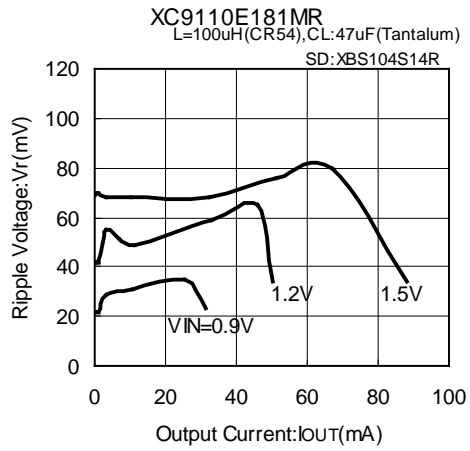
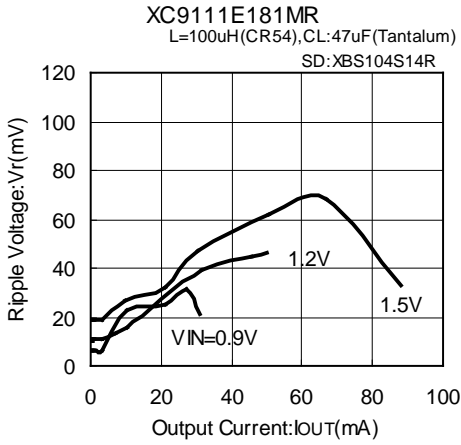

## TYPICAL PERFORMANCE CHARACTERISTICS (Continued)

\*Topr = 25°C

(3) Ripple Voltage vs. Output Current (Continued)

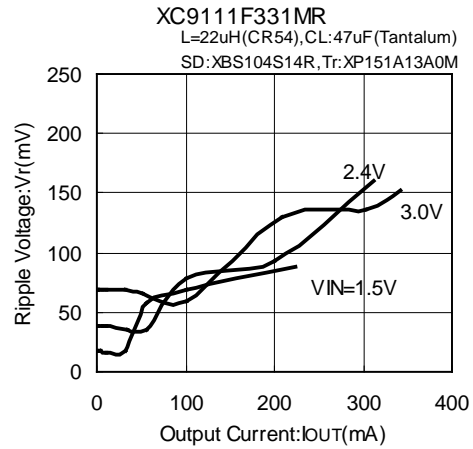



**TYPICAL PERFORMANCE CHARACTERISTICS (Continued)**

(4) Supply Current 1 vs. Output Voltage

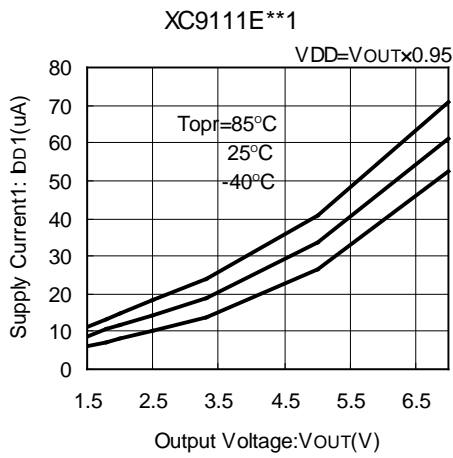

(5) Supply Current 2 vs. Output Voltage

\*Topr = 25°C

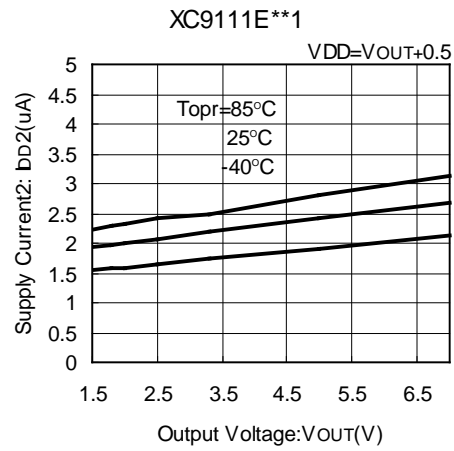

(6) Stand-by Current vs. Output Voltage

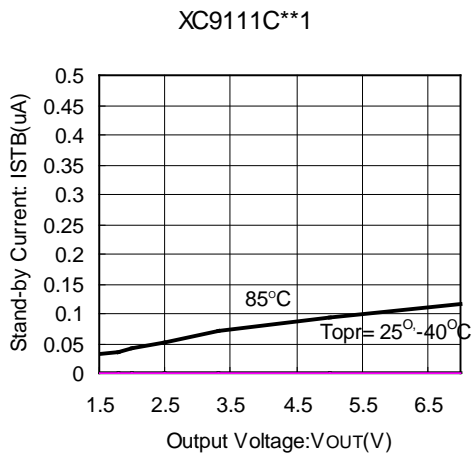

(7) No Load Input Current vs. Output Voltage

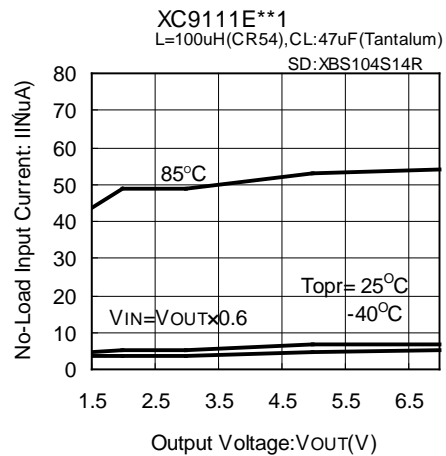

(8) Lx Limit Voltage vs. Output Voltage

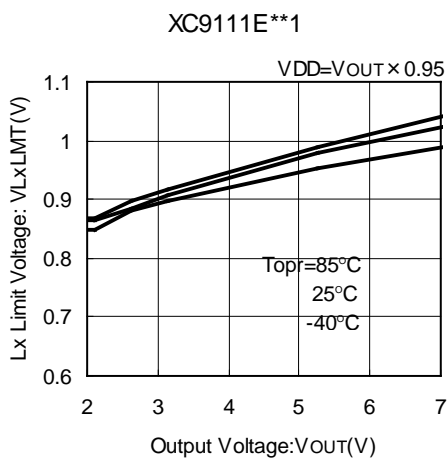

(9) Lx Switch-ON Resistance vs. Output Voltage

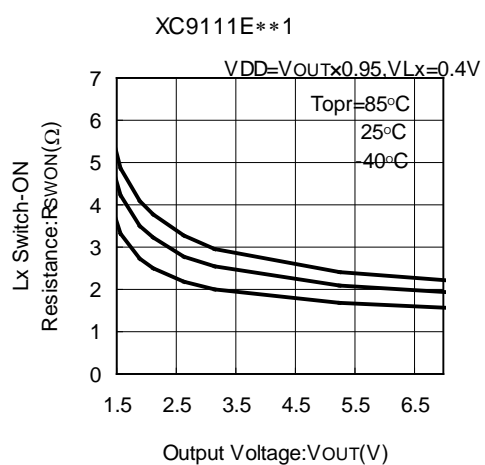

\* The reason for the increase in the "no load input current" figure at Ta=85°C in the performance characteristics is because of an increase in the reverse current of the Schottky diode and not because of abnormalities of the IC itself.

## TYPICAL PERFORMANCE CHARACTERISTICS (Continued) \*Topr = 25°C

(10) EXT H ON Resistance vs. Output Voltage

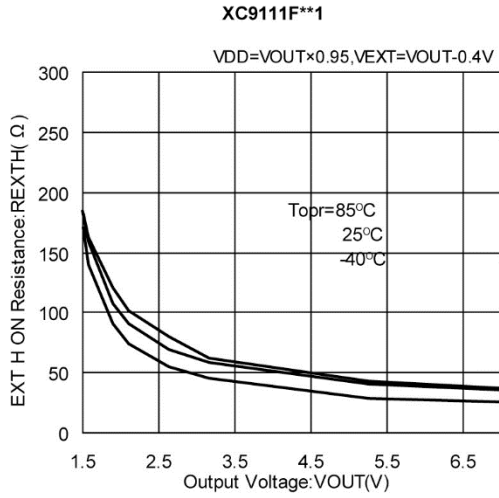

(11) EXT L ON Resistance vs. Output Voltage

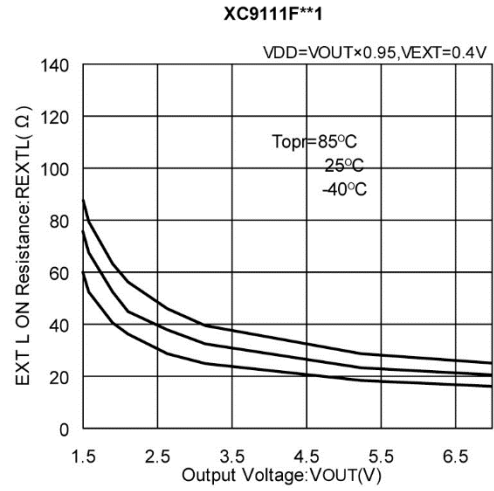

(12) Maximum Oscillation Frequency 1 vs. Output Voltage

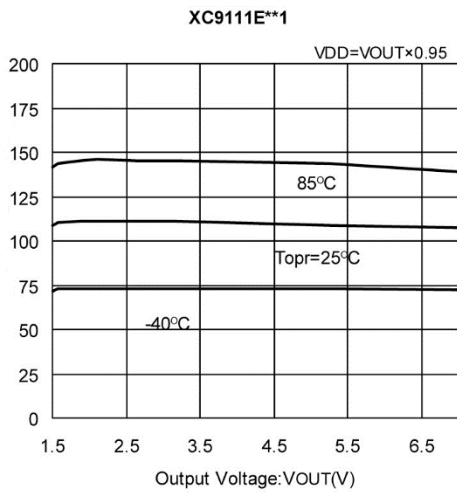

(13) Maximum Oscillation Frequency 2 vs. Output Voltage

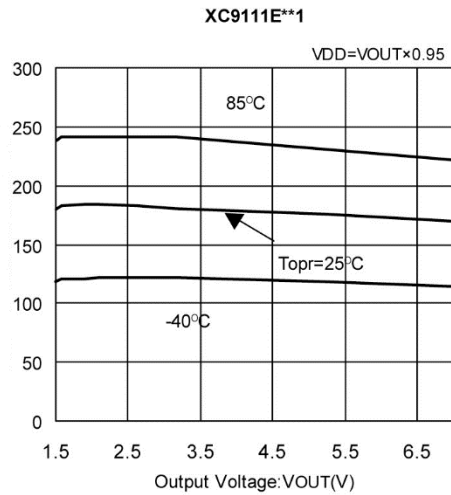

(14) Duty Ratio 1 vs. Output Voltage

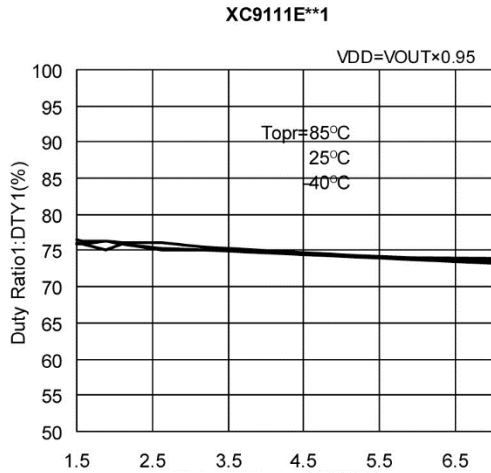

(15) Duty Ratio 2 vs. Output Voltage

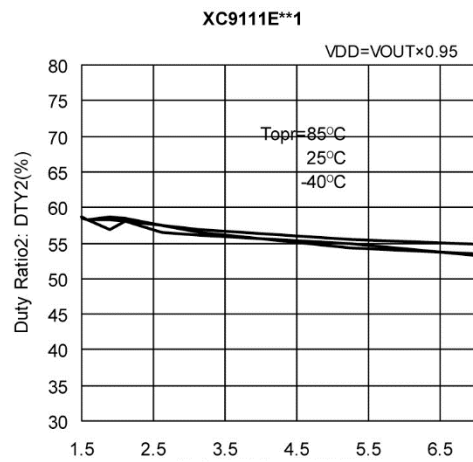

■ TYPICAL PERFORMANCE CHARACTERISTICS (Continued)

\*Topr = 25°C

(16) Output Voltage vs. Ambient Temperature

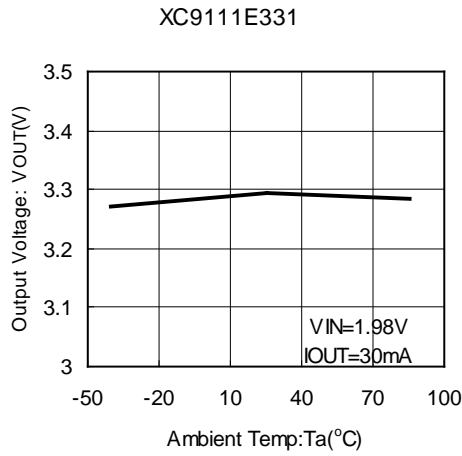

(17) CE "H", "L" Voltage vs. Output Voltage

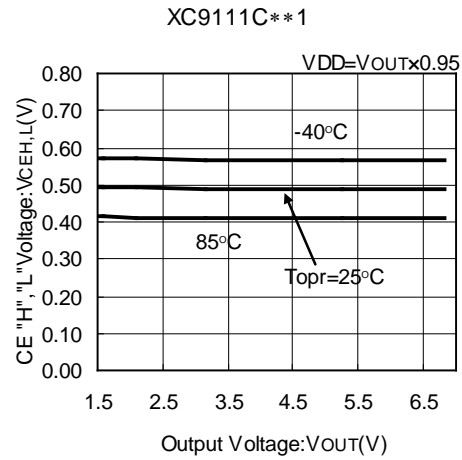

(18) Operation Start Voltage vs. Ambient Temperature

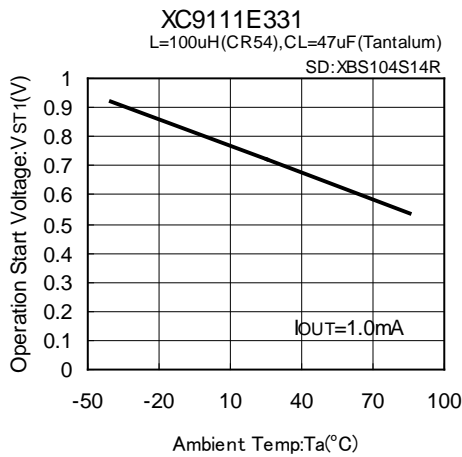

(19) Oscillation Start Voltage vs. Ambient Temperature

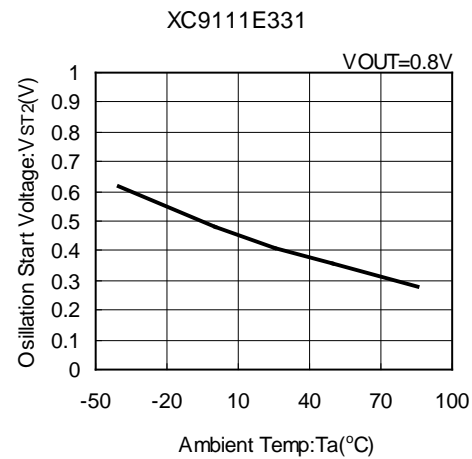

(20) Operation Hold Voltage vs. Ambient Temperature

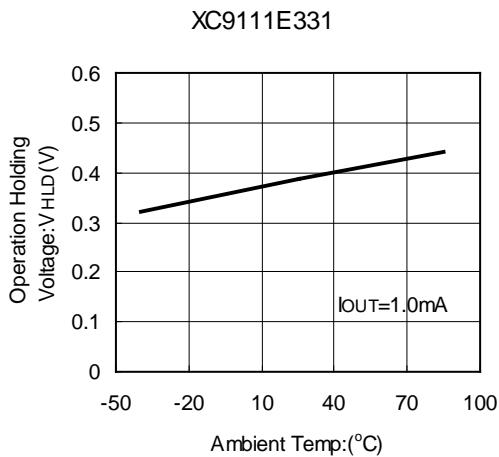

## TYPICAL PERFORMANCE CHARACTERISTICS (Continued)

(21) Load Transient Response

\*Topr = 25°C

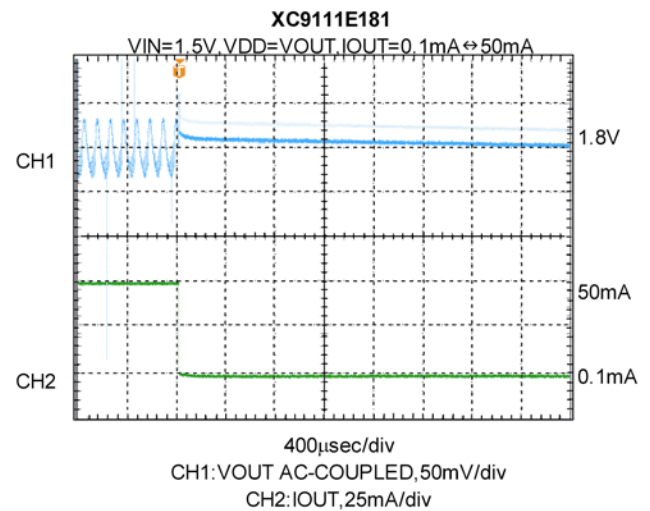
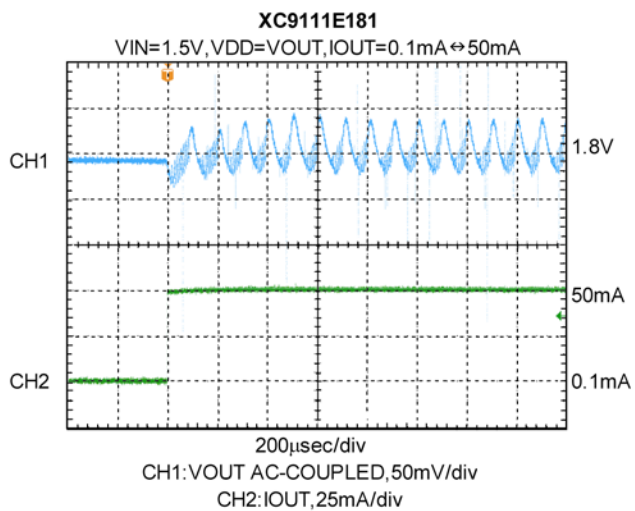
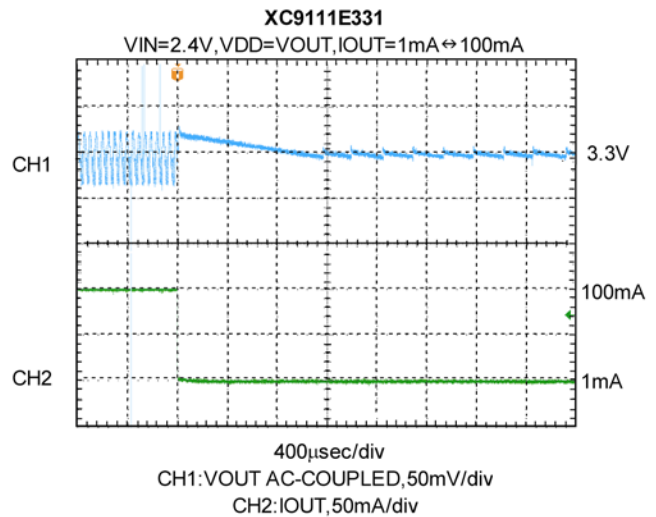
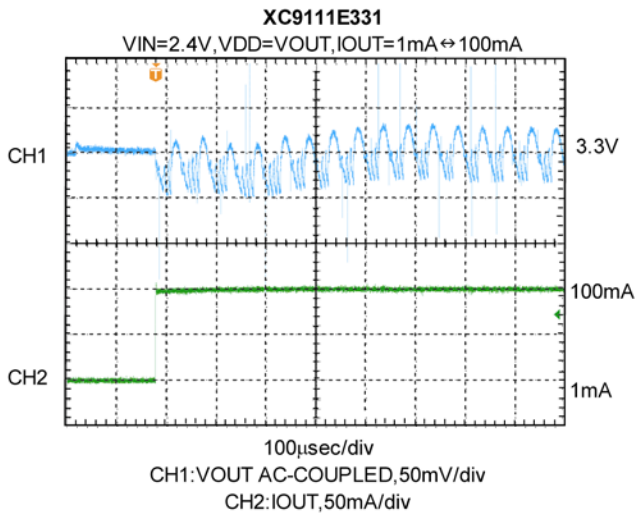
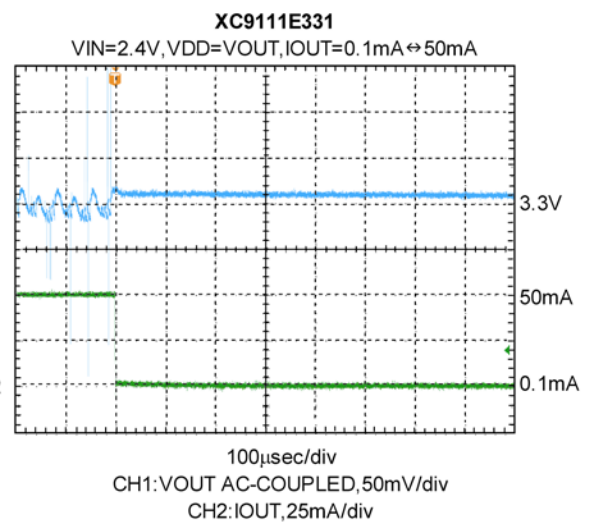
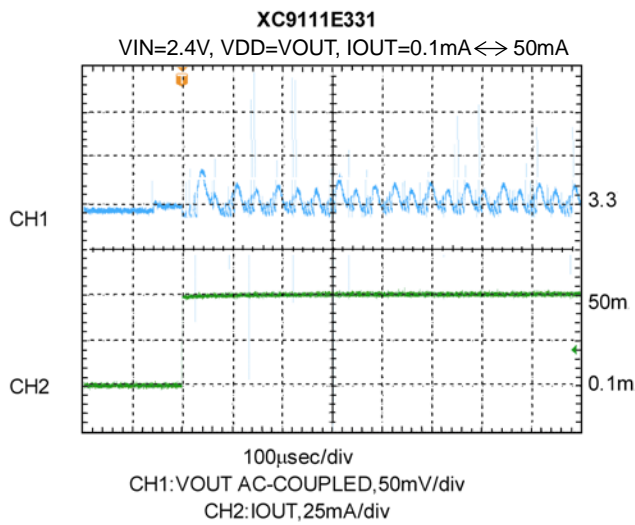

■ TYPICAL PERFORMANCE CHARACTERISTICS (Continued)

(22) Input Transient Response

\*Topr = 25°C

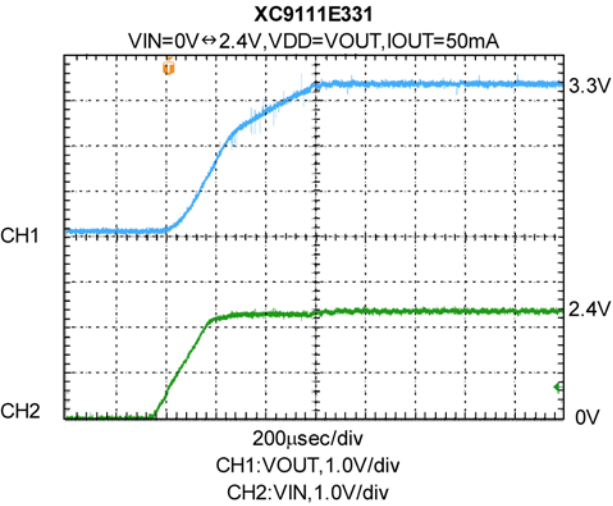
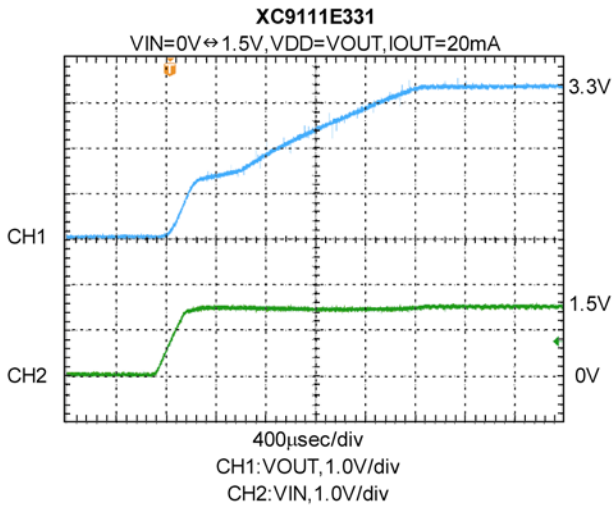
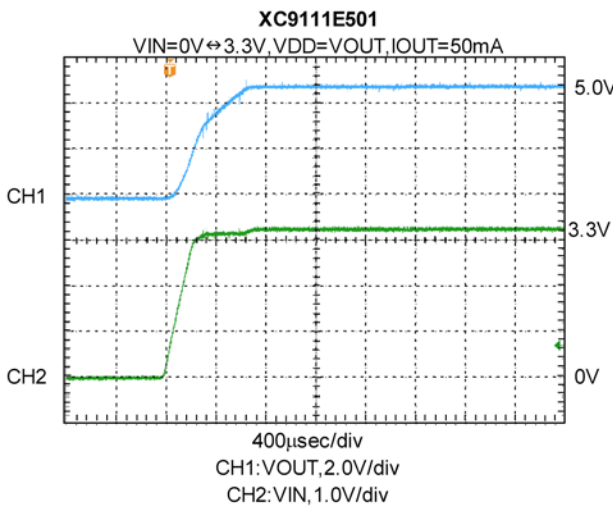
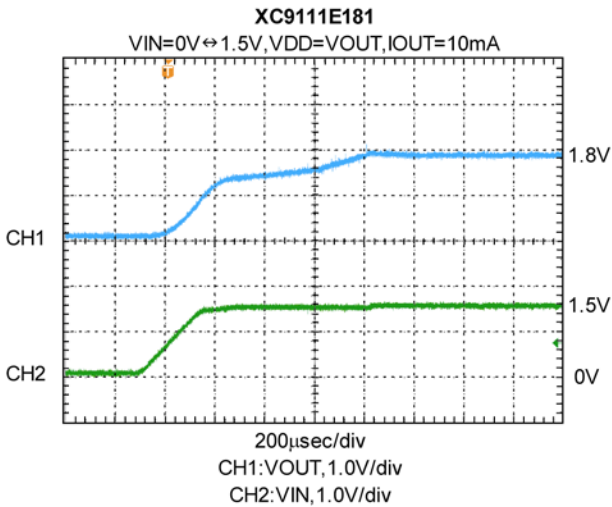

## ■ PACKAGING INFORMATION

For the latest package information go to, [www.torexsemi.com/technical-support/packages](http://www.torexsemi.com/technical-support/packages)

PACKAGE	OUTLINE / LAND PATTERN	THERMAL CHARACTERISTICS	
SOT-23	<a href="#">SOT-23 PKG</a>	Standard Board	<a href="#">SOT-23 Power Dissipation</a>
SOT-25	<a href="#">SOT-25 PKG</a>	Standard Board	<a href="#">SOT-25 Power Dissipation</a>
		JESD51-7 Board	
SOT-89	<a href="#">SOT-89 PKG</a>	Standard Board	<a href="#">SOT-89 Power Dissipation</a>
USP-6C	<a href="#">USP-6C PKG</a>	Standard Board	<a href="#">USP-6C Power Dissipation</a>
		JESD51-7 Board	

## MARKING RULE

### ● SOT-23



SOT-23 (TOP VIEW)

① represents product series

MARK	FUNCTIONS		PRODUCT SERIES
5	-	Built-In Transistor	XC9111Axxxxx
6	-	External Transistor	XC9111Bxxxxx

② represents integer of output voltage and oscillation frequency

OUTPUT VOLTAGE	MARK
	$f_{osc}=100kHz$
1.x	1
2.x	2
3.x	3
4.x	4
5.x	5
6.x	6
7.x	7

③ represents decimal point of output voltage and oscillation frequency

OUTPUT VOLTAGE	MARK
	$f_{osc}=100kHz$
x.0	0
x.1	1
x.2	2
x.3	3
x.4	4
x.5	5
x.6	6
x.7	7
x.8	8
x.9	9

④ represents production lot number

0 to 9, A to Z repeated (G, I, J, O, Q, W excluded)

## MARKING RULE (Continued)

### ● SOT-25

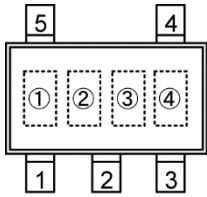

SOT-25 (TOP VIEW)

① represents product series

MARK	FUNCTION		PRODUCT SERIES
<u>V</u>	CE	Tr. Built-in	XC9110Cxxxxx
<u>X</u>	CE	External Tr.	XC9110Dxxxxx
<u>Y</u>	VDD/VOUT	Tr. Built-in	XC9110Exxxxx
<u>Z</u>	VDD/VOUT	External Tr.	XC9110Fxxxxx
<u>5</u>	CE	Tr. Built-in	XC9111Cxxxxx
<u>6</u>	CE	External Tr.	XC9111Dxxxxx
<u>7</u>	VDD/VOUT	Tr. Built-in	XC9111Exxxxx
<u>8</u>	VDD/VOUT	External Tr.	XC9111Fxxxxx

② represents integer of output voltage and oscillation frequency

OUTPUT VOLTAGE	MARK
	$f_{osc}=100kHz$
1.x	1
2.x	2
3.x	3
4.x	4
5.x	5
6.x	6
7.x	7

③ represents decimal point of output voltage and oscillation frequency

OUTPUT VOLTAGE	MARK
	$f_{osc}=100kHz$
x.0	0
x.1	1
x.2	2
x.3	3
x.4	4
x.5	5
x.6	6
x.7	7
x.8	8
x.9	9

④ represents production lot number

0 to 9, A to Z repeated (G, I, J, O, Q, W excluded)



## MARKING RULE (Continued)

● SOT-89

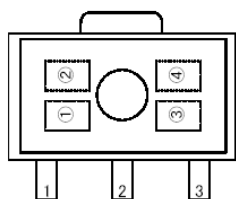

SOT-89 (TOP VIEW)

① represents product series

MARK	FUNCTIONS		PRODUCT SERIES
5	-	Built-In Transistor	XC9111Axxxxx
6	-	External Transistor	XC9111Bxxxxx

② represents integer of output voltage and oscillation frequency

OUTPUT VOLTAGE	MARK
	$f_{osc}=100kHz$
1.x	1
2.x	2
3.x	3
4.x	4
5.x	5
6.x	6
7.x	7

③ represents decimal point of output voltage and oscillation frequency

OUTPUT VOLTAGE	MARK
	$f_{osc}=100kHz$
x.0	0
x.1	1
x.2	2
x.3	3
x.4	4
x.5	5
x.6	6
x.7	7
x.8	8
x.9	9

④ represents production lot number

0 to 9, A to Z repeated (G, I, J, O, Q, W excluded)

## MARKING RULE (Continued)

### ● USP-6C



USP-6C (TOP VIEW)

① represents product series

MARK	PRODUCT SERIES
M	XC9110xxx1Dx
N	XC9111xxx1Dx

② represents series type

MARK	FUNCTION	PRODUCT SERIES
C	CE Tr. Built-in	XC911xCxx1Dx
D	CE External Tr.	XC911xDxx1Dx
E	VDD/VOUT Tr. Built-in	XC911xExx1Dx
F	VDD/VOUT External Tr.	XC911xFxx1Dx

③ represents integer of output voltage

MARK	OUTPUT VOLTAGE
1	1.x
2	2.x
3	3.x
4	4.x
5	5.x
6	6.x
7	7.x

④ represents decimal point of output voltage

MARK	OUTPUT VOLTAGE
0	x.0
1	x.1
2	x.2
3	x.3
4	x.4
5	x.5
6	x.6
7	x.7
8	x.8
9	x.9

⑤ represents oscillation frequency

MARK	OSCILLATION FREQUENCY	PRODUCT SERIES
1	x.0	XC911xxxx1Dx

⑥ represents production lot number

0 to 9, A to Z repeated (G, I, J, O, Q, W excluded)

\* No character inversion used

1. The product and product specifications contained herein are subject to change without notice to improve performance characteristics. Consult us, or our representatives before use, to confirm that the information in this datasheet is up to date.
2. The information in this datasheet is intended to illustrate the operation and characteristics of our products. We neither make warranties or representations with respect to the accuracy or completeness of the information contained in this datasheet nor grant any license to any intellectual property rights of ours or any third party concerning with the information in this datasheet.
3. Applicable export control laws and regulations should be complied and the procedures required by such laws and regulations should also be followed, when the product or any information contained in this datasheet is exported.
4. The product is neither intended nor warranted for use in equipment of systems which require extremely high levels of quality and/or reliability and/or a malfunction or failure which may cause loss of human life, bodily injury, serious property damage including but not limited to devices or equipment used in 1) nuclear facilities, 2) aerospace industry, 3) medical facilities, 4) automobile industry and other transportation industry and 5) safety devices and safety equipment to control combustions and explosions. Do not use the product for the above use unless agreed by us in writing in advance.
5. Although we make continuous efforts to improve the quality and reliability of our products; nevertheless Semiconductors are likely to fail with a certain probability. So in order to prevent personal injury and/or property damage resulting from such failure, customers are required to incorporate adequate safety measures in their designs, such as system fail safes, redundancy and fire prevention features.
6. Our products are not designed to be Radiation-resistant.
7. Please use the product listed in this datasheet within the specified ranges.
8. We assume no responsibility for damage or loss due to abnormal use.
9. All rights reserved. No part of this datasheet may be copied or reproduced unless agreed by Torex Semiconductor Ltd in writing in advance.

TOREX SEMICONDUCTOR LTD.

Компания «Океан Электроники» предлагает заключение долгосрочных отношений при поставках импортных электронных компонентов на взаимовыгодных условиях!

Наши преимущества:

- Поставка оригинальных импортных электронных компонентов напрямую с производств Америки, Европы и Азии, а так же с крупнейших складов мира;
- Широкая линейка поставок активных и пассивных импортных электронных компонентов (более 30 млн. наименований);
- Поставка сложных, дефицитных, либо снятых с производства позиций;
- Оперативные сроки поставки под заказ (от 5 рабочих дней);
- Экспресс доставка в любую точку России;
- Помощь Конструкторского Отдела и консультации квалифицированных инженеров;
- Техническая поддержка проекта, помощь в подборе аналогов, поставка прототипов;
- Поставка электронных компонентов под контролем ВП;
- Система менеджмента качества сертифицирована по Международному стандарту ISO 9001;
- При необходимости вся продукция военного и аэрокосмического назначения проходит испытания и сертификацию в лаборатории (по согласованию с заказчиком);
- Поставка специализированных компонентов военного и аэрокосмического уровня качества (Xilinx, Altera, Analog Devices, Intersil, Interpoint, Microsemi, Actel, Aeroflex, Peregrine, VPT, Syfer, Eurofarad, Texas Instruments, MS Kennedy, Miteq, Cobham, E2V, MA-COM, Hittite, Mini-Circuits, General Dynamics и др.);

Компания «Океан Электроники» является официальным дистрибьютором и эксклюзивным представителем в России одного из крупнейших производителей разъемов военного и аэрокосмического назначения «JONHON», а так же официальным дистрибьютором и эксклюзивным представителем в России производителя высокотехнологичных и надежных решений для передачи СВЧ сигналов «FORSTAR».



## JONHON

«JONHON» (основан в 1970 г.)

Разъемы специального, военного и аэрокосмического назначения:

(Применяются в военной, авиационной, аэрокосмической, морской, железнодорожной, горно- и нефтедобывающей отраслях промышленности)

«FORSTAR» (основан в 1998 г.)

ВЧ соединители, коаксиальные кабели, кабельные сборки и микроволновые компоненты:

(Применяются в телекоммуникациях гражданского и специального назначения, в средствах связи, РЛС, а так же военной, авиационной и аэрокосмической отраслях промышленности).



Телефон: 8 (812) 309-75-97 (многоканальный)

Факс: 8 (812) 320-03-32

Электронная почта: [ocean@oceanchips.ru](mailto:ocean@oceanchips.ru)

Web: <http://oceanchips.ru/>

Адрес: 198099, г. Санкт-Петербург, ул. Калинина, д. 2, корп. 4, лит. А