

■ Embedded Power for  
Business-Critical Continuity™

## *Embedded Power AC-DC and DC-DC Power Conversion Solutions*



  
**EMERSON**  
Network Power™



# Contents

## AC–DC Power Supplies

### Low Power 3-500 W

- Open frame/enclosed 1-4 outputs 10
- Convection/conduction mounting 15
- External power adapters 17

### Healthcare Power Up to 4920 W

- 1-24 outputs 20

### LED Drivers

- LED Lighting Drivers 24

### Micro Medium Power (μMP) Up to 1200 W

- Up to 12 outputs 25

### Medium Power (MP) Up to 1200 W

- 1-10 outputs standard (up to 21 available) 27

### Intelligent Medium Power (iMP) Up to 1500 W

- Up to 21 outputs 29

### Intelligent High Power (iVS) Up to 4920 W

- Up to 24 outputs 32

### Bulk Power 310-12000 W

- Bulk front end 35
- Distributed power bulk front end 41

### Distributed Power (DS) 450-2900 W

- Available 1U, 2U and 3U 44

### DIN Rail (ADN) 24 V 120-960 W

- Single & 3-phase 50

## DC–DC Converters

### Industry Standard Isolated

- Sixteenth-Brick 54
- Eighth-Brick 55
- Quarter-Brick 57
- Half-Brick 59
- RF Power Brick 60

### Industry Standard Non-Isolated

- C-Class 61
- E-Class 63
- F-Class 64
- POLA Products 65
- VRM Processor Power 66

### High Power 300 V Input

- On-board AC–DC Distributed Architecture 67
- Power Factor Correction (PFC) 68

### Low Power Industrial

- Low Power Isolated DC-DC Product 69
- DC-DC Converter for Railway Application 70

- Terms and Conditions 73
- Index 75

For additional information go to  
[www.Emerson.com/EmbeddedPower](http://www.Emerson.com/EmbeddedPower)



The Embedded Power business of Emerson Network Power offers thousands of standard, modified standards and custom power supply products. Every standard product in our extensive portfolio is designed to help speed time-to-market more cost effectively and with less risk – with an outstanding level of support.

Our research, development, sales and support teams throughout the world are dedicated to meeting your needs today and in the future with innovative power solutions. We have invested in state-of-the-art manufacturing facilities and advanced global distribution systems to quickly manufacture and deliver the power products you need. We can quickly respond to your changing demands and have the ability to support you locally or worldwide.

Uniting the well-known Astec and Artesyn brands, the combined strength and experience of these companies, fused with pedigrees of quality, innovation and a deep understanding of our customers' needs, positions Emerson Network Power for continued growth and leadership in the embedded power markets.

This catalog lists key performance data for all standard ac-dc power supplies and dc-dc converters from the Embedded Power business of Emerson Network Power. It is designed to provide you with a fast, easy-to-use means of identifying the ideal power source for your application.

After selecting the product that you need from this catalog, we recommend that you visit our website to obtain more detailed information. You will find that you can quickly download product datasheets and safety certificates, check stock levels at our extensive global distribution network, and request evaluation samples. You can even ask one of our experts for technical advice, or register for the 'MyPower' community portal to gain access to tools, a knowledge base and support to help guide you to the best power solution for your needs.

## Local Support

*Our regional sales offices are ready to provide expert local applications and sales support. In addition, an extensive network of manufacturers' representatives and distributors bring our products to you. Please call for locations of sales offices near you or visit our website at [Emerson.com/EmbeddedPower](http://Emerson.com/EmbeddedPower).*

### Americas (USA)

Telephone: +1 760 930 4600  
Facsimile: +1 760 930 0698

### Europe (UK)

Telephone: +44 (0) 1384 842 211  
Facsimile: +44 (0) 1384 843 355

### Asia (HK)

Telephone: +852 2176 3333  
Facsimile: +852 2176 3888

## Technical Support

### Americas (USA)

+1 888 412 7832 (North America)

### Europe, Middle East and Africa (EMEA)

0 800 0321546 (in the UK)  
+44 800 0321546 (outside the UK)

### Asia

+400 88 99 130 (China)  
+86 29 8883 6505 (outside China)

### Email:

Americas and EMEA  
[techsupport.embeddedpower@emerson.com](mailto:techsupport.embeddedpower@emerson.com)

### Asia

[TSXA.embeddedpower@emerson.com](mailto:TSXA.embeddedpower@emerson.com)

# Embedded Power Selector Guide

## AC-DC

### Modular

### Bulk/Distributed

**uMP Series**  
Up to 1200 W  
Up to 12 Outputs



**LCM Series**  
300 W, 600 W, 1500 W  
85 - 264 Vac  
12 - 60 Vdc



**MP Series**  
Up to 1200 W  
1 - 21 Outputs



**UFE Series**  
1300 - 2000 W  
85 - 264 Vac  
24, 48 Vdc



**iMP Series**  
Up to 1500 W  
1 - 21 Outputs



**DS Series**  
450 - 2900 W  
90 - 264 Vac  
12, 24, 48 Vdc



**iVS Series**  
Up to 4920 W  
1 - 24 Outputs



**HPS Series**  
350 - 3000 W  
90 - 264 Vac  
12, 24, 48 Vdc



## DC-DC

**AC In**

**PFC**  
Full Brick (AIF)  
3/4 Brick (AIT)  
1/4 Brick (AIQ)  
PSE1000PFC

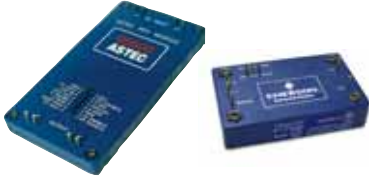

380 Vin

**DC In**

**Isolated**  
1/16 Brick (ALD/AVD)  
1/8 Brick (AEO/ALO/AVO/LES)  
1/4 Brick (AEQ/AGQ/ALQ/AVQ/LQS)  
1/2 Brick (AGH/AVE/BXB/EXB)  
RF (AGF/AVE/RFB)  
Low Power (AEE/AET/ASA)



3.3 - 12 V

## Special

**ADN-C Series**  
120 - 960 W  
Single & 3-phase  
Approved for UL508 &  
Hazardous Locations





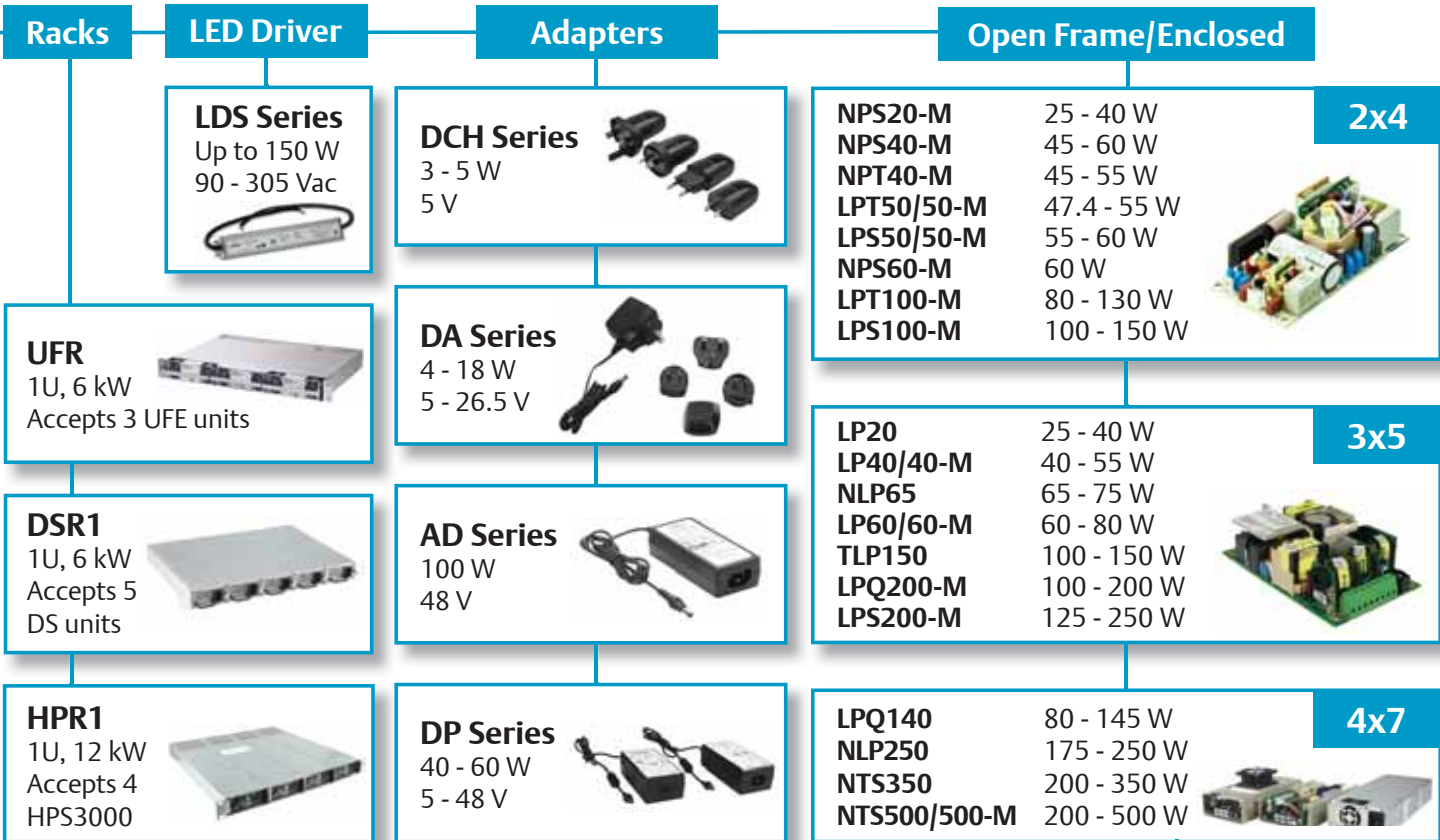

**Fanless/Conduction Cooled**

**LCC250** 150 - 250 W **4x7**



**High Power**  
Full Brick (AIF)  
3/4 Brick (AIT)  
1/2 Brick (AIH)  
1/4 Brick (AIQ)  
PSE 1000 DC-12



**Non-Isolated**  
C-Class (LDO, LGA, SIL, SMT)  
E-Class (APA, APC, SIL, SMT)  
F-Class (SMT)  
POLA (PTH, PTV)

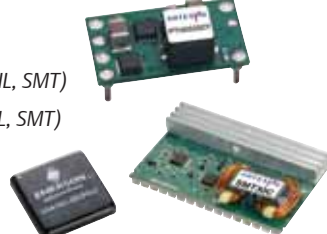

**VRM**  
149 W  
80 - 105 A  
0.8 - 1.9 V



<b>Logic</b>	> 24 V
	24.0 V
	12.0 V
	5.0 V
	3.3 V
	2.5 V
	1.8 V
	1.5 V
	1.2 V
	0.9 V

**Output Current: Up to 100 A**

For more information and a complete overview of Embedded Power products and services go to [www.Emerson.com/EmbeddedPower](http://www.Emerson.com/EmbeddedPower)



For additional information go to  
[www.Emerson.com/EmbeddedPower](http://www.Emerson.com/EmbeddedPower)

## Accelerate, Improve & Enhance the Capabilities of Your Next System Design

*At Emerson Network Power, our engineers have been designing and developing power supply products for over 35 years. Our products have helped pave the way for advancements in numerous applications in the communications, industrial, computing, data storage and healthcare markets.*

When developing products, time is money. Every step in the process that you can eliminate, speed up, or make more effective accelerates your time-to-market and lowers your R&D costs. Major advantages of partnering with Emerson Network Power include:

- Broadest power supply product lines
- Highly versatile power supplies
- Modified standards and value-add services
- Low energy consumption
- Eco-friendly products
- Space-efficient power
- Reliability & quality
- Worldwide distributor network
- Vast knowledge, experience & expertise

### Innovation for the Next Generation

Many of our products incorporate powerful programming, monitoring and self-testing software providing system engineers with critical data to manage power consumption. High efficiency, green design and manufacturing technologies, and innovative demand and supply replenishment systems collectively deliver key business efficiencies and new design capabilities. Emerson Network Power can help take your new product design or redevelopment efforts to the next level with a shorter time-to-profit, higher reliability and greater scalability. Emerson benefits include:

- **Shorter Time-to-Market** – our latest programmable power solutions and our modular, medium/high power  $\mu$ MP and iMP series provide you with shorter time-to-market and offer faster test and qualification than traditional analog power solutions. Our modified standards and value-add services also provide turn-key solutions for the best application match to help accelerate time-to-market without compromising quality.
- **Higher Reliability** – moving from inflexible fixed-output analog power supplies to programmable power solutions enables our engineers to more extensively test and document our products to ensure they meet or exceed your reliability requirements. And we provide a wide range of on-line environmental, EMC compliance and safety certification to help speed your product design process.
- **Greater Scalability** – many of our latest power solutions are scalable, programmable and plug-compatible with our earlier-generation products, enabling you to quickly address changes or enhancements to your systems. You can now satisfy most changes in power requirements simply by reprogramming the power supply – and if your needs change radically, you can easily swap to a more capable solution. This inherent scalability eliminates redesign costs, reduces testing time and provides you with greater design flexibility.



## Power Supply Design Controls

*Emerson utilizes the following design methodologies and techniques to ensure that our power supplies meet the rigorous quality & reliability requirements of the communications, industrial, computing, data storage and healthcare markets.*

### Reliability Models and Predictions

- A prediction of design reliability in terms of Mean Time Between Failures (MTBF) using Telecordia, Bellcore or MIL-HDBK-217F
- Not intended as a measure of expected field performance, but for design trade-off analysis and review of part stress derating performance

### Failure Modes and Effect Analysis

- An analytical technique to identify and review failure modes, their causes, mechanisms and effects
- Provides a formal risk assessment to reduce field failures at the customer site

### Component Selection

- Database warehouse of all component information
- Design engineers can only select components rigorously approved from suppliers that have undergone strict qualification and auditing process

### Derating Analysis

- Intended to reduce the failure rate of components

### Design for Manufacturability

- Design rules regarding manufacturability

### Simulation Analysis – Computer-Aided Engineering Tools

- Thermal Simulation
- Circuit Simulation
- EMI Field Simulation
- Detailed Mechanical Design
- PCB Layout and Tracking
- Structural Simulation

### Emerson Computer-Aided Engineering Tools



Thermal Simulation

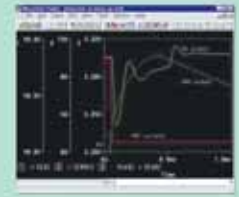

Circuit Simulation

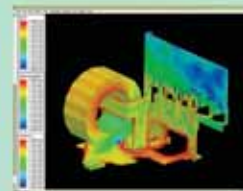

EMI Field Simulation



Detailed Mechanical Design



PCB Layout and Tracking



Structural Simulation



## MyPower Community Portal

**Discover. Communicate. Collaborate.**

MyPower is a free community portal that provides a variety of tools and resources including:

### Community

Utilizing the tools and resources provided will increase your standard knowledge base of our industry. Resources include:

- Industry Links
- What's New
- Trade Shows
- Tools & Calculators



### Knowledge Base

Familiarize yourself with our products and services. This section is designed to help build your industry knowledge.

- Product Videos
- White Papers
- Industry Books
- Educational Product Videos



### Support

Emerson Network Power strives to support your needs. In this section you will find:

- Factory Quality, Safety and Environmental Certifications



To sign up for a free MyPower account go to [www.Emerson.com/MyPower](http://www.Emerson.com/MyPower)



twitter

facebook

YouTube  
Broadcast Yourself™

### Stay Connected.

The latest happenings are being posted on Twitter, Facebook and YouTube! Sign up for one or all of the sites below and stay connected with Emerson Network Power!

[www.twitter.com/EmersonEmPower](http://www.twitter.com/EmersonEmPower)

[www.facebook.com/EmersonPowerSupplies](http://www.facebook.com/EmersonPowerSupplies)

[www.youtube.com/EmersonNetworkPower](http://www.youtube.com/EmersonNetworkPower)





## AC-DC Power Supplies

*Emerson Network Power is widely acknowledged as an industry leader and produces an exceptionally wide range of AC-DC power conversion products.*



# Low Power

Open frame/enclosed 1-4 outputs

20-500 Watts

## Special Features



### All models feature:

- Industry standard footprints
- Wide-range AC input
- Full power to 50 °C
- High demonstrated MTBF
- Overvoltage protection
- Overload protection
- Built-in EMI filtering
- Extensive safety approvals
- Derated operation to 70 °C

### Many models feature:

- EN61000-3-2 compliance
- Supervisory outputs (5 V/12 V)
- Wide-adjust floating 4<sup>th</sup> output
- Single wire current share
- Medical approvals
- Remote sense
- Adjustable outputs
- Power fail
- Wide-adjust on single output models
- Derated operation to 80 °C

Output Power		Output				Size W x L x H (mm)	Model
[Forced Air]	Free Air	V1	V2	V3	V4		
<b>[40 W]</b>	<b>25 W</b>	<b>LP20 Series</b>					
		5V@5A [8A]*				3" x 5" x 1.2"	LPS22
		12V@2.1A [3.3A]*				(76.2 x 127 x 30.5)	LPS23
		15V@1.7A [2.7]*					LPS24
		24V@1.1A [1.8A]*					LPS25
		5V@3A [4A]	12V@1.5A [2A]	-12V@0.5A [0.7A]			LPT22
		5V@4A [5A]	12V@0.5A [0.7A]	-12V@0.5A [0.7A]			LPT23
		5V@3A [4A]	12V@1.5A [2A]	-5V@0.5A [0.7A]			LPT24
		5V@3A [4A]	15V@1.5A [2A]	-15V@0.5A [0.7A]			LPT25
<b>[40 W]</b>	<b>25 W</b>	<b>NPS20-M Series</b>					
		5V@5A [8A]*				2" x 4" x 1"	NPS22-M
		12V@2.1A [3.3A]*				(50.8 x 101.6 x 25.4)	NPS23-M
		15V@1.7A [2.7A]*					NPS24-M
		24V@1A [1.8A]*					NPS25-M
		48V@0.5A [0.84A]*					NPS28-M
<b>[47 W]</b>	<b>Enclosed</b>	<b>LCT43-E</b>					
		5V@4A [7A]	12V@1A [1.2A]	-12V@0.5A [0.5A]		3.2" x 6.2" x 1.5"	LCT43-E
						(81.3 x 157.5 x 38.1)	
<b>[50 W]</b>	<b>40 W</b>	<b>NLP40 Series</b>					
		3.3V@9A*				2.5" x 4.25" x 1.15"	NLP40-76S3J
		12V@4A*				(63.5 x 108 x 29.2)	NLP40-7612J
		5V@9A*					NLP40-7605J
		12V@4A*					NLP40-7612J
		15V@3.3A*					NLP40-7615J
		24V@2A*					NLP40-7624J
		48V@1A*					NLP40-7617J
		5V@4.5A	12V@3A				NLP40-7629J
		12V@2.1A	-12V@2.1A				NLP40-7627J
		3.3V@4.5A	12V@3A	-12V@0.5A			NLP40-76T366J
		5V@4.5A	12V@3A	-12V@0.5A			NLP40-7608J
	5V@4.5A	15V@2A	-15V@0.5A			NLP40-7610J	

Options:  
 [ ] Rating with 30 CFM of air  
 (1) Optional cover/enclosure  
 \* Floating output

Output Power		Output				Size W x L x H (mm)	Model
[Forced Air]	Free Air	V1	V2	V3	V4		
<b>[55 W]</b>	<b>40 W</b>	<b>LP40 Series</b>					
 (1)		3.3V@8A[11A]*				3" x 5" x 1.2"	LPS41
		5V@8A[11A]*				(76.2 x 127 x 30.5)	LPS42
		12V@3.3A[4.5A]*					LPS43
		15V@2.6A[3.6A]*					LPS44
		24V@1.6A[2.3A]*					LPS45
		48V@0.9A[1.2A]*					LPS48
		3.3V@4A[7A]	5V@1.5A[2A]	+12V@0.5A[0.7A]			LPT41
		5V@4A[5A]	12V@2A[2.5A]	-12V@0.5A[0.7A]			LPT42
		5V@6A[8A]	12V@0.5A[0.7A]	-12V@0.5A[0.7A]			LPT43
		5V@4A[5A]	12V@2A[2.5A]	-5V@0.5A[0.7A]			LPT44
		5V@4A[5A]	15V@2A[2.5A]	-15V@0.5A[0.7A]			LPT45
		5V@4A[5A]	24V@1A[1.5A]	+12V@0.5A[0.7A]			LPT46
		5V@4A[5A]	24V@1A[1.5A]	-12V@0.5A[0.7A]			LPT47
	<b>[55 W]</b>	<b>45 W</b>	<b>NPT40-M Series</b>				
 <b>NEW!</b>		5V@5A[8A]	12V@2.5A[3A]	-12V@0.5A[0.7A]			NPT42-M
		5V@5A[8A]	15V@2A[2.4A]	-15V@0.5A[0.7A]			NPT43-M
		5V@5A[8A]	24V@1A[1.5A]	12V@0.5A[0.7A]			NPT44-M
<b>[60 W]</b>	<b>45 W</b>	<b>NPS40-M Series</b>					
 (1)		5V@8A[11A]*				2" x 4" x 1"	NPS42-M
		12V@3.75A[5A]*				(50.8 x 101.6 x 25.4)	NPS43-M
		15V@3A[4A]*					NPS44-M
		24V@1.9A[2.5A]*					NPS45-M
		48V@0.94A[1.25A]*					NPS48-M
<b>[55 W]</b>	<b>55 W</b>	<b>LP50 Series</b>					
 (1)		3.3V@8A	5V@3A	12V@0.5A		2" x 4" x 1.3"	LPT51
		5V@8A	12V@3A	-12V@0.5A		(50.8 x 101.6 x 33)	LPT52
		5V@8A	15V@2.4A	-15V@0.5A			LPT53
		5V@8A	24V@1.5A	12V@0.5A			LPT54
		5V@11A*					LPS52
<b>[60 W]</b>	<b>60 W</b>	5V@11A*					LPS52 (-I)
		12V@5A*					LPS53
		12V@5A*					LPS53 (-I)
		15V@4A*					LPS54
		24V@2.5A*					LPS55
		48V@1.25A*					LPS58
				<b>NPS60-M Series</b>			
 <b>NEW!</b> (1)		5V@11A*				2" x 4" x 1"	NPS62-M
		12V@5A*				(50.8 x 101.6 x 25.6)	NPS63-M
		15V@4A*					NPS64-M
		24V@2.5A*					NPS65-M

Options:

[ ] Rating with 30 CFM of air

(1) Optional cover/enclosure

\* Floating output

(-I) Industrial version -40 °C up to 80 °C (derated)

Output Power		Output				Size W x L x H (mm)	Model		
[Forced Air]	Free Air	V1	V2	V3	V4				
<b>[75 W]</b>	<b>65 W</b>	<b>NLP65 Series</b>							
				5V@12A*				3" x 5" x 1.26"	NLP65-7605J
				5V@12A*				(76.2 x 127 x 32)	NLP65-9605J <sup>(5)(G)</sup>
				12V@6.5A*					NLP65-7612J <sup>(G)</sup>
				12V@6.5A*					NLP65-9612J <sup>(5)(G)</sup>
				24V@3.5A*					NLP65-7624J <sup>(G)</sup>
				24V@3.5A*					NLP65-9624J <sup>(5)(G)</sup>
				5V@8A	12V@3A				NLP65-7629J
				5V@8A	12V@3A				NLP65-9629J <sup>(5)(G)</sup>
				5V@8A	24V@2A	+12V@1.0A			NLP65-3322J
				5V@8A	12V@3A	-12V@0.8A			NLP65-7608J <sup>(G)</sup>
				5V@8A	12V@3A	-12V@0.8A			NLP65-9608J <sup>(5)(E,G)</sup>
				5V@8A	15V@2.5A	-15V@0.8A			NLP65-7610GJ
				5V@8A	15V@2.5A	-15V@0.8A			NLP65-9610J <sup>(5)(G)</sup>
				5V@8A	24V@2A				NLP65-7620J
				5V@8A	24V@2A				NLP65-9620J <sup>(5)(G)</sup>
<b>[80 W]</b>	<b>60 W</b>	<b>LP60 Series</b>							
				3.3V@12A [16A]*				3" x 5" x 1.65"	LPS61
				5V@12A [16A]*				(76.2 x 127 x 41.9)	LPS62
				12V@5A [6.7A]*					LPS63
				15V@4A [5.3A]*					LPS64
				24V@2.5A [3.3A]*					LPS65
				48V@1.3A [1.7A]*					LPS68
				3.3V@5A [8.5A]	5V@2.5A [3A]	+12V@0.5A [1A]			LPT61
				5V@7A [8A]	12V@3A [3.5A]	-12V@0.7A [1A]			LPT62
				5V@7A [8A]	15V@2.8A [3.3A]	-15V@0.7A [1A]			LPT63
				5V@7A [8A]	12V@3A [3.5A]	-5V@0.7A [1A]			LPT64
				5V@7A [8A]	24V@1.5A [2A]	+12V@0.7A [1A]			LPT65
		<b>[110 W]</b>	<b>80 W</b>	<b>NLP110 Series</b>					
				5V@22A*				3" x 6.5" x 1.26"	NLP110-9605J
				12V@9.2A*				(76.2 x 165.1 x 32)	NLP110-9612J
				24V@4.6A*					NLP110-9624J
				48V@2.3A*					NLP110-9617J
				5V@18A	3.3V@20A	12V@1A			NLP110-9693J
				12V@8.5A	5V@18A	-12V@1A			NLP110-9608J <sup>(5)</sup>

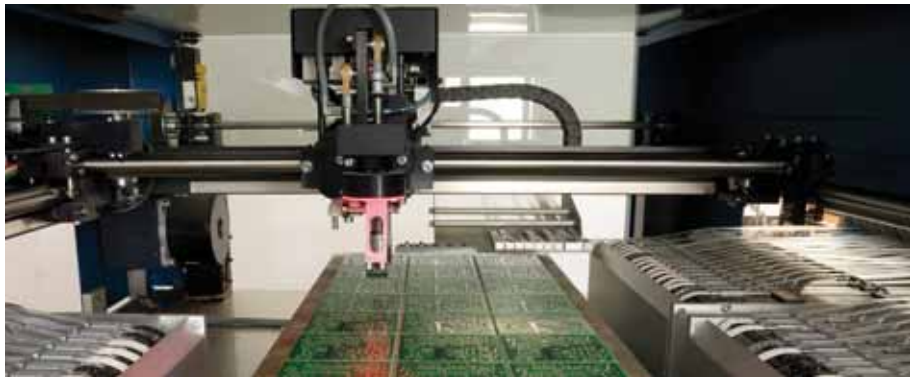
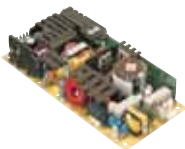
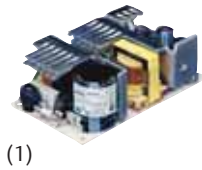
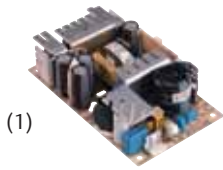

Options:





- (E) To order an enclosed version of the NLP65-9608J, add suffix 'EJ' to the end of the model number, e.g., NLP65-9608EJ. The enclosed version includes: IEC connector, on/off switch, wire harness output connector and fitted cover.
- (G) A safety earth ground pin and ground choke are available as an option. To order, please add the suffix 'GJ' to the end of the model number e.g. NLP65-9612GJ.

- [ ] Rating with 30 CFM of air
- (1) Optional cover/enclosure
- \* Floating output
- (5) These modules feature harmonic current correction to EN6100-3-2

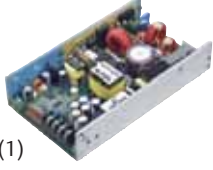

Output Power		Output				Size W x L x H (mm)	Model			
[Forced Air]	Free Air	V1	V2	V3	V4					
[130 W]	80 W	<b>LPT100-M Series</b>								
		3.3 V @ 13 A [18 A]		5 V @ 5 A [9 A]		12 V @ 1 A [2.3 A]		2" x 4" x 1.28"	LPT101-M	
		5 V @ 13 A [18 A]		12 V @ 5 A [9 A]		-12 V @ 1 A [2 A]		(50.8 x 101.6 x 32.7)	LPT102-M	
		5 V @ 13 A [18 A]		15 V @ 4 A [7.2 A]		-15 V @ 1 A [1.5 A]			LPT103-M	
		5 V @ 13 A [18 A]		24 V @ 1.5 A [3 A]		12 V @ 1 A [2.3 A]			LPT104-M	
(1)										
[145 W]	80 W	<b>LP140 Series</b>								
		5 V @ 12 A [25 A] (3.3-5 V)		12 V @ 5 A [6 A]		-12 V @ 1 A [1.5 A] (-12-15 V)		±3.3-25 V @ 1.5 A [4.5 A]*	4" x 7" x 1.5" (101.6 x 177.8 x 38.1)	LPQ142
(1)										
[150 W]	100 W	<b>TLP150 Series</b>								
		12 V @ 12.5 A*						3" x 5" x 1.25"	TLP150R-96S12J <sup>(f)</sup>	
		24 V @ 6.3 A*						(76.2 x 127 x 31.75)	TLP150R-96S24J <sup>(f)</sup>	
		36 V @ 4.2 A*							TLP150R-96S36J	
		48 V @ 3.2 A*							TLP150R-96S48J <sup>(f)</sup>	
(1)										
[150 W]	100 W	<b>LPS100-M Series</b>								
		5 V @ 16 A [24 A]*						2" x 4" x 1.29"	LPS102-M	
		12 V @ 8.3 A [12.5 A]*						(50.8 x 101.6 x 33)	LPS103-M	
		15 V @ 6.7 A [10 A]*							LPS104-M	
		24 V @ 4.2 A [6.3 A]*							LPS105-M	
		48 V @ 2.1 A [3.1 A]*							LPS108-M	
		54 V @ 1.85 A [2.8 A]*							LPS109-M	
(1)										
[175 W]	110 W	<b>LP170 Series</b>								
		5 V @ 22 A [35 A]* (2.5-6 V)						4.25" x 8.5" x 1.5" (108 x 215.9 x 38.1)	LPS172	
		12 V @ 9.1 A [15 A]* (6-12 V)							LPS173	
		15 V @ 7.3 A [12 A]* (12-24 V)							LPS174	
		24 V @ 4.5 A [7.5 A]* (24-54 V)							LPS175	
		5 V @ 15 A [30 A] (3.3-5.5 V)		12 V @ 6 A [8 A]		-12 V @ 0.2 A [3 A] (-12-15 V)		±3.3-25 V @ 2 A [5 A]*	LPQ172	
		5 V @ 10 A [24 A] (3.3-5.5 V)		12 V @ 6 A [8 A]		-12 V @ 1.2 A [3 A] (-12-15 V)		5 V @ 10 A [24 A]* (3.3-5 V)	LPQ173	
		(1)								
[200 W]	100 W	<b>LPQ200-M Series</b>								
		3.3 V @ 13 A [18 A]		5 V @ 13 A [18 A]		12 V @ 5 A [9 A]		-12 V @ 1 A [2 A]	3" x 5" x 1.32"	LPQ201-M
		5 V @ 13 A [18 A]		12 V @ 5 A [9 A]		24 V @ 1.5 A [3 A]		-12 V @ 1 A [2 A]	(76.2 x 127 x 33.6)	LPQ202-M
(1)										

Options:  
 [ ] Rating with 30 CFM of air  
 (1) Optional cover/enclosure  
 \* Floating output

Output Power		Output				Size W x L x H (mm)	Model
[Forced Air]	Free Air	V1	V2	V3	V4		
<b>[250 W]</b>  (1)	<b>125 W</b>	<b>LPS200-M Series</b>					
		5 V @ 20 A [40 A]*				3" x 5" x 1.32"	LPS202-M
		12 V @ 10.3 A [20.8 A]*				(76.2 x 127 x 33.6)	LPS203-M
		15 V @ 8.3 A [16.6 A]*					LPS204-M
		24 V @ 5.2 A [10.4 A]*					LPS205-M
		48 V @ 2.6 A [5.2 A]*					LPS208-M
<b>[250 W]</b>  (1)	<b>175 W</b>	<b>NLP250 Series</b>					
		12 V @ 21 A*				4" x 7" x 1.5"	NLP250R-96S12J
		24 V @ 10.5 A*				(101.6 x 177.8 x 38.1)	NLP250R-96S24J
		48 V @ 5.3 A*					NLP250R-96S48J
		<b>NLP250 – DC (-48 Vdc Input)</b>					
12 V @ 14.6 A [21 A]				4" x 7" x 1.5" (101.6 x 177.8 x 38.1)	NLP250N-48S12J		
<b>[250 W]</b>  (3), (4)		<b>LP250 Series</b>					
		5 V (3-6 V) @ [50 A]*				5" x 9" x 2"	LPS252-C
		12 V (6-12 V) @ [21 A]*				(127 x 228.6 x 50.8)	LPS253-C
		15 V (12-24 V) @ [16.7 A]*					LPS254-C
		24 V (24-48 V) @ [10.4 A]*					LPS255-C
		5 V @ [35 A]	12 V @ [10 A]	-12 V @ [6 A]	±5-25 V @ [6 A]*		LPQ252-C
		5 V @ [35 A]	15 V @ [10 A]	-15 V @ [6 A]	±5-25 V @ [6 A]*		LPQ253-C
<b>[350 W]</b>  (3), (4)		<b>LP350 Series</b>					
		5 V (3-6 V) @ [70 A]*				5" x 9" x 2.5"	LPS352-C
		12 V (6-12 V) @ [29.2 A]*				(127 x 228.6 x 63.5)	LPS353-C
		15 V (12-24 V) @ [23.3 A]*					LPS354-C
		24 V (24-48 V) @ [14.6 A]*					LPS355-C
		5 V @ [50 A]	12 V @ [12 A]	-12 V @ [6 A]	±3.3-24 V @ [6 A]*		LPQ352-C
		5 V @ [50 A]	15 V @ [12 A]	-15 V @ [6 A]	±3.3-24 V @ [6 A]*		LPQ353-C
<b>[350 W]</b>  (3), (4)	<b>200 W</b>	<b>NTS350 Series</b>					
		12 V @ 16.6 A [29.2 A]*				4" x 7" x 1.5"	NTS353
		24 V @ 8.3 A [14.6 A]*				(101.6 x 177.8 x 38)	NTS355
		48 V @ 4.2 A [7.3 A]*					NTS358
		54 V @ 3.7 A [6.5 A]*					NTS359
<b>[500 W]</b>  (3), (4)	<b>200 W</b>	<b>NTS500 Series</b>					
		12 V @ 16.6 A [41.7 A]*				4" x 7" x 1.5"	NTS503
		24 V @ 8.3 A [20.8 A]*				(101.6 x 177.8 x 38)	NTS505
		18 V @ 11.1 A [27.7 A]*					NTS506
		48 V @ 4.2 A [10.4 A]*					NTS508

Options:

[ ] Rating with 30 CFM of air

(1) Optional cover/enclosure

(3) Optional top fan cover (see datasheet for increased dimensions)

(4) Optional end fan cover (see datasheet for increased dimensions)

\* Floating output

# LCC250

Convection/conduction mounting

250 Watts

Total Power: 250 Watts  
 # of Outputs: Single  
 Output: 12 V, 24 V, 48 V



## Special Features

- Wide operating temperature range suited for both outdoor and indoor applications
- 250 W fanless power supply with zero derating up to 85 °C
- IP64 rated
- Conduction or convection mounting
- Differential remote sense
- Output adjust
- Output On/Off (Positive or negative logic user selectable)

## Electrical Specifications

Input	
Input range	90-264 Vac (Operating) 115/230 Vac (Nominal)
Frequency	47-63 Hz
Input fusing	Internal fuse on both L and N lines
Inrush current	50 A
Power factor	>0.92 full load
Harmonics	Meets EN61000-3-2; MIL-STD-461E: CE101; CE102; CS101; CS104
Input current	3.4 A @ 90 Vac full load
Hold up time	16 ms minimum at 115 Vac; 100% load
Efficiency	230 Vac; 100% load 12 V - 89% typical 24 V - 91% typical 48 V - 91.5% typical
Leakage current	<275 µA at 230 Vac

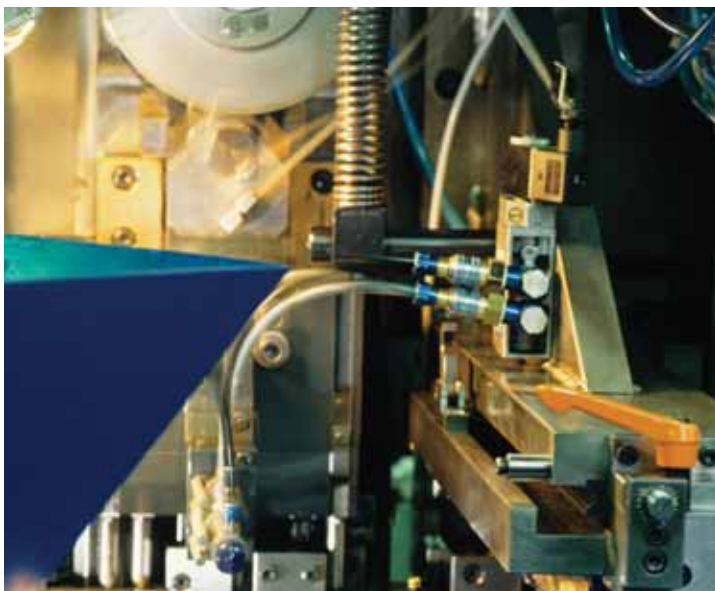

## Environmental Specifications

Operating temperature	Suffix 4P (conduction): -40 °C to +85 °C baseplate temperature Suffix 7P (convection): -40 °C to +85 °C ambient temperature
Storage temperature	-40 °C to 85 °C
Humidity	10% to 100% (condensing & non-condensing)
Altitude	Operating: 13,000 feet Non-operating: 50,000 feet
Shock	IEC 68-2-27
Vibration	IEC 68-2-6 / IEC 721-3-2
Ingress protection	IP64 rated
MTBF (calculated)	>780,000 hours at 100% load; Low line; Telcordia SR332

## Compliance

EMI Class B
EN61000 Immunity

## Safety

UL + CSA	60950-1 ANSI ES60601-1 3rd Ed.
TÜV	60950-1 60601-1 61347-1; 2-13
China	CCC
CB Scheme	IEC 60950-1 IEC 61347-1; 2-13 IEC 60601-1

## Electrical Specifications

Output		
Output rating	12 V @ 20.83 A 24 V @ 10.4 A 48 V @ 5.2 A	—
Set point	±0.2%	Factory set point
Total regulation range	±2%	Line/load/temperature
Rated load	250 W maximum	—
Minimum load	0 A Load	No loss of regulation
Capacitive load	0-330 µF/amp	—
Constant output voltage adjustment range	12 V: +10/-10% 24 V: +14.6/-15% 48 V: +15%/-15%	Adjust via VR2
Constant output current adjustment range	+0/-50%	Adjust via VR1 CC mode supported from Vo nominal down to 80% Vo
Output ripple and noise	1%	See Note 1
Transient response	±5% Vo max transient; recovery <500 µs max	50% load step @ 1 A/µs Step load verified at: 50% to 100% load; 90-264 Vac input; capacitive load from 0 to 330 µF/Amp
Remote sense	Capable of stable offset of ±0.5 Vdc at output cable termination	+SENSE (red wire); -SENSE (black wire)
Output On/Off	Remote on/off referenced to secondary side. Positive or negative logic user selectable via CN2. Factory default is positive logic.	On/off (orange wire); on/off return (white wire)
Overload protection (OCP)	<150% Io	Autorecovery
Overvoltage protection (OVP)	110% to 135% Vo	Latching mode; requires input AC recycle
Overtemp protection (OTP)	—	Autorecovery; hiccup mode
Output isolation	4000 Vac Input to Output 1500 Vac Input to Ground 500 Vac Output to Ground	—

## Ordering Information

Model Number	Output	Adjustment Range	Output Current		Output Ripple P/P <sup>1</sup>	Combined Line/ Load Regulation
			Min	Max		
LCC250-12U-4P	12 V	±10%	0 A	20.8 A	1%	±2%
LCC250-12U-4PE	12 V	±10%	0 A	20.8 A	1%	±2%
LCC250-12U-7P	12 V	±10%	0 A	20.8 A	1%	±2%
LCC250-12U-7PE	12 V	±10%	0 A	20.8 A	1%	±2%
LCC250-24U-4P	24 V	+14.6/-15%	0 A	10.4 A	1%	±2%
LCC250-24U-4PE	24 V	+14.6/-15%	0 A	10.4 A	1%	±2%
LCC250-24U-7P	24 V	+14.6/-15%	0 A	10.4 A	1%	±2%
LCC250-24U-7PE	24 V	+14.6/-15%	0 A	10.4 A	1%	±2%
LCC250-48U-4P	48 V	±15%	0 A	5.2 A	1%	±2%
LCC250-48U-4PE	48 V	±15%	0 A	5.2 A	1%	±2%
LCC250-48U-7P	48 V	±15%	0 A	5.2 A	1%	±2%
LCC250-48U-7PE	48 V	±15%	0 A	5.2 A	1%	±2%

1. Output ripple measured at the end of the output cable terminated with 10 µF tantalum capacitor in parallel with 0.1 µF ceramic capacitor.
2. Additional external capacitance required to meet the indicated Output Ripple Limits. Please check the Technical Reference Notes.
3. China CCC approval applies to part numbers with "-xxE" suffixes only.



# Low Power

## External power adapters

### 3-100 Watts

#### Special Features

**All models feature:**

- Wide-range AC input
- High demonstrated MTBF
- Overload protection
- Extensive safety approvals

**Many models feature:**

- EN61000-3-2 compliance
- Medical approvals
- Thermal protection
- Energy Star/ErP

**AC Input:**

- Wallmount
  - U.S. – 2-prong
  - China – 2-prong
  - Europe – 2-prong
  - United Kingdom – 3-prong
  - Australia – 2-prong
  - Korea – 2-prong
  - Japan – 2-prong
  - Interchangeable
- Freestanding
  - IEC320 2-pin (C14) & (C6)
  - IEC320 2-pin (C8)

**DC Output:**

- Single output
  - 2.5 mm barrel plug
  - 2.1 mm right angle plug



Output Power

#### 3 W



	V1	V2	V3	Size W x L x H (mm)	Model
<b>DCH3 Series – USB</b>					
5 V @ 0.55 A				1.03" x 2.28" x 1.81" (26.1 x 58 x 46)	DCH3-050US-0001 DCH3-050US-0002
5 V @ 0.55 A				1.03" x 2.28" x 1.80" (26.1 x 58 x 45.8)	DCH3-050EU-0005 DCH3-050EU-0006
5 V @ 0.55 A				2.02" x 2.28" x 0.91" (51.2 x 57.8 x 23)	DCH3-050UK-0005 DCH3-050UK-0006
5 V @ 0.55 A				1.07" x 2.66" x 1.81" (27.2 x 67.2 x 46)	DCH3-050US-0004
5 V @ 0.55 A				1.07" x 2.66" x 1.81" (27.2 x 67.2 x 46)	DCH3-050US-0005
5 V @ 0.55 A				2.02" x 2.64" x 0.97" (51.2 x 67 x 24.5)	DCH3-050US-0006

#### 5 W



	V1	V2	V3	Size W x L x H (mm)	Model
<b>DCH5 Series</b>					
5 V @ 1 A				1" x 1.4" x 1.88" (25.5 x 35.5 x 47.9)	DCH5-050US
5 V @ 1 A				1" x 1.4" x 1.88" (25.5 x 35.5 x 47.9)	DCH5-050EU
5 V @ 1 A				1.74" x 1.95" x 2.19" (44.2 x 49.53 x 55.62)	DCH5-050UK
5 V @ 1 A				1" x 1.4" x 1.88" (25.5 x 35.5 x 47.9)	DCH5-050AU

Output Power

12 W



V1	V2	V3	Size W x L x H (mm)	Model
<b>DA12-M Series</b>				
5V@2A			1.10" x 2.36" x 2.14" (28 x 60 x 54.3)	DA12-050AU-M
12V@1A				DA12-120AU-M
5V@2A			1.10" x 2.36" x 2.48" (28 x 60 x 63.1)	DA12-050EU-M
12V@1A				DA12-120EU-M
5V@2A			1.98" x 2.36" x 1.90" (50.2 x 60 x 48.3)	DA12-050UK-M
12V@1A				DA12-120UK-M
5V@2A			1.10" x 2.36" x 1.99" (28 x 60 x 50.6)	DA12-050US-M
12V@1A				DA12-120US-M
5V@2A			1.1" x 2.36" x 2.06" (28 x 60 x 52.3)	DA12-050MP-M <sup>(1)</sup>
5V@2A				DA12-050MP-M2.1 <sup>(2)</sup>
12V@1A			1.10" x 2.36" x 2.14" (28 x 60 x 54.3)	DA12-120MP-M <sup>(1)</sup>
12V@1A				DA12-120MP-M2.1 <sup>(2)</sup>

18 W



<b>DA18-M Series</b>				
12V@1.5A			1.1" x 2.36" x 2.14" (28 x 60 x 54.3)	DA18-120AU-M
15V@1.2A				DA18-150AU-M
12V@1.5A			1.1" x 2.36" x 2.48" (28 x 60 x 63.1)	DA18-120EU-M
15V@1.2A				DA18-150EU-M
12V@1.5A			1.98" x 2.36" x 1.90" (50.2 x 60 x 48.3)	DA18-120UK-M
15V@1.2A				DA18-150UK-M
12V@1.5A			1.1" x 2.36" x 1.99" (28 x 60 x 50.6)	DA18-120US-M
15V@1.2A				DA18-150US-M
12V@1.5A			1.1" x 2.36" x 2.06" (28 x 60 x 52.3)	DA18-120MP-M <sup>(1)</sup>
12V@1.5A				DA18-120MP-M2.1 <sup>(2)</sup>
15V@1.2A				DA18-150MP-M <sup>(1)</sup>
12V@1.2A				DA18-150MP-M2.1 <sup>(2)</sup>



24 W



<b>AD24</b>				
12V@2A			1.89" x 4.13" x 1.3" (48 x 105 x 33)	AD2412N3L

Options:

- (1) Interchangeable AC plug - must be purchased separately.
- (2) 2.1 mm x 5.5 mm barrel plug

Output Power	V1	V2	V3	Size W x L x H (mm)	Model
<b>40 W</b> 	<b>DP40 Series</b>				
	9V@4.4A			2.4" x 4.88" x 1.55"	DP4009N2M
	9V@4.4A			(61 x 124 x 39.5)	DP4009N3M
	12V@3.33A				DP4012N2M
	12V@3.33A				DP4012N3M
	15V@2.67A				DP4015N2M
	15V@2.67A				DP4015N3M
	18V@2.22A				DP4018N2M
	18V@2.22A				DP4018N3M
	24V@1.67A				DP4024N2M
	24V@1.67A				DP4024N3M
	48V@0.84A				DP4048N2M
	48V@0.84A				DP4048N3M
<b>60 W</b> 	<b>DPS50 Series</b>				
	5V@6A			2.39" x 5.24" x 1.62"	DPS52
	12V@5A			(60.7 x 133 x 41.15)	DPS53
	15V@4A				DPS54
	24V@2.5A				DPS55
48V@1.25A				DPS58	
<b>100 W</b> 	<b>AD100</b>				
	48V@2.08A			2.56" x 6.14" x 1.44" (65 x 156 x 37.2)	AD10048P3L-001



# Healthcare AC-DC Power Supplies

Up to 4920 Watts

Emerson Network Power produces a wide range of AC-DC power supplies certified for use in medical equipment requiring lower safety ground leakage and higher isolation. The power supplies listed below are designed for use in non-patient critical applications: bio-life science, medical, dental, imaging and laboratory applications such as immunoassay and in-vitro diagnostics machines, ultrasound and mass analyzers. All these power supplies are high efficiency switch-mode designs, and feature medical safety approval to EN60601-1.







## Special Features

**All models feature:**

- Industry standard footprints
- Wide-range AC input
- Remote sense
- Adjustable outputs
- Power fail
- Full power to 50 °C
- High demonstrated MTBF
- Overvoltage protection
- Overload protection
- Built-in EMI filtering
- Medical approvals
- Extensive safety approvals
- Derated operation to 70 °C







**Many models feature:**

- EN61000-3-2 compliance
- Supervisory outputs (5 V/12 V)
- Wide-adjust floating 4<sup>th</sup> output
- Single wire current share
- Wide-adjust on single output models
- Voltage monitor/data logging
- Real-time parametric adjustment & control

Output Power		Output				Size W x L x H (mm)	Model
[Forced Air]	Free Air	V1	V2	V3	V4		
<b>[40 W]</b>  (1)	<b>25 W</b>	<b>NPS20-M Series</b>					
		5 V @ 5 A [8 A]*				2" x 4" x 1"	NPS22-M
		12 V @ 2.1 A [3.3 A]*				(50.8 x 101.6 x 25.4)	NPS23-M
		15 V @ 1.7 A [2.7 A]*					NPS24-M
		24 V @ 1 A [1.8 A]*					NPS25-M
		48 V @ 0.52 A [0.84 A]*					NPS28-M
<b>[55 W]</b>  (1)	<b>40 W</b>	<b>LP40-M Series</b>					
		5 V @ 8 A [11 A]*				3" x 5" x 1.2"	LPS42-M
		12 V @ 3.3 A [4.5 A]*				(76.2 x 127 x 30.5)	LPS43-M
		15 V @ 2.6 A [3.6 A]*					LPS44-M
		24 V @ 1.6 A [2.3 A]*					LPS45-M
		5 V @ 4 A [5 A]	12 V @ 2 A [2.5 A]	-12 V @ 0.5 A [0.7 A]			LPT42-M
5 V @ 4 A [5 A]	15 V @ 2 A [2.5 A]	-15 V @ 0.5 A [0.7 A]			LPT45-M		
<b>[60 W]</b>  (1)	<b>45 W</b>	<b>NPS40-M Series</b>					
		5 V @ 8 A [11 A]*				2" x 4" x 1"	NPS42-M
		12 V @ 3.75 A [5 A]*				(50.8 x 101.6 x 25.4)	NPS43-M
		15 V @ 3 A [4 A]*					NPS44-M
		24 V @ 1.9 A [2.5 A]*					NPS45-M
48 V @ 0.94 A [1.25 A]*					NPS48-M		
<b>[55 W]</b>  <b>NEW!</b>	<b>45 W</b>	<b>NPT40-M Series</b>					
		5 V @ 5 A [8 A]	12 V @ 2.5 A [3 A]	-12 V @ 0.5 A [0.7 A]			NPT42-M
		5 V @ 5 A [8 A]	15 V @ 2 A [2.4 A]	-15 V @ 0.5 A [0.7 A]			NPT43-M
		5 V @ 5 A [8 A]	24 V @ 1 A [1.5 A]	12 V @ 0.5 A [0.7 A]			NPT44-M
<b>[55 W]</b>  (1)	<b>55 W</b>	<b>LP50-M Series</b>					
		3.3 V @ 8 A	5 V @ 3 A	12 V @ 0.5 A		2" x 4" x 1.3"	LPT51-M
		5 V @ 8 A	12 V @ 3 A	-12 V @ 0.5 A		(50.8 x 101.6 x 33)	LPT52-M
		5 V @ 8 A	15 V @ 2.4 A	-15 V @ 0.5 A			LPT53-M
		5 V @ 8 A	24 V @ 1.5 A	12 V @ 0.5 A			LPT54-M

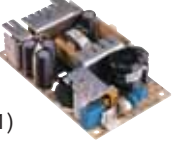
Options:  
 [ ] Rating with 30 CFM of air  
 (1) Optional cover/enclosure  
 \* Floating output

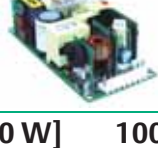

Output Power		Output				Size W x L x H (mm)	Model	
[Forced Air]	Free Air	V1	V2	V3	V4			
<b>[60 W]</b>  (1)	<b>60 W</b>	<b>LPS52-M Series</b>					LPS52-M	
							LPS53-M	
							LPS54-M	
							LPS55-M	
							LPS58-M	
<b>[60 W]</b>  <b>NEW!</b> (1)	<b>60 W</b>	<b>NPS60-M Series</b>					NPS62-M	
						2" x 4" x 1"	NPS63-M	
						(50.8 x 101.6 x 25.6)	NPS64-M	
							NPS65-M	
							NPS65-M	
<b>[75 W]</b>  (1)	<b>65 W</b>	<b>NLP65 Series</b>					NLP65-9912J <sup>(5)</sup>	
						3" x 5" x 1.26"	NLP65-9915J <sup>(5)</sup>	
						(76.2 x 27 x 32)	NLP65-9924J <sup>(5)</sup>	
				5V @ 8A	12V @ 3A			NLP65-9929J <sup>(5)</sup>
				5V @ 8A	24V @ 2A			NLP65-9920J <sup>(5)</sup>
				5V @ 8A	12V @ 3A	-12V @ 1A		NLP65-9908J <sup>(5)</sup>
								NLP65-9908J <sup>(5)</sup>
<b>[80 W]</b>  (1)	<b>60 W</b>	<b>LP60-M Series</b>					LPS63-M	
						3" x 5" x 1.65"	LPS64-M	
						(76.2 x 127 x 41.9)	LPS65-M	
				5V @ 7A [8A]	12V @ 3A [3.5A]	-12V @ 0.7A [1A]		LPT62-M
				5V @ 7A [8A]	15V @ 2.8A [3.3A]	-15V @ 0.7A [1A]		LPT63-M
<b>[110 W]</b>  (1)	<b>80 W</b>	<b>NLP110 Series</b>					NLP110-9905J	
						3" x 6.5" x 1.26"	NLP110-9912J	
						(76.2 x 165.1 x 45.72)	NLP110-9924J	
							NLP110-9917J	
				3.3V @ 20A	2.5V @ 20A	12V @ 1A		NLP110-9994J
				5V @ 18A	3.3V @ 20A	12V @ 1A		NLP110-9993J
				12V @ 8.5A	3.3V @ 20A	-12V @ 1A		NLP110-9995J
				12V @ 8.5A	5V @ 18A	-12V @ 1A		NLP110-9908J
<b>[130 W]</b>  (1)	<b>80 W</b>	<b>LPT100-M Series</b>					LPT101-M	
						2" x 4" x 1.28"	LPT102-M	
						(50.8 x 101.6 x 32.7)	LPT103-M	
				5V @ 13A [18A]	15V @ 4A [7.2A]	-15V @ 1A [1.5A]		LPT104-M
				5V @ 13A [18A]	24V @ 1.5A [3A]	12V @ 1A [2.3A]		LPT104-M
<b>[150 W]</b>  (1)	<b>100 W</b>	<b>LPS100-M Series</b>					LPS102-M	
						2" x 4" x 1.29"	LPS103-M	
						(50.8 x 101.6 x 33)	LPS104-M	
							LPS105-M	
							LPS108-M	
<b>[150 W]</b>  (1)	<b>100 W</b>	<b>TLP150 Series</b>					TLP150N-99S12J <sup>F</sup>	
						3" x 5" x 1.25"	TLP150N-99S24J <sup>F</sup>	
						(177.8 x 101.6 x 31.75)	TLP150N-99S24J <sup>F</sup>	

**Options:**

F Replace the 'J' at the end of the model number with 'FJ' when the optional standby output and/or remote ON/OFF control is required e.g., TLP150N-99S12FJ  
 [ ] Rating with 30 CFM of air

(1) Optional cover/enclosure (see datasheet for increased dimensions)  
 (5) These models feature harmonic current correction to EN61000-3-2  
 \* Floating output

Output Power		Output				Size W x L x H (mm)	Model
[Forced Air]	Free Air	V1	V2	V3	V4		
<b>[175 W]</b>	<b>110 W</b>	<b>LP170-M Series</b>					
		5 V @ 22 A [35 A]* (2.5-6 V)				4.25" x 8.5" x 1.5"	LPS172-M
(1)		12 V @ 9.1 A [15 A]* (6-12 V)				(108 x 215.9 x 38.1)	LPS173-M
		15 V @ 7.3 A [12 A]* (12-24 V)					LPS174-M
		24 V @ 4.5 A [7.5 A]* (24-54 V)					LPS175-M
<b>[200 W]</b>	<b>100 W</b>	<b>LPQ200-M Series</b>					
		3.3 V @ 13 A [18 A]	5 V @ 13 A [18 A]	12 V @ 5 A [9 A]	-12 V @ 1 A [2 A]	3" x 5" x 1.32"	LPQ201-M
(1)		5 V @ 13 A [18 A]	12 V @ 5 A [9 A]	24 V @ 1.5 A [3 A]	-12 V @ 1 A [2 A]	(76.2 x 127 x 33.6)	LPQ202-M
<b>[250 W]</b>	<b>125 W</b>	<b>LPS200-M Series</b>					
		5 V @ 20 A [40 A]*				3" x 5" x 1.32"	LPS202-M
(1)		12 V @ 10.3 A [20.8 A]*				(76.2 x 127 x 33.6)	LPS203-M
		15 V @ 8.3 A [16.6 A]*					LPS204-M
		24 V @ 5.2 A [10.4 A]*					LPS205-M
		48 V @ 2.6 A [5.2 A]*					LPS208-M
<b>[250 W]</b>	<b>175 W</b>	<b>NLP250 Series</b>					
		12 V @ 21 A*				4" x 7" x 1.5"	NLP250N-99S12J
(1)		24 V @ 10.5 A*				(101.6 x 177.8 x 38.1)	NLP250N-99S24J
<b>[250 W]</b>	<b>250 W</b>	<b>LCC250 Series</b>					
		12 V @ 20.8 A				4" x 7" x 1.1"	See LCC250 section
<b>NEW!</b>		24 V @ 10.4 A				(101.6 x 177.8 x 28)	
		48 V @ 5.2 A					
<b>[500 W]</b>	<b>200 W</b>	<b>NTS500-M Series</b>					
		12 V @ 16.6 A [41.7 A]*				4" x 7" x 1.5"	NTS503-M
(4), (5)		24 V @ 8.3 A [20.8 A]*				(101.6 x 177.8 x 38)	NTS505-M
		48 V @ 4.2 A [10.4 A]*					NTS508-M
<b>[300 W]</b>		<b>LCM300 Bulk Front End</b>					
		12-60 V	Single outputs			1.61" x 4.0" x 7.0"	See LCM300 section
<b>NEW!</b>						(4.09 x 101.6 x 177.8)	
<b>[600 W]</b>		<b>LCM600 Bulk Front End</b>					
		3.3-60 V	Single outputs			4.5" x 7.5" x 2.4"	See LCM600 section
<b>NEW!</b>						(114.3 x 190.5 x 62)	
<b>[1500 W]</b>		<b>LCM1500 Bulk Front End</b>					
		12-60 V	Single outputs			2.5" x 5.2" x 10.0"	See LCM1500 section
<b>NEW!</b>						(63.5 x 132.1 x 254)	
<b>Up to 1200 W</b>		<b>µMP Medium Power Series</b>					
		0.9-60 V	1-12 outputs	Fully configurable		3.5" x 10.11" x 1.57"	See µMP section
<b>NEW!</b>						(88.9 x 256.9 x 40)	

Options:

(1) Optional cover/enclosure

(4) Optional top fan covers (see datasheet for increased dimensions)

\* Floating output

(5) Optional end fan cover (see datasheet for increased dimensions)

Output Power [Forced Air]      Free Air	Output				Size W x L x H (mm)	Model
	V1	V2	V3	V4		
<b>Up to 1500 W</b>	<b>Intelligent MP Series</b>					
	2-60 V	1-21 outputs	Fully configurable and intelligent		5" x 10" x 2.5" (127 x 254 x 63.5)	See iMP section

<b>1500-4920 W</b>	<b>Intelligent VS Series</b>					
	2-60 V	1-24 outputs	Fully configurable and intelligent		5" x 11" x 5" (127 x 279.4 x 127)	See iVS section

Output Power	V1	V2	V3	Size W x L x H (mm)	Model
<b>12 W</b>	<b>DA12-M Series</b>				
	5V@2A			1.10" x 2.36" x 2.14" (28 x 60 x 54.3)	DA12-050AU-M
	12V@1A				DA12-120AU-M
	5V@2A			1.10" x 2.36" x 2.48" (28 x 60 x 63.1)	DA12-050EU-M
	12V@1A				DA12-120EU-M
	5V@2A			1.98" x 2.36" x 1.90" (50.2 x 60 x 48.3)	DA12-050UK-M
	12V@1A				DA12-120UK-M
	5V@2A			1.10" x 2.36" x 1.99" (28 x 60 x 50.6)	DA12-050US-M
	12V@1A				DA12-120US-M
	5V@2A			1.1" x 2.36" x 2.06" (28 x 60 x 52.3)	DA12-050MP-M <sup>(1)</sup>
	5V@2A				DA12-050MP-M2.1 <sup>(2)</sup>
	12V@1A			1.10" x 2.36" x 2.14" (28 x 60 x 54.3)	DA12-120MP-M <sup>(1)</sup>
	12V@1A				DA12-120MP-M2.1 <sup>(2)</sup>

<b>18 W</b>	<b>DA18-M Series</b>				
	12V@1.5A			1.1" x 2.36" x 2.14" (28 x 60 x 54.3)	DA18-120AU-M
	15V@1.2A				DA18-150AU-M
	12V@1.5A			1.1" x 2.36" x 2.48" (28 x 60 x 63.1)	DA18-120EU-M
	15V@1.2A				DA18-150EU-M
	12V@1.5A			1.98" x 2.36" x 1.90" (50.2 x 60 x 48.3)	DA18-120UK-M
	15V@1.2A				DA18-150UK-M
	12V@1.5A			1.1" x 2.36" x 1.99" (28 x 60 x 50.6)	DA18-120US-M
	15V@1.2A				DA18-150US-M
	12V@1.5A			1.1" x 2.36" x 2.06" (28 x 60 x 52.3)	DA18-120MP-M <sup>(1)</sup>
	12V@1.5A				DA18-120MP-M2.1 <sup>(2)</sup>
	15V@1.2A				DA18-150MP-M <sup>(1)</sup>
	12V@1.2A				DA18-150MP-M2.1 <sup>(2)</sup>

<b>60 W</b>	<b>DPS50-M Medical</b>				
	5V@6A			2.39" x 5.24" x 1.62"	DPS52-M
	12V@5A			(60.7 x 133 x 41.15)	DPS53-M
	15V@4A				DPS54-M
	24V@2.5A				DPS55-M
	48V@1.25A				DPS58-M

Options:

- (1) Interchangeable AC plug - must be purchased separately.
- (2) 2.1 mm x 5.5 mm barrel plug

# LED Lighting Drivers

Up to 150 Watts



## Special Features

- Constant current and constant voltage operation
- Flexible dimming options
- Free-air rated—no forced air necessary for cooling

## Compliance

- Includes Class 2 outputs
- Includes IP20, IP64 and IP67 water protection
- CISPR 15/FCC Part 15 EMI performance
- Class C harmonics
- >0.9 power factor

## Safety

EN	61347-2-13
UL	8750
CSA	C22.2 No. 107.1
CE	Mark

## Electrical Specifications

Input	
Input range	90-264 Vac (U models); 90-305 Vac (H models)
Input frequency	47-63 Hz
Input fusing	Internally fused
Output	
Constant current	Capable of operating in constant current mode to directly drive LEDs and have optional adjustable current levels*
Constant voltage	Designed to operate in constant voltage mode over a specified range to power external LED drivers*
Control and Protection	
Current limit	Adjustable*
Protection	Short Circuit/Overvoltage/Overtemperature

\* Refer to data sheet for detailed information.

## Ordering Information

Model Number	Input Voltage Range	Rated Output Voltage	Rated Output Current	Dimming Interface	IP Rating
LDS25-36-H03U	90-305 Vac	36 Vdc	700 mA dc	0-10 V	IP20
LDS25-36-H03F	90-305 Vac	36 Vdc	700 mA dc	0-10 V	Open-frame
LDS70-12-U00	90-264 Vac	12 Vdc	5.0 Adc	None	IP67
LDS70-12-H03	90-305 Vac	12 Vdc	5.0 Adc	0-10 V	IP67
LDS70-58-U00	90-264 Vac	58 Vdc	1.2 Adc	None	IP67
LDS70-58-U01	90-264 Vac	58 Vdc	1.2 Adc	2-level & DIP switch	IP64
LDS70-58-H03	90-305 Vac	58 Vdc	1.2 Adc	0-10 V	IP67
LDS70-58-H04	90-305 Vac	58 Vdc	1.2 Adc	Programmable <sup>(1)</sup>	IP67
LDS100-24-U00	90-264 Vac	24 Vdc	4.1 Adc	None	IP67
LDS100-24-U04	90-264 Vac	24 Vdc	4.1 Adc	Programmable <sup>(1)</sup>	IP67
LDS100-24-H00	90-305 Vac	24 Vdc	4.1 Adc	None	IP67
LDS100-24-H03	90-305 Vac	24 Vdc	4.1 Adc	0-10 V	IP67
LDS100-24-H04	90-305 Vac	24 Vdc	4.1 Adc	Programmable <sup>(1)</sup>	IP67
LDS100-31-H03	90-305 Vac	31 Vdc	3.16 Adc	0-10 V	IP67
LDS100-31-H04	90-305 Vac	31 Vdc	3.16 Adc	Programmable <sup>(1)</sup>	IP67
LDS100-48-H03	90-305 Vac	48 Vdc	2.1 Adc	Programmable <sup>(1)</sup>	IP67
LDS150-1400-H03	90-305 Vac	107 Vdc	1400 mAdc	0-10 V	IP67
LDS150-1400-H03C	90-305 Vac	107 Vdc	1400 mAdc	0-10 V	IP67

Notes: 1. The Dimming Interface on these highly-flexible models can be programmed via a Graphical User-Interface. The options include 0-10V, 1-10V and Bi-Level dimming. Maximum and minimum current levels and threshold levels are also programmable.



# MicroMP Series

Cost-efficient, configurable power supply with market-leading density and efficiency

# μMP

## Up to 1200 Watts

Total Power: Up to 1200 Watts  
 Input Voltage: 85-264 Vac  
 120-300 Vdc  
 # of Outputs: Up to 12

**NEW!**



## Special Features

- Optional conformal coating
- Industrial temp range (-40 °C to 70 °C)
- Industrial shock/vibration (>50 G's)
- Low cost
- Low leakage (< 300 μA)
- PMBus
- High efficiency
- Low profile 1U size
- Multi output
- Current limit modification (foldback or constant current)
- High power density
  - μMP4: 10.8 W/cu-in
  - μMP1: 15.1 W/cu-in
- Intelligent fan (speed control/fault status)
- Downloadable GUI from website
- μP controlled PFC input with active inrush protection
- No preload required
- IEC or terminal block input

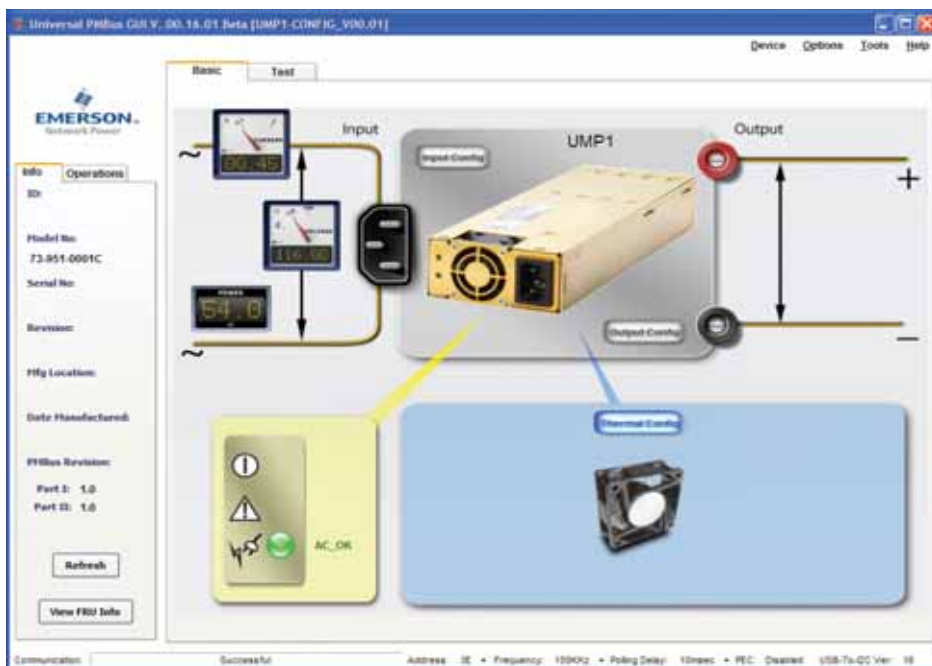

## Electrical Specifications



Input	
Input range	85-264 Vac 120-350 Vdc (limited to 250 Vac/300Vdc in medical apps)
Frequency	47-440 Hz
Inrush current	40 A peak max. (soft start)
Efficiency	Up to 91% @ full case load
Power factor	0.99 typ. meets EN61000-3-2 (n/a @ 440 Hz)
Turn-on time	AC on 2 sec for μMP1 and 1.5 sec for μMP4, inhibit/enable 250 ms typical
EMI filter	CISPR 22/EN55022 Level "B"
Leakage current	300 μA max. @ 240 Vac for μMP1 and 500 μA max. for μMP4; 47-63 Hz
Radiated EMI	CISPR 22/EN55022 Level "B"
Warranty	Two years

## Electrical Specifications

Output	
Factory set point accuracy	±1%
Margining	±3-7% nominal analog (single output module only)
Overall regulation	0.4% or 30 mV which ever is greater
Ripple	RMS: 0.1% or 10 mV, whichever is greater Pk-Pk: 1.0% or 50 mV, whichever is greater Bandwidth limited to 20 MHz
Dynamic response	<±5% or 250 mV, with 50% step load
Recovery time	To within 1% in <300 μs
Reverse voltage protection	100% of rated output current
Thermal protection (OTP)	All outputs disabled when internal temp exceeds safe operating range.
Remote sense	Up to 0.5 V total drop (not available on triple output module)
Single wire parallel	Current share to within 5% of total rated current
DC OK	±5% of nominal
Minimum load	Not required
Housekeeping standby	5 Vdc @ 1.0 A max. present whenever AC input is applied
Module inhibit	Logic - output on with low or open. Different logic options available
Output/Output isolation	>1 Megohm, 500 V

## Environmental Specifications

Operating temperature	-40 °C to 70 °C ambient. Derate each output 2.5% per degree from 50 °C to 70 °C. (-20 °C start up) Meets full spec after 1/2 load. 10 min warm-up
Storage temperature	-40 °C to 85 °C
Electromagnetic susceptibility	Designed to meet EN61000-4; -3, -6, -11 Level 3, Level 4 for -2, -4, -5
Humidity	Operating; non-condensing 10% to 95% RH
Vibration	MIL-STD-810E
MTBF demonstrated	>350,000 hours at full load, one μMP4 case + two modules, Telcordia SR-332 calculated MTBF
Altitude:	Up to 10k feet; derate linear to 50% from 10k-30k feet

## Safety

UL	UL60950/UL60601-1
CSA	CSA22.2 No. 234 Level 5
VDE	EN60950/EN60601-1
BABT	Compliance to EN60950/EN60601 BS7002
CB	Certificate and report
CE	Mark to LVD
CCC	Approved

## Voltage Codes

Standard Output Ratings				
Module Output Voltage Code	Single Output ONE SLOT 240 W Max	Dual Output ONE SLOT 192 W Max		
Module Identification	S2	D = Dual Common Ground I = Dual Isolated Ground		
Output Module Line-Up				
Code	Volts	Output Current V1	Output Current	
			V1	V2
A	2.0	40.0	N/A	
B	2.2	40.0	N/A	
C	3.0	40.0	N/A	
D	3.3	40.0	4.0*	4.0*
E	5.0	36.0	4.0	4.0
F	5.2	34.0	4.0	4.0
G	5.5	32.0	4.0	4.0
H	6.0	30.0	4.0	4.0
I	8.0	25.0	4.0	4.0
J	10.0	24.0	4.0	4.0
K	11.0	22.0	4.0	4.0
L	12.0	20.0	4.0	4.0
M	14.0	17.0	4.0	4.0
N	15.0	16.0	4.0	4.0
O	18.0	13.0	4.0	4.0
P	20.0	12.0	4.0	4.0
Q	24.0	10.0	4.0	4.0
R	28.0	8.6	3.4	3.4
S	30.0	8.0	N/A	
T	33.0	7.0	N/A	
U	36.0	6.7	N/A	
V	42.0	5.7	N/A	
W	48.0	5.0	N/A	
X	54.0	4.4	N/A	
Y	60.0	4.0	N/A	

\* For "I" codes only

Parallel Codes					
Code	Slots in Parallel	Code	Slots in Parallel	Code	Slots in Parallel
1	1&2	6	1&2&3	B	1,2&3; 4&5
2	2&3	7	1,2,3&4	C	1,2,3&4; 5&6
3	3&4	8	1,2,3,4&5	D	1&2; 3&4; 5&6
4	4&5	9	1,2,3,4,5&6	E	1,2&3; 4,5&6
5	5&6	A	1&2; 3&4	0	no module in parallel

## Ordering Information

Case Size	Module/Voltage/Option Codes	Case Option Codes	Software Code	Hardware Code
<b>μMPXY</b>	<b>S2E - DER - DLL</b>	<b>00</b>	<b>A</b>	<b>###</b>
<b>Case Size (mm)</b> Single-Phase Input where X = 4 = 1.57" x 3.5" x 10"; 400 W - 600 W, 4 slots 1 = 1.57" x 5" x 10"; 1000 W - 1200 W, 6 slots  Input Type where Y = T = Terminal Block C = IEC Connector, C14 B = IEC Connector, C16	<b>Module Codes</b> S2 = 200 W Single O/P (1 slot) D = 96 W/96 W Dual O/P Common Ground (1 slot) I = 96 W/96 W Dual O/P Isolated Ground (1 slot)  <b>Voltage Codes:</b> See Voltage Code Table	<b>Case Option Codes</b> First digit 0 - E = Parallel Code  Second digit 0 = No Options 1 = Reverse Air 3 = Global Enable 5 = Opt 1 + Opt 3	Factory assigned for modified standards	Factory assigned for modified standards

## MP Series

Modular power supply for optimum flexibility

Up to 1200 Watts

Total Power: Up to 1200 Watts  
 Input Voltage: 85-264 Vac  
 120-350 Vdc  
 # of Outputs: Up to 21



## Special Features

- Low cost
- Current share on all outputs with ratings of 10 A or greater
- Remote sense on all outputs with ratings greater than 2 A
- Overload protection on all outputs
- Voltage adjustment on all outputs
- Margining on all single output modules
- Input OK signal and status indicator LED
- Global DC OK signal and status indicator LED
- Global and individual module inhibits/enable
- Forced air cooling or customer provided air option
- Isolated 1 A 5 V bias voltage
- Power factor correction
- EN61000-3-2 harmonic distortion compliance
- CISPR 22, EN55022 Curve B conducted/radiated EMI
- European CE Mark requirements
- Optional VME timing and system DC OK module
- Low leakage option
- EN61000 immunity standards
- Standard modification flexibility (see datasheet on [Emerson.com/EmbeddedPower](http://Emerson.com/EmbeddedPower))

## Special Purpose Modules

- Battery charger module
- Extended hold-up module
- High voltage module (non-isolated)
- OR-ing diode module



## Electrical Specifications

Input	
Input voltage	85-264 Vac 120-350 Vdc
Frequency	47-440 Hz
Inrush current	40 A peak maximum (soft start)
Efficiency	70-80% typ. @ full case load
Power factor	0.99 typ. meets EN61000-3-2 (N/A @ 440 Hz)
Turn-on time	AC on 1.5 second typical Inhibit/enable 150 ms typical
EMI filter standard	CISPR 22 EN55022 Level "B"
EMI filter (low leakage option)	CISPR 22 EN55022 Level "A"
Leakage current standard	2.0 mA maximum @ 240 Vac
Leakage current (low leakage option)	300 $\mu$ A maximum @ 240 Vac
Radiated EMI	CISPR 22 EN55022 Level "B"
Holdover storage	20 ms minimum (independent of input Vac)
AC OK	>5 ms early warning minimum before outputs lose regulation Full cycle ride thru (50 Hz)
Harmonic distortion	Meets EN61000-3-2
Isolation	Meets EN60950
Global inhibit/enable	TTL, Logic "1" and Logic "0"; configurable
Input fuse (internal)	MP4: 10 A; MP6: 15 A; MP8: 20 A; MP1: 20 A
Warranty	Two years

Output	
Adjustment range	±10% minimum all outputs
Margining	±4-6% nominal <sup>1</sup>
Overall regulation	0.4% or 20 mV maximum (36 W modules 4% maximum)
Ripple	RMS: 0.1% or 10 mV, whichever is greater; Pk-Pk: 1.0% or 50 mV, whichever is greater; bandwidth limited to 20 MHz
Dynamic response	<2% or 100 mV, with 25% load step
Recovery time	To within 1% in <300 μs second
Overcurrent protection	Single, main of dual output module 105-120% of rated output current
Short-circuit protection	Protected for continuous short-circuit Recovery is automatic upon removal of short
Overvoltage protection (measured at sense connection)	Single output modules
Reverse voltage protection	100% of rated output current
Thermal protection	All outputs disabled when internal temp exceeds safe operating range. > 5 ms warning (AC OK signal) before shutdown
Remote sense	Up to 0.5 V total drop (not available on triple output module)
Single wire parallel	Current share to within 2% of total rated current <sup>2</sup>
DC OK	-2% to -8% of nominal for any monitored output <sup>2</sup>
Minimum load	Not required on single or triple output modules. 10% required on main of dual output modules <sup>3</sup>
Housekeeping standby	5 Vdc @1.0 A maximum present whenever AC input is applied (optional 2.0 A available)
Module inhibit	TTL, isolated, singles and dual (both outputs) only
Switching frequency	250 kHz
Output/output isolation	>1 Megohm
VME signal option board	POR signal & quad external DC OK

## Environmental Specifications

Operating temperature	-20 °C to 50 °C (start @ 0 °C) (derate each output linearly to 50% at 70 °C) (-20 °C to 40 °C max. with rear air option)
Shock/Vibration	MIL-HDBK 810E
Humidity	95% non-condensing
Storage temperature	-40 °C to 85 °C
Temperature coefficient	0.02% per °C
Cooling:	Internal DC fan or customer provided air (option)

## Safety

UL	UL1950
CSA	CSA22.2 No. 234 Level 5
IEC	IEC950, Class 1
VDE	EN60950-1
BABT	Compliance to EN 60950, BS 7002
CB	Certificate and report
CE	Mark

### Notes:

1. Single output modules only
2. Single and main of dual output modules only
3. Contact factory for optional preload if required

## Ordering Information

Sample below is 1200 W case with 12 V @ 50 A; 5 V @ 60 A; 24 V @ 8.5 A; 12 V @ 10 A; 12 V @ 4 A; extended hold-up with no options.

Case Size	Module/Voltage(s) First - Module Code Second - Voltage Code	Add-on Modules Requires 1 slot each	Case Option Codes	Hardware Code
<b>MP1</b>	<b>3L - 2E - 1Q - 4LL</b>	<b>HUP</b>	<b>00</b>	<b>###</b>
<b>Case Size (mm)</b> 4 = 2.5" x 5" x 10"; 400-600 W, 5 Slots (63.5 x 127 x 254) 6 = 2.5" x 5" x 11"; 600-800 W, 5 Slots (63.5 x 127 x 279.4) 8 = 2.5" x 7" x 10"; 800-1000 W, 6 Slots (63.5 x 177.8 x 254) 1 = 2.5" x 8" x 11"; 1000-1200 W, 7 Slots (63.5 x 203.2 x 279.4)	<b>Module Codes</b> Module/Voltage/Option Codes Module Codes: (None) = 36 W Triple O/P (1 slot) 1 = 210 W Single O/P (1 slot) 2 = 360 W Single O/P (2 slot) 3 = 750 W Single O/P (3 slot) 4 = 144 W Dual O/P (1 slot) 5 - 9 = Future  <b>Voltage Codes:</b> See Output Module Voltage/ Current table	<b>Add-on Modules</b> HUP = Hold up module VME = VME POR signal and isolated DC	<b>Case Option Codes</b>  <b>First Digit</b> 0 - 9 = parallel code (See MP parallel codes table on following page)  <b>Second Digit</b> Standard Options <b>0</b> = no options <b>1</b> = rear air exhaust <b>3</b> = global enable <b>5</b> = option package (options 1 & 3) <b>M</b> = low leakage <b>N</b> = low leakage plus option 1 <b>P</b> = low leakage plus option 3 <b>R</b> = low leakage plus option 5	Factory assigned for modifications



# Intelligent MP Series

Intelligent modular power supply for optimum flexibility

Up to 1500 Watts

Total Power: Up to 1500 Watts  
 Input Voltage: 85-264 Vac  
 120-300 Vdc  
 # of Outputs: Up to 21

iMP™



## Special Features

- Medical EN60601-1 approval
- Intelligent I<sup>2</sup>C control
- Voltage adjustment on all outputs (Manual or I<sup>2</sup>C)
- Configurable input and output (case and module) OK signals and indicators
- Configurable inhibit/enable
- Configurable output UP/DOWN sequencing
- Configurable current limit (foldback or constant current)
- High power density (8.8 W/cu-in)
- Intelligent fan (speed control/fault status)
- Downloadable GUI from website
- Customer provided air option
- µP controlled PFC input with active inrush protection
- I<sup>2</sup>C monitor of voltage, current and temp
- Programmable voltage, current limit, inhibit/enable through I<sup>2</sup>C
- Optional extended hold-up module (SEMI F47 compliance)
- CAN BUS and RS-485 interface option
- Low leakage (<300 µA)
- Increased power density to 50% over standard MP
- Backward compatibility with standard MP
- External switching frequency sync input
- Optional conformal coating
- Industrial temp range (-40 °C to 70 °C)
- No preload required
- Industrial shock/vibration (>50 G's)



The iMP software is designed to make the iMP Power Supply Unit (PSU) accessible to the user. It is intended to provide information gathered from the PSU and interactive controls to the basic capabilities of iMP power supply. To download go to: [www.PowerConversion.com/impsoftware](http://www.PowerConversion.com/impsoftware)

## Electrical Specifications

Input	
Input range	85-264 Vac 120-350 Vdc (limited to 300 Vdc in medical applications)
Frequency	47-440 Hz
Inrush current	40 A peak max. (soft start)
Efficiency	Up to 85% @ full case load
Power factor	0.99 typ. meets EN61000-3-2 (n/a @ 440 Hz)
Turn-on time	AC on 2 sec typ., inhibit/enable 150 ms typical Programmable delay; 50 ms internal turn-on delay (Dual Output only)
EMI filter	CISPR 22/EN55022 Level "B"
Leakage current	300 µA max. @ 240 Vac; 47-63 Hz
Radiated EMI	CISPR 22/EN55022 Level "B"
Holdover storage	20 ms minimum (independent of input Vac) additional 34 ms holdover storage with optional HUP module (SEMI F47 compatible)
AC OK	>5 ms early warning min. before outputs lose regulation Full cycle ride thru (50 Hz) (N/A on iMP4 > 750 W @ 90 Vac)
Harmonic distortion	Meets EN61000-3-2
Isolation	Meets EN60950 and EN60601
Global Inhibit/Enable	TTL, Logic "1" and Logic "0"; configurable
Input fuse (internal)	iMP4: 16 A; iMP8: 20 A; iMP1: 25 A (both lines fused)
Warranty	Two years

Output	
Adjustment range*	±10% minimum all outputs (manual) (full module adjustment range using I <sup>2</sup> C)
Margining	±4-6% nominal analog (single output module only)
Overall regulation	0.4% or 20 mV max. (1500 W modules 1% max. 36 W modules 4% max.)
Ripple	RMS: 0.1% or 10 mV, whichever is greater Pk-Pk: 1.0% or 50 mV, whichever is greater Bandwidth limited to 20 MHz
Dynamic response	<2% or 100 mV, with 25% load step
Recovery time	To within 1% in <300 µs
Overcurrent protection**	Configurable through I <sup>2</sup> C (calibration required). Single output module and main output of the dual output module 105-120% of rated output current. Aux output of dual output module 105-140% of rated output current
Short-circuit protection	Protected for continuous short-circuit Recovery is automatic upon removal of short
Overvoltage protection*	Configurable through I <sup>2</sup> C - Single output module 2-5.5 V 122-134%; 6-60 V 110-120% - Dual output module 2-6 V 122-134%; 8-28 V 110-120% - Triple output module
Reverse voltage protection	100% of rated output current
Thermal protection* (OTP and OTW)	Configurable through I <sup>2</sup> C All outputs disabled when internal temp exceeds safe operating range. > 5 ms warning (AC OK signal) before shutdown
Remote sense	Up to 0.5 V total drop (not available on triple output module)
Single wire parallel	Current share to within 2% of total rated current
DC OK*	±5% of nominal. Configurable through I <sup>2</sup> C
Minimum load	Not required
Housekeeping standby	5 Vdc @ 1.0 A max. present whenever AC input is applied (Optional 2.0 A available)
Module inhibit*	Configured and controlled through I <sup>2</sup> C
Switching frequency	250 kHz accepts external sync signal
Output/Output isolation	>1 Megohm, 500 V

\* Can be controlled via I<sup>2</sup>C  
\*\* Controlled via I<sup>2</sup>C but requires load calibration

## Environmental Specifications

Operating temperature	-40 °C to 70 °C ambient. Derate each output 2.5% per degree from 50 °C to 70 °C. (-20 °C start up)
Storage temperature	-40 °C to 85 °C
Electromagnetic susceptibility	Designed to meet EN61000-4; -2, -3, -4, -5, -6, -8, -11 Level 3
Humidity	Operating; non-condensing 10% to 95% RH
Vibration	IEC68-2-6 to the levels of IEC721-3-2
MTBF demonstrated	>550,000 hours at full load, 220 Vac and 25 °C ambient conditions

## Safety

UL	UL60950/UL2601
CSA	CSA22.2 No. 234 Level 5
VDE	EN60950/EN60601-1
BABT	Compliance to EN60950/ EN60601 BS7002
CB	Certificate and report
CE	Mark to LVD

## Output Module Line-up

Module Code	1	2	3	4	5
Module Type	Single	Single	Single	Dual	Triple
Max output power	210 W	360 W	750 W	144 W	36 W
Max output current	35 A	60 A	150 A	10 A	2 A
Output voltages available*	2-60 V	2-60 V	2-60 V	6-15, 24-28; 6-15, 6-15; 6-15, 2-6; 2-6, 2-6; 24-28, 24-28; 24-28; 2-6	8-15, 8-15, 2-6; 8-15, 8-15, 8-15, 8-15, 18-28; 8-15, 18-28, 2-6
Standard voltage increments	25	25	25	16	18
Remote sense	Yes	Yes	Yes	Yes	No
Remote margin	Yes	Yes	Yes	No	No
V-Program - I <sup>2</sup> C control	Yes	Yes	Yes	Yes	No
Active current share	Yes	Yes	Yes	Yes	No
Module Inhibit - I <sup>2</sup> C control	Yes	Yes	Yes	Yes	Yes
Module Inhibit - analog	Yes	Yes	Yes	Yes	No
Overvoltage/overcurrent protection	Yes	Yes	Yes	Yes	Yes
Minimum load required	No	No	No	No	No
Slots occupied in any iMP case	1	2	3	1	1

\* Programmable

## Output Module Voltage/Current

Voltage	Voltage Code	Single Output Module Code				Dual Output**		Triple Output			I <sup>2</sup> C Adjustment Ranges***
		1	2	3	5+	V1	V2	-	-	-	
2 V	A	35 A	60 A	150 A	—	10 A	10 A	—	—	2 A	1.8-2.2
2.2 V	B	35 A	60 A	150 A	—	10 A	10 A	—	—	2 A	2.0-2.4
3 V	C	35 A	60 A	150 A	300 A	10 A	10 A	—	—	2 A	2.7-3.3
3.3 V	D	35 A	60 A	150 A	300 A	10 A	10 A	—	—	2 A	3.0-3.6
5 V	E	35 A	60 A	150 A	300 A	10 A	10 A	—	—	2 A	4.5-5.5
5.2 V	F	35 A	60 A	144 A	288 A	10 A	10 A	—	—	2 A	4.7-5.7
5.5 V	G	34 A	58 A	136 A	273 A	10 A	10 A	—	—	2 A	5.0-6.1
6 V	H	23 A	42 A	97.5 A	250 A	10 A*	10 A*	—	—	2 A	5.4-6.6
8 V	I	20 A	36 A	84.4 A	140 A	10 A	4 A	1 A	1 A	1 A	7.2-8.8
10 V	J	18 A	32 A	75 A	140 A	10 A	4 A	1 A	1 A	1 A	9.0-11.0
11 V	K	17 A	31 A	68 A	136.3 A	10 A	4 A	1 A	1 A	1 A	9.9-12.1
12 V	L	17 A	30 A	62.5 A	125 A	10 A	4 A	1 A	1 A	1 A	10.8-13.2
14 V	M	14 A	21 A	53.5 A	107 A	9 A	4 A	1 A	1 A	1 A	12.6-15.4
15 V	N	14 A	20 A	50 A	100 A	8 A	4 A	1 A	1 A	1 A	13.5-16.5
18 V	O	11 A	19 A	41.6 A	83.3 A	—	—	—	0.5 A	0.5 A	16.2-19.8
20 V	P	10.5 A	18 A	37.5 A	75 A	—	—	—	0.5 A	0.5 A	18.0-22.0
24 V	Q	8.5 A	15 A	30 A	62.5 A	4 A	2 A	—	0.5 A	0.5 A	21.6-26.4
28 V	R	6.7 A	11 A	26.8 A	53.5 A	3 A	2 A	—	0.5 A	0.5 A	25.2-30.8
30 V	S	6.5 A	11 A	25 A	50 A	—	—	—	—	—	27.0-33.0
33 V	T	6.2 A	10.9 A	22.7 A	35.8 A	—	—	—	—	—	29.7-36.3
36 V	U	5.8 A	10 A	20.8 A	35.8 A	—	—	—	—	—	32.4-39.6
42 V	V	4.2 A	7.5 A	16 A	35.7 A	—	—	—	—	—	37.8-46.2
48 V	W	4 A	7.5 A	15.6 A	31.2 A	—	—	—	—	—	43.2-52.8
54 V	X	3.7 A	6 A	13.9 A	27.7 A	—	—	—	—	—	48.6-59.4
60 V	Y	3.5 A	6 A	12.5 A	25 A	—	—	—	—	—	54.0-66.0
Consult Factory											
Special	Z	35 A	60 A	150 A	—	—	10 A	—	—	—	2.3-2.6
Special	Z	35 A	60 A	150 A	—	—	10 A	—	—	—	3.7-4.4
Special	Z	20 A	36 A	80 A	140 A	—	8 A	—	—	—	6.7-7.1

\* Note: Contact factory for extended range down to 6 V.  
 \*\* Total output power on dual module must not exceed 144 W.  
 \*\*\* For single output modules only.  
 + Applicable for iMP1 only.

### Parallel Codes

0 = no parallel  
 1 = 1 & 2  
 2 = 2 & 3  
 3 = 3 & 4  
 4 = 4 & 5  
 5 = 3 & 4 & 5  
 6 = 5 & 6  
 7 = 4 & 5 & 6  
 8 = 6 & 7  
 9 = 3 & 4, 6 & 7  
 A = 1 & 2, 3 & 4, 5 & 6  
 C = 2 & 3, 4 & 5  
 E = 4 & 5, 5 & 6

Increments of current not shown can be achieved by paralleling modules (add currents of each module selected).

## Ordering Information

Sample below is 1500 W case with 12 V @ 62.5 A; 5 V @ 60 A; 24 V @ 8.5 A; 12 V @ 10 A; 12 V @ 4 A; with no options.

Case Size	Module/Voltage/Option Codes First - Module Code Second - Voltage Code Third - Option Code	Case Option Codes	Software Code	Hardware Code
<b>iMP1*</b>	<b>3L0 - 2E2 - 1Q1 - 4LL0</b>	<b>00</b>	<b>A</b>	<b>###</b>
<b>Case Size (mm)</b> 4 = 2.5" x 5" x 10"; 750-1100 W, 5 slots (63.5 x 127 x 254) 8 = 2.5" x 7" x 10"; 1000-1200 W, 6 slots (63.5 x 177.8 x 254) 1 = 2.5" x 8" x 11"; 1200-1500 W, 7 slots (63.5 x 203.2 x 279.4)  *Note: Add "E" after iMP4 to denote IEC input option. e.g., iMP4E (Not available on iMP8 or iMP1)	<b>Module Codes</b> Module/voltage/option codes Module codes: (None) = 36 W triple O/P (1 slot) 1 = 210 W single O/P (1 slot) 2 = 360 W single O/P (2 slot) 3 = 750 W single O/P (3 slot) 4 = 144 W dual O/P (1 slot) 5 = 1500 W single O/P (4 slot) 6 - 9 = Future  <b>Voltage Codes:</b> See Output Module Voltage/Current table above  <b>Option Codes:</b> 0 = Standard 1 = Module enable 2 = Constant current 3 = 1 & 2 combined 4 = Set for use in standard (non-intelligent case) 5 = Shutdown mode for 1500 W 6 = 1 & 5 combined 7 - 9 = Future	<b>Case Option Codes</b>  First digit 0 - 9 = parallel code (See Parallel Codes table above)  Second digit 0 = No options 1 = Reverse air 3 = Global enable 4 = Fan idle w/inhibit 5 = Opt 1 + Opt 3 6 = Opt 1 + Opt 4 7 = Opt 3 + Opt 4 8 = Opt 1 + 3 + 4 9 = CAN BUS/RS-485 73-544-002 B = USB 73-546-002	Software code used for configuration change. "A" is standard	Factory assembled for hardware of firmware mods.
<b>Ordering Note:</b> 1. The cases and modules of both MP and iMP series can be interchanged to allow more flexibility. If intelligent modules are used with non-intelligent cases, a numeric code "4" is placed at the end of the module code (e.g., 4LL0 becomes 4LL4). 2. USB to I <sup>2</sup> C module order code 73-769-001				

# Intelligent VS Series

Intelligent modular power supply for optimum flexibility

Up to 4920 Watts

Total Power: Up to 4920 Watts  
 Input Voltage: 85-264 Vac  
 120-300 Vdc  
 # of Outputs: Up to 24

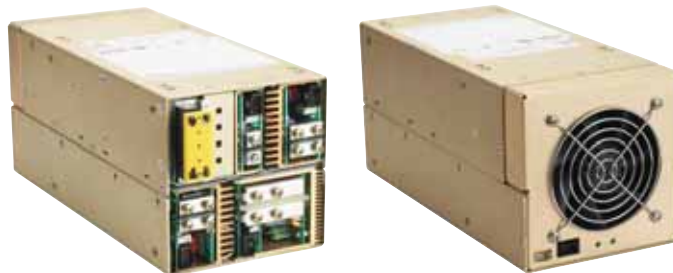

## Special Features

- Medical EN60601-1 approval
- Intelligent I<sup>2</sup>C control
- Voltage adjustment on all outputs (manual or I<sup>2</sup>C)
- Configurable input and output OK signals and indicators
- Configurable inhibit/enable
- Configurable output UP/DOWN sequencing
- High power density (12 W/cu-in)
- Intelligent fan (speed control/fault status)
- $\mu$ P controlled PFC input with active Inrush protection
- I<sup>2</sup>C monitor of voltage, current and temp
- Programmable voltage, current limit, inhibit/enable through I<sup>2</sup>C
- CAN BUS and RS-485 interface option
- Optional extended hold-up module
- (SEMI F47 compliance)
- Increased power density to 150%
- Optional conformal coating
- Industrial temp range (-40 °C to 70 °C)
- Uses standard iMP modules
- Field upgradeable firmware
- RoHS compliant

## Electrical Specifications

### Input

<i>Input range</i>	
iVS1 & iVS3:	90-264 Vac 1 $\emptyset$ : 120-300 Vdc
iVS6 & iVS8:	170-264 Vac 3 $\emptyset$
Frequency	47-440 Hz
Inrush current	40 A peak maximum (soft start)
Efficiency	Up to 85% @ full case load
Power factor	0.99 typ. meets EN61000-3-2
Turn-on time	AC on 1.5 sec typical, inhibit/enable 150 ms typical. Programmable
EMI Filter	CISPR 22/EN55022 Level "B"
Leakage current	300 $\mu$ A max. @ 240 Vac; 47-63 Hz
Radiated EMI	CISPR 22/EN55022 Level "B"
Holdover storage	10 ms minimum (independent of input Vac) additional 20 ms holdover storage with optional HUP module (SEMI F47 compatible)
AC OK	>5 ms early warning minutes before outputs lose regulation. Full cycle ride thru (50 Hz). Programmable
Harmonic distortion	Meets EN61000-3-2
Isolation	Meets EN60950 and EN60601
Global inhibit/enable	TTL, Logic "1" and Logic "0"/configurable
Warranty	Three years



210 W



360 W



750 W



1500 W

### Single

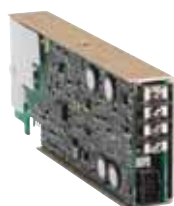

144 W

### Dual



36 W

### Triple

Output	
Adjustment range*	±10% minimum all outputs (manual) (full module adjustment range using I <sup>2</sup> C)
Margining	±4-6% nominal analog (single output module only)
Overall regulation	0.4% or 20 mV max. (1500 W modules 1% max.)
Ripple	RMS: 0.1% or 10 mV, whichever is greater Pk-Pk: 1.0% or 50 mV, whichever is greater Bandwidth limited to 20 MHz
Dynamic response	<2% or 100 mV, with 25% load step
Recovery time	To within 1% in <300 μs
Overcurrent protection**	Configurable through I <sup>2</sup> C. single output module and main output of the dual output module 105-120% of rated output current. Aux output of dual output module 105-140% of rated output current. Special programmable OCP delay on 1500 W module from 100 ms to 25.5 seconds with shutdown features
Short-circuit protection	Protected for continuous short-circuit Recovery is automatic upon removal of short (Shutdown mode on 1500 W module)
Overvoltage protection*	Configurable through I <sup>2</sup> C – Single output module 2-5.5 V 122-134%; 6-60 V 110-120% – Dual output module 2-6 V 122-134%; 8-28 V 110-120% – Triple output module No overvoltage protection provided
Thermal protection*	Configurable through I <sup>2</sup> C All outputs disabled when internal temp exceeds safe operating range. > 5 ms warning (AC OK signal) before shutdown
Remote sense	Up to 0.5 V total drop (not available on triple output module)
Single wire parallel	Current share to within 2% of total rated current
DC OK*	±5% of nominal. Configurable through I <sup>2</sup> C
Minimum load	Not required
Housekeeping bias voltage	5 Vdc @1.0 A max. present whenever AC input is applied
Module inhibit*	Configured and controlled through I <sup>2</sup> C
Output/Output isolation	>1 Megohm, 500 V

\* Can be controlled via I<sup>2</sup>C

\*\* Controlled via I<sup>2</sup>C but requires load calibration

## Environmental Specifications

Operating temperature	-40 °C to 70 °C ambient. Derate each output 2.5% per degree from 50 °C to 70 °C. (-20 °C start up)
Storage temperature	-40 °C to 85 °C
Electromagnetic susceptibility	Designed to meet EN61000-4; -2, -3, -4, -5, -6, -8, -11 Level 3
Humidity	Operating; non-condensing 10% to 95% RH
Vibration	IEC68-2-6 to the levels of IEC721-3-2
MTBF demonstrated	>550,000 hours at full load, 220 Vac and 25 °C ambient conditions

## Safety

UL	UL60950/UL2601
CSA	CSA22.2 No. 234 Level 5
VDE	EN60950/EN60601-1
BABT	Compliance to EN60950/ EN60601 BS7002
CB	Certificate and report
CE	Mark to LVD

## Output Module Line-up

Module Code	1	2	3	5	4	
Module Type	Single	Single	Single	Single	Dual	Triple
Max output power	210 W	360 W	750 W	1500 W	144 W	36 W
Max output current	35 A	60 A	150 A	300 A	10 A	2 A
Output voltages available*	2-60 V	2-60 V	2-60 V	3-60 V	6-15, 24-28; 6-15; 6-15; 6-15; 2-6; 2-6, 2-6; 24-28, 24-28; 24-28; 2-6	8-15, 8-15, 2-6; 8-15, 8-15, 8-15; 8-15, 8-15, 18-28; 8-15, 18-28, 2-6
Standard voltage increments	25	25	25	18	16	18
Remote sense	Yes	Yes	Yes	Yes	Yes	Yes
Remote margin*	Yes	Yes	Yes	Yes	No	No
V-Program - I <sup>2</sup> C Control*	Yes	Yes	Yes	Yes	Yes	Yes
Active Current Share	Yes	Yes	Yes	Yes	Yes	No
Module Inhibit - I <sup>2</sup> C Control*	Yes	Yes	Yes	Yes	Yes	Yes
Module Inhibit - Analog	Yes	Yes	Yes	Yes	No	No
Overvoltage/Overcurrent protection*	Yes	Yes	Yes	Yes	Yes	Yes
Minimum load required	No	No	No	No	No	No
Slots occupied in any iMP case	1	2	3	4	1	1

\* Programmable





## Output Module Voltage/Current

Voltage	Voltage Code	Single Output Module Code				Dual Output**		Triple Output			I <sup>2</sup> C Adjustment Ranges***
		1	2	3	5	V1	V2				
2 V	A	35 A	60 A	150 A	—	10 A	10 A	—	—	2 A	1.8-2.2
2.2 V	B	35 A	60 A	150 A	—	10 A	10 A	—	—	2 A	2.0-2.4
3 V	C	35 A	60 A	150 A	300 A	10 A	10 A	—	—	2 A	2.7-3.3
3.3 V	D	35 A	60 A	150 A	300 A	10 A	10 A	—	—	2 A	3.0-3.6
5 V	E	35 A	60 A	150 A	300 A	10 A	10 A	—	—	2 A	4.5-5.5
5.2 V	F	35 A	60 A	144 A	288 A	10 A	10 A	—	—	2 A	4.7-5.7
5.5 V	G	34 A	58 A	136 A	273 A	10 A	10 A	—	—	2 A	5.0-6.1
6 V	H	23 A	42 A	97.5 A	250 A	10 A*	10 A*	—	—	2 A	5.4-6.6
8 V	I	20 A	36 A	84.4 A	140 A	10 A	4 A	1 A	1 A	1 A	7.2-8.8
10 V	J	18 A	32 A	75 A	140 A	10 A	4 A	1 A	1 A	1 A	9.0-11.0
11 V	K	17 A	31 A	68 A	136.3 A	10 A	4 A	1 A	1 A	1 A	9.9-12.1
12 V	L	17 A	30 A	62.5 A	125 A	10 A	4 A	1 A	1 A	1 A	10.8-13.2
14 V	M	14 A	21 A	53.5 A	107 A	9 A	4 A	1 A	1 A	1 A	12.6-15.4
15 V	N	14 A	20 A	50 A	100 A	8 A	4 A	1 A	1 A	1 A	13.5-16.5
18 V	O	11 A	19 A	41.6 A	83.3 A	—	—	—	0.5 A	0.5 A	16.2-19.8
20 V	P	10.5 A	18 A	37.5 A	75 A	—	—	—	0.5 A	0.5 A	18.0-22.0
24 V	Q	8.5 A	15 A	30 A	62.5 A	4 A	2 A	—	0.5 A	0.5 A	21.6-26.4
28 V	R	6.7 A	11 A	26.8 A	53.5 A	3 A	2 A	—	0.5 A	0.5 A	25.2-30.8
30 V	S	6.5 A	11 A	25 A	50 A	—	—	—	—	—	27.0-33.0
33 V	T	6.2 A	10.9 A	22.7 A	35.8 A	—	—	—	—	—	29.7-36.3
36 V	U	5.8 A	10 A	20.8 A	35.8 A	—	—	—	—	—	32.4-39.6
42 V	V	4.2 A	7.5 A	16 A	35.7 A	—	—	—	—	—	37.8-46.2
48 V	W	4 A	7.5 A	15.6 A	31.2 A	—	—	—	—	—	43.2-52.8
54 V	X	3.7 A	6 A	13.9 A	27.7 A	—	—	—	—	—	48.6-59.4
60 V	Y	3.5 A	6 A	12.5 A	25 A	—	—	—	—	—	54.0-66.0
<b>Consult Factory</b>											
Special	Z	35 A	60 A	150 A	—	—	10 A	—	—	—	2.3-2.6
Special	Z	35 A	60 A	150 A	—	—	10 A	—	—	—	3.7-4.4
Special	Z	20 A	36 A	80 A	140 A	—	8 A	—	—	—	6.7-7.1

\* Note: Consult factory for extended range down to 6V.  
 \*\* Total output power on dual model must not exceed 144 W.  
 \*\*\* For single output modules only.

## Ordering Information

Sample below is 3210 W case with 12 V @ 125 A; 24 V @ 8.5 A; 5 V @ 60 A; 12 V @ 10 A and 12 V @ 4 A; with no options.

Case Size	Module/Voltage/Option Codes First - Module Code Second - Voltage Code Third - Option Code	Case Option Codes	Software Code	Hardware Code
<b>iVS1</b>	<b>5L1 - 1Q1 - 2EO - 4LL0</b>	<b>00</b>	<b>A</b>	<b>###</b>
<p><b>Case Size (mm)</b>  <b>1-Phase Input</b>                      1 = 5" x 5" x 11"; 1500-3210 W, 9 slots (127 x 127 x 279.4)                      3 = 5" x 8" x 11"; 1800-4920 W, 14 slots (127 x 203.2 x 279.4)  <b>3-Phase Input*</b>                      6 = 5" x 5" x 11"; 3120 W, 9 slots (127 x 127 x 279.4)                      8 = 5" x 8" x 11"; 4920 W, 14 slots (127 x 203.2 x 279.4)</p> <p>*3-phase versions not medically approved</p>	<p><b>Module Codes</b>                      Module/voltage/option codes                      Module Codes:                      (None) = 36 W triple O/P (1 slot)                      1 = 210 W single O/P (1 slot)                      2 = 360 W single O/P (2 slot)                      3 = 750 W single O/P (3 slot)                      5 = 1500 W single O/P (slot 4)                      4 = 144 W dual O/P (1 slot)                      HUP = Extra 30mS hold-up (1 slot)</p> <p><b>Voltage Codes:</b>                      See Output Module Voltage/Current table above</p> <p><b>Option Codes:</b>                      0 = Standard                      1 = Module enable                      2 = Constant current                      3 = 1 &amp; 2 combined                      4 = Set for use in standard (non-intelligent case)                      5 = Shutdown mode for 1500 W                      6 = 1 &amp; 5 combined                      7-9 = Future</p>	<p><b>Case Option Codes</b>                      First Digit                      0 - 9 = Parallel code (See parallel codes table in datasheet)</p> <p>Second Digit                      0 = No options                      1 = Reverse air                      2 = Not used                      3 = Global enable                      4 = Fan idle w/inhibit                      5 = Opt 1 + Opt 3                      6 = Opt 1 + Opt 4                      7 = Opt 3 + Opt 4                      8 = Opt 1 + 3 + 4                      9 = RS485 73-544-001                      B = USB 73-546-001                      C = 9 + 3                      D = CANBus 73-544-004                      E = D + 3</p>	<p>Software code used for configuration change. "A" is standard</p>	<p>Factory assembled for hardware of firmware mods.</p>
<p><b>Ordering Note:</b>                      1. USB to I<sup>2</sup>C module order code 73-769-001</p>				

# LCM300

Bulk front end

310 Watts

Total Power: 310 W  
 # of Outputs: Single  
 Output: 12 to 60 V  
 Optional 5.0 V standby

NEW!



RoHS

## Special Features

- 310 W (350W Peak) output power
- Low Cost
- 1.61" x 4.0" x 7.0"
- 7.1 Watts Per Cubic Inch
- Industrial/Medical Safety
- -40 °C to 70 °C with derating
- Optional 5 V @ 2 A Housekeeping
- High Efficiency: 91% @ 230 VAC
- Variable speed "Smart Fans"
- DSP controlled
- PMBus Compliant
- Conformal coat option
- ± 20% adjustment range
- Margin programming
- OR-ing FET
- EMI Class B
- EN61000 Immunity
- RoHS 2
- PMBUS

## Electrical Specifications

Input	
Input range	90 - 264 Vac (Operating) (127-374 Vdc) 115/230 Vac (Nominal) TERMINAL BLOCK
Frequency	47 - 63 Hz, Nominal 50/60
Input fusing	Internal 8 A fuses, both lines fused
Inrush current	≤ 20 A peak, either hot or cold start
Power factor	0.98 typical, meets EN61000-3-2
Harmonics	Meets IEC 1000-3-2 requirements
Input current	5 Arms max input current, at 90 Vac
Hold up time	20 ms minimum for Main O/P, at full rated load
Efficiency	> 91% typical at full Load/230 Vac nominal
Leakage current	< 0.3 mA at 264 Vac
ON/OFF power switch	N/A
Power line transient	MOV directly after the fuse
Isolation	PRI-Chassis 2500 Vdc Basic PRI-SEC 2500 Vdc Reinforced SEC-Chassis 500 Vdc

## Environmental Specifications

Operating temperature	-40 °C to +70 °C, linear derating to 50% from 50 °C to 70 °C
Storage temperature	-40 °C to +85 °C
Humidity	20 to 90%, non-condensing. Operating. Conformal coat option available
Fan noise	< 45 dBA, 80% load at 40 °C; Fan Off when unit is inhibited
Altitude	Operating - 16,405 feet (3000m) Storage - 30,000 feet
Shock	MIL-STD-810F 516.5, Procedure I, VI. Storage
Vibration	MIL-STD-810F 514.5, Cat. 4, 10. Storage

## Safety

UL	60950-1 508/1598/1433 60601-1 Ed 3
CSA	60950-1
VDE	60950-1 60601
China	CCC
CB Scheme	Report/Cert

## Electrical Specifications

Output		
Output rating	See ordering information table below	90-264 Vac
Set point	±0.5%	90-264 Vac
Total regulation range	Main output ±2% 5 Vsb ±1%	Combined line/load/transient when measured at output terminal
Rated load	310 W maximum	Derate linear to 50% from 50 °C to 70 °C
Minimum load	Main output @ 0.0 A 5 Vsb @ 0.0 A	No loss of regulation
Output noise (PARD)	1% max p-p 50 mV max p-p	Main output 5 Vsb output Measured with a 0.1 µF ceramic and 10 µF tantalum capacitor on any output, 20 MHz
Output voltage overshoot	—	No overshoot/undershoot outside the regulation band during on or off cycle
Transient response	<300 µs	50% load step @ 1 A/µs Step load valid between 10% to 100% of output rating Recovery time to within 1% of set point at onset of transient
Max units in parallel	—	Up to 10
Short circuit protection	Protection against damage	Bounce mode
Remote sense	—	Compensation up to 500 mV
Output isolation	—	Standard per safety requirements
Forced load sharing	To within 10% of all shared outputs	Analog sharing control
Overload protection (OCP)	105% to 125% 120% to 170%	Main output 5 Vsb output
Overvoltage protection (OVP)	125% to 145% 110% to 125%	12 V output 5 Vsb output
Overtemp protection	10-15 °C above safe operating area	Both PFC and output converter monitored

## Ordering Information

Model Number*	Output	Nominal Output Voltage Set Point	Set Point Tolerance	Adjustment Range	Current		Output Ripple P/P (0-50 °C)	Max Continuous Power	Combined Line/ Load Regulation
					Min	Max			
LCM300L	12 V	12 V	±0.5%	±0.5%	0 A	25 A	120 mV	310	2%
LCM300N	15 V	15 V	±0.5%	±0.5%	0 A	20 A	150 mV	310	2%
LCM300Q	24 V	24 V	±0.5%	±0.5%	0 A	12.5 A	240 mV	310	2%
LCM300U	36 V	36 V	±0.5%	±0.5%	0 A	8.4 A	360 mV	310	2%
LCM300W	48 V	48 V	±0.5%	±0.5%	0 A	6.3 A	480 mV	310	2%

\* "-T" for terminal block instead of IEC input

\* "-4" for 5 Vsb Option

\* "-N" for Low Noise Fan Option

# LCM600

Bulk front end

600 Watts

Total Power: 600 Watts  
 # of Outputs: Single  
 Output: 3.3-60 V  
 Optional 5.0 V standby

**NEW!**



## Special Features

- 600 W output power
- Low cost
- 2.4" x 4.5" x 7.5"
- 7.41 W/cu-in
- 5 V SELV standby (housekeeping)
- Industrial/Medical safety
- -40 °C to 70 °C with derating
- 5 V housekeeping
- High efficiency: 89% typical
- Variable speed "Smart Fans"
- DSP controlled front end
- Conformal coat option
- ±20% adjustment range
- Margin programming
- OR-ing FET option
- Terminal block input option

## Electrical Specifications

Input	
Input range	85-264 Vac (Operating) 115/230 Vac (Nominal) Input through standard IEC connector
Frequency	47-440 Hz, Nominal 50/60
Input fusing	Internal 10 A fuses, both lines fused
Inrush current	≤25 A peak, either hot or cold start
Power factor	0.99 typical, meets EN61000-3-2
Harmonics	Meets IEC 1000-3-2 requirements
Input current	8 A RMS max input current, at 100 Vac
Hold up time	20 ms minimum for Main O/P, at full rated load
Efficiency	>88% at full load
Leakage current	<0.3 mA at 264 Vac
ON/OFF power switch	N/A
Power line transient	MOV directly after the fuse



## Environmental Specifications

Operating temperature	-40 °C to +70 °C, linear derating to 50% from 50 °C to 70 °C
Storage temperature	-40 °C to 85 °C
Humidity	20 to 90%, non-condensing. Operating. Conformal coat option available
Fan noise	<45 dBA, 80% load at 30 °C
Altitude	Operating: Up to 15,000 feet above sea level Storage: Up to 30,000 feet above sea level
Shock	MIL-STD-810F 516.5, Procedure I, VI. Storage
Vibration	MIL-STD-810F 514.5, Cat. 4, 10. Storage

## Safety

UL	60950-1 508/1598/1433 60601-1
CSA	60950-1
VDE	60950-1 60601
China	CCC
CB Scheme	Report/Cert

## Electrical Specifications

Output		
Output rating	See ordering information table below	85-264 Vac
Set point	±0.5%	85-264 Vac
Total regulation range	Main output ±2% 5 Vsb ±1%	Combined line/load/transient when measured at output terminal
Rated load	600 W maximum	Derate linear to 50% from 50 °C to 70 °C
Minimum load	Main output @ 0.0 A 5 Vsb @ 0.0 A	No loss of regulation
Output noise (PARD)	1% max p-p 50 mV max p-p	Main output 5 Vsb output Measured with a 0.1 µF ceramic and 10 µF tantalum capacitor on any output, 20 MHz
Output voltage overshoot	—	No overshoot/undershoot outside the regulation band during on or off cycle
Transient response	<300 µs	50% load step @ 1 A/µs Step load valid between 10% to 100% of output rating Recovery time to within 1% of set point at onset of transient
Max units in parallel	—	Up to 10
Short circuit protection	Protection against damage	Bounce mode
Remote sense	—	Compensation up to 500 mV
Output isolation	—	Standard per safety requirements
Forced load sharing	To within 10% of all shared outputs	Analog sharing control
Overload protection (OCP)	105% to 125% 120% to 170%	Main output 5 Vsb output
Overvoltage protection (OVP)	125% to 145% 110% to 125%	12 V output 5 Vsb output
Overtemp protection	10-15 °C above safe operating area	Both PFC and output converter monitored

## Ordering Information

Model Number*	Output	Nominal Output Voltage Set Point	Set Point Tolerance	Adjustment Range	Current		Output Ripple P/P (0-50 °C)	Combined Line/ Load Regulation
					Min	Max		
LCM600L	12 V	12 V	±0.5%	9.6–14.4 V	0 A	54 A	120 mV	2%
LCM600N	15 V	15 V	±0.5%	12.0–19.5 V	0 A	44 A	150 mV	2%
LCM600Q	24 V	24 V	±0.5%	19.2–28.8 V	0 A	27 A	240 mV	2%
LCM600U	36 V	36 V	±0.5%	28.8–43.2 V	0 A	16.7 A	240 mV	2%
LCM600W	48 V	48 V	±0.5%	38.4–57.6 V	0 A	14 A	280 mV	2%

\* "-T" for terminal block instead of IEC input

\* "-4" for 5 Vsb Option

\* "-N" for Low Noise Fan Option



# LCM1500

Bulk front end

1500 Watts

Total Power: 1500 W  
 # of Outputs: Single  
 Output: 12 to 60 V  
 Optional 5.0 V standby

NEW!



RoHS

## Special Features

- 1500 W output power
- Low Cost
- 2.5" x 5.2" x 10.0"
- 12 Watts Per Cubic Inch
- Industrial/Medical safety
- -40 °C to 70 °C with derating
- Optional 5 V @ 2 A Housekeeping
- High Efficiency: 89% typical
- Variable speed "Smart Fans"
- DSP controlled
- Conformal coat option
- ±10% adjustment range
- Margin programming
- OR-ing FET
- Compliance
  - EMI Class B
  - EN61000 Immunity
  - RoHS 2
  - PMBUS

## Electrical Specifications

Input	
Input range	90 - 264 Vac (Operating) 115/230 Vac (Nominal) TERMINAL BLOCK
Frequency	47 - 440 Hz, Nominal 50/60
Input fusing	Internal 20 A fuses, both lines fused
Inrush current	≤ 25 A peak, either hot or cold start
Power factor	0.99 typical, meets EN61000-3-2
Harmonics	Meets IEC 1000-3-2 requirements
Input current	18 Arms max input current, at 100 Vac
Hold up time	20 ms minimum for Main O/P, at full rated load
Efficiency	> 91% typical at full Load/230 Vac nominal
Leakage current	< 0.3 mA at 264 Vac
ON/OFF power switch	N/A
Power line transient	MOV directly after the fuse
Isolation	PRI-Chassis 2500 Vdc Basic PRI-SEC 2500 Vdc Reinforced SEC-Chassis 500 Vdc

## Environmental Specifications

Operating temperature	-40 °C to +70 °C, linear derating to 50% from 50 °C to 70 °C
Storage temperature	-40 °C to +85 °C
Humidity	20 to 90%, non-condensing. Operating. Conformal coat option available
Fan noise	< 45 dBA, 80% load at 30 °C
Altitude	Operating - 16,405 feet (3000m) Storage - 30,000 feet
Shock	MIL-STD-810F 516.5, Procedure I, VI. Storage
Vibration	MIL-STD-810F 514.5, Cat. 4, 10. Storage

## Safety

UL	60950-1 508/1598/1433 60601-1 Ed 3
CSA	60950-1
VDE	60950-1 60601
China	CCC
CB Scheme	Report/Cert

## Electrical Specifications

Output		
Output rating	See ordering information table below	90-264 Vac
Set point	±0.5%	90-264 Vac
Total regulation range	Main output ±2% 5 Vsb ±1%	Combined line/load/transient when measured at output terminal
Rated load	1500 W maximum	Derate linear to 50% from 50 °C to 70 °C
Minimum load	Main output @ 0.0 A 5 Vsb @ 0.0 A	No loss of regulation
Output noise (PARD)	1% max p-p 50 mV max p-p	Main output 5 Vsb output Measured with a 0.1 µF ceramic and 10 µF tantalum capacitor on any output, 20 MHz
Output voltage overshoot	—	No overshoot/undershoot outside the regulation band during on or off cycle
Transient response	<300 µs	50% load step @ 1 A/µs Step load valid between 10% to 100% of output rating Recovery time to within 1% of set point at onset of transient
Max units in parallel	—	Up to 10
Short circuit protection	Protection against damage	Bounce mode
Remote sense	—	Compensation up to 500 mV
Output isolation	—	Standard per safety requirements
Forced load sharing	To within 10% of all shared outputs	Analog sharing control
Overload protection (OCP)	105% to 125% 120% to 170%	Main output 5 Vsb output
Overvoltage protection (OVP)	125% to 145% 110% to 125%	12 V output 5 Vsb output
Overtemp protection	10-15 °C above safe operating area	Both PFC and output converter monitored

## Ordering Information

Model Number*	Output	Nominal Output Voltage Set Point	Set Point Tolerance	Adjustment Range	Current		Output Ripple P/P (0-50 °C)	Max Continuous Power	Combined Line/Load Regulation
					Min	Max			
LCM1500L	12 V	12 V	±0.5%	10.8–13.2 V	0 A	133 A	120 mV	1500	2%
LCM1500N	15 V	15 V	±0.5%	13.5–16.5 V	0 A	100 A	150 mV	1500	2%
LCM1500Q	24 V	24 V	±0.5%	21.6–26.4 V	0 A	67 A	240 mV	1500	2%
LCM1500R	28 V	28 V	±0.5%	25.2–30.8 V	0 A	53.6 A	280 mV	1500	2%
LCM1500U	36 V	36 V	±0.5%	32.4–39.6 V	0 A	43 A	360 mV	1500	2%
LCM1500W	48 V	48 V	±0.5%	43.2–52.8 V	0 A	33 A	480 mV	1500	2%

\* "-T" for terminal block instead of IEC input

\* "-4" for 5 Vsb Option

\* "-N" for Low Noise Fan Option

# HPS & UFE

Distributed power bulk front end

3000-12000 Watts

## Special Features

- EN61000-3-2 harmonic compliance
- Built-in EMI filter
- Low output ripple
- +5 V standby output
- Built-in cooling fans
- Hot swap/N + 1 redundant
- Overcurrent protection
- Overvoltage protection
- Overtemperature protection
- Built-in OR-ing diodes
- Active power factor correction



## Voltage Availability

Model	HPS3000	UFE
Wattage	3000 W <sup>3</sup>	2000 W <sup>4</sup>
Input Voltage	90-140 Vac 180-264 Vac	90-265 Vac
<b>Available Standard Output Voltages (order code)<sup>1</sup></b>		
12 (L)		
24 (Q)		•
28 (R)		•
30 (S)		
48 (W)	•	•
54 (X)		•
60 (Y)		
Available Options	See Note 1	
Corresponding Rack	See Note 2	UFR6000J

Notes: 1 = Consult factory for other output voltages and options  
 2 = Comes with optional I<sup>2</sup>C interface  
 3 = 3000 W @ 180-264 Vac; 1500 W @ 90-140 Vac  
 4 = 2000 W @ 48 V; 1300 W @ 24 V

## HPS3000 Electrical Specifications

Input	
Input range (operating)	180-264 Vac 90-140 Vac
Input range (nominal)	200 Vac 110 Vac
Frequency	43-63 Hz
Input fusing	Internal 25 A fuses (both lines fused)
Inrush current	≤40 A peak (either hot or cold start)
Power factor	0.97 typical (Meets EN61000-3-2)
Harmonics	Meets IEC 1000-3-2 requirements @ 50% load
Input current	19 A max input current
Holdup time	10 ms min @ full rated load
Leakage current	1.4 mA @ 240 Vac
Power line transient	MOV directly after the fuse

## Environmental Specifications

HPS3000	
Operating temp.	-10 °C to 40 °C
Storage temp.	-40 °C to 85 °C
Cooling	External fans with Fan Fail and Fan Speed control
Humidity	Operating/Storage: 5-95% non-condensing
Altitude	Operating: Up to 10,000 feet above sea level Storage: Up to 30,000 feet above sea level
Vibration/Shock	Non-operational 5G Sine sweep from 5-500 Hz, dwelling at resonant frequencies for one hour each
RoHS compliant	Yes

## Safety

UL	UL60950 (UL recognized)
NEMKO	EN60950
TÜV	EN60950
CE	Mark
CB	Report



HPR12K



Output	
Output rating	48 V @ 62.0 A (180-264 Vac) 5 Vsb @ 3.0 A 48 V @ 29.4 A (90-140 Vac) 5 V @ 3 A
Set point	-4% to +17% through I <sup>2</sup> C
Total regulation range	48 V ±10%; 5 Vsb ±4% (line/load/transient when measured at output connection)
Rated load	3000 W maximum @ 200 Vac Input 1500 W maximum @ 110 Vac Input (no derating over operating temperature range)
Minimum load	48 V @ 0.0 A; 5 Vsb @ 0.0 A with no loss of regulation
Output noise	480 mV max P-P for 48 V output 100 mV max P-P for 5 Vsb output Measured with a 0.1µF Ceramic and 10 µF Tantalum capacitor on any input
Output voltage overshoot	±5% maximum of nominal voltage setting
Transient response	5% maximum deviation (50% load step @ 1 A/us. Step load valid between 10-100% of output rating)
Max units in parallel	Up to 4 (total power in 1U 19" rack is 12 KW)
Short circuit protection	120-130% of rated output (output to return)
Output isolation	Per POE specs (>2000 Vac)
Forced load sharing	Within 10% of all shared outputs (digital sharing control)
Overcurrent protection (OCP)	120-130% for 48 V output 100-125% for 5 Vsb output
Overvoltage protection (OVP)	110-120% for 48 V output 110-125% for 5 Vsb output
Overtemperature protection	10 °C to 15 °C above safe operating area. (Both PFC and output converter monitored. 5 Vsb will operate under overtemperature condition. Built-in hysteresis.)

### Rack Ordering Information

Module	UFE1300/2000	HPS3000
Rack #	UFR6000	HPR12K
# of Slots	3	4
Total Power	6000 W	12000 W

\*\* See website for option codes on HPR racks.

### Ordering Information

HPS3000-0-001	HPS3000-0-001
HPS3000	HPS3000-9

## UFE1300/2000 Electrical Specifications

Input	
Input range (operating)	88-264 Vac 176-264 Vac
Input range (nominal)	120 Vac 240 Vac
Frequency	47-63 Hz
Input fusing	30 A (both lines fused)
Power factor	0.98 (50-100% load)
Input current	15 A max.
Leakage current	2 mA max.
Undervoltage lockout (power up)	176 Vac max. (high line range) 88 Vac max. (wide range)
Undervoltage lockout (power down)	162 Vac min. (high line range) 76 Vac min. (wide range)

Output	
Output rating - Main output	48 V 2000 W (high line range) 48 V 1300 W (wide range) 24 V 1300 W (all ranges)
Output rating - Auxiliary output	11 V $\pm$ 15%, 2.875 W
Line regulation	$\pm$ 0.15% max.
Load regulation	$\pm$ 0.15% max.
Turn-on delay	5.0 seconds max.
Ambient temp. coefficient	$\pm$ 0.005%/°C
Voltage adjustability (via PMBus)	48 V 42-57 Vdc 24 V 21-28.5 Vdc
Output setpoint accuracy	$\pm$ 0.5%
Default output voltage (@ 25 °C)	48 V $\pm$ 0.5% @ 41 A 27 V $\pm$ 0.5% @ 48 A
Total error band	$\pm$ 1.0% max.
Overshoot/undershoot	0%
Ripple and noise (20 MHz)	500 mV pk-pk, 150 mV rms
Dynamic regulation (except droop mode)	2.5% max., recovery in 1 ms max.
Current sharing	15% max.
Electrical insulation	4242 Vdc input/output
Switching frequency	450 kHz fixed
Power limit	115%
Current limit	108% typical
Short-circuit	200 ms on; 1/8 second off
Overshoot	60 V/32 V
Overtemperature	Non-latching

UFE Power Shelf



UFE2000

## Ordering Information

Rated Output Power	Output Voltage Vout		Output Current (Min)	Power Limit + 15% / -0% Vout (min)	Line Range at Turn On (Auto Ranging)	Operating Line Range	Current Limit (Vout) < Vout (min)	Model Numbers	Order Number
	Min	Max							
<b>24 Vout Models</b>									
1300 W	21 V	28.5 V	0 A	1300 W	90-264 Vac	65 A	65 A	UFE1300-96S24PJ	UFE1300-5
<b>48 Vout Models</b>									
1300 W	42 V	57 V	0 A	1300 W	90-264 Vac	33 A	33 A	UFE2000-96S48PJ	UFE2000-9
2000 W	42 V	57 V	0 A	2000 W	180-264 Vac	52 A	52 A		
1300 W	42 V	57 V	0 A	1300 W	90-264 Vac	33 A	33 A	UFE2000-96S48PDJ	UFE2000-9-HD
2000 W	42 V	57 V	0 A	2000 W	180-264 Vac	52 A	52 A		
1300 W	42 V	57 V	0 A	1300 W	90-264 Vac	33 A	33 A	UFE2000-96S48PHDJ	UFE2000-9-D
2000 W	42 V	57 V	0 A	2000 W	180-264 Vac	52 A	52 A		

Product Family	Rated Output Power	Input Range	Standard Compliance	Type of Output	Output Voltage	Communications Type	Option Code	Special Modification	RoHS Compliance
<b>UFE</b>	<b>2000</b>	<b>9</b>	<b>6</b>	<b>S</b>	<b>48</b>	<b>P</b>	<b>D</b>	<b>XX</b>	<b>J</b>
UFE = Universal Front-End	1300 = 1300 Watts 2000 = 2000 Watts	9 = Universal Input with PFC	6 = UL/CSA/VDE Class A/B	S = Single	48 = 48 V 24 = 24 V	P = PMBus serial communications	None = Active Ishare D = Droop Ishare HD = PS Enable HI/Droop		J = Pb free (RoHS 6/6 compliant)



# Distributed Power Systems (DS)

AC and DC inputs available

450-2900 Watts



DS450DC/DS2900



## Special Features

- Active power factor correction
- EN61000-3-2 harmonic compliance
- Active AC inrush control
- High density
- Outputs +12 Vdc with some +48 Vdc models available
- 3.3 Vdc standby
- Options for 5 V standby voltage
- No minimum load required
- Hot plug operation
- N+1 redundant
- Internal OR-ing FETs
- Active current sharing
- Built-in cooling fans
- I<sup>2</sup>C Interface with EEPROM for FRU data
- Internal fan speed control with fan fail signal
- DC Input
- DSR1 rack for DS650/850. Ordering part number is 73-762-002. Standard 19" 1U fits up to 5 modules (4250 Watts)
- Gold efficiency standards on some models
- Options for reverse airflow
- Options for 5 V standby
- Platinum Plus efficiency on some models

## Voltage Availability

Model	12 V (-3)	24 V (-5)	48 V (-9)	PMBus
DS450 (HE)	•			
DS450DC	•			
DS460S	•			•
DS460SDC	•			•
DS550 (HE)	•			
DS550DC	•			
DS650	•	•	•	
DS650DC	•			
DS750PED	•			
DS760SL	•			
DS800SL	•			•
DS850	•	•	•	
DS850DC	•			
DS1050	•			•
DS1100PED	•			
DS1200	•			•
DS1200DC	•			•
DS1500	•			
DS2000	•			•
DS2900	•			•

Notes: • Available

## Safety

UL	UL60950 (UL recognized)
NEMKO	EN60950
TÜV	EN60950
CE	Mark
CB	Report





DS460

DS550

**NEW!**

## Electrical Specifications

	DS450-3	DS450DC-3	DS460S-3	DS460SDC	DS550SPE-3	DS550-3
<b>Input</b>						
Input Range	90-264 Vac	40-72 Vdc	90-264 Vac	40-72 Vdc	90-264 Vac	90-264 Vac
Frequency	47-63 Hz	DC	47-63 Hz	DC	47-63 Hz	47-63 Hz
Efficiency	80% Typ	80% Typ	92% Typ	92% Typ	94% Typ	80% Typ
EMI/RFI	Class B	N/A	Class B	N/A	Class A	Class B
Leakage Current	1.4 mA @ 240 V	N/A	1.0 mA @ 240 V	N/A	1.75 mA @ 240 V	1.4 mA @ 240 V
<b>Outputs</b>						
Output Main	12 V / 37 A	12 V / 37 A	12 V / 38.2 A	12 V / 38.2 A	12 V / 41.6 A	12 V / 45 A
Output Stand-By	3.3 Vsb / 3 A	3.3 Vsb / 3 A	12 Vsb / 2.5 A	12 Vsb / 2.5 A	12 V / 4.5 A	3.3 Vsb / 3 A
OCP/OVP/OTP	YES	YES	YES	YES	YES	YES
I <sup>2</sup> C Control	YES	YES	YES	YES	YES	YES
<b>Environmental</b>						
Operating Temp	-10 °C to 50 °C	-10 °C to 50 °C	-10 °C to 50 °C	-10 °C to 50 °C	0 °C to 50 °C	-10 °C to 50 °C
Derating	N/A	N/A	N/A	N/A	50 °C to 70 °C	N/A
Storage	-40 °C to +85 °C	-40 °C to +85 °C	-40 °C to +85 °C	-40 °C to +85 °C	-40 °C to +85 °C	-40 °C to +85 °C
RoHS Compliant	YES	YES	YES	YES	YES	YES
MTBF	300K Hours	500K Hours	500K Hours	500K Hours	200K Hours	300K Hours
<b>Other</b>						
Size (inch)	1.57 x 3.07 x 11.05	1.57 x 3.07 x 11.05	1.57 x 3.4 x 7.75	1.57 x 3.4 x 7.75	1.57 x 3.39 x 7.73	1.57 x 3.07 x 11.05
Size (mm)	40 x 78 x 280	40 x 78 x 280	40 x 86.4 x 197	40 x 86.4 x 197	40 x 86.3 x 196.5	40 x 78 x 280
Power Density	8.42	8.42	11.12	11.12	12.15362178	10.30
Cubic Inches	53.42	53.42	41.37	41.37	41.14	53.42
Pro-E Files	NO	YES	YES	YES	YES	NO
Thermal Data	YES	YES	YES	YES	YES	YES
PQ Airflow Curves	YES	YES	YES	YES	YES	YES
Warranty	Two Years	Two Years	Two Years	Two Years	Two Years	Two Years
<b>Ordering Codes</b>						
Standard	DS450-3	DS450DC-3	DS460S-3-002	DS460SDC-3	DS550SPE-3	DS550-3
ALT Standby	DS450-3-001					
Reverse Air	DS450-3-002	DS450DC-3-002	DS460S-3-003	DS460SDC-3-001	DS550SPE-3-001	



DS550DC



DS650/DS850



DS750PED

**NEW!**

	DS550DC-3	DS650-3	DS650-5	DS650-9	DS650DC-3	DS750PED-3
<b>Input</b>						
Input Range	40-72 Vdc	90-264 Vac	90-264 Vac	90-264 Vac	40-72 Vdc	90-264 Vac
Frequency	DC	47-63 Hz	47-63 Hz	47-63 Hz	DC	47-63 Hz
Efficiency	80% Typ	80% Typ	80% Typ	82% Typ	80% Typ	94% Typ
EMI/RFI	N/A	Class B	Class B	Class B	N/A	Class A
Leakage Current	N/A	1.4 mA @ 240 V	1.4 mA @ 240 V	1.4 mA @ 240 V	N/A	1.75 mA @ 240 V
<b>Outputs</b>						
Output Main	12 V / 45 A	12 V / 52.5 A	24 V / 26.3 A	48 V / 13.1 A	12 V / 52.5 A	12 V / 62.5 A
Output Stand-By	3.3 Vsb / 3 A	3.3 Vsb / 6 A	3.3 Vsb / 6 A	3.3 Vsb / 6 A	3.3 Vsb / 6 A	12 V / 3 A
OCP/OVP/OTP	YES	YES	YES	YES	YES	YES
I <sup>2</sup> C Control	YES	YES	YES	YES	YES	YES
<b>Environmental</b>						
Operating Temp	-10 °C to 50 °C	-10 °C to 50 °C	-10 °C to 50 °C	-10 °C to 50 °C	-10 °C to 50 °C	10 °C to 50 °C
Derating	N/A	50% at 70 °C	50% at 70 °C	50% at 70 °C	50% at 70 °C	N/A
Storage	-40 °C to +85 °C	-40 °C to +85 °C	-40 °C to +85 °C	-40 °C to +85 °C	-40 °C to +85 °C	-40 °C to +70 °C
RoHS Compliant	YES	YES	YES	YES	YES	YES
MTBF	500K Hours	500K Hours	500K Hours	500K Hours	500K Hours	200K Hours
<b>Other</b>						
Size (inch)	1.57 x 3.07 x 11.05	1.57 x 3.20 x 11.00	1.57 x 3.20 x 11.00	1.57 x 3.20 x 11.00	1.57 x 3.20 x 11.00	1.57 x 3.39 x 7.74
Size (mm)	40 x 78 x 280	40 x 81.3 x 279.4	40 x 81.3 x 279.4	40 x 81.3 x 279.4	40 x 81.3 x 279.4	41 x 86.3 x 196.5
Power Density	10.30	11.76	11.76	11.76	11.76	18.23043267
Cubic Inches	53.42	55.44	55.44	55.44	55.44	41.14
Pro-E Files	YES	YES	YES	YES	YES	YES
Thermal Data	YES	YES	YES	YES	YES	YES
PQ Airflow Curves	YES	YES	YES	YES	YES	YES
Warranty	Two Years	Two Years	Two Years	Two Years	Two Years	Two Years
<b>Ordering Codes</b>						
Standard	DS550DC-3/ DS550DC-3-004	DS650-3	DS650-5	DS650-9	DS650DC-3	DS750PED-3
ALT Standby					DS650DC-3-002	
Reverse Air	DS550DC-3-003	DS650-3-007			DS650DC-3-003	DS750PED-3-001
ALT Standby & Reverse Air					DS650DC-3-004	



DS760SL



DS800SL



DS850

	DS760SL-3	DS800SL-3	DS850-3	DS850-5	DS850-9
<b>Input:</b>					
Input Range	90-264 Vac	90-264 Vac	90-264 Vac	90-264 Vac	90-264 Vac
Frequency	47-63 Hz	47-63 Hz	47-63 Hz	47-63 Hz	47-63 Hz
Efficiency	90% Typ	92% Typ GLD	82% Typ	82% Typ	83% Typ
EMI/RFI	Class A	Class B	Class B	Class B	Class B
Leakage Current	0.8 mA @240 V	0.8 mA @240 V	1.4 mA @ 240 V	1.4 mA @ 240 V	1.4 mA @ 240 V
<b>Outputs</b>					
Output Main	12 V / 62.3 A	12 V / 66.7 A	12 V / 70 A	24 V / 35 A	48 V / 17.5 A
Output Stand-By	5.0 Vsb / 3.6 A	5.0 Vsb / 4 A	3.3 Vsb / 6 A	3.3 Vsb / 6 A	3.3 Vsb / 6 A
OCP/OVP/OTP	YES	YES	YES	YES	YES
I <sup>2</sup> C Control	YES	YES	YES	YES	YES
<b>Environmental</b>					
Operating Temp	0 °C to 50 °C	0 °C to 50 °C	-10 °C to 50 °C	-10 °C to 50 °C	-10 °C to 50 °C
Derating	N/A	N/A	50% at 70 °C	50% at 70 °C	50% at 70 °C
Storage	-40 °C to +85 °C	-40 °C to +85 °C	-40 °C to +85 °C	-40 °C to +85 °C	-40 °C to +85 °C
RoHS Compliant	YES	YES	YES	YES	YES
MTBF	300K Hours	500K Hours	500K Hours	500K Hours	500K Hours
<b>Other:</b>					
Size (inch)	1.57 x 2.15 x 12.68	1.57 x 2.15 x 12.68	1.57 x 3.20 x 11.00	1.57 x 3.20 x 11.00	1.57 x 3.20 x 11.00
Size (mm)	40 x 54.5 x 322	40 x 54.5 x 322	40 x 81.3 x 279.4	40 x 81.3 x 279.4	40 x 81.3 x 279.4
Power Density	17.76	18.69	15.38	15.38	15.38
Cubic Inches	42.8	42.8	55.44	55.44	55.44
Pro-E Files	YES	YES	YES	YES	YES
Thermal Data	YES	YES	YES	YES	YES
PQ Airflow Curves	YES	YES	YES	YES	YES
Warranty	Two Years	Two Years	Two Years	Two Years	Two Years
<b>Ordering Codes</b>					
Standard	DS760SL-3	DS800SL-3	DS850-3	DS850-5	DS850-9
ALT Standby	DS760SL-3-002		DS850-3-003		
Reverse Air	DS760SL-3-001	DS800SL-3-001	DS850-3-006		
ALT Standby & Reverse Air	DS760SL-3-003		DS850-3-008		



DS850DC



DS1100PED



DS1200

**NEW!**

	DS850DC-3	DS1050-3	DS1100PED-3	DS1200-3	DS1200DC-3
<b>Input:</b>					
Input Range	40-72 Vdc	90-264 Vac	90-264 Vdc	90-264 Vac	40-72 Vdc
Frequency	DC	47-63 Hz	47-63 Hz	47-63 Hz	DC
Efficiency	80% Typ	92% Typ GLD	94% Typ	90% Typ	91% Typ
EMI/RFI	N/A	Class B	Class A	Class B	N/A
Leakage Current	N/A	1.4 mA @ 240 V	1.75 mA @ 240 V	1.4 mA @ 240 V	N/A
<b>Outputs:</b>					
Output Main	12 V / 70 A	12 V / 85.5 A	12 V / 91.67 A	12 V / 98 A	12 V / 98 A
Output Stand-By	3.3 Vsb / 6 A	3.3 Vsb / 6 A	12 V / 3 A	3.3 Vsb / 6 A	3.3 Vsb / 6 A
OCP/OVP/OTP	YES	YES	YES	YES	YES
I <sup>2</sup> C Control	YES	YES	YES	YES	YES
<b>Environmental</b>					
Operating Temp	-10 °C to 50 °C	-10 °C to 50 °C	10 °C to 50 °C	-10 °C to 50 °C	-10 °C to 50 °C
Derating	50% at 70 °C	50% at 70 °C	N/A	50% at 70 °C	50% at 70 °C
Storage	-40 °C to +85 °C	-40 °C to +85 °C	-40 °C to +70 °C	-40 °C to +85 °C	-40 °C to +85 °C
RoHS Compliant	YES	YES	YES	YES	YES
MTBF	500K Hours	500K Hours	200K Hours	500K Hours	500K Hours
<b>Other</b>					
Size (inch)	1.57 x 3.20 x 11.00	1.57 x 3.20 x 11.00	1.57 x 3.39 x 7.75	1.57 x 3.20 x 11.00	1.57 x 3.20 x 11.00
Size (mm)	40 x 81.3 x 279.4	40 x 81.3 x 279.4	42 x 86.3 x 196.5	40 x 81.3 x 279.4	40 x 81.3 x 279.4
Power Density	15.38	18.95	26.73796791	21.71	21.71
Cubic Inches	55.44	55.44	41.14	55.44	55.44
Pro-E Files	YES	YES	YES	YES	YES
Thermal Data	YES	YES	YES	YES	YES
PQ Airflow Curves	YES	YES	YES	YES	YES
Warranty	Two Years	Two Years	Two Years	Two Years	Two Years
<b>Ordering Codes</b>					
Standard	DS850DC-3	DS1050-3	DS1100PED-3	DS1200-3	DS1200DC-3/ DS1200DC-3-005
ALT Standby	DS850DC-3-003	DS1050-3-002		DS1200-3-002	DS1200DC-3-002
Reverse Air	DS850DC-3-004	DS1050-3-001	DS1100PED-3-001	DS1200-3-003	DS1200DC-3-001
ALT Standby & Reverse Air		DS1050-3-003		DS1200-3-004	





**NEW!**

**NEW!**

**NEW!**

	DS1600SPE-3	DS2000-3	DS2500PE-3	DS2900	DS3000PE-3
<b>Input:</b>					
Input Range	180-264 Vac	90-264 Vac	180-264Vac	180-264 Vac	208-264 Vac
Frequency	47-63 Hz	47-63 Hz	47-63 Hz	47-63 Hz	47-63 Hz
Efficiency	94% Typ	87% Typ	94% Typ	90% Typ	94% Typ
EMI/RFI	Class A	Class B	Class A	Class B	Class A
Leakage Current	1.75 mA @ 240 V	1.4 mA @ 24 0V	0.75 mA @ 240 V	1.4 mA @ 240 V	0.58 mA @ 240 V
<b>Outputs:</b>					
Output Main	12 V / 133.3 A	12 V / 165 A	12 V / 208.3 A	12 V / 240 A	12 V / 250 A
Output Stand-By	12 V / 4.5 A	3.3 Vsb / 9 A	3.3 V / 1 A	3.3 Vsb / 3 A	12 V / 4.5 A
OCP/OVP/OTP	YES	YES	YES	YES	YES
I <sup>2</sup> C Control	YES	YES	YES	YES	YES
<b>Environmental</b>					
Operating Temp	0 °C to 50 °C	-10 °C to 50 °C	10 °C to 50 °C	0 °C to 50 °C	0 °C to 40 °C
Derating	50% at 70 °C	N/A	N/A	N/A	25% at 50 °C
Storage	-40 °C to +85 °C	-40 °C to +85 °C	-40 °C to +60 °C	-40 °C to +85 °C	-40 °C to +85 °C
RoHS Compliant	YES	YES	YES	YES	YES
MTBF	200K Hours	500K Hours	750K Hours	500K Hours	400K Hours
<b>Other</b>					
Size (inch)	1.57 x 3.39 x 7.76	1.57 x 4.2 x 11.6	1.69 x 5.47 x 10.63	3.07 x 4.17 x 8.5	4.15 x 2.78 x 11.12
Size (mm)	43 x 86.3 x 196.5	40 x 106.7 x 295.7	42.9 x 139 x 270	78 x 106 x 217	105.5 x 70.6 x 282.6
Power Density	38.89158969	26.2	25.44011397	26.7	26.26280312
Cubic Inches	41.14	76.5	98.27	108.8	114.23
Pro-E Files	YES	YES	YES	YES	YES
Thermal Data	YES	YES	YES	YES	YES
PQ Airflow Curves	YES	YES	YES	YES	YES
Warranty	Two Years	Two Years	Two Years	Two Years	Two Years
<b>Ordering Codes</b>					
Standard	DS1600SPE-3	DS2000-3	DS2500PE-3	DS2900-3	DS3000PE-3
ALT Standby		DS2000-3-002		DS2900-3-002	
Reverse Air	DS1600SPE-3-001	DS2000-3-001		DS2900-3-001	
ALT Standby & Reverse Air				DS2900-3-003	

# ADN-C Series Single Phase

120-960 Watts

## Special Features

- Slim form factor
- Five year warranty
- High efficiency > 90% typical
- Full power at 60 °C
- PowerBoost technology
- Industrial grade design
  - Metal mounting clip
  - Metal case
- MTBF > 450,000h demonstrated at 40 °C
- Active PFC > 0.92
- Adjustable output
- Overvoltage protection with auto recovery
- Continuous short-circuit and overload protection
- SEMI F47 Sag Immunity
- New visual diagnostic LED
- Three Status LEDs
  - Input, Output, Alarm
- DC OK Relay
- Parallel operation capability
- Screw terminal connections
- RoHS compliant
- No tools required for mounting



## Electrical Specifications

Input	
AC Input range	Nominal: 115-230 Vac 85-264 Vac
DC Input range	90-375 Vdc
Frequency	47-67 Hz, 400 Hz
Efficiency	> 90%
Inrush current	ADN5-24-1PM-C: < 15 A ADN10-24-1PM-C: < 30 A ADN20-24-1PM-C: < 40 A
PFC	Active, better than 0.92

Output	
Nominal voltage	ADN5-24-1PM-C & ADN10-24-1PM-C: 24 Vdc (22.5-28.5 Vdc Adj) ADN20-24-1PM-C: 24 Vdc (24-28 Vdc Adj)
Initial voltage setting	24.5 V ±1%
Hold-up time	> 20 ms at full load (100 Vac Input @ Tamb = +25 °C)
Voltage regulation	< ±2% (combination line, load, time and temperature related changes)
Ripple	ADN5-24-1PM-C & ADN10-24-1PM-C: < 50 mVpp ADN20-24-1PM-C: < 100 mVpp
Back EMF immunity	< 35 Vdc
PowerBoost	1.5x nominal current for 4 seconds
Short-circuit current	1.5x nominal current at near zero volts at short-circuit condition
Parallel operation	Switch selectable single unit or parallel unit operation. Units will not be damaged by parallel operation (regardless of switch position setting)
Output noise suppression	Radiated EMI values below EN61000-6-2
Overvoltage protection	> 30.5 Vdc but < 33 Vdc, auto recovery
Line and load regulation	< 0.5%
Time and temperature drift	< 1%



Power	Voltage	Current	Size L x W x H (mm)	Model Number
<b>120 W</b>	85-264 Vac 90-375 Vdc	5 A	4.85" x 1.97" x 4.37" (123 x 50 x 111)	ADN5-24-1PM-C
<b>240 W</b>	85-264 Vac 90-375 Vdc	10 A	4.85" x 2.36" x 4.37" (123 x 60 x 111)	ADN10-24-1PM-C
<b>480 W</b>	85-264 Vac 90-375 Vdc	20 A	4.85" x 3.42" x 4.96" (123 x 87 x 126)	ADN20-24-1PM-C
<b>960 W</b>	85-264 Vac 90-375 Vdc	40 A	4.81" x 7.09" x 4.85" (122.2 x 180 x 123.3)	ADN40-24-1PM-C

# ADN-C Series 3-Phase

120-960 Watts

NEW!



## Special Features

- Slim form factor
- Five year warranty
- High efficiency > 93% typical
- Full power at 60 °C
- PowerBoost technology
- Industrial grade design – metal cases
- MTBF > 450,000h demonstrated at 40 °C
- Active PFC
- Adjustable output
- Overvoltage protection with auto recovery
- Continuous short-circuit and overload protection
- Three Status LEDs – Input, Output, Alarm
- DC OK Relay
- Parallel operation capability
- Screw terminal connections
- RoHS compliant
- No tools required for mounting

## Electrical Specifications

Input	
Nominal voltage	380-480 Vac
AC Input range	320-540 Vac
DC Input range	450-720 Vdc for ADN20
Frequency	50-60 Hz
Efficiency	93% for ADN20; 94% for ADN40
PFC	Active power factor correction
Two phase input	Derate to 75% and 50% for ADN20 and ADN40 respectively under loss of 1 phase. Units will shut down if thermal threshold is exceeded under this condition
Output	
Nominal voltage	24 V (24.0-28.0 Vdc Adj.)
Hold-up time	> 20 ms for ADN20; > 15 ms for ADN40
Voltage regulation	< ±2% overall
Ripple	< 100 mVpp
PowerBoost	1.5x nominal current for 4 seconds
Peak current	1.5x nominal current for 4 seconds minimum while holding voltage > 20 Vdc
Parallel operation	Single or parallel operation selectable via front switch. For redundant operation use of external diode module is preferred; ADN40 uses active paralleling
Power back immunity	> 35 V
Overvoltage protection	> 30.5 Vdc but < 33 Vdc, auto recovery



Power	Voltage	Current	Size L x W x H (mm)	Model Number
<b>120 W</b>	320-540 Vac 450-760 Vdc	5 A @ 24 Vdc	4.85" x 1.97" x 4.37" (123 x 50 x 111)	ADN5-24-3PM-C
<b>240 W</b>	320-540 Vac 450-760 Vdc	10 A @ 24 Vdc	4.85" x 2.36" x 4.37" (123 x 60 x 111)	ADN10-24-3PM-C
<b>480 W</b>	320-540 Vac 450-760 Vdc	20 A @ 24 Vdc	4.68" x 3.34" x 4.85" (119 x 85 x 123)	ADN20-24-3PM-C
<b>960 W</b>	320-540 Vac	40 A @ 24 Vdc	4.85" x 7.09" x 4.85" (123 x 180 x 123)	ADN40-24-3PM-C



## DC-DC Converters

*Emerson Network Power is widely acknowledged as an industry leader in distributed power applications and produces an exceptionally wide range of DC-DC conversion products.*



# Distributed Power Architecture

Emerson Network Power understands the needs and nuances of developing power systems using Distributed Power Architecture. We know it is your job to create the most efficient, cost-effective, quality system, and deliver it in a timely fashion.

From full-system power to board-level components, high-power isolated front ends to a full line of isolated and non-isolated DC-DC modules, Emerson Network Power is the source for today's power systems.

## Distributed Power Architecture DC-DC Conversion

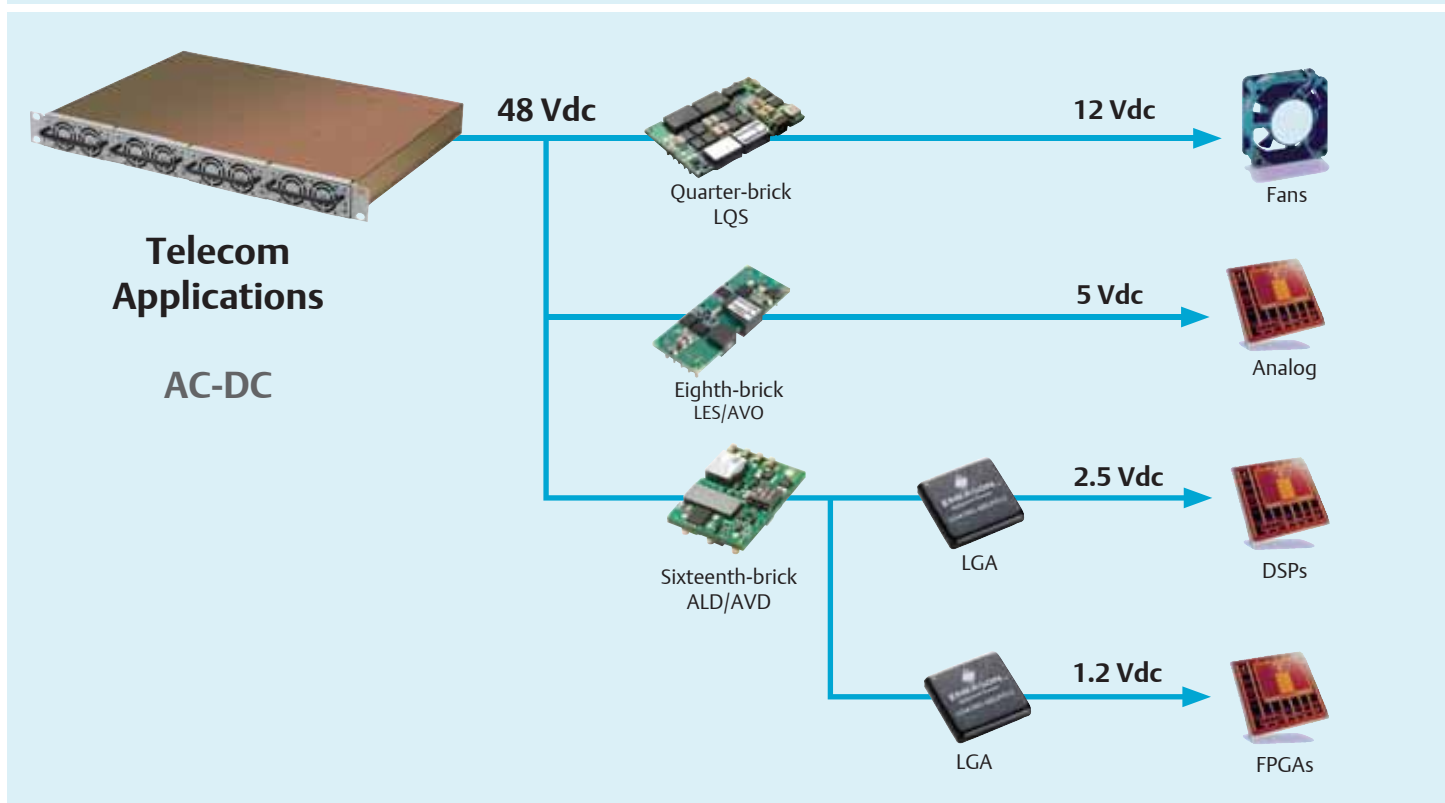
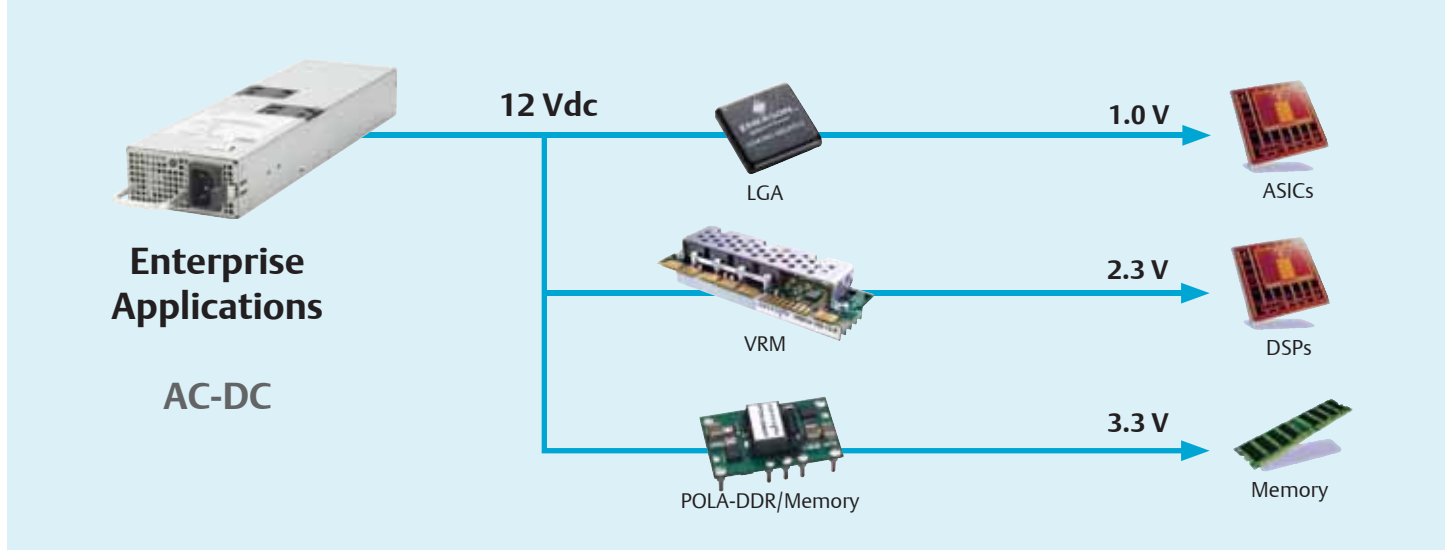



# Sixteenth-Brick



AVD75



ALD25Y48

## Special Features

- Industry leading sixteenth-brick standard package and feature sets
- Scalable offering: 35 W, 50 W, 75 W and 85 W platforms
- Mechanical options for optimum mounting flexibility: Through-hole (default) or surface mount (suffix “-S”) termination; 5 mm (default) or 3.7 mm through-hole pin length option
- Meets basic insulation
- Power densities as high as 146.5 W per cubic inch
- International safety standards approvals – UL, CSA, TÜV

Vout	Iout	Input Voltage	Package L x W x H (mm)	Efficiency	Model Number
<b>1.2 V</b>	<b>Open-frame</b>				
	15 A	48 V (36-75 V)	1.3" x 0.9" x 0.35" (33 x 22.86 x 8.89)	84%	ALD15K48N-L
	25 A	48 V (36-75 V)	1.3" x 0.9" x 0.34" (33 x 22.9 x 8.9)	84%	AVD75-48S1V2-6L
	<b>Baseplate</b>				
	25 A	48 V (36-75 V)	1.3" x 0.9" x 0.5" (33 x 22.9 x 12.7)	84%	AVD75-48S1V2B-6L
<b>1.5 V</b>	<b>Open-frame</b>				
	15 A	48 V (36-75 V)	1.3" x 0.9" x 0.35" (33 x 22.86 x 8.89)	85%	ALD15M48N-L
	25 A	48 V (36-75 V)	1.3" x 0.9" x 0.35" (33 x 22.86 x 8.89)	85%	ALD25M48N-L
<b>1.8 V</b>	<b>Open-frame</b>				
	13 A	48 V (36-75 V)	1.3" x 0.9" x 0.35" (33 x 22.86 x 8.89)	87%	ALD13Y48N-L
	25 A	48 V (36-75 V)	1.3" x 0.9" x 0.35" (33 x 22.86 x 8.89)	88%	ALD25Y48N-L
<b>2.5 V</b>	<b>Open-frame</b>				
	11 A	48 V (36-75 V)	1.3" x 0.9" x 0.35" (33 x 22.86 x 8.89)	89%	ALD11G48N-L
	20 A	48 V (36-75 V)	1.3" x 0.9" x 0.35" (33 x 22.86 x 8.89)	89%	ALD20G48N-L
<b>3.3 V</b>	<b>Open-frame</b>				
	15 A	48 V (36-75 V)	1.3" x 0.9" x 0.37" (33 x 22.9 x 9.5)	91%	AVD50B-48S3V3-6L
	20 A	48 V (36-75 V)	1.3" x 0.9" x 0.41" (33 x 22.9 x 10.5)	92%	AVD75-48S3V3-6L
	25 A	48 V (36-75 V)	1.3" x 0.9" x 0.41" (33 x 22.9 x 10.5)	92%	AVD85-48S3V3-6L
	<b>Baseplate</b>				
	20 A	48 V (36-75 V)	1.3" x 0.9" x 0.5" (33 x 22.9 x 12.7)	92%	AVD75-48S3V3B-6L
	25 A	48 V (36-75 V)	1.3" x 0.9" x 0.5" (33 x 22.9 x 12.7)	92%	AVD85-48S3V3B-6L
<b>5 V</b>	<b>Open-frame</b>				
	7 A	48 V (36-75 V)	1.3" x 0.9" x 0.35" (33 x 22.86 x 8.89)	91%	ALD07A48N-L
	10 A	48 V (36-75 V)	1.3" x 0.9" x 0.37" (33 x 22.9 x 9.5)	92%	AVD50-48S05-6L
	12 A	48 V (36-75 V)	1.3" x 0.9" x 0.35" (33 x 22.86 x 8.89)	91%	ALD12A48N-L
<b>12 V</b>	<b>Open-frame</b>				
	2.75 A	48 V (36-75 V)	1.3" x 0.9" x 0.35" (33 x 22.86 x 8.89)	92%	ALD03B48N-L
	7 A	48 V (36-75 V)	1.3" x 0.9" x 0.34" (33 x 22.9 x 8.9)	92%	AVD85-48S12-6L
	<b>Baseplate</b>				
	7 A	48 V (36-75 V)	1.3" x 0.9" x 0.5" (33 x 22.9 x 12.7)	92%	AVD85-48S12B-6L

# Eighth-Brick

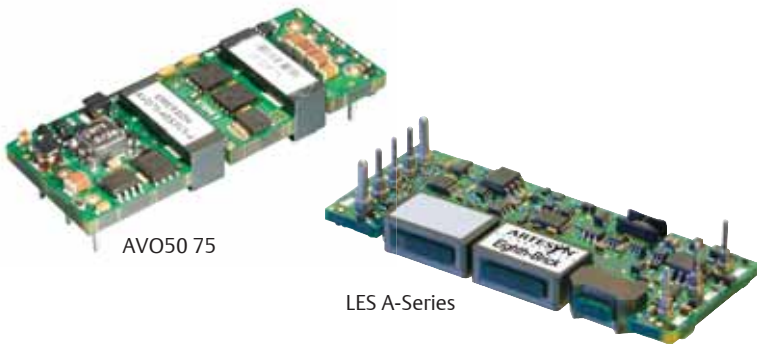

## Special Features

- Industry leading eighth-brick standard package and feature sets
- Scalable output power offering: Low power 80 W series or up to 240 W high power series
- Mechanical options for optimum mounting flexibility: Open-frame (ALO, LES, AVO) or baseplate (AEO or AVO-B) construction; Through-hole (default) or surface mount (suffix “-S”) termination; 5 mm (default) or 3.7 mm through-hole pin length option
- Meets basic insulation
- Power densities as high as 181 W per cubic inch
- Wide operating temperature range
- International safety standards approvals – UL, CSA, TÜV

Vout	Iout	Input Voltage	Package L x W x H (mm)	Efficiency	Model Number
<b>1.0 V</b>	<b>Open-frame</b>				
	25 A	48 V (36-75 V)	2.3" x 0.9" x 0.36" (58.42 x 22.86 x 9.14)	85%	LES25B48-1V0REJ
<b>1.2 V</b>	<b>Open-frame</b>				
	20 A	48 V (36-75 V)	2.3" x 0.9" x 0.34" (57.9 x 22.9 x 8.5)	86%	AVO50-48S1V2-4
	25 A	48 V (36-75 V)	2.3" x 0.9" x 0.34" (57.9 x 22.9 x 8.5)	86%	AVO75-48S1V2-4
	50 A	48 V (36-75 V)	2.3" x 0.9" x 0.34" (58.42 x 22.86 x 8.64)	86%	LES50A48-1V2REJ
	<b>Baseplate</b>				
	50 A	48 V (36-75 V)	2.3" x 0.9" x 0.5" (57.9 x 22.9 x 12.7)	85.5%	AVO100-48S1V2B-6L
<b>1.5 V</b>	<b>Open-frame</b>				
	20 A	48 V (36-75 V)	2.3" x 0.9" x 0.34" (57.9 x 22.9 x 8.5)	88%	AVO50-48S1V5-4
	40 A	48 V (36-75 V)	2.3" x 0.9" x 0.34" (57.9 x 22.9 x 8.5)	89%	AVO100B-48S1V5-6L
	<b>Baseplate</b>				
40 A	48 V (36-75 V)	2.3" x 0.9" x 0.5" (57.9 x 22.9 x 12.7)	89%	AVO100B-48S1V5B-6L	
<b>1.8 V</b>	<b>Open-frame</b>				
	20 A	48 V (36-75 V)	2.3" x 0.9" x 0.34" (57.9 x 22.9 x 8.5)	89%	AVO50-48S1V8-4
	20 A	24 V (18-36 V)	2.3" x 0.9" x 0.34" (58.42 x 22.86 x 8.64)	91%	LES20A24-1V8REJ
	25 A	48 V (36-75 V)	2.3" x 0.9" x 0.34" (57.9 x 22.9 x 8.5)	89%	AVO75-48S1V8-4
	40 A	48 V (36-75 V)	2.3" x 0.9" x 0.34" (57.9 x 22.9 x 8.5)	89.5%	AVO100-48S1V8-6L
	<b>Baseplate</b>				
40 A	48 V (36-75 V)	2.3" x 0.9" x 0.5" (57.9 x 22.9 x 12.7)	89.5%	AVO100-48S1V8B-6L	
<b>2.5 V</b>	<b>Open-frame</b>				
	20 A	48 V (36-75 V)	2.3" x 0.9" x 0.34" (57.9 x 22.9 x 8.5)	90%	AVO50-48S2V5-4
	25 A	48 V (36-75 V)	2.3" x 0.9" x 0.34" (57.9 x 22.9 x 8.5)	90%	AVO75-48S2V5-4
	35 A	48 V (36-75 V)	2.3" x 0.9" x 0.34" (57.9 x 22.9 x 8.5)	91.5%	AVO100-48S2V5-6L
	40 A	48 V (36-75 V)	2.3" x 0.9" x 0.34" (58.42 x 22.86 x 8.64)	91%	LES40A48-2V5REJ
	<b>Baseplate</b>				
35 A	48 V (36-75 V)	2.3" x 0.9" x 0.5" (57.9 x 22.9 x 12.7)	91.5%	AVO100-48S2V5B-6L	
<b>3.3 V</b>	<b>Open-frame</b>				
	15 A	48 V (36-75 V)	2.3" x 0.9" x 0.34" (57.9 x 22.9 x 8.5)	90%	AVO50C-48S3V3-6
	20 A	24 V (18-36 V)	2.3" x 0.9" x 0.34" (58.42 x 22.86 x 8.64)	90%	LES20A24-3V3REJ
	20 A	24V/48 V (19-60 V)	2.3" x 0.9" x 0.32" (58.42 x 22.86 x 8.13)	91%	ALO20F36N-L
	20 A	48 V (36-75 V)	2.3" x 0.9" x 0.34" (57.9 x 22.9 x 8.5)	91%	AVO75-48S3V3-4
	30 A	48 V (36-75 V)	2.3" x 0.9" x 0.34" (57.9 x 22.9 x 8.5)	91%	AVO100B-48S3V3-6L
	<b>Baseplate</b>				
30 A	48 V (36-75 V)	2.3" x 0.9" x 0.4" (58.42 x 22.86 x 10.16)	91%	AVO100C-48S3V3B-4L	

Vout	Iout	Input Voltage	Package L x W x H (mm)	Efficiency	Model Number
<b>5 V</b>	<b>Open-frame</b>				
	10 A	48 V (36-75 V)	2.3" x 0.9" x 0.34" (57.9 x 22.9 x 8.5)	91%	AVO50-48S05-4
	13 A	48 V (36-75 V)	2.3" x 0.9" x 0.36" (58.42 x 22.86 x 9.14)	92%	LES13B48-5V0REJ
	15 A	48 V (36-75 V)	2.3" x 0.9" x 0.34" (57.9 x 22.9 x 8.5)	91%	AVO75-48S05-6
	20 A	48 V (36-75 V)	2.3" x 0.9" x 0.34" (57.9 x 22.9 x 8.5)	92.8%	AVO100-48S05-6L
	<b>Baseplate</b>				
	20 A	48 V (36-75 V)	2.3" x 0.9" x 0.5" (57.9 x 22.9 x 12.7)	92.8%	AVO100-48S05B-6L
<b>12 V</b>	<b>Open-frame</b>				
	4.2 A	48 V (36-75 V)	2.3" x 0.9" x 0.34" (57.9 x 22.9 x 8.5)	91%	AVO50-48S12-6L
	6.3 A	48 V (36-75 V)	2.3" x 0.9" x 0.34" (57.9 x 22.9 x 8.5)	91%	AVO75-48S12P-4
	10 A	48 V (36-75 V)	2.3" x 0.9" x 0.32" (58.42 x 22.86 x 8.13)	92%	ALO10B48N-L
	20 A	48 V (41-75 V)	2.3" x 0.9" x 0.37" (57.9 x 22.9 x 9.5)	94%	AVO240-48S12-6L
	<b>Baseplate</b>				
	4 A	48 V (36-75 V)	2.3" x 0.9" x 0.4" (58.42 x 22.86 x 10.16)	93%	AEO04B48N-L
10 A	48 V (36-75 V)	2.3" x 0.9" x 0.4" (58.42 x 22.86 x 10.16)	92%	AEO10B48N-L	
	20 A	48 V (41-75 V)	2.3" x 0.9" x 0.5" (57.9 x 22.9 x 12.7)	94%	AVO240-48S12B-6L



# Quarter-Brick



## Special Features

- Industry leading quarter-brick standard package and feature sets
- Up to 100 A offering
- Wide operating temperature range
- Meets basic insulation
- Exceptional dynamic response and reactive loading capability
- Monotonic start-up characteristic
- International safety standards approvals – UL, CSA, TÜV

V <sub>out</sub>	I <sub>out</sub>	Input Voltage	Package L x W x H (mm)	Efficiency	Model Number	
1.2 V	<b>Open-frame</b>					
	25 A	48 V (36-75 V)	2.28" x 1.45" x 0.38" (57.9 x 36.8 x 9.6)	86%	AGQ100-48S1V2-4	
	40 A	48 V (36-75 V)	2.28" x 1.45" x 0.39" (57.9 x 36.8 x 9.8)	85%	AGQ200-48S1V2-4L	
	60 A	48 V (36-75 V)	2.28" x 1.45" x 0.39" (57.9 x 36.8 x 9.8)	85%	AGQ300-48S1V2-4L	
	100 A	48 V (36-75 V)	2.3" x 1.45" x 0.34" (58.42 x 36.83 x 8.64)	86%	LQS100A48-1V2REJ	
	<b>Baseplate</b>					
	25 A	48 V (36-75 V)	2.28" x 1.45" x 0.50" (57.9 x 36.8 x 12.7)	86%	AGQ100-48S1V2B-4	
	40 A	48 V (36-75 V)	2.28" x 1.45" x 0.50" (57.9 x 36.8 x 12.7)	85%	AGQ200-48S1V2B-4L	
	60 A	48 V (36-75 V)	2.28" x 1.45" x 0.50" (57.9 x 36.8 x 12.7)	85%	AGQ300-48S1V2B-4L	
	1.5 V	<b>Open-frame</b>				
25 A		48 V (36-75 V)	2.28" x 1.45" x 0.38" (57.9 x 36.8 x 9.6)	87%	AGQ100-48S1V5-4	
40 A		48 V (36-75 V)	2.28" x 1.45" x 0.50" (57.9 x 36.8 x 12.7)	86%	AGQ200-48S1V5-4L	
80 A		48 V (36-75 V)	2.3" x 1.45" x 0.34" (58.42 x 36.83 x 8.64)	89%	LQS80A48-1V5REJ	
100 A		48 V (36-75 V)	2.3" x 1.45" x 0.34" (58.42 x 36.83 x 8.64)	89%	LQS100A48-1V5REJ	
<b>Baseplate</b>						
25 A		48 V (36-75 V)	2.28" x 1.45" x 0.50" (57.9 x 36.8 x 12.7)	87%	AGQ100-48S1V5B-4	
40 A		48 V (36-75 V)	2.28" x 1.45" x 0.50" (57.9 x 36.8 x 12.7)	86%	AGQ200-48S1V5B-4L	
1.8 V		<b>Open-frame</b>				
		25 A	48 V (36-75 V)	2.28" x 1.45" x 0.38" (57.9 x 36.8 x 9.6)	87%	AGQ100-48S1V8-4
	40 A	48 V (36-75 V)	2.28" x 1.45" x 0.39" (57.9 x 36.8 x 9.8)	88%	AGQ200-48S1V8-4L	
	50 A	48 V (36-75 V)	2.3" x 1.45" x 0.34" (57.42 x 36.83 x 8.64)	90%	LQS50A48-1V8REJ	
	80 A	48 V (36-75 V)	2.3" x 1.45" x 0.34" (57.42 x 36.83 x 8.64)	90%	LQS80A48-1V8REJ	
	100 A	48 V (36-75 V)	2.3" x 1.45" x 0.34" (57.42 x 36.83 x 8.64)	90%	LQS100A48-1V8REJ	
	<b>Baseplate</b>					
	25 A	48 V (36-75 V)	2.28" x 1.45" x 0.50" (57.9 x 36.8 x 12.7)	87%	AGQ100-48S1V8B-4	
	40 A	48 V (36-75 V)	2.28" x 1.45" x 0.50" (57.9 x 36.8 x 12.7)	88%	AGQ200-48S1V8B-4L	
	2.5 V	<b>Open-frame</b>				
25 A		48 V (36-75 V)	2.28" x 1.45" x 0.39" (57.9 x 36.8 x 9.8)	88%	AGQ100-48S2V5-4	
40 A		48 V (36-75 V)	2.28" x 1.45" x 0.39" (57.9 x 36.8 x 9.8)	90%	AGQ200B-48S2V5-4L	
50 A		48 V (36-75 V)	2.3" x 1.45" x 0.34" (58.42 x 36.83 x 8.64)	90%	LQS50A48-2V5REJ	
80 A		48 V (36-75 V)	2.3" x 1.45" x 0.34" (58.42 x 36.83 x 8.64)	91%	LQS80A48-2V5REJ	
<b>Baseplate</b>						
25 A		48 V (36-75 V)	2.28" x 1.45" x 0.50" (57.9 x 36.8 x 12.7)	88%	AGQ100-48S2V5B-4	
40 A		48 V (36-75 V)	2.28" x 1.45" x 0.50" (57.9 x 36.8 x 12.7)	90%	AGQ200B-48S2V5B-4L	

Vout	Iout	Input Voltage	Package L x W x H (mm)	Efficiency	Model Number
<b>3.3 V</b>	<b>Open-frame</b>				
	25 A	48 V (36-75 V)	2.28" x 1.45" x 0.38" (57.9 x 36.8 x 9.6)	91%	AGQ100C-48S3V3-6L
	30 A	24 V (18-36 V)	2.3" x 1.45" x 0.34" (58.42 x 36.83 x 8.64)	90%	LQS30A24-3V3REJ
	40 A	48 V (36-75 V)	2.28" x 1.45" x 0.39" (57.9 x 36.8 x 9.8)	91%	AGQ200B-48S3V3-4L
	50 A	48 V (36-75 V)	2.3" x 1.45" x 0.34" (58.42 x 36.83 x 8.64)	91%	LQS50A48-3V3REJ
	60 A	48 V (36-75 V)	2.3" x 1.45" x 0.34" (58.42 x 36.83 x 8.64)	91%	LQS60A48-3V3REJ
	<b>Baseplate</b>				
25 A	48 V (36-75 V)	2.28" x 1.45" x 0.50" (57.9 x 36.8 x 12.7)	91%	AGQ100C-48S3V3B-6L	
40 A	48 V (36-75 V)	2.28" x 1.45" x 0.50" (57.9 x 36.8 x 12.7)	91%	AGQ200B-48S3V3B-4L	
<b>5 V</b>	<b>Open-frame</b>				
	30 A	48 V (18-36 V)	2.28" x 1.45" x 0.39" (57.9 x 36.8 x 9.8)	91%	AGQ150-48S05-4L
	40 A	48 V (36-75 V)	2.3" x 1.45" x 0.34" (58.42 x 36.83 x 8.64)	92%	LQS40A48-5V0REJ
	<b>Baseplate</b>				
30 A	48 V (36-75 V)	2.28" x 1.45" x 0.50" (57.9 x 36.8 x 12.7)	91%	AGQ150-48S05B-4L	
<b>12 V</b>	<b>Open-frame</b>				
	8.33 A	48 V (36-75 V)	2.28" x 1.45" x 0.50" (57.9 x 36.8 x 12.7)	90%	AGQ100-48S12-6L
	20 A	48 V (36-75 V)	2.3" x 1.45" x 0.36" (58.42 x 36.83 x 9.14)	93%	ALQ20B48N-L
	<b>Baseplate</b>				
	8.33 A	48 V (36-75 V)	2.28" x 1.45" x 0.50" (57.9 x 36.8 x 12.7)	90%	AGQ100-48S12B-6L
	20 A	48 V (36-75 V)	2.3" x 1.45" x 0.42" (58.42 x 36.83 x 10.67)	93%	AEQ20B48N-L
33 A	48 V (36-75 V)	2.28" x 1.45" x 0.50" (57.9 x 36.83 x 12.7)	93%	AVQ400-48S12B-6L	





# Half-Brick



AGH100 150



AVE300

## Special Features

- Industry standard half-brick available up to 60A
- Open-frame and baseplate construction
- Highest efficiencies available
- Optimum transient load performance and reactive loading capacity
- Wide operating temperature range
- International safety standards approvals – UL, CSA, TÜV

Vout	Iout	Input Voltage	Package L x W x H (mm)	Efficiency	Model Number
<b>1.2 V</b>	<b>Open-frame</b>				
	60 A	48 V (36-75 V)	2.4" x 2.3" x 0.4" (61 x 57.9 x 9.5)	86%	AVE300-48S1V2-4
	<b>Baseplate</b>				
	60 A	48 V (36-75 V)	2.4" x 2.3" x 0.5" (61 x 57.9 x 12.7)	86%	AVE300-48S1V2B-4
<b>1.5 V</b>	<b>Baseplate</b>				
	60 A	48 V (36-75 V)	2.4" x 2.3" x 0.5" (61 x 57.9 x 12.7)	87%	AVE300-48S1V5B-4
<b>1.8 V</b>	<b>Baseplate</b>				
	60 A	48 V (36-75 V)	2.4" x 2.3" x 0.5" (61 x 57.9 x 12.7)	89%	AVE300-48S1V8B-4
<b>2.5 V</b>	<b>Aluminum Substrate</b>				
	20 A	48 V (36-75 V)	2.4" x 2.3" x 0.5" (61 x 57.9 x 12.7)	86%	AVE100-48S2V5
	<b>Open-frame</b>				
	60 A	48 V (36-75 V)	2.4" x 2.3" x 0.4" (61 x 57.9 x 9.5)	91%	AVE300-48S2V5-4
	<b>Baseplate</b>				
	60 A	48 V (36-75 V)	2.4" x 2.3" x 0.5" (61 x 57.9 x 12.7)	91%	AVE300-48S2V5B-4
<b>3.3 V</b>	<b>Open-frame</b>				
	8 A	48 V (36-75 V)	2.4" x 2.28" x 0.43" (60.96 x 57.91 x 10.92)	90%	EXB30-48S3V3J
	25 A	48 V (36-75 V)	2.4" x 2.3" x 0.4" (61 x 57.9 x 9.5)	91%	AGH100-48S3V3-4L
	30 A	48 V (36-75 V)	2.4" x 2.28" x 0.39" (60.96 X 57.91 X 9.91)	91%	EXB100-48S3V3-RJ
	<b>Aluminum Substrate</b>				
	40 A	48 V (36-75 V)	2.4" x 2.3" x 0.5" (61 x 57.9 x 12.7)	89%	AVE200-48S3V3-4
	<b>Baseplate</b>				
	25 A	48 V (36-75 V)	2.4" x 2.3" x 0.5" (61 x 57.9 x 12.7)	91%	AGH100-48S3V3B-4L
	60 A	48 V (36-75 V)	2.4" x 2.3" x 0.5" (61 x 57.9 x 12.7)	92%	AVE300-48S3V3B-4
<b>5 V</b>	<b>Open-frame</b>				
	30 A	48 V (36-75 V)	2.4" x 2.3" x 0.4" (61 x 57.9 x 9.5)	91%	AGH150-48S05-6
	<b>Baseplate</b>				
	30 A	48 V (36-75 V)	2.4" x 2.3" x 0.5" (61 x 57.9 x 12.7)	91%	AGH150-48S05B-6
<b>12 V</b>	<b>Open-frame</b>				
	20A	48 V (36-75 V)	2.4" x 2.3" x 0.4" (61 x 57.9 x 9.5)	92%	AVE240C-48S12-4L
	30A	48 V (36-75 V)	2.4" x 2.3" x 0.4" (61 x 57.9 x 9.5)	94%	AGH360-48S12-6L
	<b>Baseplate</b>				
	8.33 A	24 V (18-36 V)	2.4" x 2.28" x 0.5" (60.96 x 57.91 x 12.7)	85%	BXB100-24S12FLTJ
	30 A	48 V (36-75 V)	2.4" x 2.3" x 0.5" (61 x 57.9 x 12.7)	94%	AGH360-48S12B-6L
	50 A	48 V (36-75 V)	2.4" x 2.3" x 0.5" (61 x 57.9 x 12.7)	95.5%	AVE600-48S12B-4L

# Half-Brick Dual



EXB30

	Current	Input Voltage	Package L x W x H (mm)	Efficiency	Model Number
<b>3.3/5 V</b>	<b>Open-frame</b>				
	<b>6/6 A</b>	24 V (18-36 V)	2.4" x 2.28" x 0.5" (60.96 x 57.91 x 12.7)	87%	EXB30-24D05-3V3J
	<b>6/6 A</b>	48 V (36-75 V)	2.4" x 2.28" x 0.5" (60.96 x 57.91 x 12.)	88%	EXB30-48D05-3V3J
	<b>7.5/7.5 A</b>	48 V (36-75 V)	2.4" x 2.28" x 0.39" (60.96 x 57.91 x 9.91)	89%	EXB50-48D05-3V3-RJ

# RF Power Bricks



AGF600



RFB300



## Special Features

- Specialized high power bricks for RF applications such as base station power amplifiers
- Offered in 24 V and 48 V input voltages
- Wide output voltage adjustability
- -40 °C to 100 °C baseplate temperature for RFB, RFF and -40 °C to 85 °C for AVE, AGF baseplate temperature with no derating at rated power
- International safety standard approvals – UL, CSA, VDE, CB Report

## Half-Brick

Vout	Iout	Input Voltage	Package L x W x H (mm)	Efficiency	Model Number
<b>7.2-13.2 V</b>	<b>Baseplate</b>				
	<b>25 A</b>	24 V (18-36 V)	2.4" x 2.27" x 0.5" (60.96 x 57.66 x 12.7)	86%	RFB300-24S12-R5Y
	<b>29.2 A</b>	48 V (36-75 V)	2.4" x 2.27" x 0.5" (60.96 x 57.66 x 12.7)	86%	RFB350-48S12-R5J
<b>28 V</b>	<b>Aluminum Board</b>				
	<b>12.5 A</b>	24 V (18-36 V)	2.4" x 2.3" x 0.5" (61 x 57.9 x 12.7)	93%	AVE350-24S28-6L
	<b>12.5 A</b>	48 V (36-75 V)	2.4" x 2.3" x 0.5" (61 x 57.9 x 12.7)	93%	AVE350B-48S28-6
	<b>16 A</b>	48 V (36-75 V)	2.4" x 2.3" x 0.5" (61 x 57.9 x 12.7)	94%	AVE450B-48S28-6L/M

## Full-Brick

Vout	Iout	Input Voltage	Package L x W x H (mm)	Efficiency	Model Number
<b>14-33 V</b>	<b>Aluminum Substrate</b>				
	<b>21.5 A</b>	24 V (18-36 V)	4.6" x 2.4" x 0.5" (116.8 x 61 x 12.7)	93%	AGF600-24S28-6L
	<b>21.5 A</b>	48 V (36-75 V)	4.6" x 2.4" x 0.5" (116.8 x 61 x 12.7)	93.5%	AGF600-48S28-6L
	<b>25 A</b>	48 V (36-75 V)	4.6" x 2.4" x 0.5" (116.8 x 61 x 12.7)	93%	AGF700-48S30-6L

# C-Class – Economy

The 1<sup>st</sup> generation C-Class non-isolated DC–DC converters are designed to provide good efficiency and performance.

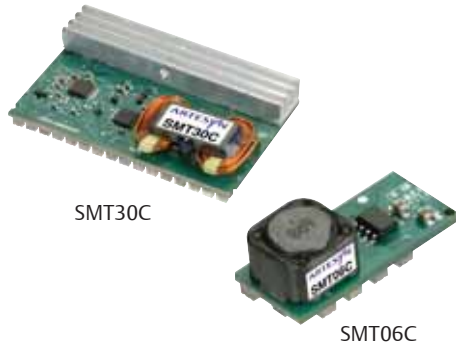

## Special Features

- Input voltage ranges: 4.5-5.5 V or 10.2-13.8 V
- Wide output voltage trim/adjustability: 0.9 to 5 Vdc
- Output current: 6-40 A
- High efficiency up to 92%
- Remote on/off
- Power good
- Parallel operation/current share (SIL30C)
- Remote sense (SIL30C)
- Excellent transient response
- Operating temperature range for SIL20C2 and SIL40C2: 0 °C to 70 °C
- Protection: overcurrent/short-circuit
- Cost-optimized design – industry leading value
- Compact footprint, vertical, horizontal and horizontal SMT options
- International safety standard approvals – UL, CSA, TÜV & CB Report

## General-Purpose C-Class Non-Isolated DC–DC Converters

Output Current	Input Voltage	Output Voltage	Efficiency	Package L x W x H (mm)	Model Number
<b>Single-In-Line, Through-Hole Mounting</b>					
6 A	4.5-5.5 Vdc	0.9-3.3 V	89%	1.2" x 0.45" x 0.61" (30.48 x 11.43 x 15.49)	SIL06C-05SADJ-VJ
6 A	10.2-13.8 Vdc	0.9-5.0 V	91%	1.2" x 0.45" x 0.61" (30.48 x 11.43 x 15.49)	SIL06C-12SADJ-VJ
15 A	4.5-5.5 Vdc	0.9-3.3 V	89%	1.2" x 0.4" x 1.1" (30.48 x 10.16 x 27.94)	SIL15C-05SADJ-VJ
15 A	10.2-13.8 Vdc	0.9-5.0 V	91%	1.2" x 0.4" x 1.1" (30.48 x 10.16 x 27.94)	SIL15C-12SADJ-VJ
25 A	10.2-13.8 Vdc	-4.5-(-5.5 V)	90%	2.4" x 0.52" x 1.25" (60.96 x 13.21 x 31.75)	SIL25C-12SNEG-VJ
30 A	10.2-13.8 Vdc	0.9-5.0 V	91%	2.4" x 0.52" x 1.25" (60.96 x 13.21 x 31.75)	SIL30C-12SADJ-VJ
<b>Surface-Mounting</b>					
6 A	4.5-5.5 Vdc	0.9-3.3 V	89%	1.2" x 0.53" x 0.47" (30.48 x 13.46 x 11.94)	SMT06C-05SADJJ
6 A	10.2-13.8 Vdc	0.9-5.0 V	91%	1.2" x 0.53" x 0.47" (30.48 x 13.46 x 11.94)	SMT06C-12SADJJ
15 A	4.5-5.5 Vdc	0.9-3.3 V	89%	1.2" x 1.1" x 0.46" (30.48 x 27.94 x 11.68)	SMT15C-05SADJJ
15 A	10.2-13.8 Vdc	0.9-5.0 V	91%	1.2" x 1.1" x 0.46" (30.48 x 27.94 x 11.68)	SMT15C-12SADJJ
30 A	10.2-13.8 Vdc	0.9-5.0 V	91%	2.28" x 1.45" x 0.43" (57.91 x 36.83 x 10.92)	SMT30C-12SADJJ

# C-Class – High Density

The 2<sup>nd</sup> generation C-Class non-isolated DC–DC converters are designed to provide good efficiency and performance, a smaller footprint, and integrated input and output capacitors.

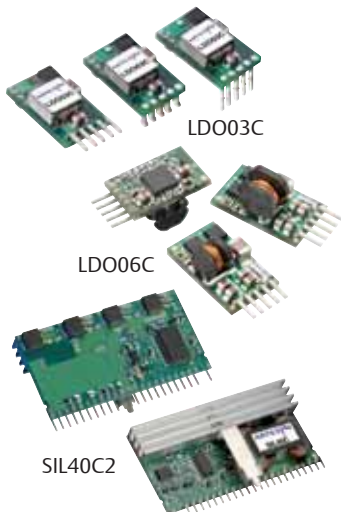

## Special Features

- Wide input voltage ranges: 3-13.8 V or 4.5-13.8 V
- Wide output voltage trim/adjustability: 0.59-5.1 V
- Output current: 3-40 A
- High efficiency up to 94%
- Remote on/off
- Power good
- Remote sense (Sxx20C2, Sxx40C2 and Sxx60C2)
- Excellent transient response
- Current sink capability for termination applications
- Operating temperature range for LDO03, LDO06, LDO10: -40 °C to 85 °C.
- Operating temperature range for SIL/SMT20C2, SIL/SMT40C2 and SIL60C2: 0 °C to 70 °C
- Operating temperature range for SIL/SMT80C2: 0 °C to 85 °C
- Protection: over current/short-circuit
- No added input or output capacitors needed for ripple current capability or stability
- Cost-optimized design – industry leading value
- Compact footprint, vertical, horizontal and horizontal SMT options
- International safety standard approvals – UL, CSA, TÜV & CB Report

General-Purpose C-Class Non-Isolated DC-DC Converters

Output Current	Input Voltage	Output Voltage	Efficiency	Package L x W x H (mm)	Model Number
<b>Single-In-Line, Through-Hole Mounting</b>					
3 A	3.0-13.8 Vdc	0.59-5.1 V	90%	0.37" x 0.21" x 0.61" (9.4 x 5.33 x 15.49)	LDO03C-005W05-VJ
6 A	3.0-13.8 Vdc	0.59-5.1 V	92%	0.41" x 0.37" x 0.65" (10.41 x 9.4 x 16.51)	LDO06C-005W05-VJ
10 A	3.0-13.8 Vdc	0.59-5.1 V	94%	0.41" x 0.45" x 0.65" (10.41 x 11.43 x 16.51)	LDO10C-005W05-VJ
20 A	4.5-13.8 Vdc	0.59-5.1 V	93%	1.2" x 0.46" x 0.61" (30.48 x 11.68 x 15.49)	SIL20C2-00SADJ-VJ
40 A	4.5-13.8 Vdc	0.6-5.0 V	94%	1.2" x 0.43" x 1.1" (30.48 x 10.92 x 27.94)	SIL40C2-00SADJ-VJ
<b>NEW!</b> 60 A	10.8-13.2 Vdc	1.2-4.0V	89%	1.98" x 0.54" x 0.78" (50.29 x 13.72 x 19.81)	SIL60C2-00SADJ-VJD
<b>NEW!</b> 80 A	4.7-13.8 Vdc	0.84-5.0 V	93%	2.4" x 0.7" x 1.25" (60.96 x 17.78 x 31.75)	SIL80C2-00SADJ-VJ
<b>Surface-Mounting</b>					
3 A	3.0-13.8 Vdc	0.59-5.1 V	90%	0.61" x 0.37" x 0.29" (15.49 x 9.4 x 7.37)	LDO03C-005W05-SJ
6 A	3.0-13.8 Vdc	0.59-5.1 V	92%	0.65" x 0.41" x 0.44" (16.51 x 10.41 x 11.18)	LDO06C-005W05-SJ
10 A	3.0-13.8 Vdc	0.59-5.1 V	94%	0.65" x 0.41" x 0.52" (16.51 x 10.41 x 13.21)	LDO10C-005W05-SJ
20 A	4.5-13.8 Vdc	0.59-5.1 V	93%	1.2" x 0.61" x 0.48" (30.48 x 15.49 x 12.19)	SMT20C2-00SADJJ
40 A	4.5-13.8 Vdc	0.6-5.0 V	94%	1.2" x 1.1" x 0.44" (30.48 x 27.94 x 11.18)	SMT40C2-00SADJJ
<b>NEW!</b> 80 A	4.5-13.8 Vdc	0.84-5.1V	88%	2.4" x 1.25" x 0.7" (60.96 x 31.75 x 18.03)	SMT80C2-00SADJ-J

## C-Class – High Density LGA C Series

The latest addition to the C-Class non-isolated DC-DC converter offering packaged in an ultra-compact, low-profile Land Grid Array with current densities up to 225 A/in<sup>3</sup>.



### Special Features

- High density, ultra low profile surface mount module in Land Grid Array (LGA) package
- Available in 4 different output current levels: 3, 6, 10 and 20 Amps
- Wide input voltage range: 3.0-14.0 V
- Adjustable output voltage: 0.59-5.1 V via external resistor
- High efficiency ~92% typical
- Wide ambient operating temperature range: -40 °C to 85 °C
- Input UVLO; Remote On/Off; Output Adjust; Margin; PGood signal, Differential sense
- Current sink capability for voltage termination applications
- Integrated input and output capacitors resulting in minimal external capacitance required for stable operation

### LGA C Series Non-Isolated DC-DC Converters

Output Current	Input Voltage	Output Voltage	Efficiency	Package L x W x H (mm)	Model Number
<b>Surface-Mounting</b>					
3 A	3.0-14 Vdc	0.59-5.1 V	92%	0.65" x 0.65" x 0.129" (16.51 x 16.51 x 3.27)	LGA03C-00SADJJ
6 A	3.0-14 Vdc	0.59-5.1 V	92%	0.65" x 0.65" x 0.129" (16.51 x 16.51 x 3.27)	LGA06C-00SADJJ
10 A	3.0-14 Vdc	0.59-5.1 V	92%	0.65" x 0.65" x 0.129" (16.51 x 16.51 x 3.27)	LGA10C-00SADJJ
20 A	4.5-14 Vdc	0.59-5.1 V	91%	0.65" x 0.65" x 0.210" (16.51 x 16.51 x 5.33)	LGA20C-01SADJJ

Note: Optional heatsink kits are available. Ordering part number is LGA-HTSK-KIT-XXX  
 XXX = Total height of the LGA20C-01SADJJ with heatsink attached: 045 = 0.45"; 048 = 0.48"; 050 = 0.50"

## A Paradigm Shift in Converter Packaging

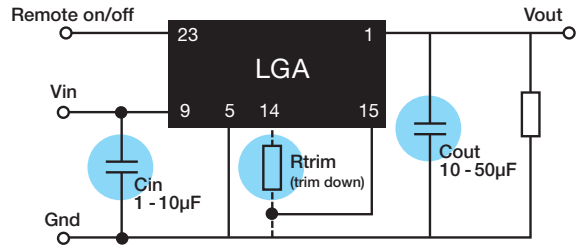
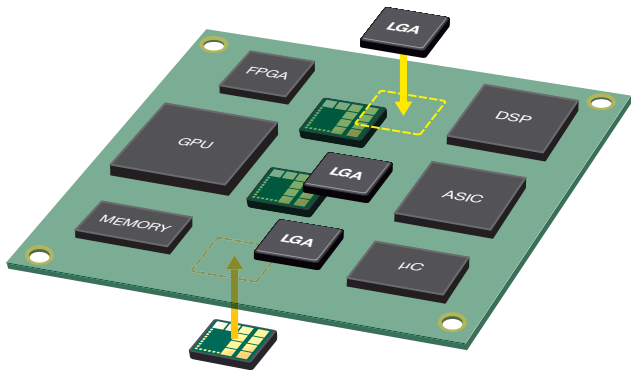

- Compact LGA package - significant improvement in current density, saves board space
- Allows for bilateral thermal management not easily provided by “down” solutions or typical modules (e.g., uniform height for coldplate cooling)
- Scalable solution, one footprint design for 3, 6, 10 and 20 A offering
- Fully operational DC-DC solution with 3 external components

## E-Class – Performance

Efficiencies as high as 96% and current densities up to 140 A/in<sup>3</sup>.

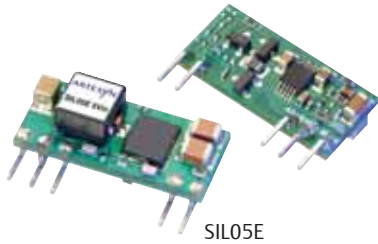

### Special Features

Efficiencies as high as 96% and current densities up to 140 A/in<sup>3</sup>.

- Input voltage ranges: 3-5.5 V, 4.5-5.5 V, 8-14 V, 10-14 V
- Wide output voltage trim ranges: 0.8-3.63 V and 0.75-5.5 V
- Output current: 5-30 A
- Remote on/off
- Remote sense
- Industry standard footprint—vertical and horizontal mounting (low profile SMT/SIP-through-hole)
- Operating temperature range: -40 °C to 85 °C
- Protection: overcurrent/short-circuit
- International safety standard approvals –UL, CSA, TÜV & CB Report

### General-Purpose E-Class Non-Isolated DC–DC Converters

Output Current	Input Voltage	Output Voltage	Efficiency	Package L x W x H (mm)	Model Number
<b>Single-In-Line, Through-hole Mounting</b>					
5 A	3.0-5.5 Vdc	0.75-3.63 V	94%	0.9" x 0.28" x 0.4" (22.86 x 7.11 x 10.16)	SIL05E-05W3V3-VJ
10 A	4.5-5.5 Vdc	0.8-3.63 V	95%	2" x 0.31" x 0.5" (50.8 x 7.87 x 12.7)	SIL10E-05W3V3-VJ
10 A	10-14 Vdc	0.8-3.63 V	94%	2" x 0.31" x 0.5" (50.8 x 7.87 x 12.7)	SIL10E-12W3V3-VJ
15 A	3.0-5.5 Vdc	0.8-3.63 V	94%	2" x 0.31" x 0.5" (50.8 x 7.87 x 12.7)	SIL15E-05W3V3-VJ
15 A	10-14 Vdc	0.8-3.63 V	94%	2" x 0.31" x 0.5" (50.8 x 7.87 x 12.7)	SIL15E-12W3V3-VJ
18 A	3.0-5.5 Vdc	0.75-3.6 V	92%	2" x 0.39" x 0.5" (50.8 x 9.91 x 12.7)	APA18T04-9L
18 A	10-14 Vdc	0.75-3.6 V	92%	2" x 0.39" x 0.5" (50.8 x 9.91 x 12.7)	APA18T12-9L
30 A	8.0-14 Vdc	0.8-3.63 V	93%	2" x 0.31" x 0.5" (50.8 x 7.87 x 12.7)	SIL30E-12W3V3-VJ

For complete product specifications, technical reference notes and available product options, go to [www.Emerson.com/EmbeddedPower](http://www.Emerson.com/EmbeddedPower).



Output Current	Input Voltage	Output Voltage	Efficiency	Package L x W x H (mm)	Model Number
<b>Surface-Mounting</b>					
5 A	3.0-5.5 Vdc	0.75-3.63 V	94%	0.8" x 0.45" x 0.26" (20.32 x 11.43 x 6.6)	SMT05E-05W3V3J
5 A	10-14 Vdc	0.8-3.63 V	91%	0.8" x 0.45" x 0.24" (20.32 x 11.43 x 6.1)	SMT05E-12W3V3J
10 A	3.0-5.5 Vdc	0.8-3.63 V	96%	1.3" x 0.53" x 0.32" (33.02 x 13.46 x 8.13)	SMT10E-05W3V3J
10 A	10-14 Vdc	0.8-3.63 V	94%	1.3" x 0.53" x 0.32" (33.02 x 13.46 x 8.13)	SMT10E-12W3V3J
15 A	3.0-5.5 Vdc	0.8-3.63 V	95%	1.3" x 0.53" x 0.32" (33.02 x 13.46 x 8.13)	SMT15E-05W3V3J
15 A	10-14 Vdc	0.8-3.63 V	94%	1.3" x 0.53" x 0.32" (33.02 x 13.46 x 8.13)	SMT15E-12W3V3J
18 A	3.0-5.5 Vdc	0.75-3.63 V	92%	1.3" x 0.53" x 0.34 (33.02 x 13.46 x 8.64)	APC18T04-9L
18 A	10-14 Vdc	0.75-5.5 V	92%	1.3" x 0.53" x 0.34 (33.02 x 13.46 x 8.64)	APC18T12-9L
30 A	8.0-14 Vdc	0.8-3.63 V	91%	1.3" x 0.53" x 0.32" (33.02 x 13.46 x 8.13)	SMT30E-12W3V3J

## F-Class – Fast Transient Response

Highly integrated non-isolated DC–DC modules, combining transient response up to 300 A/μs. Expressly designed to minimize the number of external capacitors needed.

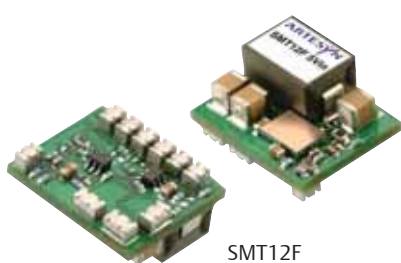

SMT12F

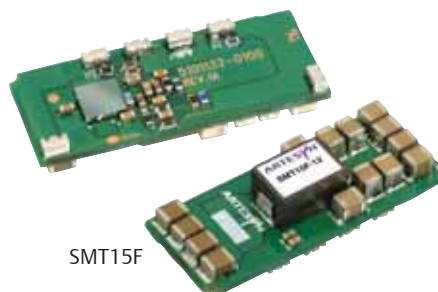

SMT15F

### Special Features

- Input voltage ranges: 3-5.5 Vdc, 10.8-13.2 Vdc
- Wide output voltage trim range: 0.9-3.3 V (SMT12F)
- Output current: 12-15 A
- High efficiency: 95% @ 5 V in 3.3 Vdc output/full load
- Remote on/off
- Differential remote sense
- Power good
- Separate digital inputs for +5% and –5% output voltage margining
- Industry standard surface-mount footprint (SMT15F)
- Current densities in excess of 72 A/in<sup>3</sup>
- Operating temperature range: -40 °C to 85 °C
- Protection: overcurrent/short-circuit (non-latching) and overtemperature
- International safety standard approvals – UL, CSA, TÜV & CB Report

### General-Purpose F-Class Non-Isolated DC–DC Converters

Output Current	Input Voltage	Output Voltage	Efficiency	Package L x W x H (mm)	Model Number
<b>Surface-Mounting</b>					
12 A	3-5.5 Vdc	0.9-3.3 V	95%	0.63" x 0.52" x 0.31" (16 x 13.21 x 7.87)	SMT12F-05W3V3J
15 A	10.8-13.2 Vdc	1.0 V	85%	1.3" x 0.53" x 0.3" (33.02 x 13.46 x 7.62)	SMT15F-12S1V0J
15 A	10.8-13.2 Vdc	1.2 V	86%	1.3" x 0.53" x 0.3" (33.02 x 13.46 x 7.62)	SMT15F-12S1V2J
15 A	10.8-13.2 Vdc	1.5 V	87%	1.3" x 0.53" x 0.3" (33.02 x 13.46 x 7.62)	SMT15F-12S1V5J
15 A	10.8-13.2 Vdc	1.8 V	88%	1.3" x 0.53" x 0.3" (33.02 x 13.46 x 7.62)	SMT15F-12S1V8J

# POLA – General Purpose

Choose POLA modules for multi-sourced and interoperable parts.

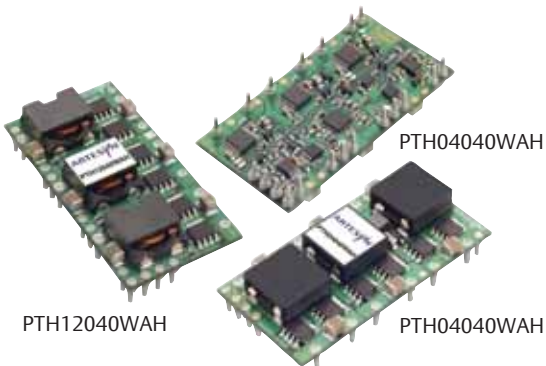

## Special Features

- Input voltage ranges: 2.95-3.65 V, 4.5-5.5 V, 10.8-13.2 V
- Wide output voltage trim and adjustability: 0.8-5.5 V
- Output current: 6-60 A
- High efficiency up to 96%
- Auto-Track™ Sequencing
- Margin up/down controls
- Pre-bias start up capability
- Remote on/off
- Remote sense
- POLA compatible
- True multi-sourcing flexibility (form, fit and function)
- Operating temperature range: -40 °C to 85 °C
- Protection: overcurrent/short-circuit
- Through-hole or surface-mount
- International safety standard approvals – UL, CSA, TÜV & CB Report

## General Purpose POLA Non-Isolated DC–DC Converters

Output Current	Input Voltage	Output Voltage	Efficiency	Package L x W x H (mm)	Model Number*
6 A	2.95-3.65 Vdc	0.8-2.5 V	94%	0.87" x 0.495" x 0.335" (22.01 x 12.57 x 8.51)	PTH03050WAD
6 A	4.5-5.5 Vdc	0.8-3.6 V	95%	0.87" x 0.495" x 0.335" (22.01 x 12.57 x 8.51)	PTH05050WAD
6 A	10.8-13.2 Vdc	1.2-5.5 V	93%	0.87" x 0.495" x 0.335" (22.01 x 12.57 x 8.51)	PTH12050WAD
8 A	2.95-3.65 Vdc	0.8-2.5 V	93%	0.9" x 0.33" x 0.4" (22.86 x 8.38 x 10.16)	PTV03010WAD
8 A	4.5-5.5 Vdc	0.8-3.6 V	95%	0.9" x 0.33" x 0.4" (22.86 x 8.38 x 10.16)	PTV05010WAD
8 A	10.8-3.2 Vdc	1.2-5.5 V	92%	0.9" x 0.33" x 0.4" (22.86 x 8.38 x 10.16)	PTV12010WAD
10 A	2.95-3.65 Vdc	0.8-2.5 V	93%	0.995" x 0.62" x 0.354" (25.27 x 15.75 x 8.99)	PTH03060WAD
10 A	4.5-5.5 Vdc	0.8-3.6 V	94%	0.995" x 0.62" x 0.354" (25.27 x 15.75 x 8.99)	PTH05060WAD
10 A	10.8-3.2 Vdc	1.2-5.5 V	94%	0.995" x 0.62" x 0.354" (25.27 x 15.75 x 8.99)	PTH12060WAD
12 A	10.8-13.2 Vdc	1.2-5.5 V	94%	1.370" x 0.62" x 0.354" (34.80 x 15.75 x 8.99)	PTH12010WAD
15 A	2.95-3.65 Vdc	0.8-2.5 V	93%	1.370" x 0.62" x 0.354" (34.80 x 15.75 x 8.99)	PTH03010WAD
15 A	4.5-5.5 Vdc	0.8-3.6 V	95%	1.370" x 0.62" x 0.354" (34.80 x 15.75 x 8.99)	PTH05010WAD
16 A	10.8-13.2 Vdc	1.2-5.5 V	93%	1.750" x 0.37" x 0.500" (44.45 x 9.4 x 12.7)	PTV12020WAD
18 A	2.95-3.6 Vdc	0.8-2.5 V	95%	1.750" x 0.37" x 0.500" (44.45 x 9.4 x 12.7)	PTV03020WAD
18 A	4.5-5.5 Vdc	0.8-3.6 V	94%	1.750" x 0.37" x 0.500" (44.45 x 9.4 x 12.7)	PTV05020WAD
18 A	10.8-13.2 Vdc	1.2-5.5 V	95%	1.495" x 0.87" x 0.354" (37.97 x 22.01 x 8.99)	PTH12020WAD
22 A	2.95-3.65 Vdc	0.8-2.5 V	95%	1.495" x 0.87" x 0.354" (37.97 x 22.01 x 8.99)	PTH03020WAD
22 A	4.5-5.5 Vdc	0.8-3.6 V	96%	1.495" x 0.87" x 0.354" (37.97 x 22.01 x 8.99)	PTH05020WAD
26 A	10.2-13.8 Vdc	1.2-5.5 V	95%	1.37" x 1.12" x 0.354" (34.80 x 28.45 x 8.99)	PTH12030WAD
30 A	2.95-3.65 Vdc	0.8-2.5 V	93%	1.37" x 1.12" x 0.354" (34.80 x 28.45 x 8.99)	PTH03030WAD
30 A	4.5-5.5 Vdc	0.8-3.6 V	94%	1.37" x 1.12" x 0.354" (34.80 x 28.45 x 8.99)	PTH05030WAD
50 A	8.0-14 Vdc	0.8-5.5 V	96%	2.045" x 1.045" x 0.357" (51.94 x 26.54 x 9.07)	PTH12040WAD
60 A	2.95-2.5 Vdc	0.8-2.5 V	96%	2.045" x 1.045" x 0.357" (51.94 x 26.54 x 9.07)	PTH04040WAD

\*Mounting Option Suffix:

D Horizontal through-hole (RoHS 6/6)

Z Surface-mount solder ball (RoHS 6/6)



## Voltage Regulator Modules (VRM)

Emerson Network Power closely tracks leading semiconductor manufacturers' (Intel®) roadmaps and offer processor power converters designed specifically to match demands.

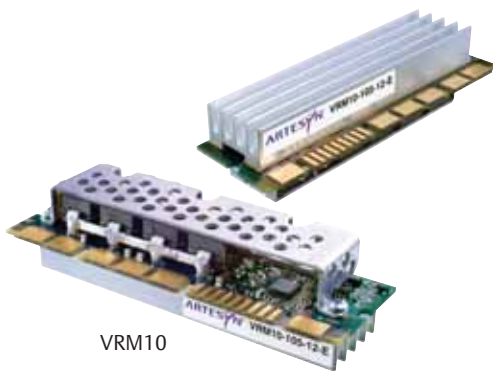

### Special Features

- Voltage regulator modules (VRMs) for Intel
- Input voltage ranges: 10.8-13.2 V, 11-12.6 V and 11-13.2 V
- Output currents up to 105 A
- Output voltage adjustability
- 5-bit and 6-bit VID inputs
- Allows dynamic VID code changes
- High efficiency up to 87%
- Exceptionally fast transient response in excess of 900 A/ $\mu$ s
- Remote on/off
- Differential remote sense
- Low profile to meet 1U applications
- Current sharing – no need for master/slave configurations
- Protection: overcurrent/short-circuit/overvoltage (with on-board fuse)
- International safety standard approvals – VDE

### VRM Processor Non-Isolated DC–DC Converters

VRM Specifications	Output Current	Input Voltage	Output Voltage	Efficiency	Package L x W x H (mm)	Model Number
VRM10.0, VRM10.1	<b>105 A</b>	11-12.6 Vdc	0.8375-1.60 V	84%	3.68" x 1.00" x 1.25" (93.35 x 25.4 x 31.75)	VRM10-105-12-EJ
VRM10.0, VRM10.1	<b>80 A</b>	11-12.6 Vdc	0.8375-1.60 V	85%	3.19" x 0.77" x 1.24" (81.03 x 19.78 x 31.75)	VRM10-80-12-PJ
VRM10.0, VRM10.1	<b>85 A</b>	11-12.6 Vdc	0.8375-1.60 V	85%	3.19" x 0.77" x 1.24" (81.03 x 19.78 x 31.75)	VRM10-85-12-UJ

# On-board AC-DC Distributed Architecture

- High power and high density AC-DC building blocks for quick-turn and modular power solutions
- Alternative power solutions vs. custom development approach
- No fans and high reliability (1M hours MTBF)
- Suitable for harsh temperature conditions (-40 °C startup/-20 °C to 100 °C operating temperature)

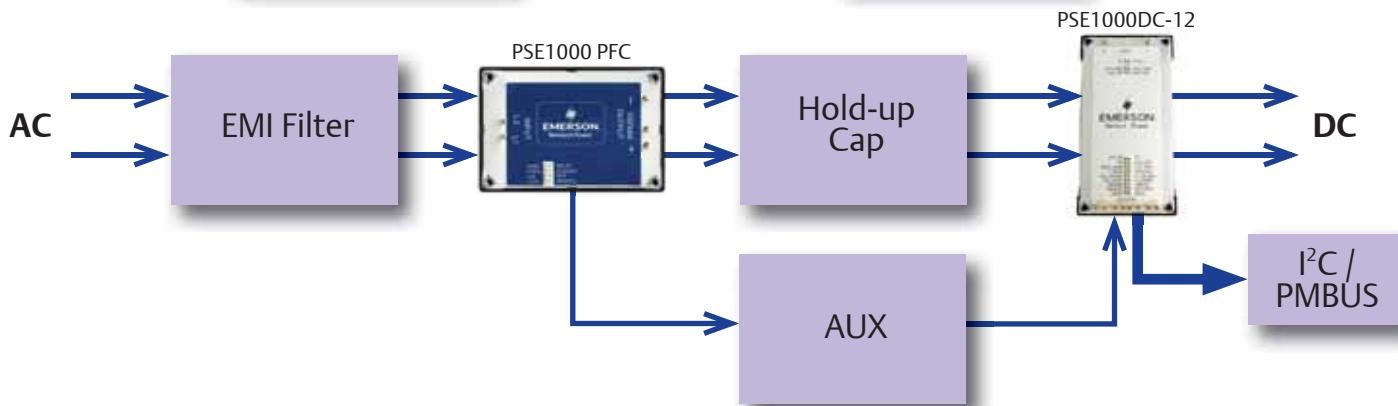
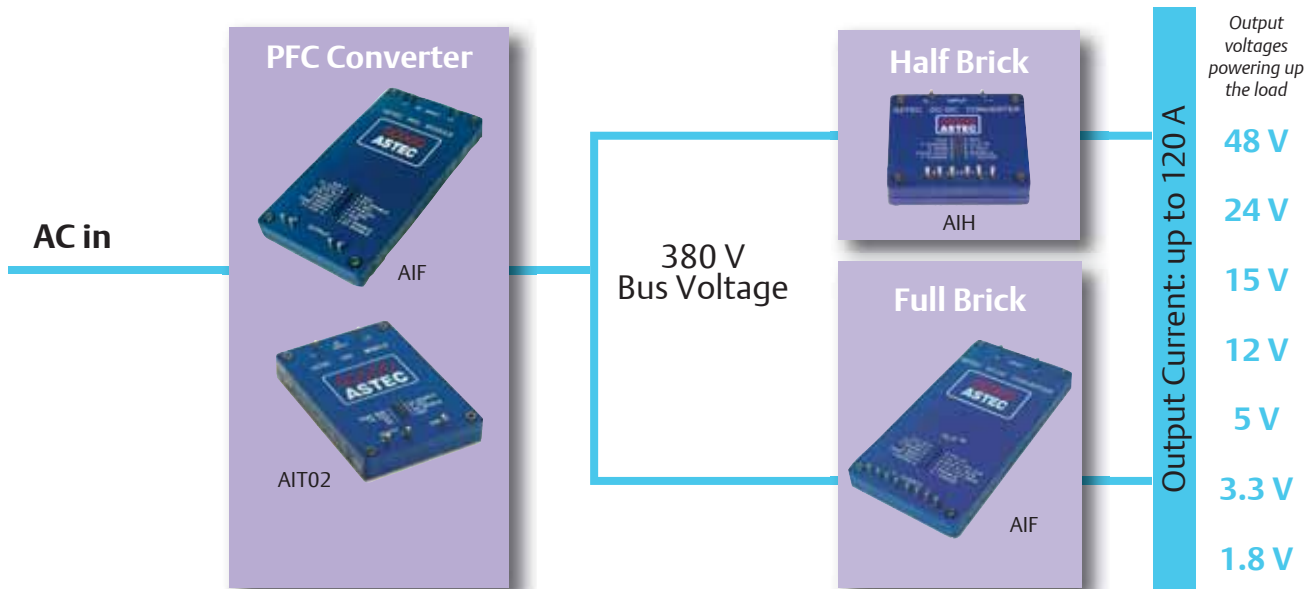

# Power Factor Correction (PFC)



## Special Features

- 1600 W/720 W/75 W
- Unity power factor
- Universal input and frequency range
- Positive and negative enable
- Paralleling with current share
- IEC 1000-3.2 compliance
- 100 °C baseplate
- Clock synch (in/out)
- Current monitoring
- Vout adjust
- On/off enable
- Remote sense
- 95% efficiency
- Fast transient response

Vout	Iout	Input Voltage	Package L x W x H (mm)	Efficiency	Model Number
<b>PFC Module - Baseplate</b>					
380 V	4.2 A	85-264 Vac	4.6" x 2.4" x 0.5" (116.84 x 60.96 x 12.7)	95%	AIF04ZPFC-01L
380 V	4.2 A	85-264 Vac	4.6" x 2.4" x 0.5" (116.84 x 60.96 x 12.7)	95%	AIF04ZPFC-02L
393 V	0.25 A	100-122 Vac	2.3" x 1.45" x 0.5" (58.42 x 36.83 x 12.7)	90%	AIQ00ZPFC-01NL
393 V	2.08 A	85-264 Vac	3.5" x 2.4" x 0.5" (88.9 x 60.96 x 12.7)	93%	AIT02ZPFC-01NL
393 V	0.35 A	100-122 Vac	3.5" x 2.4" x 0.5" (88.9 x 60.96 x 12.7)	91%	AIT00ZPFC-01NL
<b>NEW!</b> 390 V	2.56 A	90-264 Vac	3.5" x 2.4" x 1" (88.9 x 61 x 25.8)	94%	PSE1000PFC*

\*85°C temperature

# High Power 300 Vin

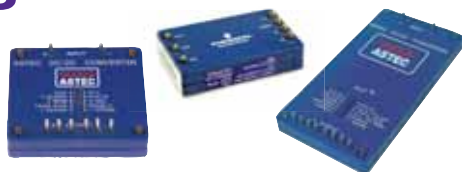

300 V input 65-600 W output

## Special Features

- 300 V input (250-420 V PFC-ready)
- 2nd generation product
- Standard through-hole termination
- Power density >100 W/in<sup>3</sup>
- 100 °C max baseplate operating temperature
- Embedded controls on secondary side (Full- and Half-brick):
  - Temp monitor
  - Current sharing
  - Power good signal
  - Current limit & OVP adjust

	Vout	Iout	Input Voltage	Package L x W x H (mm)	Efficiency	Model Number
<b>AIF 300 Vin</b>	<b>Full-Brick – Baseplate</b>					
	1.8 V	120 A	300 V (250-420 V)	4.6" x 2.4" x 0.5" (116.84 x 60.96 x 12.7)	80%	AIF120Y300-L
	3.3 V	120 A	300 V (250-420 V)	4.6" x 2.4" x 0.5" (116.84 x 60.96 x 12.7)	87%	AIF120F300-L
	5 V	80 A	300 V (250-420 V)	4.6" x 2.4" x 0.5" (116.84 x 60.96 x 12.7)	90%	AIF80A300-L
	12 V	50 A	300 V (250-420 V)	4.6" x 2.4" x 0.5" (116.84 x 60.96 x 12.7)	90%	AIF50B300-L
	15 V	40 A	300 V (250-420 V)	4.6" x 2.4" x 0.5" (116.84 x 60.96 x 12.7)	90%	AIF40C300-L
	24 V	25 A	300 V (250-420 V)	4.6" x 2.4" x 0.5" (116.84 x 60.96 x 12.7)	90%	AIF25H300-L
	48 V	12 A	300 V (250-420 V)	4.6" x 2.4" x 0.5" (116.84 x 60.96 x 12.7)	91%	AIF12W300-L
<b>PSE1000DC</b>	<b>Full-Brick – Baseplate</b>					
12 V	83 A	370-390 V	4.6" x 2.4" x 1" (116.8 x 61 x 25.5)		PSE1000DC-12*	
<b>AIT 300 Vin</b>	<b>Three-Quarter-Brick – Baseplate</b>					
	28 V/3.3 V	3.9A/4.5A	390 V (375-410 V)	3.6" x 2.4" x 0.5" (91.44 x 60.96 x 12.7)	87%	AIT04RF300-L
<b>AIH 300 Vin</b>	<b>Half-Brick – Baseplate</b>					
	1.8 V	50 A	300 V (250-420 V)	2.3" x 2.4" x 0.5" (58.42 x 60.96 x 12.7)	80%	AIH50Y300-L
	3.3 V	50 A	300 V (250-420 V)	2.3" x 2.4" x 0.5" (58.42 x 60.96 x 12.7)	85%	AIH50F300-L
	5 V	40 A	300 V (250-420 V)	2.3" x 2.4" x 0.5" (58.42 x 60.96 x 12.7)	88%	AIH40A300-L
	12 V	20 A	300 V (250-420 V)	2.3" x 2.4" x 0.5" (58.42 x 60.96 x 12.7)	90%	AIH20B300-L
	15 V	16 A	300 V (250-420 V)	2.3" x 2.4" x 0.5" (58.42 x 60.96 x 12.7)	90%	AIH16C300-L
<b>AIQ 300 Vin</b>	<b>Quarter-Brick – Baseplate</b>					
	28 V	2.32 A	300 V (250-420 V)	2.3" x 1.45" x 0.5" (58.42 x 36.83 x 12.7)	89%	AIQ02R300L

\* 85°C temperature

For complete product specifications, technical reference notes and available product options, go to [www.Emerson.com/EmbeddedPower](http://www.Emerson.com/EmbeddedPower).



# Low Power Isolated DC-DC Product



## Special Features

- Input voltages 9-36 V, 18-36 V, 18-75 V and 36-75 V
- Single and dual outputs
- Power 6-30 W
- Regulated outputs
- Operating temperature -40 °C to 71 °C (ambient)
- Overcurrent protection
- 1500 Vdc isolation
- CE Mark Safety (UL Pending)

	Input Voltage	Output Voltage	Package L x W x H (mm)	I/O Isolation	Efficiency	Model Number
<b>6 W</b>	<b>Enclosed</b>					
	9-36 V	12 V @ 0.5 A	DIP 1.25" x 0.8" x 0.4" (31.75 x 20.32 x 10.16)	1500 Vdc	82%	ASA00B18-L
	9-36 V	15 V @ 0.4 A	DIP 1.25" x 0.8" x 0.4" (31.75 x 20.32 x 10.16)	1500 Vdc	83%	ASA00C18-L
	9-36 V	5 V @ 1 A	DIP 1.25" x 0.8" x 0.4" (31.75 x 20.32 x 10.16)	1500 Vdc	81%	ASA01 A18-L
	9-36 V	3.3 V @ 1.2 A	DIP 1.25" x 0.8" x 0.4" (31.75 x 20.32 x 10.16)	1500 Vdc	78%	ASA01F18-L
	9-36 V	5 V @ ±0.5 A	DIP 1.25" x 0.8" x 0.4" (31.75 x 20.32 x 10.16)	1500 Vdc	81%	ASA00 AA18-L
	9-36 V	12 V @ ±0.25 A	DIP 1.25" x 0.8" x 0.4" (31.75 x 20.32 x 10.16)	1500 Vdc	82%	ASA00BB18-L
	9-36 V	15 V @ ±0.2 A	DIP 1.25" x 0.8" x 0.4" (31.75 x 20.32 x 10.16)	1500 Vdc	83%	ASA00CC18-L
	18-75 V	12 V @ 0.5 A	DIP 1.25" x 0.8" x 0.4" (31.75 x 20.32 x 10.16)	1500 Vdc	82%	ASA00B36-L
	18-75 V	15 V @ 0.4 A	DIP 1.25" x 0.8" x 0.4" (31.75 x 20.32 x 10.16)	1500 Vdc	83%	ASA00C36-L
	18-75 V	5 V @ 1 A	DIP 1.25" x 0.8" x 0.4" (31.75 x 20.32 x 10.16)	1500 Vdc	81%	ASA01 A36-L
	18-75 V	3.3 V @ 1.2 A	DIP 1.25" x 0.8" x 0.4" (31.75 x 20.32 x 10.16)	1500 Vdc	78%	ASA01F36-L
	18-75 V	5 V @ ±0.5 A	DIP 1.25" x 0.8" x 0.4" (31.75 x 20.32 x 10.16)	1500 Vdc	81%	ASA00AA36-L
	18-75 V	12 V @ ±0.25 A	DIP 1.25" x 0.8" x 0.4" (31.75 x 20.32 x 10.16)	1500 Vdc	82%	ASA00BB36-L
18-75 V	15 V @ ±0.2 A	DIP 1.25" x 0.8" x 0.4" (31.75 x 20.32 x 10.16)	1500 Vdc	83%	ASA00CC36-L	
<b>10 W</b>	<b>Enclosed</b>					
	18-36 V	12 V @ 0.835 A	DIP 1.25" x 0.8" x 0.4" (31.75 x 20.32 x 10.16)	1500 Vdc	83%	ASA00B24-L
	18-36 V	5 V @ 2 A	DIP 1.25" x 0.8" x 0.4" (31.75 x 20.32 x 10.16)	1500 Vdc	82%	ASA02 A24-L
	18-36 V	3.3 V @ 3 A	DIP 1.25" x 0.8" x 0.4" (31.75 x 20.32 x 10.16)	1500 Vdc	79%	ASA03F24-L
	18-36 V	2.5 V @ 3 A	DIP 1.25" x 0.8" x 0.4" (31.75 x 20.32 x 10.16)	1500 Vdc	77%	ASA03G24-L
	36-75 V	12 V @ 0.835 A	DIP 1.25" x 0.8" x 0.4" (31.75 x 20.32 x 10.16)	1500 Vdc	83%	ASA00B48-L
	36-75 V	5 V @ 2 A	DIP 1.25" x 0.8" x 0.4" (31.75 x 20.32 x 10.16)	1500 Vdc	82%	ASA02 A48-L
	36-75 V	3.3 V @ 3 A	DIP 1.25" x 0.8" x 0.4" (31.75 x 20.32 x 10.16)	1500 Vdc	79%	ASA03F48-L
36-75 V	2.5 V @ 3 A	DIP 1.25" x 0.8" x 0.4" (31.75 x 20.32 x 10.16)	1500 Vdc	87%	ASA03G48-L	
<b>15 W</b>	<b>Enclosed</b>					
	9-36 V	12 V @ 1.25 A	1" x 2" x 0.44" (25.4 x 50.8 x 11.30)	1500 Vdc	84%	AEE01B18-L
	9-36 V	15 V @ 1 A	1" x 2" x 0.44" (25.4 x 50.8 x 11.30)	1500 Vdc	84%	AEE01C18-L
	9-36 V	3.3 V @ 4 A	1" x 2" x 0.44" (25.4 x 50.8 x 11.30)	1500 Vdc	80%	AEE04F18-L
	9-36 V	5 V @ 3 A	1" x 2" x 0.44" (25.4 x 50.8 x 11.30)	1500 Vdc	84%	AEE03 A18-L
	9-36 V	12 V @ ±0.625 A	1" x 2" x 0.44" (25.4 x 50.8 x 11.30)	1500 Vdc	83%	AEE00BB18-L
	9-36 V	15 V @ ±0.5 A	1" x 2" x 0.44" (25.4 x 50.8 x 11.30)	1500 Vdc	83%	AEE00CC18-L
	9-36 V	5 V @ ±1.5 A	1" x 2" x 0.44" (25.4 x 50.8 x 11.30)	1500 Vdc	79%	AEE01 AA18-L
	18-75 V	12 V @ 1.25 A	1" x 2" x 0.44" (25.4 x 50.8 x 11.30)	1500 Vdc	84%	AEE01B36-L
	18-75 V	15 V @ 1 A	1" x 2" x 0.44" (25.4 x 50.8 x 11.30)	1500 Vdc	84%	AEE01C36-L
	18-75 V	3.3 V @ 4 A	1" x 2" x 0.44" (25.4 x 50.8 x 11.30)	1500 Vdc	80%	AEE04F36-L
	18-75 V	5 V @ 3 A	1" x 2" x 0.44" (25.4 x 50.8 x 11.30)	1500 Vdc	84%	AEE03 A36-L
	18-75 V	12 V @ ±0.625 A	1" x 2" x 0.44" (25.4 x 50.8 x 11.30)	1500 Vdc	83%	AEE00BB36-L
	18-75 V	15 V @ ±0.5 A	1" x 2" x 0.44" (25.4 x 50.8 x 11.30)	1500 Vdc	83%	AEE00CC36-L
18-75 V	5 V @ ±1.5 A	1" x 2" x 0.44" (25.4 x 50.8 x 11.30)	1500 Vdc	79%	AEE01 AA36-L	

	Input Voltage	Output Voltage	Package L x W x H (mm)	I/O Isolation	Efficiency	Model Number
<b>20 W</b>	<b>Enclosed</b>					
	9-36 V	2.5 V @ 6 A	1.6" x 2" x 0.48" (40.6 x 50.8 x 12.19)	1500 Vdc	79%	AET06G18-L
	9-36 V	3.3 V @ 6 A	1.6" x 2" x 0.48" (40.6 x 50.8 x 12.19)	1500 Vdc	83%	AET06F18-L
	9-36 V	5 V @ 4 A	1.6" x 2" x 0.48" (40.6 x 50.8 x 12.19)	1500 Vdc	84%	AET04A18-L
	9-36 V	12 V @ 1.67 A	1.6" x 2" x 0.48" (40.6 x 50.8 x 12.19)	1500 Vdc	85%	AET01B18-L
	9-36 V	15 V @ 1.33 A	1.6" x 2" x 0.48" (40.6 x 50.8 x 12.19)	1500 Vdc	85%	AET01C18-L
	9-36 V	5 V @ ±2 A	1.6" x 2" x 0.48" (40.6 x 50.8 x 12.19)	1500 Vdc	84%	AET02AA18-L
	9-36 V	12 V @ ±0.835 A	1.6" x 2" x 0.48" (40.6 x 50.8 x 12.19)	1500 Vdc	85%	AET00BB18-L
	9-36 V	15 V @ ±0.665 A	1.6" x 2" x 0.48" (40.6 x 50.8 x 12.19)	1500 Vdc	85%	AET00CC18-L
	18-75 V	2.5 V @ 6 A	1.6" x 2" x 0.48" (40.6 x 50.8 x 12.19)	1500 Vdc	79%	AET06G36-L
	18-75 V	3.3 V @ 6 A	1.6" x 2" x 0.48" (40.6 x 50.8 x 12.19)	1500 Vdc	83%	AET06F36-L
	18-75 V	5 V @ 4 A	1.6" x 2" x 0.48" (40.6 x 50.8 x 12.19)	1500 Vdc	84%	AET04A36-L
	18-75 V	12 V @ 1.67 A	1.6" x 2" x 0.48" (40.6 x 50.8 x 12.19)	1500 Vdc	85%	AET01B36-L
	18-75 V	15 V @ 1.33 A	1.6" x 2" x 0.48" (40.6 x 50.8 x 12.19)	1500 Vdc	85%	AET01C36-L
	18-75 V	5 V @ ±2 A	1.6" x 2" x 0.48" (40.6 x 50.8 x 12.19)	1500 Vdc	84%	AET02AA36-L
	18-75 V	12 V @ ±0.835 A	1.6" x 2" x 0.48" (40.6 x 50.8 x 12.19)	1500 Vdc	85%	AET00BB36-L
	18-75 V	15 V @ ±0.665 A	1.6" x 2" x 0.48" (40.6 x 50.8 x 12.19)	1500 Vdc	85%	AET00CC36-L
<b>30 W</b>	<b>Enclosed</b>					
	9-36 V	2.5 V @ 8 A	1.6" x 2" x 0.48" (40.6 x 50.8 x 12.19)	1500 Vdc	79%	AET08G18-L
	9-36 V	3.3 V @ 7 A	1.6" x 2" x 0.48" (40.6 x 50.8 x 12.19)	1500 Vdc	82%	AET07F18-L
	9-36 V	5 V @ 6 A	1.6" x 2" x 0.48" (40.6 x 50.8 x 12.19)	1500 Vdc	84%	AET06A18-L
	9-36 V	12 V @ 2.5 A	1.6" x 2" x 0.48" (40.6 x 50.8 x 12.19)	1500 Vdc	85%	AET02B18-L
	9-36 V	15 V @ 2 A	1.6" x 2" x 0.48" (40.6 x 50.8 x 12.19)	1500 Vdc	85%	AET02C18-L
	9-36 V	12 V @ ±1.25 A	1.6" x 2" x 0.48" (40.6 x 50.8 x 12.19)	1500 Vdc	85%	AET01BB18-L
	9-36 V	15 V @ ±1 A	1.6" x 2" x 0.48" (40.6 x 50.8 x 12.19)	1500 Vdc	85%	AET01CC18-L
	18-75 V	2.5 V @ 8 A	1.6" x 2" x 0.48" (40.6 x 50.8 x 12.19)	1500 Vdc	79%	AET08G36-L
	18-75 V	3.3 V @ 7 A	1.6" x 2" x 0.48" (40.6 x 50.8 x 12.19)	1500 Vdc	82%	AET07F36-L
	18-75 V	5 V @ 6 A	1.6" x 2" x 0.48" (40.6 x 50.8 x 12.19)	1500 Vdc	84%	AET06A36-L
	18-75 V	12 V @ 2.5 A	1.6" x 2" x 0.48" (40.6 x 50.8 x 12.19)	1500 Vdc	85%	AET02B36-L
	18-75 V	15 V @ 2 A	1.6" x 2" x 0.48" (40.6 x 50.8 x 12.19)	1500 Vdc	85%	AET02C36-L
	18-75 V	12 V @ ±1.25 A	1.6" x 2" x 0.48" (40.6 x 50.8 x 12.19)	1500 Vdc	85%	AET01BB36-L
	18-75 V	15 V @ ±1 A	1.6" x 2" x 0.48" (40.6 x 50.8 x 12.19)	1500 Vdc	85%	AET01CC36-L

## DC-DC Converter for Railway Application

	Input Voltage V (range)	Output Voltage	Output Current (mA)	Package L x W x H (mm)	I/O Isolation	Efficiency	Model Number
<b>50 W</b>	72 (43 - 101)	5 V	10000	2.28" x 1.45" x 0.5" (57.9 x 36.8 x 12.7)	3000 Vac rms	90%	ERM10A72
	72 (43 - 101)	12 V	4170	2.28" x 1.45" x 0.5" (57.9 x 36.8 x 12.7)	3000 Vac rms	92%	ERM04B72
	72 (43 - 101)	15 V	3330	2.28" x 1.45" x 0.5" (57.9 x 36.8 x 12.7)	3000 Vac rms	92%	ERM03C72
	72 (43 - 101)	24 V	2080	2.28" x 1.45" x 0.5" (57.9 x 36.8 x 12.7)	3000 Vac rms	91%	ERM02H72
	110 (66 - 160)	5 V	10000	2.28" x 1.45" x 0.5" (57.9 x 36.8 x 12.7)	3000 Vac rms	90%	ERM10A110
	110 (66 - 160)	12 V	4170	2.28" x 1.45" x 0.5" (57.9 x 36.8 x 12.7)	3000 Vac rms	91%	ERM04B110
	110 (66 - 160)	15 V	3330	2.28" x 1.45" x 0.5" (57.9 x 36.8 x 12.7)	3000 Vac rms	92%	ERM03C110
	110 (66 - 160)	24 V	2080	2.28" x 1.45" x 0.5" (57.9 x 36.8 x 12.7)	3000 Vac rms	91%	ERM02H110
<b>75 W</b>	72 (43 - 101)	5 V	15000	2.28" x 1.45" x 0.5" (57.9 x 36.8 x 12.7)	3000 Vac rms	89%	ERM15A72
	72 (43 - 101)	12 V	6250	2.28" x 1.45" x 0.5" (57.9 x 36.8 x 12.7)	3000 Vac rms	92%	ERM06B72
	72 (43 - 101)	15 V	5000	2.28" x 1.45" x 0.5" (57.9 x 36.8 x 12.7)	3000 Vac rms	92%	ERM05C72
	72 (43 - 101)	24 V	3125	2.28" x 1.45" x 0.5" (57.9 x 36.8 x 12.7)	3000 Vac rms	91%	ERM03H72
	110 (66 - 160)	5 V	15000	2.28" x 1.45" x 0.5" (57.9 x 36.8 x 12.7)	3000 Vac rms	89%	ERM15A110
	110 (66 - 160)	12 V	6250	2.28" x 1.45" x 0.5" (57.9 x 36.8 x 12.7)	3000 Vac rms	91%	ERM06B110
	110 (66 - 160)	15 V	5000	2.28" x 1.45" x 0.5" (57.9 x 36.8 x 12.7)	3000 Vac rms	91%	ERM05C110
	110 (66 - 160)	24 V	3125	2.28" x 1.45" x 0.5" (57.9 x 36.8 x 12.7)	3000 Vac rms	90%	ERM03H110



# Rapid Modification & Value-Added Solutions

## Why use a Modified Standard Power Supply?

Time-to-market, reliability and costs have the greatest impact on your ROI. Fully custom solutions can delay your time-to-market and undermine your competitive advantage. So why pay custom development costs when Emerson can deliver a modified standard power supply sample the way you want it, delivered in days at a standard price.

## Emerson has you Covered!

**No matter what type of power supply you need, Emerson has you covered!**

While Emerson Network Power offers a broad range of standard products that address the needs of many industries, there are occasions when a standard product does not address all your application requirements. Also, a custom solution does not always make economic sense, especially in terms of your schedule needs. This is where the knowledge and expertise of Emerson Network Power really pays dividends. By using proven standard platforms as building blocks, we can develop cost-effective turnkey power solutions that meet your exact needs.

- Sample lead time varies with complexity.

## Modified Advantage

**What you will get from Emerson's modified power supplies:**

- Broad portfolio of power supplies to leverage from
- Quick time to market vs. custom solutions
- Low risk - using proven reliable platforms as building blocks
- Cost effective (Lower development cost)
- Quality, high reliability products

## Rapid Modification

*Simple to Complex Modifications  
Initial Samples Can be Available  
in Days!*



## Value-Add & Changes Made

- Modified output termination from single to 3-way contact
- AC\_OK and POK Logic and timing signal changes via firmware
- Custom enclosure & accessories
- Ruggedization for shock & vibration
- Firmware changes for heavy peak loading startup; and load adaptive fan speed.



## Capabilities

*Exact specification you require,  
that's within your budget*



### Electrical Parameters

- Factory Vout Preset
- Low Noise
- Power & Efficiency Upgrades
- Hot Swap Control
- Inrush Current Control
- Integrated PDU Assemblies
- Compliance to Industry Standards



### Connectivity

- Cable Wire Assemblies
- Connector Changes
- Busbar Design
- Overmoulding
- Interposer Boards



### Packaging

- Conformal Coating
- Custom Chassis/Sled
- Ruggedization for: Shock & Vib; Hazardous Locations
- Shielding for High Magnetic Environment
- Sealed/IP Rated Enclosures
- Customized Print/Marking/Labels



### Communications & Control

- Logic Signal/Timing Changes
- Adaptive Fan Control
- Output Sequencing
- Peak Load/Efficiency Optimization

## Modified Solutions

Emerson provides modified standard products and value-add solutions in varying degrees of complexity. These meet specific customer needs in a wide range of applications, such as:



### Communications

- Access Solutions
- Enterprise Networking
- Wireless Communications
- Wireline Communications
- Optical Communications



### Healthcare

- Bio Life Sciences
- Dental
- Imaging
- Laboratory
- Medical



### Industrial

- Process Control
- Robotics
- Test & Measurement



### Lighting & Signage

- Displays
- Illuminated Signs



### Mil/Aero (COTS)

- Avionics
- In-flight Entertainment



## Terms and Conditions of Sale

The Emerson Network Power company that accepts Buyer's order for Goods is herein referred to as the "Seller" and the person or entity purchasing goods or services ("Goods") and/or licensing software and/or firmware which are preloaded, or to be loaded into Goods ("Software") from Seller is referred to as the "Buyer." These Terms and Conditions, any price list or schedule, quotation, acknowledgment or invoice from Seller relevant to the sale of the Goods and licensing of Software and all documents incorporated by specific reference herein or therein constitute the complete and exclusive statement of the terms governing the sale of Goods and license of Software by Seller to Buyer. Seller's acceptance of Buyer's purchase order is expressly conditional on Buyer's assent to all of Seller's terms and conditions of sale, including terms and conditions that are different from or additional to the terms and conditions of Buyer's purchase order. Buyer's acceptance of the Goods and/or Software will manifest Buyer's assent to these Terms and Conditions. Seller reserves the right in its sole discretion to refuse orders. Notwithstanding anything to the contrary, in the event that the provisions of these Terms and Conditions conflict with the provisions of an effective agreement signed by a duly authorized representative of both parties ("Effective Agreement") that applies to the transaction(s) contemplated herein, the Effective Agreement shall control.

**1. PRICES:** Unless otherwise specified in writing by Seller, the price quoted or specified by Seller for the Goods and/or Software shall remain in effect for 30 days after the date of Seller's quotation or acknowledgment of Buyer's order for the Goods and/or Software, whichever occurs first, provided an unconditional authorization from Buyer for the shipment of the Goods and/or Software is received and accepted by Seller within such time period. If such authorization is not received by Seller within such 30 day period, Seller shall have the right to change the price for the Goods and/or Software to Seller's price for the Goods and/or Software at the time of shipment. All prices and licensee fees are exclusive of taxes, transportation and insurance, which are to be borne by Buyer.

**2. TAXES:** Any current or future tax or governmental charge (or increase in same) affecting Seller's costs of production, sale, or shipment, or which Seller is otherwise required to pay or collect in connection with the sale, purchase, delivery, storage, processing, use or consumption of Goods, shall be for Buyer's account and shall be added to the price or billed to Buyer separately, at Seller's election.

**3. TERMS OF PAYMENT:** Unless otherwise specified by Seller, terms are net 30 days from date of Seller's invoice by bank wire transfer or automated clearing house in U.S. currency. Payment will be made no less frequent than weekly. Seller shall have the right, among other remedies, either to terminate this agreement or to suspend further performance under this and/or other agreements with Buyer in the event Buyer fails to make any payment when due, which other agreements Buyer and Seller hereby amend accordingly. Buyer shall be liable for all expenses, including attorneys' fees, relating to the collection of past due amounts. If any payment owed to Seller is not paid when due, it shall bear interest, at a rate to be determined by Seller, which shall not exceed the maximum rate permitted by law, from the date on which it is due until it is paid. Any payment due to either party under this agreement shall be made in full without any set-off, restriction, condition deduction or withholding for or on account of any counterclaim. Should Buyer's financial responsibility become unsatisfactory to Seller, cash payments or security satisfactory to Seller may be required by Seller for future deliveries of the Goods and/or Software. If such cash payment or security is not provided, in addition to Seller's other rights and remedies, Seller may discontinue deliveries.

**4. SHIPMENT AND DELIVERY:** While Seller will use all reasonable commercial efforts to maintain the delivery date(s) acknowledged or quoted by Seller, all shipping dates are approximate and not guaranteed. Seller reserves the right to make partial shipments. Seller, at its option, shall not be bound to tender delivery of any Goods and/or Software for which Buyer has not provided shipping instructions and other required information. If the shipment of the Goods and/or Software is postponed or delayed by Buyer for any reason, Buyer agrees to reimburse Seller for any and all storage costs and other additional expenses resulting therefrom. Risk of loss and legal title to the Goods shall transfer from Seller to Buyer upon delivery to and receipt by carrier at Seller's shipping point. Unless otherwise specified by Seller, all shipments are F.C.A. Seller's shipping point (Incoterms 2010). Any claims for shortages or damages suffered in transit are the responsibility of Buyer and shall be submitted by Buyer directly to the carrier. Shortages or damages must be identified and signed for at the time of delivery.

Buyer shall inspect Goods delivered to it by Seller immediately upon receipt, and, any course of dealing to the contrary notwithstanding, failure of Buyer to give Seller notice of any claim within 10 days after receipt of such Goods shall be an unqualified acceptance of such Goods.

**5. LIMITED WARRANTY:** Subject to the limitations of Section 6 and unless otherwise specified by Seller in writing, Seller warrants that the Goods manufactured by Seller will be free from defects in material and workmanship and substantially meet Seller's published specifications at the time of shipment under normal use and regular service and maintenance for (a) the period specified in Seller's then current product data sheets from the date of manufacture by Seller for standard Embedded Power Goods, (b) 2 years from initial shipment for standard Embedded Computing Goods, and (c) the period specified by Seller in writing for custom Embedded Power Goods and custom Embedded Computing Goods. Unless otherwise stated

in a separate Software license agreement, Seller makes no warranty as to any Software. **THE WARRANTIES SET FORTH IN SECTIONS 5 AND 7 ARE THE SOLE AND EXCLUSIVE WARRANTIES GIVEN BY SELLER WITH RESPECT TO THE GOODS AND SOFTWARE AND ARE IN LIEU OF AND EXCLUDE ALL OTHER WARRANTIES, EXPRESS OR IMPLIED, ARISING BY OPERATION OF LAW OR OTHERWISE, INCLUDING WITHOUT LIMITATION, MERCHANTABILITY AND FITNESS FOR A PARTICULAR PURPOSE WHETHER OR NOT THE PURPOSE OR USE HAS BEEN DISCLOSED TO SELLER IN SPECIFICATIONS, DRAWINGS OR OTHERWISE, AND WHETHER OR NOT SELLER'S PRODUCTS ARE SPECIFICALLY DESIGNED AND/OR MANUFACTURED BY SELLER FOR BUYER'S USE OR PURPOSE.**

These warranties do not extend to any losses or damages due to misuse, accident, abuse, neglect, negligence (other than Seller's), unauthorized modification or alteration, use beyond rated capacity, unsuitable power sources or environmental conditions, improper installation, repair, handling, maintenance or application or any other cause not the fault of Seller. To the extent that Buyer or its agents have supplied specifications, information, representation of operating conditions or other data to Seller in the selection or design of the Goods and the preparation of Seller's quotation, and in the event that actual operating conditions or other conditions differ from those represented by Buyer, any warranties or other provisions contained herein that are affected by such conditions shall be null and void.

If within 30 days after Buyer's discovery of any warranty defects within the warranty period, Buyer notifies Seller thereof in writing, Seller shall, at its option and as Buyer's exclusive remedy, repair, correct or replace per its return policy, or refund the purchase price for, that portion of the Goods found by Seller to be defective. Failure by Buyer to give such written notice within the applicable time period shall be deemed an absolute and unconditional waiver of Buyer's claim for such defects. Advance written permission to return Goods must be obtained from Seller. Such Goods must be shipped transportation prepaid to Seller. Returns made without proper written permission will not be accepted by Seller. Seller reserves the right to inspect Goods prior to authorizing return. Goods repaired or replaced during the warranty period shall be covered by the foregoing warranties for the remainder of the original warranty period or 90 days from the date of shipment, whichever is longer.

Buyer assumes all other responsibility for any loss, damage, or injury to persons or property arising out of, connected with, or resulting from the use of Goods and/or Software, either alone or in combination with other products/components.

**PRE-PRODUCTION (Prototype, Engineering Verification Test, or Design Verification Test) UNITS ARE SOLD "WHERE IS, AS IS, WITH ALL FAULTS" WITHOUT WARRANTY OF ANY KIND, EXPRESS OR IMPLIED, INCLUDING, WITHOUT LIMITATION, IMPLIED WARRANTIES OF MERCHANTABILITY OR FITNESS FOR INTENDED PURPOSE.**

**6. LIMITATION OF REMEDY AND LIABILITY: THE SOLE AND EXCLUSIVE REMEDY FOR BREACH OF ANY WARRANTY HEREUNDER (OTHER THAN THE WARRANTY PROVIDED UNDER SECTION 7) SHALL BE LIMITED TO REPAIR, CORRECTION OR REPLACEMENT, OR REFUND OF THE PURCHASE PRICE UNDER SECTION 5.**

**SELLER SHALL NOT BE LIABLE FOR DAMAGES CAUSED BY DELAY IN PERFORMANCE AND THE REMEDIES OF BUYER SET FORTH IN THIS AGREEMENT ARE EXCLUSIVE. IN NO EVENT, REGARDLESS OF THE FORM OF THE CLAIM OR CAUSE OF ACTION (WHETHER BASED IN CONTRACT, INFRINGEMENT, NEGLIGENCE, STRICT LIABILITY, OTHER TORT OR OTHERWISE), SHALL SELLER'S LIABILITY TO BUYER AND/OR ITS CUSTOMERS EXCEED THE PRICE PAID BY BUYER FOR THE SPECIFIC GOODS OR SOFTWARE PROVIDED BY SELLER GIVING RISE TO THE CLAIM OR CAUSE OF ACTION. BUYER AGREES THAT IN NO EVENT SHALL SELLER'S LIABILITY TO BUYER AND/OR ITS CUSTOMERS EXTEND TO INCLUDE INCIDENTAL, CONSEQUENTIAL OR PUNITIVE DAMAGES.** The term "consequential damages" shall include, but not be limited to, loss of anticipated profits, business interruption, loss of use, revenue, reputation and data, costs incurred, including without limitation, for capital, fuel, power and loss or damage to property or equipment.

It is expressly understood that any technical advice furnished by Seller with respect to the use of the Goods and/or Software is given without charge, and Seller assumes no obligation or liability for the advice given, or results obtained, all such advice being given and accepted at Buyer's risk.

**7. PATENTS AND COPYRIGHTS:** Subject to the limitations of the second paragraph of Section 6, Seller warrants that the Goods sold, except as are made specifically for Buyer according to Buyer's specifications, do not infringe any valid U.S. patent or copyright in existence as of the date of shipment. This warranty is given upon the condition that Buyer promptly notifies Seller of any claim or suit involving Buyer in which such infringement is alleged and cooperates fully with Seller and permits Seller to control completely the defense, settlement or compromise of any such allegation of infringement. Seller's warranty as to utility patents only applies to infringement arising solely out of the inherent operation according to Seller's specifications and instructions of such Goods. In the event such Goods are held to infringe such a U.S. patent or copyright in such suit, and / or the use of such Goods is enjoined, or in



# Terms and Conditions

the case of a compromise or settlement by Seller, Seller shall have the right, at its option and expense, to procure for Buyer the right to continue using such Goods, or replace them with non-infringing Goods, or modify same to become non-infringing, or grant Buyer a credit for the depreciated value of such Goods and accept return of them. In the event of the foregoing or, if in Seller's opinion, Seller receives a credible allegation of infringement, Seller may also, at its option, cancel or suspend this agreement as to future deliveries of such Goods, without liability.

**8. EXCUSE OF PERFORMANCE:** Seller shall not be liable for delays in performance or for non-performance due to acts of God; acts of Buyer; war; fire; flood; weather; sabotage; epidemics; strikes or labor disputes; civil disturbances or riots; governmental requests, restrictions, allocations, laws, regulations, orders or actions; unavailability of or delays in transportation; default of suppliers; or unforeseen circumstances or any events or causes beyond Seller's reasonable control. Deliveries or other performance may be suspended for an appropriate period of time or canceled by Seller upon notice to Buyer in the event of any of the foregoing, but the balance of the agreement shall otherwise remain unaffected as a result of the foregoing.

If Seller determines that its ability to supply the total demand for the Goods, or to obtain material used directly or indirectly in the manufacture of the Goods, is hindered, limited or made impracticable due to causes set forth in the preceding paragraph, Seller may allocate its available supply of the Goods or such material (without obligation to acquire other supplies of any such Goods or material) among its purchasers on such basis as Seller determines to be equitable without liability for any failure of performance which may result therefrom.

**9. RESCHEDULE/CANCELLATION:** Unless otherwise agreed in writing by Seller, orders under this agreement may not be rescheduled or canceled by Buyer for any reason.

**10. CHANGES:** Buyer may request changes or additions to the Goods and/or Software consistent with Seller's specifications and criteria. In the event such changes or additions are accepted by Seller, Seller may revise the price, license fees and dates of delivery.

Seller reserves the right to change designs and specifications for the Goods and/or Software without prior notice to Buyer, except with respect to Goods and/or Software being made to order for Buyer. Seller shall have no obligation to install or make such change in any Goods and/or Software manufactured prior to the date of such change.

**11. NUCLEAR/MEDICAL: GOODS AND SOFTWARE SOLD HEREUNDER ARE NOT FOR USE IN CONNECTION WITH ANY NUCLEAR, MEDICAL, LIFE-SUPPORT AND OTHER HIGH RISK APPLICATIONS WHERE GOODS OR SOFTWARE FAILURE COULD LEAD TO LOSS OF LIFE OR CATASTROPHIC PROPERTY DAMAGE.** Buyer accepts Goods and Software with the foregoing understanding, agrees to communicate the same in writing to any subsequent purchasers or users and to defend, indemnify and hold harmless Seller from any claims, losses, suits, judgments and damages, including incidental and consequential damages, arising from such use, whether the cause of action be based in tort, contract or otherwise, including allegations that the Seller's liability is based on negligence or strict liability.

**12. ASSIGNMENT:** Buyer shall not assign its rights or delegate its duties hereunder or any interest herein without the prior written consent of Seller, and any such assignment, without such consent, shall be void.

**13. SOFTWARE:** Notwithstanding any other provision herein to the contrary, Seller or applicable third party licensor to Seller shall retain all rights of ownership and title in its respective Software, including without limitation all rights of ownership and title in its respective copies of such Software. Except as otherwise provided herein, Buyer is hereby granted a nonexclusive, non-transferable royalty free license to use the Software incorporated into the Goods solely for purposes of Buyer properly utilizing such Goods purchased from Seller. All other Software shall be furnished to, and used by, Buyer only after execution of Seller's (or the licensor's) applicable standard license agreement, the terms of which are incorporated herein by reference. The Software is Seller's own or Seller's supplier's proprietary information, and Buyer and its employees and agents shall not disclose the Software to others without Seller's prior written consent.

**14. TOOLING:** Tool, die, and pattern charges, if any, are in addition to the price of the Goods and are due and payable upon completion of the tooling. All such tools, dies and patterns shall be and remain the property of Seller. Charges for tools, dies, and patterns do not convey to Buyer, title, ownership interest in, or rights to possession or removal, or prevent their use by Seller for other purchasers, except as otherwise expressly provided by Seller and Buyer in writing with reference to this provision.

**15. INTELLECTUAL PROPERTY:** Seller's intellectual property, including without limitation, all patents, copyrights, trade secrets, trade-dress and any other intellectual property of any kind (including without limitation, that which exists in the underlying technology), furnished by Seller to Buyer in connection with this agreement is the property of Seller and Seller retains all rights, including without limitation, exclusive rights of use, licensing, and sale. Possession of Goods, pre-production units, specifications, prints or drawings, or any other materials does not convey to Buyer any rights or license thereto.

**16. BUYER'S COMPLIANCE WITH LAWS:** In connection with the transactions contemplated by this agreement, Buyer is familiar with and shall fully comply with all applicable laws, regulations, rules and other requirements of the United States and of any applicable state, foreign and local governmental body in connection with the purchase, license, receipt, use, transfer and disposal of the Goods and/or Software.

**17. EXPORT/IMPORT:** Buyer agrees that all applicable import and export control laws, regulations, orders and requirements, including without limitation those of the United States and the European Union, and the jurisdictions in which the Seller and Buyer are established or from which Goods and/or Software may be supplied, will apply to their receipt and use. In no event shall Buyer use, transfer, release, import, export, Goods and/or Software in violation of such applicable laws, regulations, orders or requirements.

**18. GOVERNMENT CONTRACT CONDITIONS:** In the event Buyer supplies Goods or Software to the U.S. Government or to a prime contractor selling to the U.S. Government, the following Federal Acquisition Regulation (FAR) clauses are accepted by Seller and are made part of this agreement applicable to such supply: 52.222-21 Prohibition of Segregated Facilities; 52.222-26 Equal Opportunity; 52.222-35 Equal Opportunity For Special Disabled Veterans, Veterans of Vietnam Era, and Other Eligible Veterans; 52.222-36 Affirmative Action For Workers with Disabilities; and 52.219-8 Utilization of Small Business Concerns. No additional FAR or FAR Supplement clauses are accepted by Seller. In the event Buyer elects to sell Goods or Software to the U.S. Government or any national, state, provincial or local non-U.S. governmental entity or to a prime contractor selling to such entities, Buyer does so solely at its own option and risk, and agrees not to obligate Seller as a subcontractor or otherwise to the U.S. Government or other governmental entity except as described in this Section 18. Buyer remains solely and exclusively responsible for compliance with all statutes and regulations governing sales to the U.S. Government or any national, state, provincial or local non-U.S. governmental entity. Seller makes no representations, certifications or warranties whatsoever with respect to the ability of its Goods, Software, or prices to satisfy any such statutes and regulations.

**19. GENERAL PROVISIONS:** These terms and conditions supersede all other communications, negotiations and prior oral or written statements regarding the subject matter of these terms and conditions. No change, modification, rescission, discharge, abandonment, or waiver of these terms and conditions shall be binding upon the Seller unless made in writing and signed on its behalf by a duly authorized representative of Seller. No conditions, usage of trade, course of dealing or performance, understanding or agreement purporting to modify, vary, explain, or supplement these terms and conditions shall be binding unless hereafter made in writing and signed by the party to be bound, and no modification or additional terms shall be applicable to this agreement by Seller's receipt, acknowledgment, or acceptance of purchase orders, shipping instruction forms, or other documentation containing terms at variance with or in addition to those set forth herein. Any such modifications or additional terms are specifically rejected and deemed a material alteration hereof. If this document shall be deemed an acceptance of a prior offer by Buyer, such acceptance is expressly conditional upon Buyer's assent to any additional or different terms set forth herein. No waiver by either party with respect to any breach or default or of any right or remedy, and no course of dealing, shall be deemed to constitute a continuing waiver of any other breach or default or of any other right or remedy, unless such waiver be expressed in writing and signed by the party to be bound. All typographical or clerical errors made by Seller in any quotation, acknowledgment or publication are subject to correction. In the event that any provision or portion thereof contained in the Contract is held to be unenforceable, the Contract shall be construed without such provision or portion thereof.

(A) If Seller is a U.S. incorporated entity: This Agreement shall be governed by the laws of the State of Delaware, U.S.A., without reference to its choice or conflict of laws principles. The parties agree to submit to the exclusive jurisdiction of the courts of the State of Delaware for all actions arising in connection herewith.

(B) If Seller is a European incorporated entity: This Agreement shall be governed by the laws of England. Any dispute arising out of or in connection with this Agreement that cannot be resolved through friendly consultation shall be referred to and finally resolved by arbitration in London, England before the London Court of International Arbitration in accordance with its arbitration rules. The arbitral award shall be final and binding on the parties.

(C) If Seller is an entity incorporated in the Asia Pacific region: This Agreement shall be governed by the laws of the Hong Kong Special Administrative Region of the People's Republic of China. Any dispute arising out of or in connection with this Agreement that cannot be resolved through friendly consultation shall be referred to and finally resolved by arbitration in Hong Kong before the Hong Kong International Arbitration Centre in accordance with its arbitration rules. The arbitral award shall be final and binding on the parties.

(D) No action, regardless of form, arising out of transactions relating to this agreement, may be brought by either party more than two (2) years after the cause of action has accrued. The U.N. Convention on Contracts for the International Sales of Goods shall not apply to this agreement.

Revised March 13, 2012

## Technology Index

Section	Page	Section	Page	Section	Page
<b>Low Power</b>		<b>Medium Power</b>		<b>Industry Standard Non-Isolated</b>	
LCC	15, 16	MP	27, 28	APA	63
LCT	10			APC	63
LPQ	13, 14	<b>Intelligent Medium Power</b>		LDO	62
LPS	10, 11, 12, 13, 14	iMP	29, 30, 31	LGA	62
LPT	10, 11, 12, 13	<b>Intelligent High Power</b>		PTH	65
NLP	10, 12, 14	iVS	32, 33, 34	PTV	65
NPS	10, 11	<b>Bulk Power</b>		SIL	61, 62, 63
NTS	14	HPR	42	SMT	61, 62, 63, 64
TLP	13	HPS	41, 42	VRM	66
<b>External Power</b>		LCM	35, 36, 37, 38, 39, 40	<b>High Power</b>	
AD	18, 19	UFE	41, 42, 43	AIF	68
DA	18	<b>Distributed Power</b>		AIH	68
DCH	17	DS	44, 45, 46, 47, 48, 49	AIQ	68
DP	19	<b>Din Rail</b>		AIT	68
DPS	19	ADN	50, 51	PSE1000	68
<b>Medical Power</b>		<b>Industry Standard Isolated</b>		<b>Low Power DC-DC Product</b>	
DA	23	AEO	56	AEE	69
DPS	23	AEQ	58	AET	70
iMP	23	AGH	59	ASA	69
iVS	23	AGQ	57, 58	<b>DC-DC Converter for Railway Application</b>	
LCC	22	ALD	54	ERM	70
LCM	22	ALO	55		
LPQ	22	ALQ	58		
LPS	20, 21, 22	AVE	59, 60		
LPT	20, 21	AVQ	58		
NLP	21, 22	BXB	59		
NPS	20, 21	EXB	59, 60		
NTS	22	LES	55, 56		
TLP	21	LQS	57, 58		
μMP	22	RFB	60		
<b>LED Drivers</b>					
LDS	24				
<b>Micro Medium Power</b>					
μMP	25, 26				

## Ecosystem Leadership

Just as nature relies on communities of organisms functioning as an ecological unit, embedded power solutions depend on a broad and powerful ecosystem, including standards bodies, industry associations, technology alliances and engineering communities. Emerson Network Power brings a wealth of innovation and many years experience to accredited standards development organizations, specification consortia and industry associations through our executive memberships and key committee positions. We have long been committed to a strong ecosystem that works to further the development of the industries and technologies that are important to our customers' success.



Emerson, Emerson. Consider It Solved, Business-Critical Continuity and Emerson Network Power are trademarks of Emerson Electric Co. or one of its affiliated companies. PICMG, AdvancedTCA, ATCA, MicroTCA, and the AdvancedTCA and MicroTCA logos are trademarks of the PCI Industrial Computer Manufacturers Group. Intel is a trademark or registered trademark of Intel Corporation or its subsidiaries in the US and other countries. PMBus and the PMBus logo are trademarks of System Management Interface Forum, Inc. POLA logo and Auto-Track are trademarks of Texas Instruments Incorporated. The word mark "The Green Grid" and The Green Grid design mark or logo are service marks of The Green Grid Association. All other trademarks are the property of their respective owners. ©2011 Emerson Electric Co.

### Emerson Network Power.

The global leader in enabling *Business Critical Continuity*™.

- |              |  |                            |                             |
|--------------|--|----------------------------|-----------------------------|
| AC Power     | Embedded Computing                     | Outside Plant              | Racks & Integrated Cabinets |
| Connectivity | <b>Embedded Power</b>                  | Power Switching & Controls | Services                    |
| DC Power     | Infrastructure Management & Monitoring | Precision Cooling          | Surge Protection            |

## Americas

5810 Van Allen Way  
Carlsbad, CA 92008  
USA  
Telephone: +1 760 930 4600  
Facsimile: +1 760 930 0698

## Europe (UK)

Waterfront Business Park  
Merry Hill, Dudley  
West Midlands, DY5 1LX  
United Kingdom  
Telephone: +44 (0) 1384 842 211  
Facsimile: +44 (0) 1384 843 355

## Asia (HK)

14/F, Lu Plaza  
2 Wing Yip Street  
Kwun Tong, Kowloon  
Hong Kong  
Telephone: +852 2176 3333  
Facsimile: +852 2176 3888

For global contact, visit:

[Emerson.com/EmbeddedPower](http://Emerson.com/EmbeddedPower)

[TechSupport.EmbeddedPower@Emerson.com](mailto:TechSupport.EmbeddedPower@Emerson.com)

While every precaution has been taken to ensure accuracy and completeness in this literature, Emerson Network Power assumes no responsibility, and disclaims all liability for damages resulting from use of this information or for any errors or omissions.

Issue AP1 June 2013

[EmersonNetworkPower.com](http://EmersonNetworkPower.com)

Компания «Океан Электроники» предлагает заключение долгосрочных отношений при поставках импортных электронных компонентов на взаимовыгодных условиях!

Наши преимущества:

- Поставка оригинальных импортных электронных компонентов напрямую с производств Америки, Европы и Азии, а так же с крупнейших складов мира;
- Широкая линейка поставок активных и пассивных импортных электронных компонентов (более 30 млн. наименований);
- Поставка сложных, дефицитных, либо снятых с производства позиций;
- Оперативные сроки поставки под заказ (от 5 рабочих дней);
- Экспресс доставка в любую точку России;
- Помощь Конструкторского Отдела и консультации квалифицированных инженеров;
- Техническая поддержка проекта, помощь в подборе аналогов, поставка прототипов;
- Поставка электронных компонентов под контролем ВП;
- Система менеджмента качества сертифицирована по Международному стандарту ISO 9001;
- При необходимости вся продукция военного и аэрокосмического назначения проходит испытания и сертификацию в лаборатории (по согласованию с заказчиком);
- Поставка специализированных компонентов военного и аэрокосмического уровня качества (Xilinx, Altera, Analog Devices, Intersil, Interpoint, Microsemi, Actel, Aeroflex, Peregrine, VPT, Syfer, Eurofarad, Texas Instruments, MS Kennedy, Miteq, Cobham, E2V, MA-COM, Hittite, Mini-Circuits, General Dynamics и др.);

Компания «Океан Электроники» является официальным дистрибьютором и эксклюзивным представителем в России одного из крупнейших производителей разъемов военного и аэрокосмического назначения «JONHON», а так же официальным дистрибьютором и эксклюзивным представителем в России производителя высокотехнологичных и надежных решений для передачи СВЧ сигналов «FORSTAR».



## JONHON

«JONHON» (основан в 1970 г.)

Разъемы специального, военного и аэрокосмического назначения:

(Применяются в военной, авиационной, аэрокосмической, морской, железнодорожной, горно- и нефтедобывающей отраслях промышленности)

«FORSTAR» (основан в 1998 г.)

ВЧ соединители, коаксиальные кабели,  
кабельные сборки и микроволновые компоненты:

(Применяются в телекоммуникациях гражданского и специального назначения, в средствах связи, РЛС, а так же военной, авиационной и аэрокосмической отраслях промышленности).



Телефон: 8 (812) 309-75-97 (многоканальный)

Факс: 8 (812) 320-03-32

Электронная почта: [ocean@oceanchips.ru](mailto:ocean@oceanchips.ru)

Web: <http://oceanchips.ru/>

Адрес: 198099, г. Санкт-Петербург, ул. Калинина, д. 2, корп. 4, лит. А