

FDM3622

N-Channel PowerTrench® MOSFET

100V, 4.4A, 60mΩ

Features

- Max $r_{DS(on)}$ = 60mΩ at $V_{GS} = 10V$, $I_D = 4.4A$
- Max $r_{DS(on)}$ = 80mΩ at $V_{GS} = 6.0V$, $I_D = 3.8A$
- Low Miller Charge
- Low QRR Body Diode
- Optimized efficiency at high frequencies
- UIS Capability (Single Pulse and Repetitive Pulse)
- RoHS Compliant



General Description

This N-Channel MOSFET is produced using Fairchild Semiconductor's advanced PowerTrench® process that has been especially tailored to minimize the on-state resistance and yet maintain low gate charge for superior switching performance.

Applications

- Distributed Power Architectures and VRMs.
- Primary Switch for 24V and 48V Systems
- High Voltage Synchronous Rectifier
- Formerly developmental type 82744

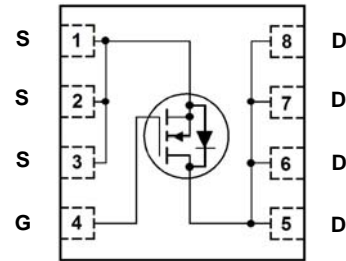
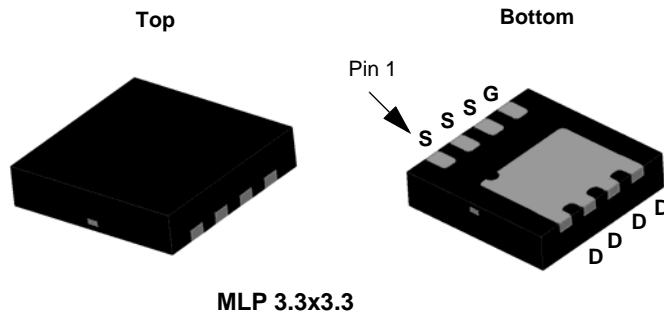

MOSFET Maximum Ratings $T_A = 25^\circ\text{C}$ unless otherwise noted

Symbol	Parameter	Ratings	Units
V_{DS}	Drain to Source Voltage	100	V
V_{GS}	Gate to Source Voltage	±20	V
I_D	Drain Current -Continuous (Note 1a)	4.4	A
	-Pulsed	20	
E_{AS}	Single Pulse Avalanche Energy (Note 3)	54	mJ
P_D	Power Dissipation (Note 1a)	2.1	W
	Power Dissipation (Note 1b)	0.9	
T_J, T_{STG}	Operating and Storage Junction Temperature Range	-55 to +150	°C

Thermal Characteristics

$R_{\theta JC}$	Thermal Resistance, Junction to Case (Note 1)	3.0	°C/W
$R_{\theta JA}$	Thermal Resistance, Junction to Ambient (Note 1a)	60	

Package Marking and Ordering Information

Device Marking	Device	Package	Reel Size	Tape Width	Quantity
FDM3622	FDM3622	MLP 3.3x3.3	13"	12 mm	3000 units

Electrical Characteristics $T_J = 25^\circ\text{C}$ unless otherwise noted

Symbol	Parameter	Test Conditions	Min	Typ	Max	Units
--------	-----------	-----------------	-----	-----	-----	-------

Off Characteristics

BV_{DSS}	Drain to Source Breakdown Voltage	$I_D = 250\mu\text{A}, V_{GS} = 0\text{V}$	100			V
I_{DSS}	Zero Gate Voltage Drain Current	$V_{DS} = 80\text{V}, V_{GS} = 0\text{V}$ $T_J = 100^\circ\text{C}$			1	μA
					250	
I_{GSS}	Gate to Source Leakage Current	$V_{GS} = \pm 20\text{V}, V_{DS} = 0\text{V}$			± 100	nA

On Characteristics

$V_{GS(th)}$	Gate to Source Threshold Voltage	$V_{GS} = V_{DS}, I_D = 250\mu\text{A}$	2		4	V
$r_{DS(on)}$	Static Drain to Source On Resistance	$V_{GS} = 10\text{V}, I_D = 4.4\text{A}$		44	60	$\text{m}\Omega$
		$V_{GS} = 6.0\text{V}, I_D = 3.8\text{A}$		56	80	
		$V_{GS} = 10\text{V}, I_D = 4.4\text{A}, T_J = 150^\circ\text{C}$		92	120	

Dynamic Characteristics

C_{iss}	Input Capacitance	$V_{DS} = 25\text{V}, V_{GS} = 0\text{V},$ $f = 1\text{MHz}$		820	1090	pF
C_{oss}	Output Capacitance			125	170	
C_{rss}	Reverse Transfer Capacitance			35	55	
R_g	Gate Resistance	$V_{DS} = 15\text{mV}, f = 1\text{MHz}$	0.1	3.1	6.2	Ω

Switching Characteristics

$t_{d(on)}$	Turn-On Delay Time	$V_{DD} = 50\text{V}, I_D = 4.4\text{A}$ $V_{GS} = 10\text{V}, R_{GEN} = 24\Omega$		11	20	ns
t_r	Rise Time			25	40	
$t_{d(off)}$	Turn-Off Delay Time			35	56	
t_f	Fall Time			26	42	
Q_g	Total Gate Charge	$V_{GS} = 10\text{V}$		13	17	nC
Q_{gs}	Gate to Source Gate Charge	$V_{DD} = 50\text{V}$		3.6		
Q_{gd}	Gate to Drain "Miller" Charge	$I_D = 4.4\text{A}$		3.4		

Drain-Source Diode Characteristics

V_{SD}	Source to Drain Diode Forward Voltage	$V_{GS} = 0\text{V}, I_S = 4.4\text{A}$			1.25	V
		$V_{GS} = 0\text{V}, I_S = 2.2\text{A}$			1.0	V
t_{rr}	Reverse Recovery Time	$I_F = 4.4\text{A}, di/dt = 100\text{A}/\mu\text{s}$			56	ns
Q_{rr}	Reverse Recovery Charge				108	

Notes:

1: $R_{\theta JA}$ is determined with the device mounted on a 1 in² oz copper pad on a 1.5 x 1.5 in. board of FR-4 material. $R_{\theta JC}$ is guaranteed by design while $R_{\theta JA}$ is determined by the user's board design.

- (a) $R_{\theta JA} = 60^\circ\text{C}/\text{W}$ when mounted on a 1 in² pad of 2 oz copper, 1.5x1.5x0.062" thick PCB.
 (b) $R_{\theta JA} = 135^\circ\text{C}/\text{W}$ when mounted on a minimum pad of 2 oz copper.

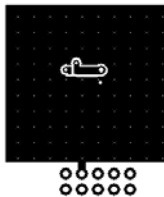

a. $60^\circ\text{C}/\text{W}$ when mounted on a 1 in² pad of 2 oz copper



b. $135^\circ\text{C}/\text{W}$ when mounted on a minimum pad of 2 oz copper

2: Pulse Test: Pulse Width < 300 μs , Duty cycle < 2.0%.

3: E_{AS} of 54 mJ is based on starting $T_J = 25^\circ\text{C}$; N-ch: L = 3 mH, $I_{AS} = 6\text{A}$, $V_{DD} = 100\text{V}$, $V_{GS} = 10\text{V}$.

Typical Characteristics $T_J = 25^\circ\text{C}$ unless otherwise noted

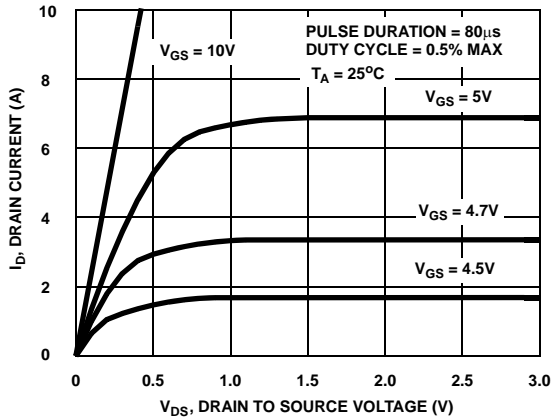

Figure 1. On-Region Characteristics

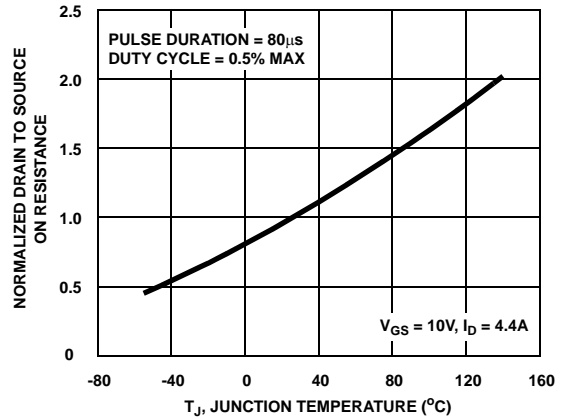

Figure 2. Normalized On-Resistance vs Junction Temperature

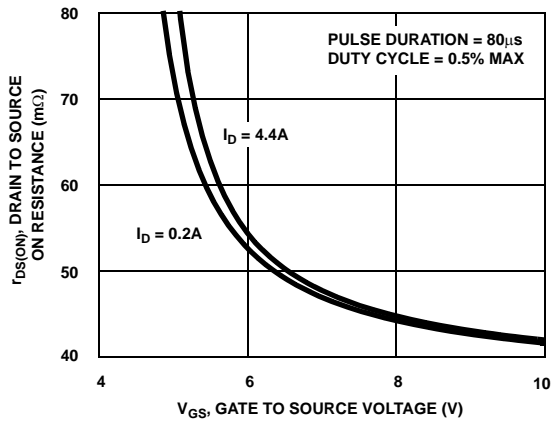

Figure 3. On-Resistance vs Gate to Source Voltage

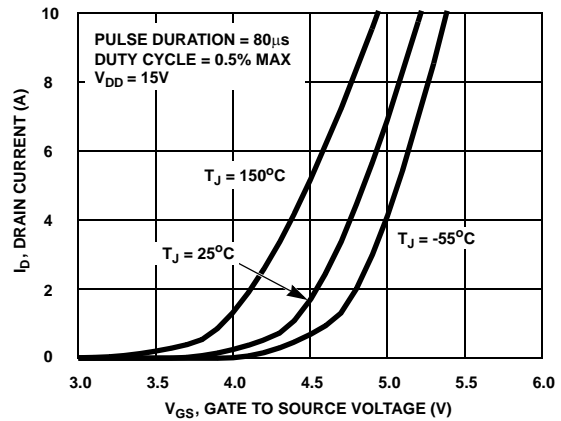

Figure 4. Transfer Characteristics

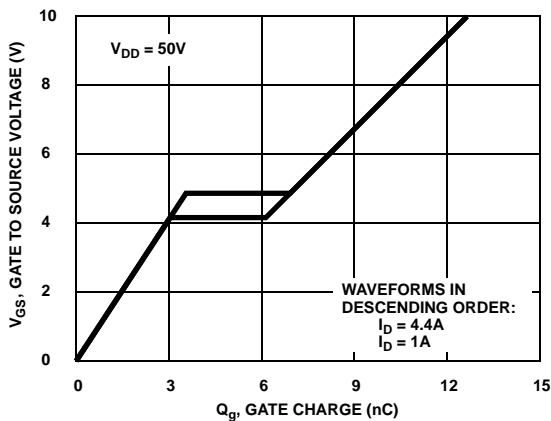

Figure 5. Gate Charge Characteristics

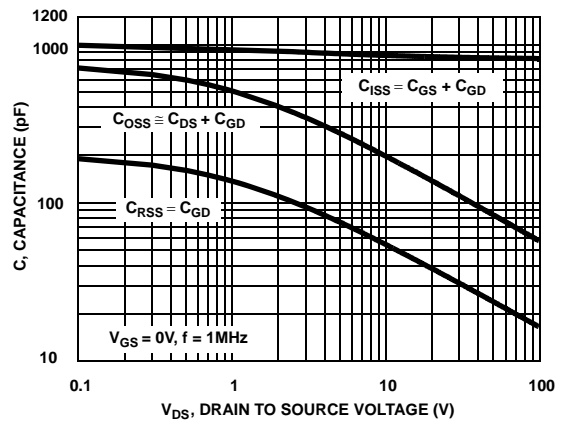

Figure 6. Capacitance vs Drain to Source Voltage

Typical Characteristics $T_J = 25^\circ\text{C}$ unless otherwise noted

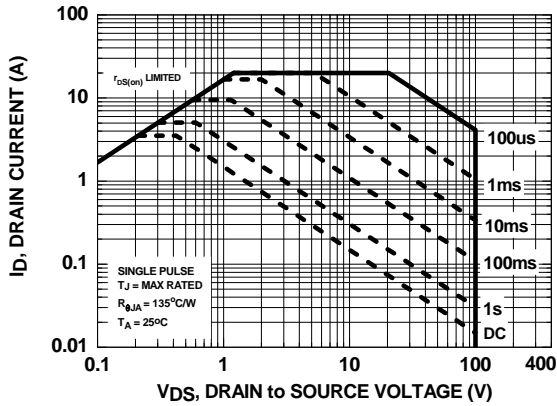

Figure 7. Forward Bias Safe Operating Area

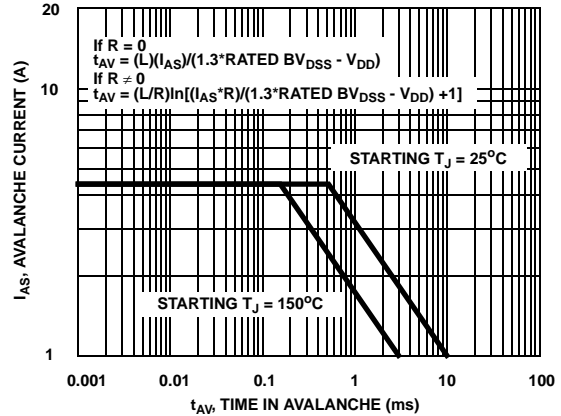

Figure 8. Uncalamped Inductive Switching Capability

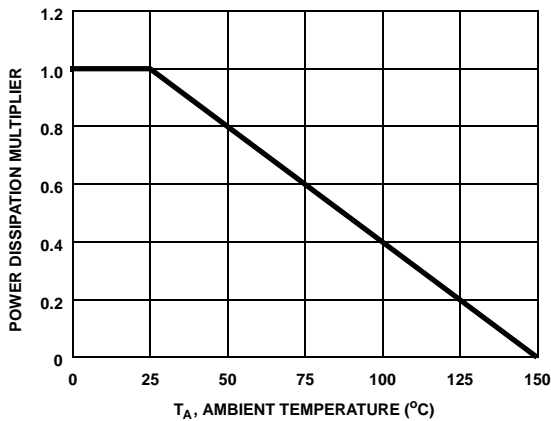

Figure 9. Normalized Power dissipation vs Ambient Temperature

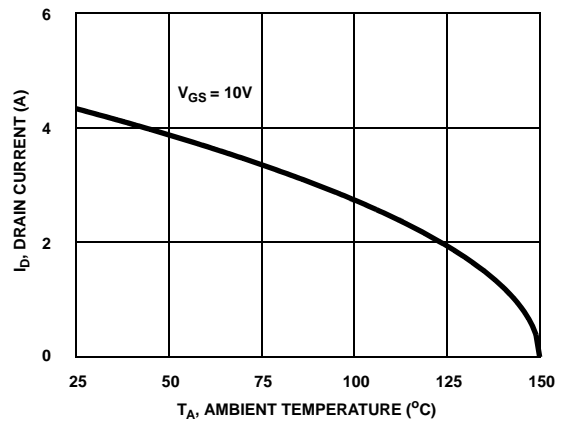

Figure 10. Maximum Continuous Drain Current vs Ambient Temperature

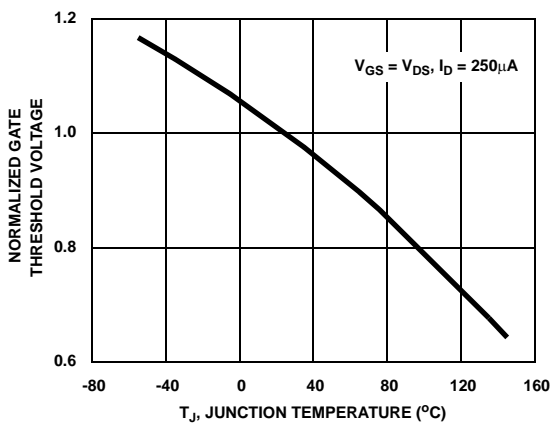

Figure 11. Normalized Gate Threshold voltage vs Junction Temperature

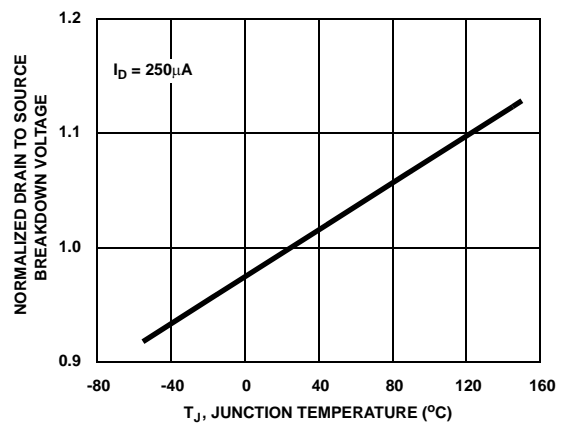

Figure 12. Normalized Drain to Source Breakdown Voltage vs Junction Temperature

Typical Characteristics $T_J = 25^\circ\text{C}$ unless otherwise noted

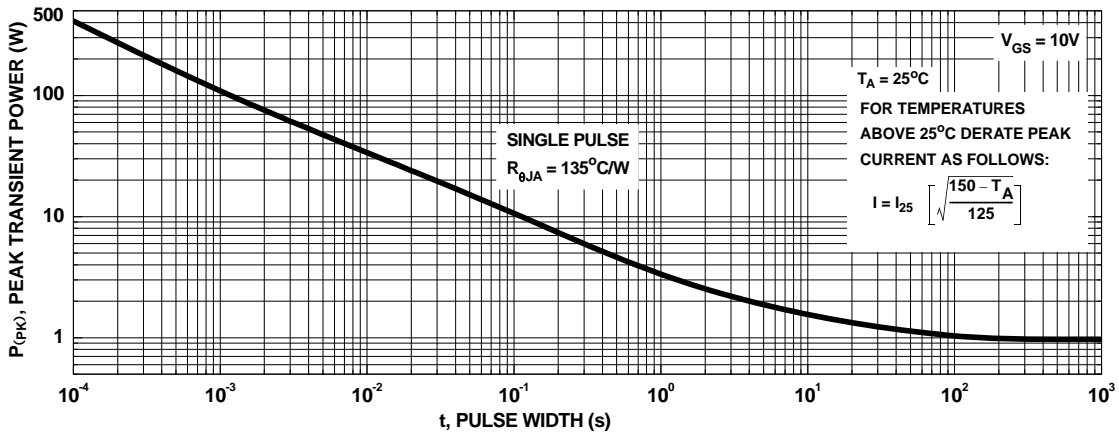

Figure 13. Peak Current Capability

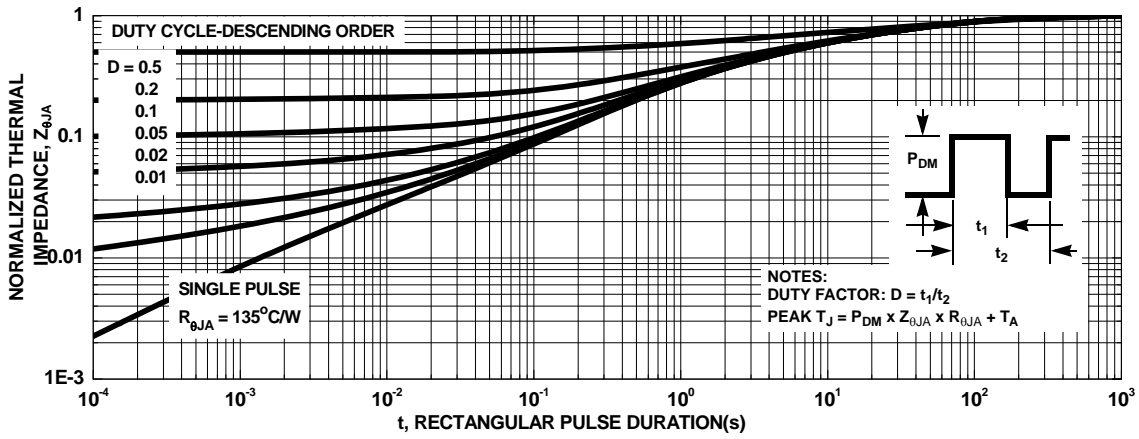
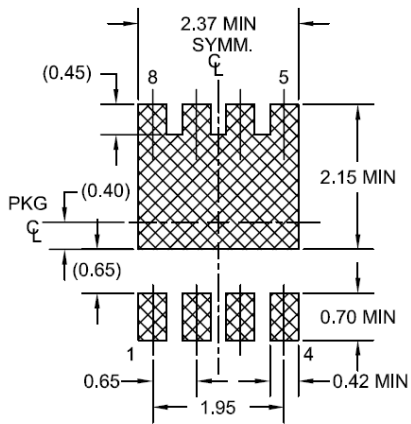
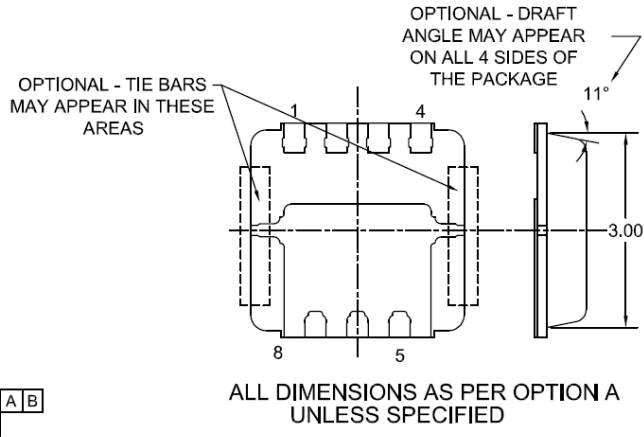
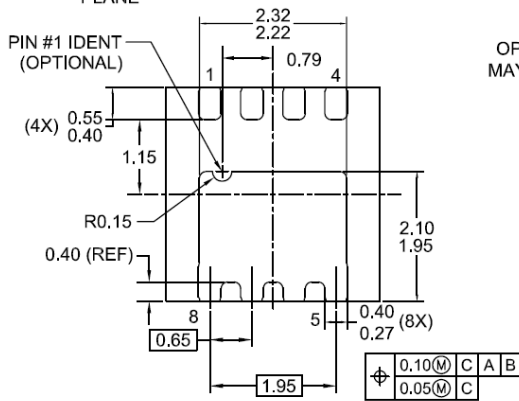
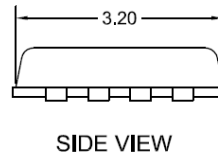
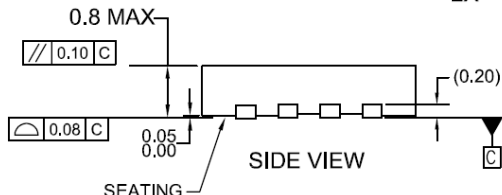
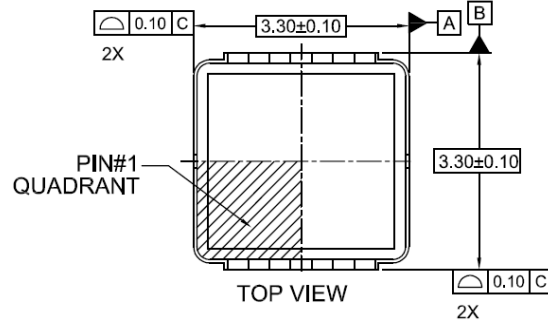
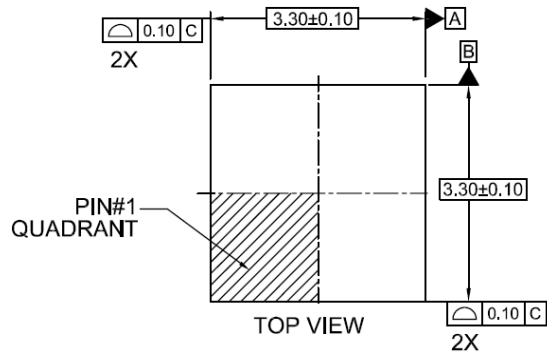

Figure 14. Transient Thermal Response Curve

Dimensional Outline and Pad Layout







NOTES:

- A. PACKAGE DOES NOT FULLY CONFORM TO JEDEC REGISTRATION MO-240.
- B. DIMENSIONS ARE IN MILLIMETERS.
- C. DIMENSIONS AND TOLERANCES PER ASME Y14.5M, 1994.
- D. DIMENSIONS DOES NOT INCLUDE BURRS OR MOLD FLASH. BURRS OR MOLD FLASH SHALL NOT EXCEED 0.10MM.
- E. LAND PATTERN RECOMMENDATION IS BASED ON FSC DESIGN ONLY.
- F. DRAWING FILENAME:



TRADEMARKS

The following includes registered and unregistered trademarks and service marks, owned by Fairchild Semiconductor and/or its global subsidiaries, and is not intended to be an exhaustive list of all such trademarks.

- | | | | |
|----------------------------------------------------------------------------------------------|-------------------------------------------------|----------------------------------------------------------------------------------------------------|-------------------------------------------------------------------------------------|
| 2Cool™ | F-PFS™ | PowerTrench® | The Power Franchise® |
| AccuPower™ | FRFET® | PowerXS™ | the power® |
| AX-CAP™* | Global Power Resource™ | Programmable Active Droop™ | franchise™ |
| BitSic® | Green Bridge™ | QFET® | TinyBoost™ |
| Build it Now™ | Green FPS™ | QS™ | TinyBuck™ |
| CorePLUS™ | Green FPS™ e-Series™ | Quiet Series™ | TinyCalc™ |
| CorePOWER™ | Gmax™ | RapidConfigure™ | TinyLogic® |
| CROSSVOLT™ | GTO™ |  ™ | TINYOPTO™ |
| CTL™ | IntelliMAX™ | Saving our world, 1mW/W/kW at a time™ | TinyPower™ |
| Current Transfer Logic™ | ISOPLANAR™ | SignalWise™ | TinyPWM™ |
| DEUXPEED® | Marking Small Speakers Sound Louder and Better™ | SmartMax™ | TinyWire™ |
| Dual Cool™ | MegaBuck™ | SMART START™ | TranSiC® |
| EcoSPARK® | MICROCOUPLER™ | Solutions for Your Success™ | TriFault Detect™ |
| EfficientMax™ | MicroFET™ | SPM® | TRUECURRENT®* |
| ESBC™ | MicroPak™ | STEALTH™ | µSerDes™ |
|  Fairchild® | MicroPak2™ | SuperFET® |  |
| Fairchild Semiconductor® | MillerDrive™ | SuperSOT™-3 | UHC® |
| FACT Quiet Series™ | MotionMax™ | SuperSOT™-6 | Ultra FRFET™ |
| FACT® | Motion-SPM™ | SuperSOT™-8 | UniFET™ |
| FAST® | mWSaver™ | SupreMOS® | VCX™ |
| FastvCore™ | OptoHiT™ | SyncFET™ | VisualMax™ |
| FETBench™ | OPTOLOGIC® | Sync-Lock™ | VoltagePlus™ |
| FlashWriter®* | OPTOPLANAR® |  SYSTEM GENERAL®* | XS™ |
| FPST™ | | | |

*Trademarks of System General Corporation, used under license by Fairchild Semiconductor.

DISCLAIMER

FAIRCHILD SEMICONDUCTOR RESERVES THE RIGHT TO MAKE CHANGES WITHOUT FURTHER NOTICE TO ANY PRODUCTS HEREIN TO IMPROVE RELIABILITY, FUNCTION, OR DESIGN. FAIRCHILD DOES NOT ASSUME ANY LIABILITY ARISING OUT OF THE APPLICATION OR USE OF ANY PRODUCT OR CIRCUIT DESCRIBED HEREIN; NEITHER DOES IT CONVEY ANY LICENSE UNDER ITS PATENT RIGHTS, NOR THE RIGHTS OF OTHERS. THESE SPECIFICATIONS DO NOT EXPAND THE TERMS OF FAIRCHILD'S WORLDWIDE TERMS AND CONDITIONS, SPECIFICALLY THE WARRANTY THEREIN, WHICH COVERS THESE PRODUCTS.

LIFE SUPPORT POLICY

FAIRCHILD'S PRODUCTS ARE NOT AUTHORIZED FOR USE AS CRITICAL COMPONENTS IN LIFE SUPPORT DEVICES OR SYSTEMS WITHOUT THE EXPRESS WRITTEN APPROVAL OF FAIRCHILD SEMICONDUCTOR CORPORATION.

As used here in:

- Life support devices or systems are devices or systems which, (a) are intended for surgical implant into the body or (b) support or sustain life, and (c) whose failure to perform when properly used in accordance with instructions for use provided in the labeling, can be reasonably expected to result in a significant injury of the user.
- A critical component in any component of a life support, device, or system whose failure to perform can be reasonably expected to cause the failure of the life support device or system, or to affect its safety or effectiveness.

ANTI-COUNTERFEITING POLICY

Fairchild Semiconductor Corporation's Anti-Counterfeiting Policy. Fairchild's Anti-Counterfeiting Policy is also stated on our external website, www.fairchildsemi.com, under Sales Support.

Counterfeiting of semiconductor parts is a growing problem in the industry. All manufactures of semiconductor products are experiencing counterfeiting of their parts. Customers who inadvertently purchase counterfeit parts experience many problems such as loss of brand reputation, substandard performance, failed application, and increased cost of production and manufacturing delays. Fairchild is taking strong measures to protect ourselves and our customers from the proliferation of counterfeit parts. Fairchild strongly encourages customers to purchase Fairchild parts either directly from Fairchild or from Authorized Fairchild Distributors who are listed by country on our web page cited above. Products customers buy either from Fairchild directly or from Authorized Fairchild Distributors are genuine parts, have full traceability, meet Fairchild's quality standards for handling and storage and provide access to Fairchild's full range of up-to-date technical and product information. Fairchild and our Authorized Distributors will stand behind all warranties and will appropriately address and warranty issues that may arise. Fairchild will not provide any warranty coverage or other assistance for parts bought from Unauthorized Sources. Fairchild is committed to combat this global problem and encourage our customers to do their part in stopping this practice by buying direct or from authorized distributors.

PRODUCT STATUS DEFINITIONS

Definition of Terms

Datasheet Identification	Product Status	Definition
Advance Information	Formative / In Design	Datasheet contains the design specifications for product development. Specifications may change in any manner without notice.
Preliminary	First Production	Datasheet contains preliminary data; supplementary data will be published at a later date. Fairchild Semiconductor reserves the right to make changes at any time without notice to improve design.
No Identification Needed	Full Production	Datasheet contains final specifications. Fairchild Semiconductor reserves the right to make changes at any time without notice to improve the design.
Obsolete	Not In Production	Datasheet contains specifications on a product that is discontinued by Fairchild Semiconductor. The datasheet is for reference information only.

Компания «Океан Электроники» предлагает заключение долгосрочных отношений при поставках импортных электронных компонентов на взаимовыгодных условиях!

Наши преимущества:

- Поставка оригинальных импортных электронных компонентов напрямую с производств Америки, Европы и Азии, а так же с крупнейших складов мира;
- Широкая линейка поставок активных и пассивных импортных электронных компонентов (более 30 млн. наименований);
- Поставка сложных, дефицитных, либо снятых с производства позиций;
- Оперативные сроки поставки под заказ (от 5 рабочих дней);
- Экспресс доставка в любую точку России;
- Помощь Конструкторского Отдела и консультации квалифицированных инженеров;
- Техническая поддержка проекта, помощь в подборе аналогов, поставка прототипов;
- Поставка электронных компонентов под контролем ВП;
- Система менеджмента качества сертифицирована по Международному стандарту ISO 9001;
- При необходимости вся продукция военного и аэрокосмического назначения проходит испытания и сертификацию в лаборатории (по согласованию с заказчиком);
- Поставка специализированных компонентов военного и аэрокосмического уровня качества (Xilinx, Altera, Analog Devices, Intersil, Interpoint, Microsemi, Actel, Aeroflex, Peregrine, VPT, Syfer, Eurofarad, Texas Instruments, MS Kennedy, Miteq, Cobham, E2V, MA-COM, Hittite, Mini-Circuits, General Dynamics и др.);

Компания «Океан Электроники» является официальным дистрибьютором и эксклюзивным представителем в России одного из крупнейших производителей разъемов военного и аэрокосмического назначения «**JONHON**», а так же официальным дистрибьютором и эксклюзивным представителем в России производителя высокотехнологичных и надежных решений для передачи СВЧ сигналов «**FORSTAR**».



JONHON

«**JONHON**» (основан в 1970 г.)

Разъемы специального, военного и аэрокосмического назначения:

(Применяются в военной, авиационной, аэрокосмической, морской, железнодорожной, горно- и нефтедобывающей отраслях промышленности)

«**FORSTAR**» (основан в 1998 г.)

ВЧ соединители, коаксиальные кабели,
кабельные сборки и микроволновые компоненты:

(Применяются в телекоммуникациях гражданского и специального назначения, в средствах связи, РЛС, а так же военной, авиационной и аэрокосмической отраслях промышленности).



Телефон: 8 (812) 309-75-97 (многоканальный)

Факс: 8 (812) 320-03-32

Электронная почта: ocean@oceanchips.ru

Web: <http://oceanchips.ru/>

Адрес: 198099, г. Санкт-Петербург, ул. Калинина, д. 2, корп. 4, лит. А