

EVALUATION KIT  
AVAILABLE**MAXIM****400MHz to 2.5GHz, Low-Noise,  
SiGe Downconverter Mixers****General Description**

The MAX2680/MAX2681/MAX2682 miniature, low-cost, low-noise downconverter mixers are designed for low-voltage operation and are ideal for use in portable communications equipment. Signals at the RF input port are mixed with signals at the local oscillator (LO) port using a double-balanced mixer. These downconverter mixers operate with RF input frequencies between 400MHz and 2500MHz, and downconvert to IF output frequencies between 10MHz and 500MHz.

The MAX2680/MAX2681/MAX2682 operate from a single +2.7V to +5.5V supply, allowing them to be powered directly from a 3-cell NiCd or a 1-cell Lithium battery. These devices offer a wide range of supply currents and input intercept (IIP3) levels to optimize system performance. Additionally, each device features a low-power shutdown mode in which it typically draws less than 0.1µA of supply current. Consult the *Selector Guide* for various combinations of IIP3 and supply current.

The MAX2680/MAX2681/MAX2682 are manufactured on a high-frequency, low-noise, advanced silicon-germanium process and are offered in the space-saving 6-pin SOT23 package.

**Applications**

400MHz/900MHz/2.4GHz ISM-Band Radios  
Personal Communications Systems (PCS)  
Cellular and Cordless Phones  
Wireless Local Loop  
IEEE-802.11 and Wireless Data

*Typical Operating Circuit appears at end of data sheet.*

**Features**

- ◆ 400MHz to 2.5GHz Operation
- ◆ +2.7V to +5.5V Single-Supply Operation
- ◆ Low Noise Figure: 6.3dB at 900MHz (MAX2680)
- ◆ High Input Third-Order Intercept Point (IIP3 at 2450MHz)
  - 6.9dBm at 5.0mA (MAX2680)
  - +1.0dBm at 8.7mA (MAX2681)
  - +3.2dBm at 15.0mA (MAX2682)
- ◆ <0.1µA Low-Power Shutdown Mode
- ◆ Ultra-Small Surface-Mount Packaging

**Ordering Information**

PART	TEMP RANGE	PIN-PACKAGE	SOT TOP MARK
MAX2680EUT-T	-40°C to +85°C	6 SOT23-6	AAAR
MAX2681EUT-T	-40°C to +85°C	6 SOT23-6	AAAS
MAX2682EUT-T	-40°C to +85°C	6 SOT23-6	AAAT

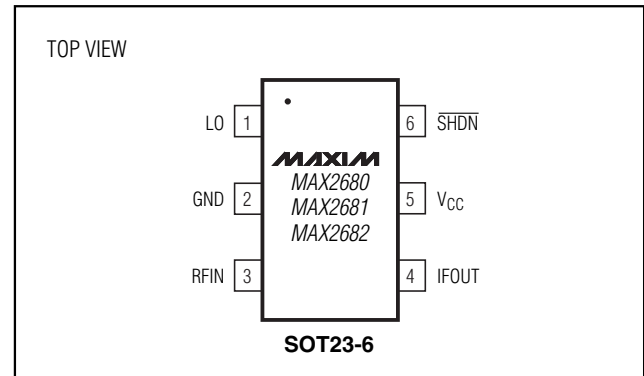
**Pin Configuration****Selector Guide**

PART	I <sub>CC</sub> (mA)	FREQUENCY								
		900MHz			1950MHz			2450MHz		
		IIP3 (dBm)	NF (dB)	GAIN (dB)	IIP3 (dBm)	NF (dB)	GAIN (dB)	IIP3 (dBm)	NF (dB)	GAIN (dB)
MAX2680	5.0	-12.9	6.3	11.6	-8.2	8.3	7.6	-6.9	11.7	7.0
MAX2681	8.7	-6.1	7.0	14.2	+0.5	11.1	8.4	+1.0	12.7	7.7
MAX2682	15.0	-1.8	6.5	14.7	+4.4	10.2	10.4	+3.2	13.4	7.9

**MAXIM**

Maxim Integrated Products 1

**For free samples & the latest literature: <http://www.maxim-ic.com>, or phone 1-800-998-8800.  
For small orders, phone 1-800-835-8769.**

MAX2680/MAX2681/MAX2682

# 400MHz to 2.5GHz, Low-Noise, SiGe Downconverter Mixers

## ABSOLUTE MAXIMUM RATINGS

V <sub>CC</sub> to GND .....	-0.3V to +6.0V	Continuous Power Dissipation (T <sub>A</sub> = +70°C)	
RFIN Input Power (50Ω Source).....	+10dBm	SOT23-6 (derate 8.7mW/°C above +70°C).....	696mW
LO Input Power (50Ω Source).....	+10dBm	Operating Temperature Range .....	-40°C to +85°C
SHDN, IFOUT, RFIN to GND .....	-0.3V to (V <sub>CC</sub> + 0.3V)	Junction Temperature .....	+150°C
LO to GND.....	(V <sub>CC</sub> - 1V) to (V <sub>CC</sub> + 0.3V)	Storage Temperature Range .....	-65°C to +160°C
		Lead Temperature (soldering, 10s) .....	+300°C

Stresses beyond those listed under "Absolute Maximum Ratings" may cause permanent damage to the device. These are stress ratings only, and functional operation of the device at these or any other conditions beyond those indicated in the operational sections of the specifications is not implied. Exposure to absolute maximum rating conditions for extended periods may affect device reliability.



**CAUTION!** ESD SENSITIVE DEVICE

## DC ELECTRICAL CHARACTERISTICS

(V<sub>CC</sub> = +2.7V to +5.5V, SHDN = +2V, T<sub>A</sub> = T<sub>MIN</sub> to T<sub>MAX</sub> unless otherwise noted. Typical values are at V<sub>CC</sub> = +3V and T<sub>A</sub> = +25°C. Minimum and maximum values are guaranteed over temperature by design and characterization.)

PARAMETER	SYMBOL	CONDITIONS	MIN	TYP	MAX	UNITS
Operating Supply Current	I <sub>CC</sub>	MAX2680		5.0	7.7	mA
		MAX2681		8.7	12.7	
		MAX2682		15.0	21.8	
Shutdown Supply Current	I <sub>CC</sub>	SHDN = 0.5V		0.05	5	μA
Shutdown Input Voltage High	V <sub>IH</sub>		2.0			V
Shutdown Input Voltage Low	V <sub>IL</sub>				0.5	V
Shutdown Input Bias Current	I <sub>SHDN</sub>	0 < SHDN < V <sub>CC</sub>		0.2		μA

## AC ELECTRICAL CHARACTERISTICS

(MAX2680/1/2 EV Kit, V<sub>CC</sub> = SHDN = +3.0V, T<sub>A</sub> = +25°C, unless otherwise noted. RFIN and IFOUT matched to 50Ω. P<sub>LO</sub> = -5dBm, P<sub>RFIN</sub> = -25dBm.)

PARAMETER	CONDITIONS	MIN	TYP	MAX	UNITS
<b>MAX2680</b>					
RF Frequency Range	(Notes 1, 2)	400		2500	MHz
LO Frequency Range	(Notes 1, 2)	400		2500	MHz
IF Frequency Range	(Notes 1, 2)	10		500	MHz
Conversion Power Gain	f <sub>RF</sub> = 400MHz, f <sub>LO</sub> = 445MHz, f <sub>IF</sub> = 45MHz		7.3		dB
	f <sub>RF</sub> = 900MHz, f <sub>LO</sub> = 970MHz, f <sub>IF</sub> = 70MHz		11.6		
	f <sub>RF</sub> = 1950MHz, f <sub>LO</sub> = 1880MHz, f <sub>IF</sub> = 70MHz (Note 1)	5.7	7.6	8.6	
	f <sub>RF</sub> = 2450MHz, f <sub>LO</sub> = 2210MHz, f <sub>IF</sub> = 240MHz		7.0		
Gain Variation Over Temperature	f <sub>RF</sub> = 1950MHz, f <sub>LO</sub> = 1880MHz, f <sub>IF</sub> = 70MHz, T <sub>A</sub> = T <sub>MIN</sub> to T <sub>MAX</sub> (Note 1)		1.9	2.4	dB
Input Third-Order Intercept Point (Note 3)	f <sub>RF</sub> = 900MHz, 901MHz, f <sub>LO</sub> = 970MHz, f <sub>IF</sub> = 70MHz		-12.9		dBm
	f <sub>RF</sub> = 1950MHz, 1951MHz, f <sub>LO</sub> = 1880MHz, f <sub>IF</sub> = 70MHz		-8.2		
	f <sub>RF</sub> = 2450MHz, 2451MHz, f <sub>LO</sub> = 2210MHz, f <sub>IF</sub> = 240MHz		-6.9		
Noise Figure (Single Sideband)	f <sub>RF</sub> = 900MHz, f <sub>LO</sub> = 970MHz, f <sub>IF</sub> = 70MHz		6.3		dB
	f <sub>RF</sub> = 1950MHz, f <sub>LO</sub> = 2020MHz, f <sub>IF</sub> = 70MHz		8.3		
	f <sub>RF</sub> = 2450MHz, f <sub>LO</sub> = 2210MHz, f <sub>IF</sub> = 240MHz		11.7		
LO Input VSWR	50Ω source impedance		1.5:1		
LO Leakage at IFOUT Port	f <sub>LO</sub> = 1880MHz		-22		dBm

# 400MHz to 2.5GHz, Low-Noise, SiGe Downconverter Mixers

MAX2680/MAX2681/MAX2682

## AC ELECTRICAL CHARACTERISTICS (continued)

(MAX2680/1/2 EV Kit,  $V_{CC} = \overline{\text{SHDN}} = +3.0\text{V}$ ,  $T_A = +25^\circ\text{C}$ , unless otherwise noted. RFIN and IFOUT matched to  $50\Omega$ .  $P_{LO} = -5\text{dBm}$ ,  $P_{RFIN} = -25\text{dBm}$ .)

PARAMETER	CONDITIONS	MIN	TYP	MAX	UNITS
LO Leakage at RFIN Port	$f_{LO} = 1880\text{MHz}$		-26		dBm
IF/2 Spurious Response	$f_{RF} = 1915\text{MHz}$ , $f_{LO} = 1880\text{MHz}$ , $f_{IF} = 70\text{MHz}$ (Note 4)		-51		dBm
<b>MAX2681</b>					
RF Frequency Range	(Notes 1, 2)	400		2500	MHz
LO Frequency Range	(Notes 1, 2)	400		2500	MHz
IF Frequency Range	(Notes 1, 2)	10		500	MHz
Conversion Power Gain	$f_{RF} = 400\text{MHz}$ , $f_{LO} = 445\text{MHz}$ , $f_{IF} = 45\text{MHz}$		11.0		dB
	$f_{RF} = 900\text{MHz}$ , $f_{LO} = 970\text{MHz}$ , $f_{IF} = 70\text{MHz}$		14.2		
	$f_{RF} = 1950\text{MHz}$ , $f_{LO} = 1880\text{MHz}$ , $f_{IF} = 70\text{MHz}$ (Note 1)	6.7	8.4	9.4	
	$f_{RF} = 2450\text{MHz}$ , $f_{LO} = 2210\text{MHz}$ , $f_{IF} = 240\text{MHz}$		7.7		
Gain Variation Over Temperature	$f_{RF} = 1950\text{MHz}$ , $f_{LO} = 1880\text{MHz}$ , $f_{IF} = 70\text{MHz}$ , $T_A = T_{MIN}$ to $T_{MAX}$ (Note 1)		1.7	2.3	dB
Input Third-Order Intercept Point (Note 3)	$f_{RF} = 900\text{MHz}$ , $901\text{MHz}$ , $f_{LO} = 970\text{MHz}$ , $f_{IF} = 70\text{MHz}$		-6.1		dBm
	$f_{RF} = 1950\text{MHz}$ , $1951\text{MHz}$ , $f_{LO} = 1880\text{MHz}$ , $f_{IF} = 70\text{MHz}$		+0.5		
	$f_{RF} = 2450\text{MHz}$ , $2451\text{MHz}$ , $f_{LO} = 2210\text{MHz}$ , $f_{IF} = 240\text{MHz}$		+1.0		
Noise Figure (Single Sideband)	$f_{RF} = 900\text{MHz}$ , $f_{LO} = 970\text{MHz}$ , $f_{IF} = 70\text{MHz}$		7.0		dB
	$f_{RF} = 1950\text{MHz}$ , $f_{LO} = 2020\text{MHz}$ , $f_{IF} = 70\text{MHz}$		11.1		
	$f_{RF} = 2450\text{MHz}$ , $f_{LO} = 2210\text{MHz}$ , $f_{IF} = 240\text{MHz}$		12.7		
LO Input VSWR	$50\Omega$ source impedance		1.5:1		
LO Leakage at IFOUT Port	$f_{LO} = 1880\text{MHz}$		-23		dBm
LO Leakage at RFIN Port	$f_{LO} = 1880\text{MHz}$		-27		dBm
IF/2 Spurious Response	$f_{RF} = 1915\text{MHz}$ , $f_{LO} = 1880\text{MHz}$ , $f_{IF} = 70\text{MHz}$ (Note 4)		-65		dBm
<b>MAX2682</b>					
RF Frequency Range	(Notes 1, 2)	400		2500	MHz
LO Frequency Range	(Notes 1, 2)	400		2500	MHz
IF Frequency Range	(Notes 1, 2)	10		500	MHz
Conversion Power Gain	$f_{RF} = 400\text{MHz}$ , $f_{LO} = 445\text{MHz}$ , $f_{IF} = 45\text{MHz}$		13.4		dB
	$f_{RF} = 900\text{MHz}$ , $f_{LO} = 970\text{MHz}$ , $f_{IF} = 70\text{MHz}$		14.7		
	$f_{RF} = 1950\text{MHz}$ , $f_{LO} = 1880\text{MHz}$ , $f_{IF} = 70\text{MHz}$ (Note 1)	8.7	10.4	11.7	
	$f_{RF} = 2450\text{MHz}$ , $f_{LO} = 2210\text{MHz}$ , $f_{IF} = 240\text{MHz}$		7.9		
Gain Variation Over Temperature	$f_{RF} = 1950\text{MHz}$ , $f_{LO} = 1880\text{MHz}$ , $f_{IF} = 70\text{MHz}$ , $T_A = T_{MIN}$ to $T_{MAX}$ (Note 1)		2.1	3.2	dB
Input Third-Order Intercept Point (Note 3)	$f_{RF} = 900\text{MHz}$ , $901\text{MHz}$ , $f_{LO} = 970\text{MHz}$ , $f_{IF} = 70\text{MHz}$		-1.8		dBm
	$f_{RF} = 1950\text{MHz}$ , $1951\text{MHz}$ , $f_{LO} = 1880\text{MHz}$ , $f_{IF} = 70\text{MHz}$		+4.4		
	$f_{RF} = 2450\text{MHz}$ , $2451\text{MHz}$ , $f_{LO} = 2210\text{MHz}$ , $f_{IF} = 240\text{MHz}$		+3.2		
Noise Figure (Single Sideband)	$f_{RF} = 900\text{MHz}$ , $f_{LO} = 970\text{MHz}$ , $f_{IF} = 70\text{MHz}$		6.5		dB
	$f_{RF} = 1950\text{MHz}$ , $f_{LO} = 2020\text{MHz}$ , $f_{IF} = 70\text{MHz}$		10.2		
	$f_{RF} = 2450\text{MHz}$ , $f_{LO} = 2210\text{MHz}$ , $f_{IF} = 240\text{MHz}$		13.4		

# 400MHz to 2.5GHz, Low-Noise, SiGe Downconverter Mixers

## AC ELECTRICAL CHARACTERISTICS (continued)

(MAX2680/1/2 EV Kit,  $V_{CC} = \overline{\text{SHDN}} = +3.0\text{V}$ ,  $T_A = +25^\circ\text{C}$ , unless otherwise noted.  $R_{FIN}$  and  $I_{FOUT}$  matched to  $50\Omega$ .  $P_{LO} = -5\text{dBm}$ ,  $P_{RFIN} = -25\text{dBm}$ .)

PARAMETER	CONDITIONS	MIN	TYP	MAX	UNITS
LO Input VSWR	$50\Omega$ source impedance		1.5:1		
LO Leakage at IFOUT Port	$f_{LO} = 1880\text{MHz}$		-23		dBm
LO Leakage at RFIN Port	$f_{LO} = 1880\text{MHz}$		-27		dBm
IF/2 Spurious Response	$f_{RF} = 1915\text{MHz}$ , $f_{LO} = 1880\text{MHz}$ , $f_{IF} = 70\text{MHz}$ (Note 4)		-61		dBm

**Note 1:** Guaranteed by design and characterization.

**Note 2:** Operation outside of this specification is possible, but performance is not characterized and is not guaranteed.

**Note 3:** Two input tones at  $-25\text{dBm}$  per tone.

**Note 4:** This spurious response is caused by a higher-order mixing product ( $2 \times 2$ ). Specified RF frequency is applied and IF output power is observed at the desired IF frequency ( $70\text{MHz}$ ).

## Typical Operating Characteristics

(Typical Operating Circuit,  $V_{CC} = \overline{\text{SHDN}} = +3.0\text{V}$ ,  $P_{RFIN} = -25\text{dBm}$ ,  $P_{LO} = -5\text{dBm}$ ,  $T_A = +25^\circ\text{C}$ , unless otherwise noted.)

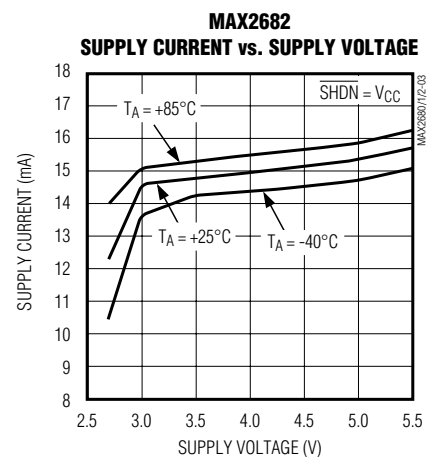
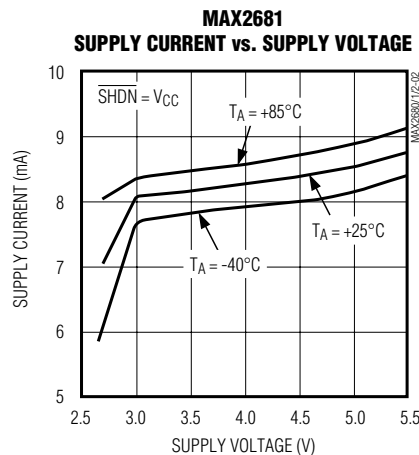
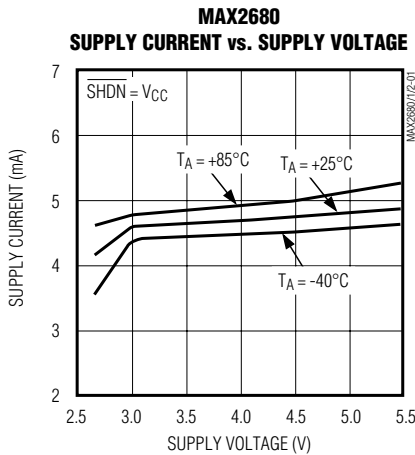

# 400MHz to 2.5GHz, Low-Noise, SiGe Downconverter Mixers

## Typical Operating Characteristics (continued)

(Typical Operating Circuit,  $V_{CC} = \overline{\text{SHDN}} = +3.0\text{V}$ ,  $P_{\text{RFIN}} = -25\text{dBm}$ ,  $P_{\text{LO}} = -5\text{dBm}$ ,  $T_A = +25^\circ\text{C}$ , unless otherwise noted.)

MAX2680/MAX2681/MAX2682

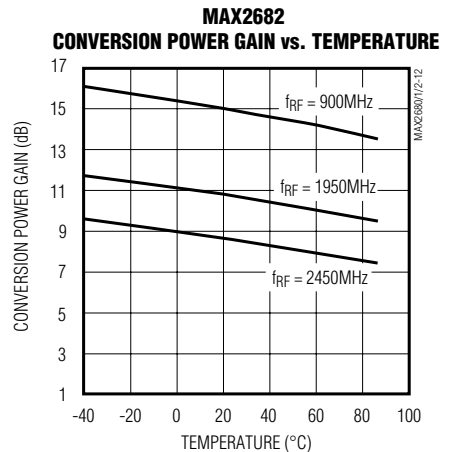
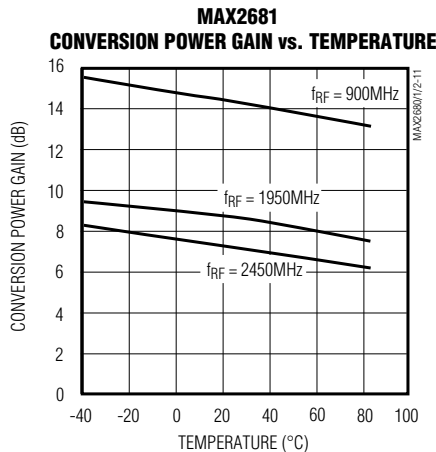
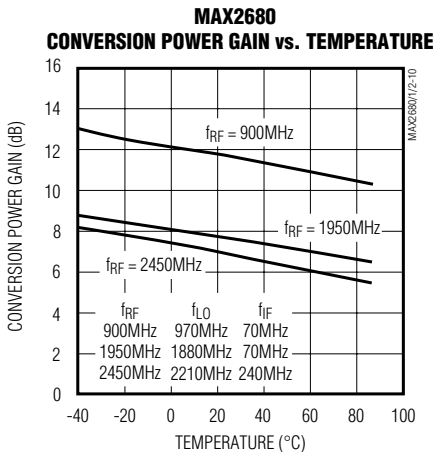
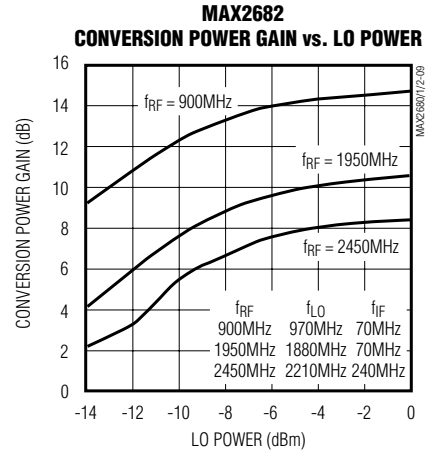
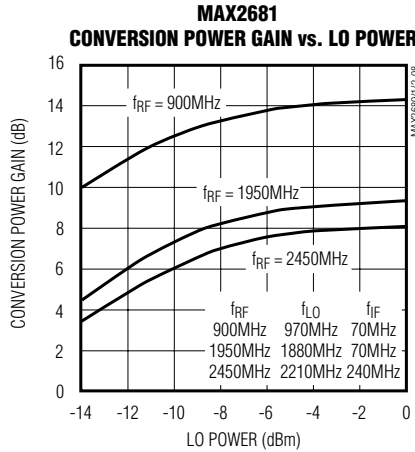
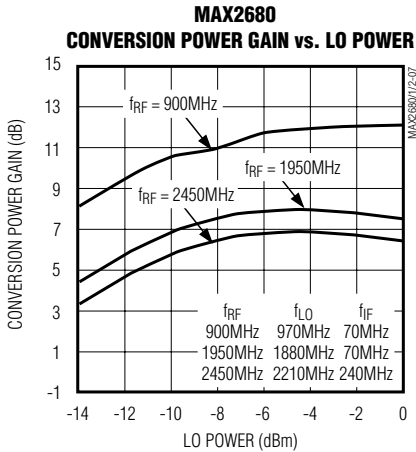
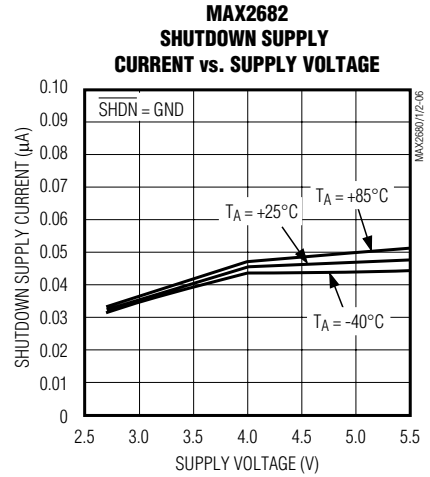
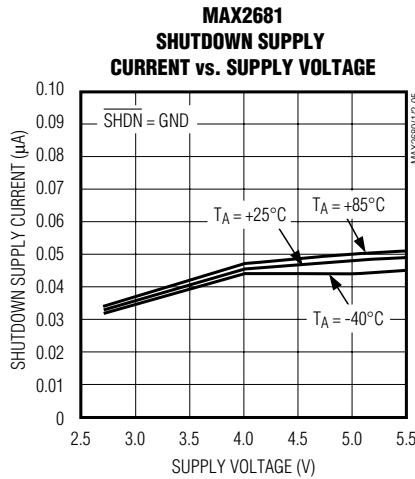
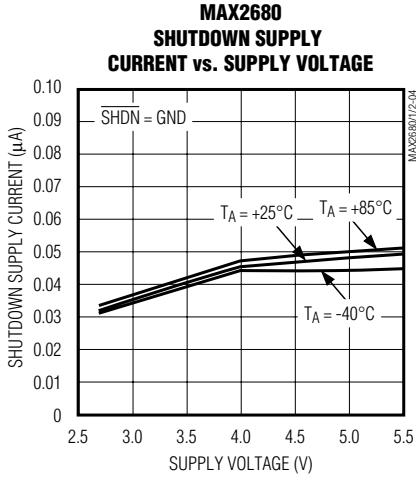

# 400MHz to 2.5GHz, Low-Noise, SiGe Downconverter Mixers

## Typical Operating Characteristics (continued)

(Typical Operating Circuit,  $V_{CC} = \overline{\text{SHDN}} = +3.0\text{V}$ ,  $P_{\text{RFIN}} = -25\text{dBm}$ ,  $P_{\text{LO}} = -5\text{dBm}$ ,  $T_A = +25^\circ\text{C}$ , unless otherwise noted.)

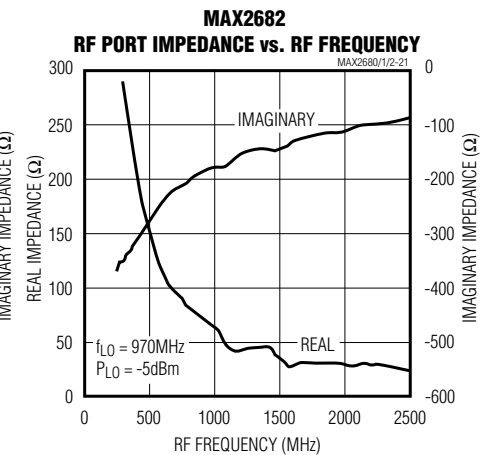
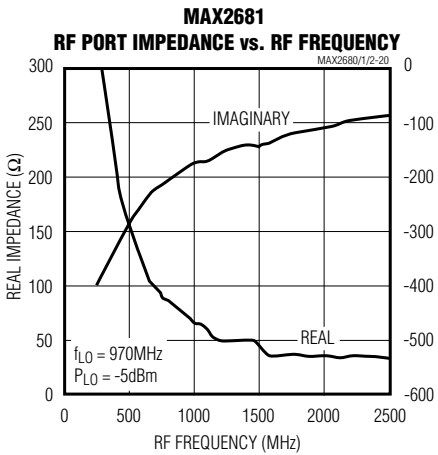
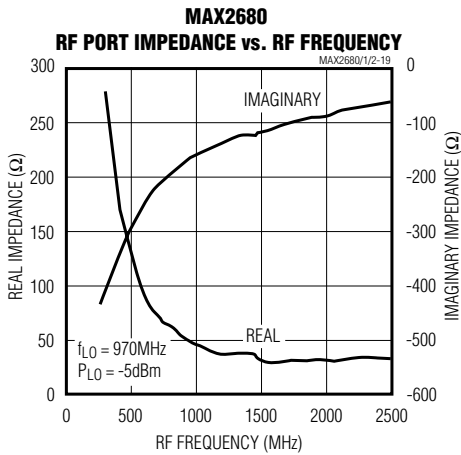
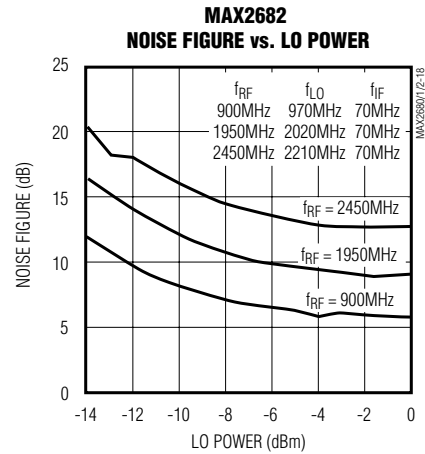
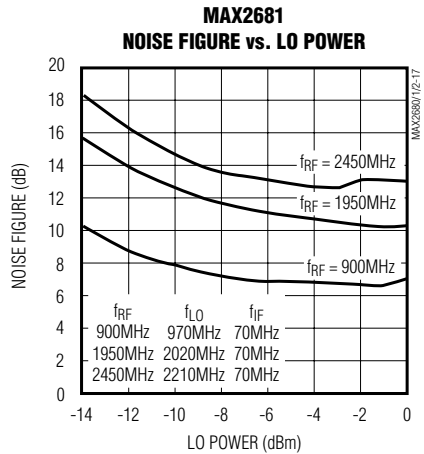
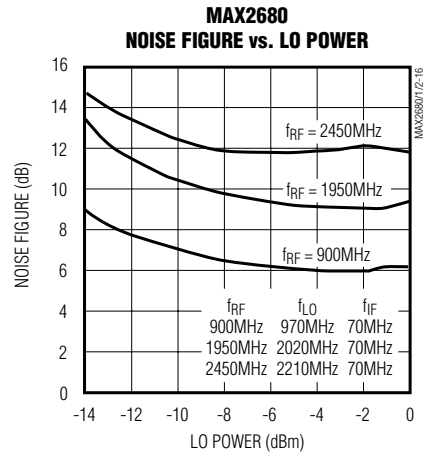
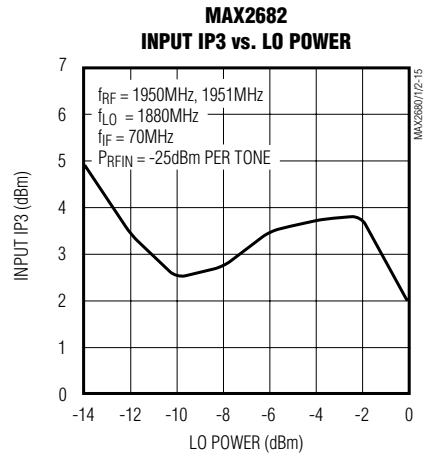
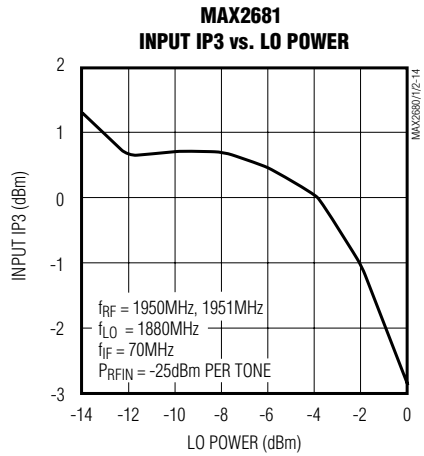
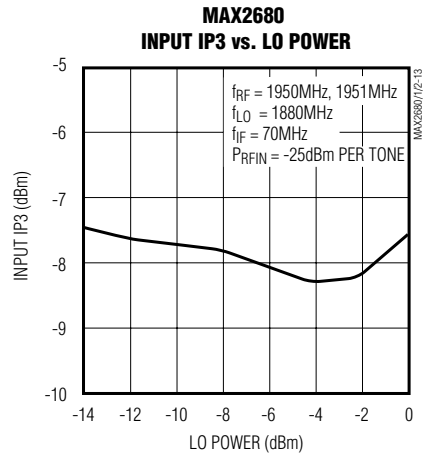

# 400MHz to 2.5GHz, Low-Noise, SiGe Downconverter Mixers

## Typical Operating Characteristics (continued)

(Typical Operating Circuit,  $V_{CC} = \overline{\text{SHDN}} = +3.0\text{V}$ ,  $P_{\text{RFIN}} = -25\text{dBm}$ ,  $P_{\text{LO}} = -5\text{dBm}$ ,  $T_A = +25^\circ\text{C}$ , unless otherwise noted.)

MAX2680/MAX2681/MAX2682

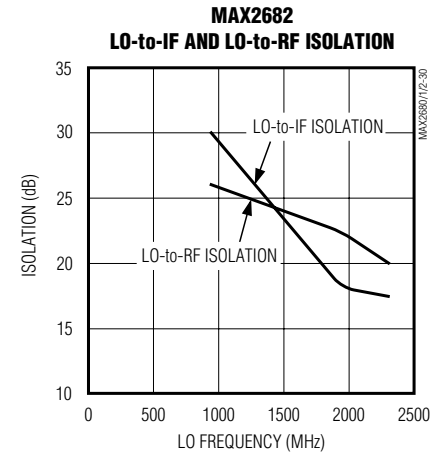
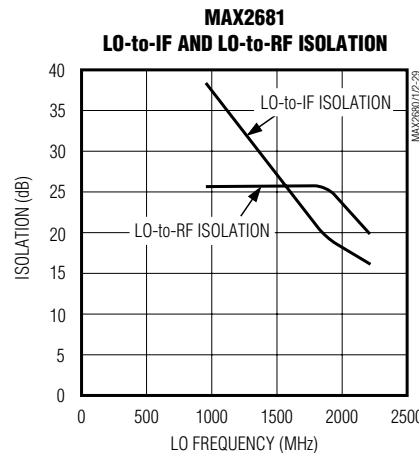
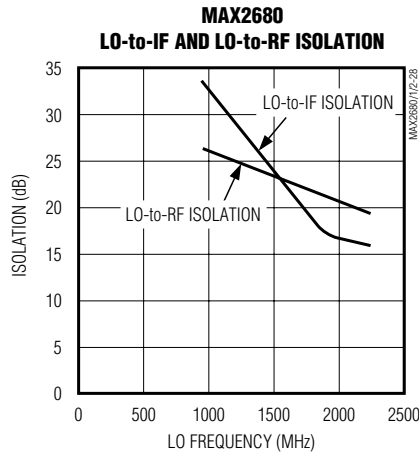
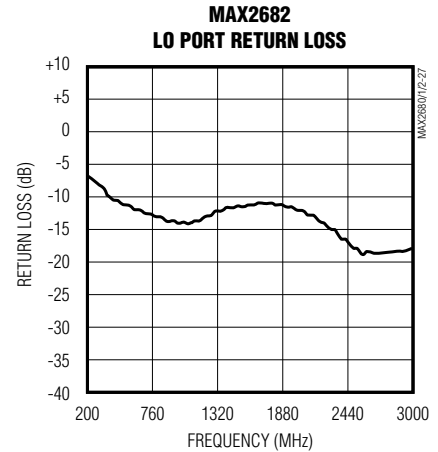
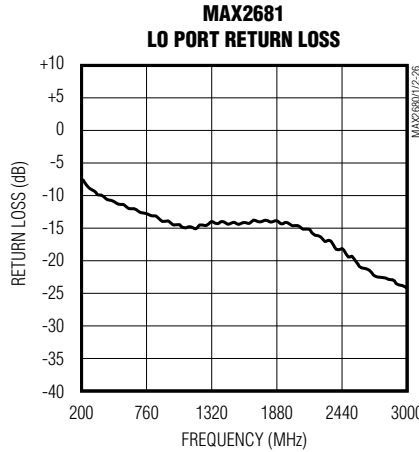
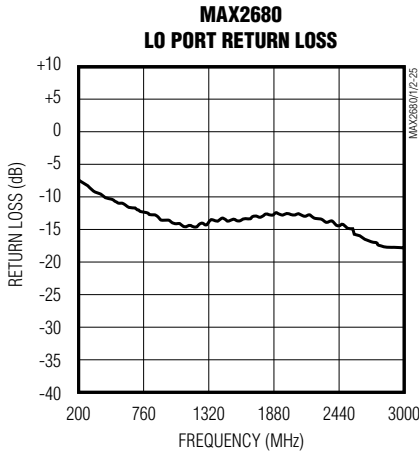
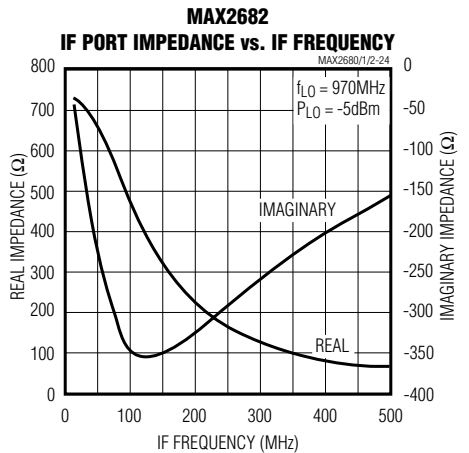
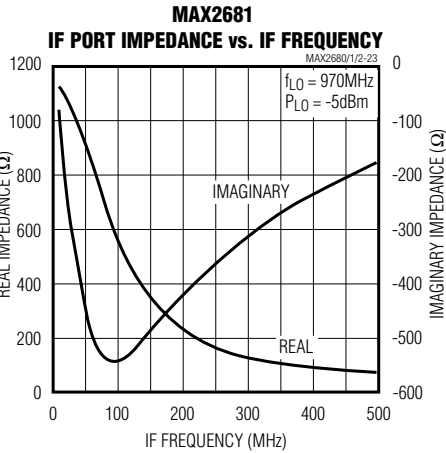
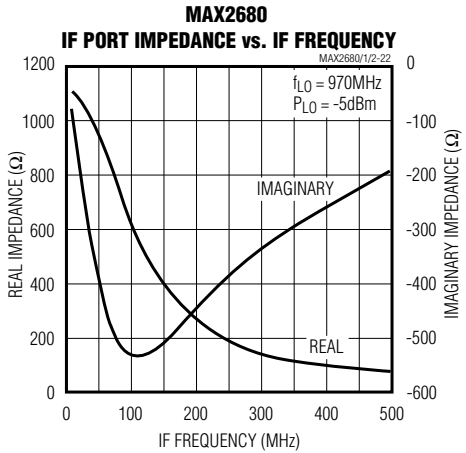

# 400MHz to 2.5GHz, Low-Noise, SiGe Downconverter Mixers

## Typical Operating Characteristics (continued)

(Typical Operating Circuit,  $V_{CC} = \overline{\text{SHDN}} = +3.0\text{V}$ ,  $P_{\text{RFIN}} = -25\text{dBm}$ ,  $P_{\text{LO}} = -5\text{dBm}$ ,  $T_A = +25^\circ\text{C}$ , unless otherwise noted.)

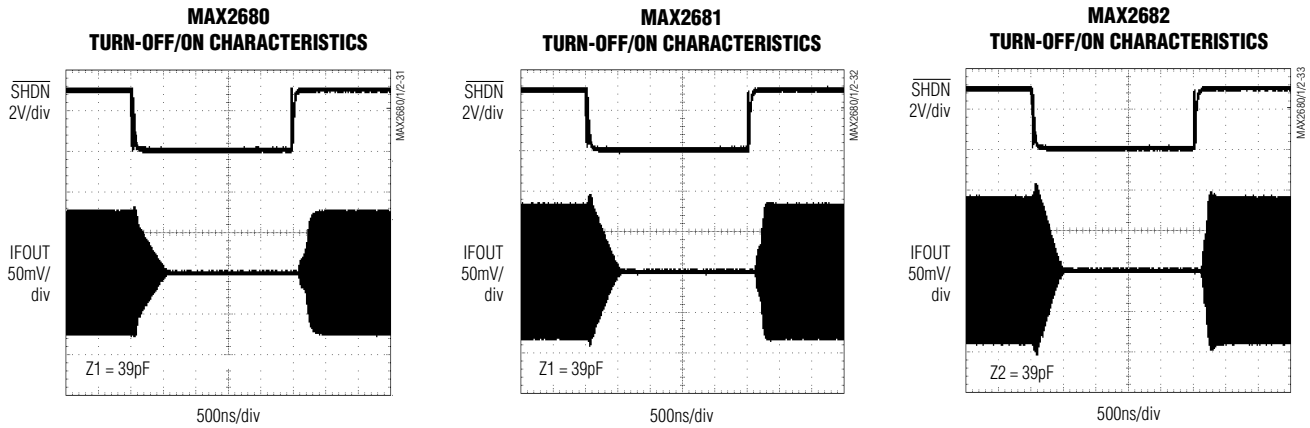

## Pin Description

PIN	NAME	FUNCTION
1	LO	Local-Oscillator Input. Apply a local-oscillator signal with an amplitude of -10dBm to 0 (50Ω source). AC-couple this pin to the oscillator with a DC-blocking capacitor. Nominal DC voltage is $V_{CC} - 0.4\text{V}$ .
2	GND	Mixer Ground. Connect to the ground plane with a low-inductance connection.
3	RFIN	Radio Frequency Input. AC-couple to this pin with a DC-blocking capacitor. Nominal DC voltage is 1.5V. See <i>Applications Information</i> section for details on impedance matching.
4	IFOUT	Intermediate Frequency Output. Open-collector output requires an inductor to $V_{CC}$ . AC-couple to this pin with a DC-blocking capacitor. See <i>Applications Information</i> section for details on impedance matching.
5	$V_{CC}$	Supply Voltage Input, +2.7V to +5.5V. Bypass with a capacitor to the ground plane. Capacitor value depends upon desired operating frequency.
6	$\overline{\text{SHDN}}$	Active-Low Shutdown. Drive low to disable all device functions and reduce the supply current to less than 5μA. For normal operation, drive high or connect to $V_{CC}$ .



# 400MHz to 2.5GHz, Low-Noise, SiGe Downconverter Mixers

MAX2680/MAX2681/MAX2682

## Detailed Description

The MAX2680/MAX2681/MAX2682 are 400MHz to 2.5GHz, silicon-germanium, double-balanced down-converter mixers. They are designed to provide optimum linearity performance for a specified supply current. They consist of a double-balanced Gilbert-cell mixer with single-ended RF, LO, and IF port connections. An on-chip bias cell provides a low-power shut-down feature. Consult the *Selector Guide* for device features and comparison.

## Applications Information

### Local-Oscillator (LO) Input

The LO input is a single-ended broadband port with a typical input VSWR of better than 2.0:1 from 400MHz to 2.5GHz. The LO signal is mixed with the RF input signal, and the resulting downconverted output appears at IFOUT. AC-couple LO with a capacitor. Drive the LO port with a signal ranging from -10dBm to 0 (50Ω source).

### RF Input

The RF input frequency range is 400MHz to 2.5GHz. The RF input requires an impedance-matching network as well as a DC-blocking capacitor that can be part of the matching network. Consult Tables 1 and 2, as well as the RF Port Impedance vs. RF Frequency graph in the *Typical Operating Characteristics* for information on matching.

**Table 1. RFIN Port Impedance**

PART	FREQUENCY			
	400MHz	900MHz	1950MHz	2450MHz
MAX2680	179-j356	54-j179	32-j94	33-j73
MAX2681	209-j332	75-j188	34-j108	33-j86
MAX2682	206-j306	78-j182	34-j106	29-j86

**Table 2. RF Input Impedance-Matching Component Values**

MATCHING COMPONENTS	FREQUENCY											
	MAX2680				MAX2681				MAX2682			
	400 MHz	900 MHz	1950 MHz	2450 MHz	400 MHz	900 MHz	1950 MHz	2450 MHz	400 MHz	900 MHz	1950 MHz	2450 MHz
Z1	86nH	270pF	1.5pF	Short	68nH	270pF	1.5pF	Short	68nH	1.5pF	Short	Short
Z2	270pF	22nH	270pF	270pF	270pF	18nH	270pF	270pF	270pF	270pF	270pF	270pF
Z3	Open	Open	1.8nH	1.8nH	0.5pF	Open	1.8nH	2.2nH	0.5pF	10nH	2.2nH	1.2nH

**Note:** Z1, Z2, and Z3 are found in the *Typical Operating Circuit*.

### IF Output

The IF output frequency range extends from 10MHz to 500MHz. IFOUT is a high-impedance, open-collector output that requires an external inductor to VCC for proper biasing. For optimum performance, the IF port requires an impedance-matching network. The configuration and values for the matching network is dependent upon the frequency and desired output impedance. For assistance in choosing components for optimal performance, refer to Tables 3 and 4 as well as the IF Port Impedance vs. IF Frequency graph in the *Typical Operating Characteristics*.

### Power-Supply and $\overline{\text{SHDN}}$ Bypassing

Proper attention to voltage supply bypassing is essential for high-frequency RF circuit stability. Bypass VCC with a 10μF capacitor in parallel with a 1000pF capacitor. Use separate vias to the ground plane for each of the bypass capacitors and minimize trace length to reduce inductance. Use separate vias to the ground plane for each ground pin. Use low-inductance ground connections.

Decouple  $\overline{\text{SHDN}}$  with a 1000pF capacitor to ground to minimize noise on the internal bias cell. Use a series resistor (typically 100Ω) to reduce coupling of high-frequency signals into the SHDN pin.

### Layout Issues

A well designed PC board is an essential part of an RF circuit. For best performance, pay attention to power-supply issues as well as to the layout of the RFIN and IFOUT impedance-matching network.

# 400MHz to 2.5GHz, Low-Noise, SiGe Downconverter Mixers

**Table 3. IFOUT Port Impedance**

PART	FREQUENCY		
	45MHz	70MHz	240MHz
MAX2680	960-j372	803-j785	186-j397
MAX2681	934-j373	746-j526	161-j375
MAX2682	670-j216	578-j299	175-j296

**Table 4. IF Output Impedance-Matching Components**

MATCHING COMPONENT	FREQUENCY		
	45MHz	70MHz	240MHz
L1	390nH	330nH	82nH
C2	39pF	15pF	3pF
R1	250Ω	Open	Open

**Power-Supply Layout**

To minimize coupling between different sections of the IC, the ideal power-supply layout is a star configuration with a large decoupling capacitor at a central VCC node. The VCC traces branch out from this central node, each going to a separate VCC node on the PC board. At the end of each trace is a bypass capacitor that has low ESR at the RF frequency of operation. This arrangement provides local decoupling at the VCC pin. At high frequencies, any signal leaking out of one supply pin sees a relatively high impedance (formed by the VCC trace inductance) to the central VCC node, and an even higher impedance to any other supply pin, as well as a low impedance to ground through the bypass capacitor.

**Impedance-Matching Network Layout**

The RFIN and IFOUT impedance-matching networks are very sensitive to layout-related parasitics. To minimize parasitic inductance, keep all traces short and place components as close as possible to the chip. To minimize parasitic capacitance, use cutouts in the ground plane (and any other plane) below the matching network components. However, avoid cutouts that are larger than necessary since they act as aperture antennas.

**Typical Operating Circuit**

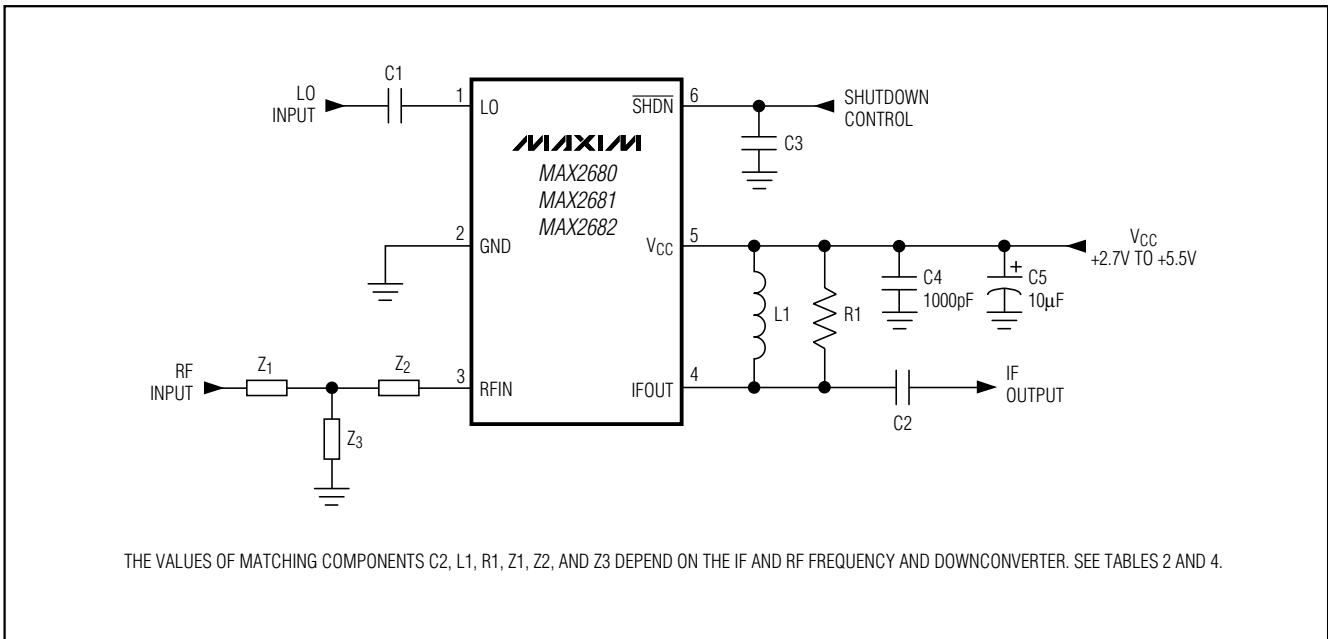

# 400MHz to 2.5GHz, Low-Noise, SiGe Downconverter Mixers

## Package Information

(The package drawing(s) in this data sheet may not reflect the most current specifications. For the latest package outline information go to [www.maxim-ic.com/packages](http://www.maxim-ic.com/packages).)

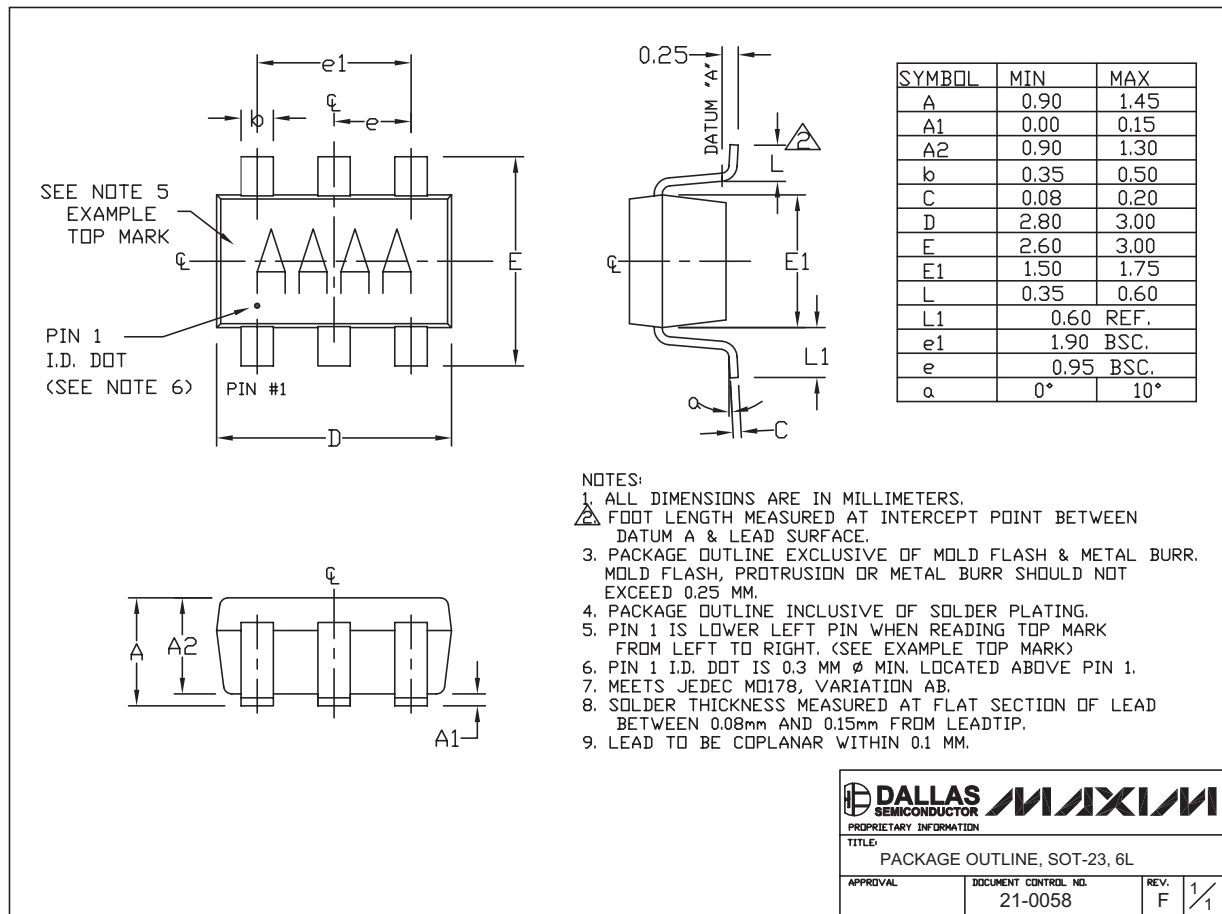

6LSOT.EPS

**DALLAS SEMICONDUCTOR** **MAXIM**  
 PROPRIETARY INFORMATION  
 TITLE: PACKAGE OUTLINE, SOT-23, 6L  
 APPROVAL: \_\_\_\_\_ DOCUMENT CONTROL NO. 21-0058 REV. F 1/1

Maxim cannot assume responsibility for use of any circuitry other than circuitry entirely embodied in a Maxim product. No circuit patent licenses are implied. Maxim reserves the right to change the circuitry and specifications without notice at any time.

**Maxim Integrated Products, 120 San Gabriel Drive, Sunnyvale, CA 94086 408-737-7600** \_\_\_\_\_ **11**

Компания «Океан Электроники» предлагает заключение долгосрочных отношений при поставках импортных электронных компонентов на взаимовыгодных условиях!

Наши преимущества:

- Поставка оригинальных импортных электронных компонентов напрямую с производств Америки, Европы и Азии, а так же с крупнейших складов мира;
- Широкая линейка поставок активных и пассивных импортных электронных компонентов (более 30 млн. наименований);
- Поставка сложных, дефицитных, либо снятых с производства позиций;
- Оперативные сроки поставки под заказ (от 5 рабочих дней);
- Экспресс доставка в любую точку России;
- Помощь Конструкторского Отдела и консультации квалифицированных инженеров;
- Техническая поддержка проекта, помощь в подборе аналогов, поставка прототипов;
- Поставка электронных компонентов под контролем ВП;
- Система менеджмента качества сертифицирована по Международному стандарту ISO 9001;
- При необходимости вся продукция военного и аэрокосмического назначения проходит испытания и сертификацию в лаборатории (по согласованию с заказчиком);
- Поставка специализированных компонентов военного и аэрокосмического уровня качества (Xilinx, Altera, Analog Devices, Intersil, Interpoint, Microsemi, Actel, Aeroflex, Peregrine, VPT, Syfer, Eurofarad, Texas Instruments, MS Kennedy, Miteq, Cobham, E2V, MA-COM, Hittite, Mini-Circuits, General Dynamics и др.);

Компания «Океан Электроники» является официальным дистрибьютором и эксклюзивным представителем в России одного из крупнейших производителей разъемов военного и аэрокосмического назначения «JONHON», а так же официальным дистрибьютором и эксклюзивным представителем в России производителя высокотехнологичных и надежных решений для передачи СВЧ сигналов «FORSTAR».



## JONHON

«JONHON» (основан в 1970 г.)

Разъемы специального, военного и аэрокосмического назначения:

(Применяются в военной, авиационной, аэрокосмической, морской, железнодорожной, горно- и нефтедобывающей отраслях промышленности)

«FORSTAR» (основан в 1998 г.)

ВЧ соединители, коаксиальные кабели, кабельные сборки и микроволновые компоненты:

(Применяются в телекоммуникациях гражданского и специального назначения, в средствах связи, РЛС, а так же военной, авиационной и аэрокосмической отраслях промышленности).



Телефон: 8 (812) 309-75-97 (многоканальный)

Факс: 8 (812) 320-03-32

Электронная почта: [ocean@oceanchips.ru](mailto:ocean@oceanchips.ru)

Web: <http://oceanchips.ru/>

Адрес: 198099, г. Санкт-Петербург, ул. Калинина, д. 2, корп. 4, лит. А