

RoHS Qxx10xx & Qxx10xHx Series



Description

10 Amp bi-directional solid state switch series is designed for AC switching and phase control applications such as motor speed and temperature modulation controls, lighting controls, and static switching relays.

Standard type devices normally operate in Quadrants I & III triggered from AC line.

Features & Benefits

- RoHS Compliant
- Glass – passivated junctions
- Voltage capability up to 1000 V
- Surge capability up to 120 A
- Electrically isolated package "L - Package" and UL recognized for 2500Vrms
- Solid-state switching eliminates arcing or contact bounce that create voltage transients
- No contacts to wear out from reaction of switching events
- Restricted (or limited) RFI generation, depending on activation point sine wave

Agency Approval

Agency	Agency File Number
	L Package: E71639

Main Features

Symbol	Value	Unit
$I_{T(RMS)}$	10	A
V_{DRM}/V_{RRM}	400 to 1000	V
$I_{GT(Q1)}$	25 to 50	mA

Schematic Symbol



Applications

Alternistor type devices are used in applications requiring high commutation performance such as controlling inductive loads. Isolated packages are offered with internal construction, having the case or mounting tab electrically isolated from the semiconductor chip.

Absolute Maximum Ratings — Standard Triac

Symbol	Parameter	Value	Unit		
$I_{T(RMS)}$	RMS on-state current (full sine wave)	Qxx10Ry/ Qxx10Ny	$T_C = 95^\circ\text{C}$	10	A
		Qxx10Ly	$T_C = 90^\circ\text{C}$		
I_{TSM}	Non repetitive surge peak on-state current (full cycle, T_J initial = 25°C)	f = 50 Hz	t = 20 ms	100	A
		f = 60 Hz	t = 16.7 ms	120	
I^2t	I^2t Value for fusing	$t_p = 8.3$ ms		60	A^2s
di/dt	Critical rate of rise of on-state current $I_G = 200\text{mA}$ with $\leq 0.1\mu\text{s}$ rise time	f = 120 Hz	$T_J = 125^\circ\text{C}$	70	$\text{A}/\mu\text{s}$
I_{GTM}	Peak gate trigger current	$t_p \leq 10 \mu\text{s}$ $I_{GT} \leq I_{GTM}$	$T_J = 125^\circ\text{C}$	1.8	A
$P_{G(AV)}$	Average gate power dissipation		$T_J = 125^\circ\text{C}$	0.5	W
T_{stg}	Storage temperature range			-40 to 150	$^\circ\text{C}$
T_J	Operating junction temperature range			-40 to 125	$^\circ\text{C}$

Absolute Maximum Ratings — Alternistor Triac (3 Quadrants)

Symbol	Parameter	Value	Unit		
$I_{T(RMS)}$	RMS on-state current (full sine wave)	Qxx10LHy	$T_C = 90^\circ\text{C}$	10	A
		Qxx10RHy/ Qxx10NHy	$T_C = 95^\circ\text{C}$		
I_{TSM}	Non repetitive surge peak on-state current (full cycle, T_J initial = 25°C)	f = 50 Hz	t = 20 ms	110	A
		f = 60 Hz	t = 16.7 ms	120	
I^2t	I^2t Value for fusing	$t_p = 8.3$ ms		60	A^2s
di/dt	Critical rate of rise of on-state current	f = 120 Hz	$T_J = 125^\circ\text{C}$	70	$\text{A}/\mu\text{s}$
I_{GTM}	Peak gate trigger current	$t_p \leq 10 \mu\text{s}$ $I_{GT} \leq I_{GTM}$	$T_J = 125^\circ\text{C}$	2.0	A
$P_{G(AV)}$	Average gate power dissipation		$T_J = 125^\circ\text{C}$	0.5	W
T_{stg}	Storage temperature range			-40 to 150	$^\circ\text{C}$
T_J	Operating junction temperature range			-40 to 125	$^\circ\text{C}$

Electrical Characteristics ($T_J = 25^\circ\text{C}$, unless otherwise specified) — Standard Triac

Symbol	Test Conditions	Quadrant	Qxx10x4	Qxx10x5	Unit
I_{GT}	$V_D = 12\text{V}$ $R_L = 60 \Omega$	I – II – III IV	25 50	50 75 (TYP)	mA
V_{GT}		I – II – III	1.3		V
V_{GD}	$V_D = V_{DRM}$ $R_L = 3.3 \text{k}\Omega$ $T_J = 125^\circ\text{C}$	ALL	0.2		V
I_H	$I_T = 200\text{mA}$	MAX.	35	50	mA
dv/dt	$V_D = V_{DRM}$ Gate Open $T_J = 125^\circ\text{C}$	400V	150	225	V/ μs
		600V	100	200	
		800V	75	175	
	$V_D = V_{DRM}$ Gate Open $T_J = 100^\circ\text{C}$	1000V	50	150	
(dv/dt)c	(di/dt)c = 5.4 A/ms $T_J = 125^\circ\text{C}$	TYP.	2	4	V/ μs
t_{gt}	$I_G = 2 \times I_{GT}$ PW = 15 μs $I_T = 14.1 \text{A(pk)}$	TYP.	3.0	3.0	μs

Note: xx = voltage, x = package, y = sensitivity

Electrical Characteristics ($T_J = 25^\circ\text{C}$, unless otherwise specified) — Alternistor Triac (3 Quadrants)

Symbol	Test Conditions	Quadrant		Value	Unit
I_{GT}	$V_D = 12\text{V}$ $R_L = 60\ \Omega$	I – II – III	MAX.	50	mA
V_{GT}		I – II – III	MAX.	1.3	V
V_{GD}	$V_D = V_{DRM}$ $R_L = 3.3\ \text{k}\Omega$ $T_J = 125^\circ\text{C}$	I – II – III	MIN.	0.2	V
I_H	$I_T = 100\text{mA}$		MAX.	50	mA
dv/dt	$V_D = V_{DRM}$ Gate Open $T_J = 125^\circ\text{C}$	400V	MIN.	750	V/ μs
		600V		650	
		800V		500	
	$V_D = V_{DRM}$ Gate Open $T_J = 100^\circ\text{C}$	1000V		300	
(dv/dt)c	(di/dt)c = 5.4 A/ms $T_J = 125^\circ\text{C}$		TYP.	30	V/ μs
t_{gt}	$I_G = 2 \times I_{GT}$ $PW = 15\ \mu\text{s}$ $I_T = 14.1\ \text{A(pk)}$		TYP.	4.0	μs

Static Characteristics

Symbol	Test Conditions		Value	Unit	
V_{TM}	$I_{TM} = 14.1\text{A}$ $t_p = 380\ \mu\text{s}$		MAX.	1.60	V
I_{DRM} I_{RRM}	$V_{DRM} = V_{RRM}$	$T_J = 25^\circ\text{C}$	400 - 600V	10	μA
		$T_J = 125^\circ\text{C}$	400 - 800V	2	mA
		$T_J = 100^\circ\text{C}$	1000V	3	

Thermal Resistances

Symbol	Parameter		Value	Unit
$R_{\theta(J-C)}$	Junction to case (AC)	Qxx10Ryy/ Qxx10Nyy	1.3	$^\circ\text{C/W}$
		Qxx10Lyy	2.6	
$R_{\theta(J-A)}$	Junction to ambient (AC)	Qxx10Ryy	45	$^\circ\text{C/W}$
		Qxx10Lyy	50	

Note: xx = voltage, x = package, y = sensitivity, yy = type & sensitivity

Figure 1: Definition of Quadrants

Figure 2: Normalized DC Gate Trigger Current for All Quadrants vs. Junction Temperature

Figure 3: Normalized DC Holding Current vs. Junction Temperature

Figure 4: Normalized DC Gate Trigger Voltage for All Quadrants vs. Junction Temperature

Figure 5: Power Dissipation (Typical) vs. RMS On-State Current

Figure 6: Maximum Allowable Case Temperature vs. On-State Current

Figure 7: Maximum Allowable Ambient Temperature vs. On-State Current



Figure 8: On-State Current vs. On-State Voltage (Typical)

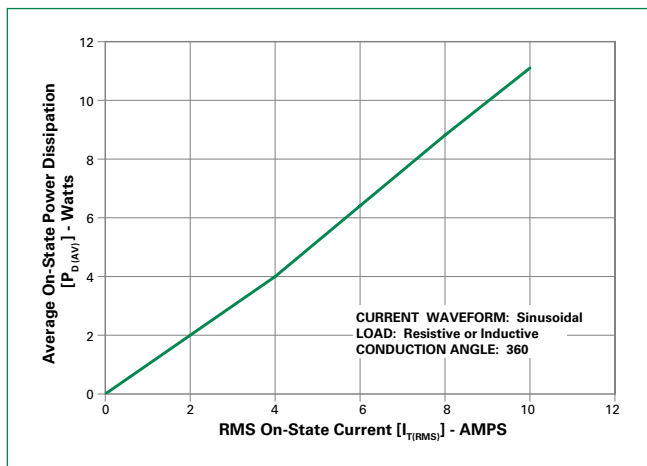
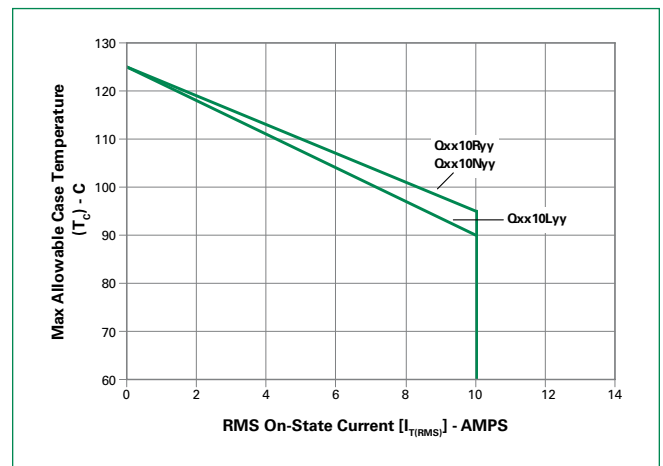
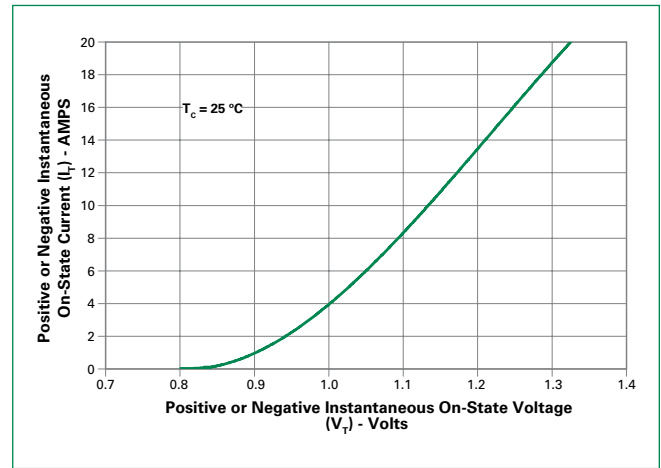

Figure 9: Surge Peak On-State Current vs. Number of Cycles



Soldering Parameters

Reflow Condition		Pb – Free assembly
Pre Heat	- Temperature Min ($T_{s(min)}$)	150°C
	- Temperature Max ($T_{s(max)}$)	200°C
	- Time (min to max) (t_s)	60 – 180 secs
Average ramp up rate (Liquidus Temp (T_L) to peak)		5°C/second max
$T_{s(max)}$ to T_L - Ramp-up Rate		5°C/second max
Reflow	- Temperature (T_L) (Liquidus)	217°C
	- Temperature (t_L)	60 – 150 seconds
Peak Temperature (T_p)		260 ^{+0/-5} °C
Time within 5°C of actual peak Temperature (t_p)		20 – 40 seconds
Ramp-down Rate		5°C/second max
Time 25°C to peak Temperature (T_p)		8 minutes Max.
Do not exceed		280°C



Physical Specifications

Terminal Finish	100% Matte Tin-plated
Body Material	UL recognized epoxy meeting flammability classification 94V-0.
Terminal Material	Copper Alloy

Design Considerations

Careful selection of the correct device for the application's operating parameters and environment will go a long way toward extending the operating life of the Thyristor. Good design practice should limit the maximum continuous current through the main terminals to 75% of the device rating. Other ways to ensure long life for a power discrete semiconductor are proper heat sinking and selection of voltage ratings for worst case conditions. Overheating, overvoltage (including dv/dt), and surge currents are the main killers of semiconductors. Correct mounting, soldering, and forming of the leads also help protect against component damage.

Environmental Specifications

Test	Specifications and Conditions
AC Blocking	MIL-STD-750, M-1040, Cond A Applied Peak AC voltage @ 125°C for 1008 hours
Temperature Cycling	MIL-STD-750, M-1051, 100 cycles; -40°C to +150°C, 15-min dwell-time
Temperature/Humidity	EIA/JEDEC, JESD22-A101 1008 hours; 320V - DC: 85°C; 85% rel humidity
High Temp Storage	MIL-STD-750, M-1031, 1008 hours; 150°C
Low-Temp Storage	1008 hours; -40°C
Thermal Shock	MIL-STD-750, M-1056 10 cycles; 0°C to 100°C; 5-min dwell time at each temperature; 10 sec (max) transfer time between temperature
Autoclave	EIA/JEDEC, JESD22-A102 168 hours (121°C at 2 ATMs) and 100% R/H
Resistance to Solder Heat	MIL-STD-750 Method 2031
Solderability	ANSI/J-STD-002, category 3 Test A
Lead Bend	MIL-STD-750, M-2036 Cond E

Dimensions — TO-220AB (R-Package) — Non-Isolated Mounting Tab Common with Center Lead



Note: Maximum torque to be applied to mounting tab is 8 in-lbs. (0.904 Nm).

Dimension	Inches		Millimeters	
	Min	Max	Min	Max
A	0.380	0.420	9.65	10.67
B	0.105	0.115	2.67	2.92
C	0.230	0.250	5.84	6.35
D	0.590	0.620	14.99	15.75
E	0.142	0.147	3.61	3.73
F	0.110	0.130	2.79	3.30
G	0.540	0.575	13.72	14.61
H	0.025	0.035	0.64	0.89
J	0.195	0.205	4.95	5.21
K	0.095	0.105	2.41	2.67
L	0.060	0.075	1.52	1.91
M	0.085	0.095	2.16	2.41
N	0.018	0.024	0.46	0.61
O	0.178	0.188	4.52	4.78
P	0.045	0.060	1.14	1.52
R	0.038	0.048	0.965	1.22

Dimensions — TO-220AB (L-Package) — Isolated Mounting Tab



Note: Maximum torque to be applied to mounting tab is 8 in-lbs. (0.904 Nm).

Dimension	Inches		Millimeters	
	Min	Max	Min	Max
A	0.380	0.420	9.65	10.67
B	0.105	0.115	2.67	2.92
C	0.230	0.250	5.84	6.35
D	0.590	0.620	14.99	15.75
E	0.142	0.147	3.61	3.73
F	0.110	0.130	2.79	3.30
G	0.540	0.575	13.72	14.61
H	0.025	0.035	0.64	0.89
J	0.195	0.205	4.95	5.21
K	0.095	0.105	2.41	2.67
L	0.060	0.075	1.52	1.91
M	0.085	0.095	2.16	2.41
N	0.018	0.024	0.46	0.61
O	0.178	0.188	4.52	4.78
P	0.045	0.060	1.14	1.52
R	0.038	0.048	0.965	1.22

Dimensions — TO-263AA (N-Package) — D²-PAK Surface Mount



Dimension	Inches		Millimeters	
	Min	Max	Min	Max
A	0.360	0.370	9.14	9.40
B	0.380	0.420	9.65	10.67
C	0.178	0.188	4.52	4.78
D	0.025	0.035	0.64	0.89
E	0.045	0.060	1.14	1.52
F	0.060	0.075	1.52	1.91
G	0.095	0.105	2.41	2.67
H	0.092	0.102	2.34	2.59
J	0.018	0.024	0.46	0.61
K	0.090	0.110	2.29	2.79
S	0.590	0.625	14.99	15.88
V	0.035	0.045	0.89	1.14
U	0.002	0.010	0.05	0.25
W	0.040	0.070	1.016	1.78

Product Selector

Part Number	Voltage (xx)				Gate Sensitivity Quadrants		Type	Package
	400V	600V	800V	1000V	I – II – III	IV		
Qxx10L4	X	X	X	X	25 mA	50 mA	Standard Triac	TO-220L
Qxx10R4	X	X	X	X	25 mA	50 mA	Standard Triac	TO-220R
Qxx10N4	X	X	X	X	25 mA	50 mA	Standard Triac	TO-263 D ² -PAK
Qxx10L5	X	X	X	X	50 mA		Standard Triac	TO-220L
Qxx10R5	X	X	X	X	50 mA		Standard Triac	TO-220R
Qxx10N5	X	X	X	X	50 mA		Standard Triac	TO-263 D ² -PAK
Qxx10LH5	X	X	X	X	50 mA		Alternistor Triac	TO-220L
Qxx10RH5	X	X	X	X	50 mA		Alternistor Triac	TO-220R
Qxx10NH5	X	X	X	X	50 mA		Alternistor Triac	TO-263 D ² -PAK

Packing Options

Part Number	Marking	Weight	Packing Mode	Base Quantity
Qxx10L/Ryy	Qxx10L/Ryy	2.2 g	Bulk	500
Qxx10L/RyyTP	Qxx10L/Ryy	2.2 g	Tube Pack	500 (50 per tube)
Qxx10NyyTP	Qxx10Nyy	1.6 g	Tube	500 (50 per tube)
Qxx10NyyRP	Qxx10Nyy	1.6 g	Embossed Carrier	500

Note: xx = voltage, yy = type & sensitivity

TO-263 Embossed Carrier Reel Pack (RP) Specifications

Meets all EIA-481-2 Standards



Part Numbering System



Part Marking System

TO-220 AB – (R Package)
TO-263 AB – (N Package)



TO-220 AB – (L Package)

Компания «Океан Электроники» предлагает заключение долгосрочных отношений при поставках импортных электронных компонентов на взаимовыгодных условиях!

Наши преимущества:

- Поставка оригинальных импортных электронных компонентов напрямую с производств Америки, Европы и Азии, а так же с крупнейших складов мира;
- Широкая линейка поставок активных и пассивных импортных электронных компонентов (более 30 млн. наименований);
- Поставка сложных, дефицитных, либо снятых с производства позиций;
- Оперативные сроки поставки под заказ (от 5 рабочих дней);
- Экспресс доставка в любую точку России;
- Помощь Конструкторского Отдела и консультации квалифицированных инженеров;
- Техническая поддержка проекта, помощь в подборе аналогов, поставка прототипов;
- Поставка электронных компонентов под контролем ВП;
- Система менеджмента качества сертифицирована по Международному стандарту ISO 9001;
- При необходимости вся продукция военного и аэрокосмического назначения проходит испытания и сертификацию в лаборатории (по согласованию с заказчиком);
- Поставка специализированных компонентов военного и аэрокосмического уровня качества (Xilinx, Altera, Analog Devices, Intersil, Interpoint, Microsemi, Actel, Aeroflex, Peregrine, VPT, Syfer, Eurofarad, Texas Instruments, MS Kennedy, Miteq, Cobham, E2V, MA-COM, Hittite, Mini-Circuits, General Dynamics и др.);

Компания «Океан Электроники» является официальным дистрибьютором и эксклюзивным представителем в России одного из крупнейших производителей разъемов военного и аэрокосмического назначения «JONHON», а так же официальным дистрибьютором и эксклюзивным представителем в России производителя высокотехнологичных и надежных решений для передачи СВЧ сигналов «FORSTAR».



JONHON

«JONHON» (основан в 1970 г.)

Разъемы специального, военного и аэрокосмического назначения:

(Применяются в военной, авиационной, аэрокосмической, морской, железнодорожной, горно- и нефтедобывающей отраслях промышленности)

«FORSTAR» (основан в 1998 г.)

ВЧ соединители, коаксиальные кабели, кабельные сборки и микроволновые компоненты:

(Применяются в телекоммуникациях гражданского и специального назначения, в средствах связи, РЛС, а так же военной, авиационной и аэрокосмической отраслях промышленности).



Телефон: 8 (812) 309-75-97 (многоканальный)

Факс: 8 (812) 320-03-32

Электронная почта: ocean@oceanchips.ru

Web: <http://oceanchips.ru/>

Адрес: 198099, г. Санкт-Петербург, ул. Калинина, д. 2, корп. 4, лит. А