

## Quad SPST CMOS Analog Switches

### DESCRIPTION

The DG441, DG442 monolithic quad analog switches are designed to provide high speed, low error switching of analog and audio signals. The DG441 has a normally closed function. The DG442 has a normally open function. Combining low on-resistance (50  $\Omega$ , typ.) with high speed ( $t_{ON}$  150 ns, typ.), the DG441, DG442 are ideally suited for upgrading DG201A/202 sockets. Charge injection has been minimized on the drain for use in sample-and-hold circuits.

To achieve high voltage ratings and superior switching performance, the DG441, DG442 are built on Vishay Siliconix's high-voltage silicon-gate process. An epitaxial layer prevents latchup.

Each switch conducts equally well in both directions when on, and blocks input voltages to the supply levels when off.

### FEATURES

- **Halogen-free according to IEC 61249-2-21 Definition**
- Low on-resistance: 50  $\Omega$
- Low leakage: 80 pA
- Low power consumption: 0.2 mW
- Fast switching action -  $t_{ON}$ : 150 ns
- Low charge injection - Q: - 1 pC
- DG201A/DG202 upgrades
- TTL/CMOS-compatible logic
- Single supply capability
- **Compliant to RoHS Directive 2002/95/EC**



**RoHS**  
COMPLIANT  
HALOGEN  
**FREE**

### BENEFITS

- Less signal errors and distortion
- Reduced power supply requirements
- Faster throughput
- Improved reliability
- Reduced pedestal errors
- Simplifies retrofit
- Simple interfacing

### APPLICATIONS

- Audio switching
- Battery powered systems
- Data acquisition
- Hi-Rel systems
- Sample-and-hold circuits
- Communication systems
- Automatic test equipment
- Medical instruments

### FUNCTIONAL BLOCK DIAGRAM AND PIN CONFIGURATION



### TRUTH TABLE

Logic	DG441	DG442
0	On	Off
1	Off	On

Logic "0"  $\leq$  0.8 V

Logic "1"  $\geq$  2.4 V

ORDERING INFORMATION		
Temp. Range	Package	Part Number
- 40 °C to 85 °C	16-pin plastic DIP	DG441DJ DG441DJ-E3
		DG442DJ DG442DJ-E3
	16-pin narrow SOIC	DG441DY DG441DY-E3 DG441DY-T1 DG441DY-T1-E3
		DG442DY DG442DY-E3 DG442DY-T1 DG442DY-T1-E3

ABSOLUTE MAXIMUM RATINGS			
Parameter		Limit	Unit
V+ to V-		44	V
GND to V-		25	
Digital Inputs <sup>a</sup> , V <sub>S</sub> , V <sub>D</sub>		(V-) - 2 to (V+) + 2 or 30 mA, whichever occurs first	
Continuous Current (any terminal)		30	mA
Current, S or D (pulsed at 1 ms, 10 % duty cycle)		100	
Storage Temperature	(AK suffix)	- 65 to 150	°C
	(DJ, DY suffix)	- 65 to 125	
Power Dissipation (Package) <sup>b</sup>	16-pin plastic DIP <sup>c</sup>	450	mW
	16-pin CerDIP <sup>d</sup>	900	
	16-pin narrow SOIC <sup>d</sup>	900	
	LCC-20 <sup>d</sup>	1200	

Notes:

- a. Signals on S<sub>X</sub>, D<sub>X</sub>, or IN<sub>X</sub> exceeding V+ or V- will be clamped by internal diodes. Limit forward diode current to maximum current ratings.
- b. All leads welded or soldered to PC board.
- c. Derate 6 mW/°C above 75 °C.
- d. Derate 12 mW/°C above 75 °C.

### SCHEMATIC DIAGRAM Typical Channel



Figure 1.



SPECIFICATIONS <sup>a</sup> (Dual Supplies)										
Parameter	Symbol	Test Conditions Unless Otherwise Specified V <sub>+</sub> = 15 V, V <sub>-</sub> = - 15 V V <sub>IN</sub> = 2.4 V, 0.8 V <sup>f</sup>	Temp. <sup>b</sup>	Typ. <sup>c</sup>	A Suffix - 55 °C to 125 °C		D Suffix - 40 °C to 85 °C		Unit	
					Min. <sup>d</sup>	Max. <sup>d</sup>	Min. <sup>d</sup>	Max. <sup>d</sup>		
<b>Analog Switch</b>										
Analog Signal Range <sup>e</sup>	V <sub>ANALOG</sub>		Full		- 15	15	- 15	15	V	
Drain-Source On-Resistance	R <sub>DS(on)</sub>	I <sub>S</sub> = - 10 mA, V <sub>D</sub> = ± 8.5 V V <sub>+</sub> = 13.5 V, V <sub>-</sub> = - 13.5 V	Room Full	50		85 100		85 100	Ω	
On-Resistance Match Between Channels <sup>e</sup>	ΔR <sub>DS(on)</sub>	I <sub>S</sub> = - 10 mA, V <sub>D</sub> = ± 10 V V <sub>+</sub> = 15 V, V <sub>-</sub> = - 15 V	Room Full			4 5		4 5		
Switch Off Leakage Current	I <sub>S(off)</sub>	V <sub>+</sub> = 16.5 V, V <sub>-</sub> = - 16.5 V	Room Full	± 0.01	- 0.5 - 20	0.5 20	- 0.5 - 5	0.5 5	nA	
	I <sub>D(off)</sub>	V <sub>D</sub> = ± 15.5 V, V <sub>S</sub> = ± 15.5 V	Room Full	± 0.01	- 0.5 - 20	0.5 20	- 0.5 - 5	0.5 5		
Channel On Leakage Current	I <sub>D(on)</sub>	V <sub>+</sub> = 16.5 V, V <sub>-</sub> = - 16.5 V V <sub>S</sub> = V <sub>D</sub> = ± 15.5 V	Room Full	± 0.08	- 0.5 - 40	0.5 40	- 0.5 - 10	0.5 10		
<b>Digital Control</b>										
Input Current V <sub>IN</sub> Low	I <sub>IL</sub>	V <sub>IN</sub> under test = 0.8 V, All Other = 2.4 V	Full	- 0.01	- 500	500	- 500	500	nA	
Input Current V <sub>IN</sub> High	I <sub>IH</sub>	V <sub>IN</sub> under test = 2.4 V All Other = 0.8 V	Full	0.01	- 500	500	- 500	500		
<b>Dynamic Characteristics</b>										
Turn-On Time	t <sub>ON</sub>	R <sub>L</sub> = 1 kΩ, C <sub>L</sub> = 35 pF V <sub>S</sub> = ± 10 V See Figure 2	Room	150		250		250	ns	
Turn-Off Time	DG441 DG442		t <sub>OFF</sub>	Room	90		120			120
				Room	110		210			210
Charge Injection <sup>e</sup>	Q	C <sub>L</sub> = 1 nF, V <sub>S</sub> = 0 V V <sub>gen</sub> = 0 V, R <sub>gen</sub> = 0 Ω	Room	- 1					pC	
Off Isolation <sup>e</sup>	OIRR	R <sub>L</sub> = 50 Ω, C <sub>L</sub> = 5 pF f = 1 MHz	Room	60					dB	
Crosstalk (Channel-to-Channel)	X <sub>TALK</sub>		Room	100						
Source Off Capacitance <sup>e</sup>	C <sub>S(off)</sub>	f = 1 MHz	Room	4					pF	
Drain Off Capacitance <sup>e</sup>	C <sub>D(off)</sub>		Room	4						
Channel On Capacitance <sup>e</sup>	C <sub>D(on)</sub>		V <sub>ANALOG</sub> = 0 V	Room	16					
<b>Power Supplies</b>										
Positive Supply Current	I <sub>+</sub>	V <sub>+</sub> = 16.5 V, V <sub>-</sub> = - 16.5 V V <sub>IN</sub> = 0 or 5 V	Full	15		100		100	μA	
Negative Supply Current	I <sub>-</sub>		Room	- 0.0001	- 1		- 1			
			Full		- 5		- 5			
Ground Current	I <sub>GND</sub>		Full	- 15	- 100		- 100			



<b>SPECIFICATIONS<sup>a</sup></b> (Single Supply)									
Parameter	Symbol	Test Conditions Unless Otherwise Specified $V_+ = 12\text{ V}, V_- = 0\text{ V}$ $V_{IN} = 2.4\text{ V}, 0.8\text{ V}^f$	Temp. <sup>b</sup>	Typ. <sup>c</sup>	A Suffix - 55 °C to 125 °C		D Suffix - 40 °C to 85 °C		Unit
					Min. <sup>d</sup>	Max. <sup>d</sup>	Min. <sup>d</sup>	Max. <sup>d</sup>	
<b>Analog Switch</b>									
Analog Signal Range <sup>e</sup>	$V_{ANALOG}$		Full		0	12	0	12	V
Drain-Source On-Resistance	$R_{DS(on)}$	$I_S = -10\text{ mA}, V_D = 3\text{ V}, 8\text{ V}$ $V_+ = 10.8\text{ V}$	Room Full	100		160 200		160 200	$\Omega$
<b>Dynamic Characteristics</b>									
Turn-On Time	$t_{ON}$	$R_L = 1\text{ k}\Omega, C_L = 35\text{ pF}$ $V_S = 8\text{ V}$ See Figure 2	Room	300		450		450	ns
Turn-Off Time	$t_{OFF}$		Room	60		200		200	
Charge Injection	Q	$C_L = 1\text{ nF}, V_{gen} = 6\text{ V}, R_{gen} = 0\ \Omega$	Room	2					pC
<b>Power Supplies</b>									
Positive Supply Current	$I_+$	$V_+ = 13.2\text{ V}, V_- = 0\text{ V}$ $V_{IN} = 0\text{ or }5\text{ V}$	Full	15		100		100	$\mu\text{A}$
Negative Supply Current	$I_-$		Room	- 0.0001	- 1		- 1		
			Full		- 100		- 100		
Ground Current	$I_{GND}$		Full	- 15	- 100		- 100		

Notes:

- Refer to PROCESS OPTION FLOWCHART.
- Room = 25 °C, Full = as determined by the operating temperature suffix.
- Typical values are for DESIGN AID ONLY, not guaranteed nor subject to production testing.
- The algebraic convention whereby the most negative value is a minimum and the most positive a maximum, is used in this datasheet.
- Guaranteed by design, not subject to production test.
- $V_{IN}$  = input voltage to perform proper function.

Stresses beyond those listed under "Absolute Maximum Ratings" may cause permanent damage to the device. These are stress ratings only, and functional operation of the device at these or any other conditions beyond those indicated in the operational sections of the specifications is not implied. Exposure to absolute maximum rating conditions for extended periods may affect device reliability.

**TYPICAL CHARACTERISTICS** (25 °C, unless otherwise noted)



**R<sub>DS(on)</sub> vs. V<sub>D</sub> and Power Supply Voltage**



**R<sub>DS(on)</sub> vs. V<sub>D</sub> and Temperature**



**R<sub>DS(on)</sub> vs. V<sub>D</sub> and Unipolar Power Supply Voltage**



**R<sub>DS(on)</sub> vs. V<sub>D</sub> and Temperature (Single 12-V Supply)**



**Crosstalk and Off Isolation vs. Frequency**



**Charge Injection vs. Source Voltage**

## TYPICAL CHARACTERISTICS (25 °C, unless otherwise noted)



**Switching Threshold vs. Supply Voltage**

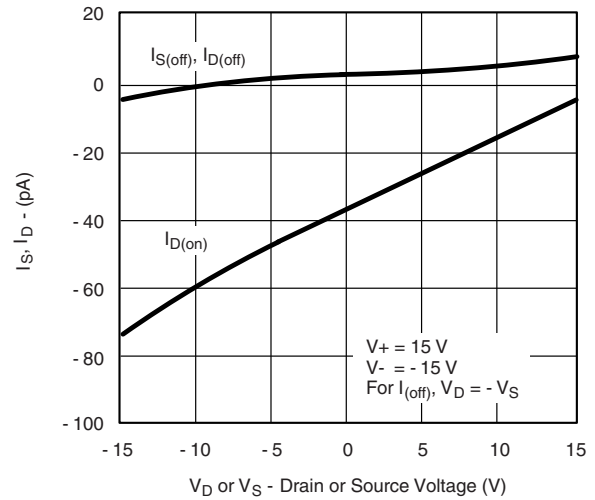

**Source/Drain Leakage Currents**

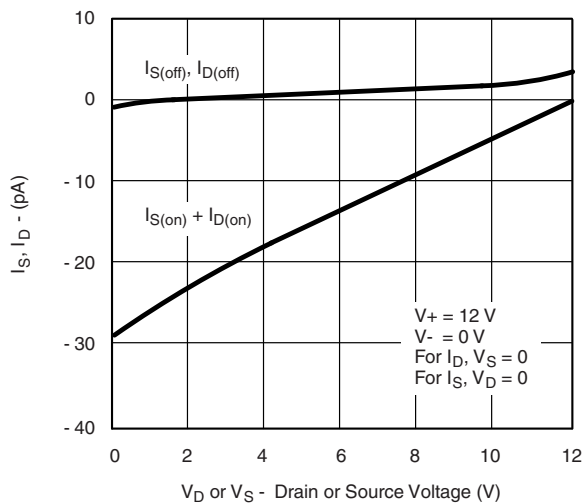

**Source/Drain Leakage Currents (Single 12 V Supply)**

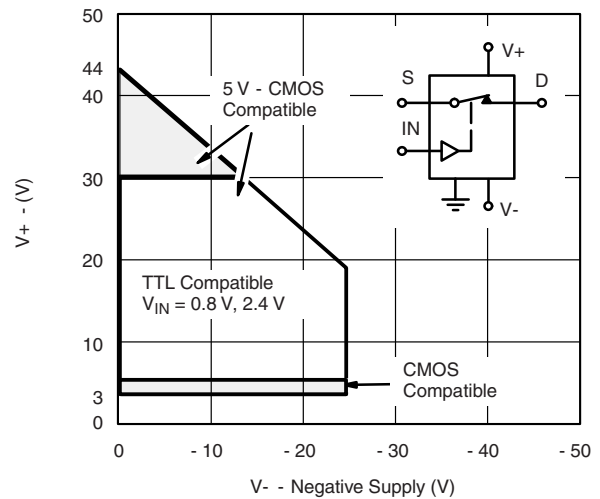

**Operating Voltage**

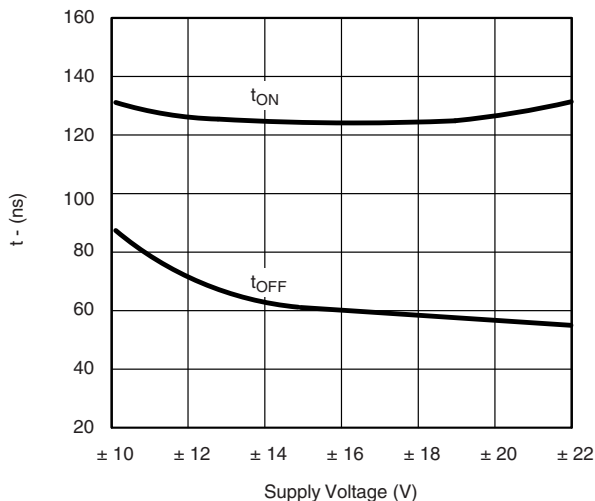

**Switching Time vs. Power Supply Voltage**

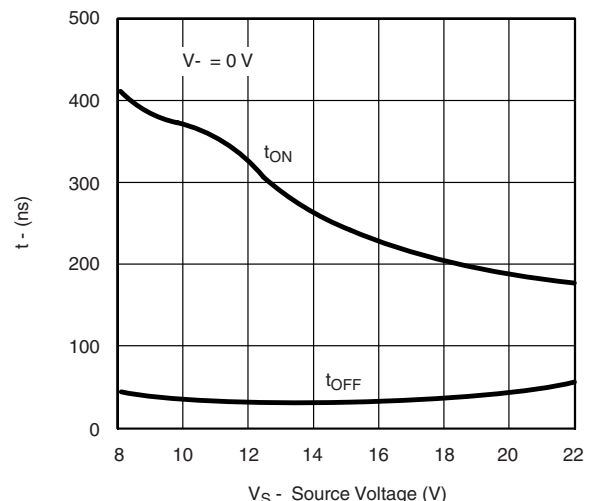

**Switching Time vs. Power Supply Voltage**

## TEST CIRCUITS



$C_L$  (includes fixture and stray capacitance)



Note: Logic input waveform is inverted for DG442.

**Figure 2. Switching Time**

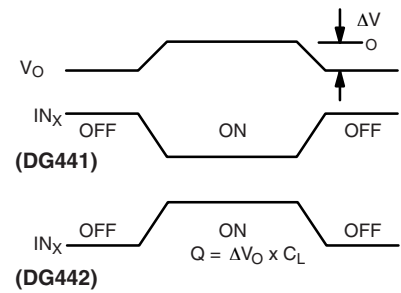

**Figure 3. Charge Injection**

$C = 1 \text{ mF}$  tantalum in parallel with  $0.01 \text{ mF}$  ceramic



$$X_{\text{TALK Isolation}} = 20 \log \left| \frac{V_S}{V_O} \right|$$

$C = \text{RF bypass}$

**Figure 4. Crosstalk**



$$\text{Off Isolation} = 20 \log \left| \frac{V_S}{V_O} \right|$$

**Figure 5. Off Isolation**



**Figure 6. Source/Drain Capacitances**

## APPLICATIONS

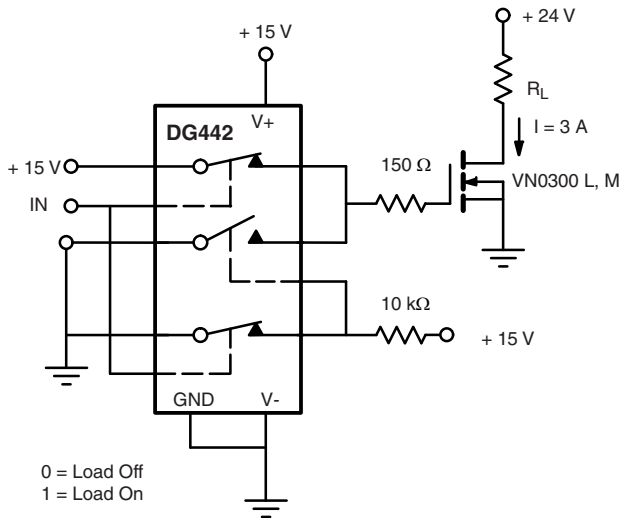

Figure 7. Power MOSFET Driver



Figure 8. Open Loop Sample-and-Hold



Figure 9. Precision-Weighted Resistor Programmable-Gain Amplifier

Vishay Siliconix maintains worldwide manufacturing capability. Products may be manufactured at one of several qualified locations. Reliability data for Silicon Technology and Package Reliability represent a composite of all qualified locations. For related documents such as package/tape drawings, part marking, and reliability data, see [www.vishay.com/ppg?70053](http://www.vishay.com/ppg?70053).





**SOIC (NARROW): 16-LEAD**  
JEDEC Part Number: MS-012



Dim	MILLIMETERS		INCHES	
	Min	Max	Min	Max
A	1.35	1.75	0.053	0.069
A <sub>1</sub>	0.10	0.20	0.004	0.008
B	0.38	0.51	0.015	0.020
C	0.18	0.23	0.007	0.009
D	9.80	10.00	0.385	0.393
E	3.80	4.00	0.149	0.157
e	1.27 BSC		0.050 BSC	
H	5.80	6.20	0.228	0.244
L	0.50	0.93	0.020	0.037
∅	0°	8°	0°	8°

ECN: S-03946—Rev. F, 09-Jul-01  
DWG: 5300



### PDIP: 16-LEAD

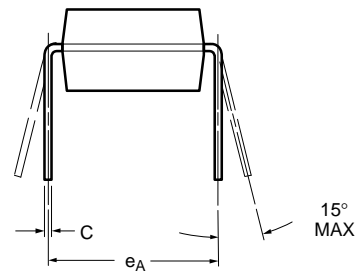

Dim	MILLIMETERS		INCHES	
	Min	Max	Min	Max
<b>A</b>	3.81	5.08	0.150	0.200
<b>A<sub>1</sub></b>	0.38	1.27	0.015	0.050
<b>B</b>	0.38	0.51	0.015	0.020
<b>B<sub>1</sub></b>	0.89	1.65	0.035	0.065
<b>C</b>	0.20	0.30	0.008	0.012
<b>D</b>	18.93	21.33	0.745	0.840
<b>E</b>	7.62	8.26	0.300	0.325
<b>E<sub>1</sub></b>	5.59	7.11	0.220	0.280
<b>e<sub>1</sub></b>	2.29	2.79	0.090	0.110
<b>e<sub>A</sub></b>	7.37	7.87	0.290	0.310
<b>L</b>	2.79	3.81	0.110	0.150
<b>Q<sub>1</sub></b>	1.27	2.03	0.050	0.080
<b>S</b>	0.38	1.52	.015	0.060

ECN: S-03946—Rev. D, 09-Jul-01  
DWG: 5482



**CERDIP: 16-LEAD**



Dim	MILLIMETERS		INCHES	
	Min	Max	Min	Max
A	4.06	5.08	0.160	0.200
A <sub>1</sub>	0.51	1.14	0.020	0.045
B	0.38	0.51	0.015	0.020
B <sub>1</sub>	1.14	1.65	0.045	0.065
C	0.20	0.30	0.008	0.012
D	19.05	19.56	0.750	0.770
E	7.62	8.26	0.300	0.325
E <sub>1</sub>	6.60	7.62	0.260	0.300
e <sub>1</sub>	2.54 BSC		0.100 BSC	
e <sub>A</sub>	7.62 BSC		0.300 BSC	
L	3.18	3.81	0.125	0.150
L <sub>1</sub>	3.81	5.08	0.150	0.200
Q <sub>1</sub>	1.27	2.16	0.050	0.085
S	0.38	1.14	0.015	0.045
∞	0°	15°	0°	15°

ECN: S-03946—Rev. G, 09-Jul-01  
DWG: 5403



**20-LEAD LCC**

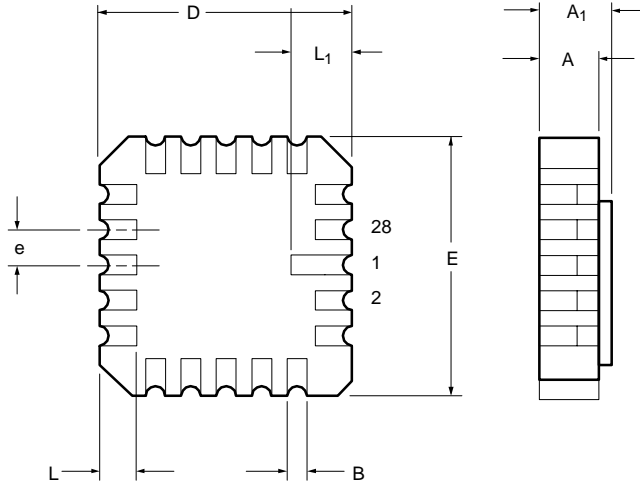

Dim	MILLIMETERS		INCHES	
	Min	Max	Min	Max
<b>A</b>	1.37	2.24	0.054	0.088
<b>A<sub>1</sub></b>	1.63	2.54	0.064	0.100
<b>B</b>	0.56	0.71	0.022	0.028
<b>D</b>	8.69	9.09	0.342	0.358
<b>E</b>	8.69	9.09	0.442	0.358
<b>e</b>	1.27 BSC		0.050 BSC	
<b>L</b>	1.14	1.40	0.045	0.055
<b>L<sub>1</sub></b>	1.96	2.36	0.077	0.093
ECN: S-03946—Rev. B, 09-Jul-01 DWG: 5321				

## RECOMMENDED MINIMUM PADS FOR SO-16



Recommended Minimum Pads  
Dimensions in Inches/(mm)

[Return to Index](#)



## Disclaimer

ALL PRODUCT, PRODUCT SPECIFICATIONS AND DATA ARE SUBJECT TO CHANGE WITHOUT NOTICE TO IMPROVE RELIABILITY, FUNCTION OR DESIGN OR OTHERWISE.

Vishay Intertechnology, Inc., its affiliates, agents, and employees, and all persons acting on its or their behalf (collectively, "Vishay"), disclaim any and all liability for any errors, inaccuracies or incompleteness contained in any datasheet or in any other disclosure relating to any product.

Vishay makes no warranty, representation or guarantee regarding the suitability of the products for any particular purpose or the continuing production of any product. To the maximum extent permitted by applicable law, Vishay disclaims (i) any and all liability arising out of the application or use of any product, (ii) any and all liability, including without limitation special, consequential or incidental damages, and (iii) any and all implied warranties, including warranties of fitness for particular purpose, non-infringement and merchantability.

Statements regarding the suitability of products for certain types of applications are based on Vishay's knowledge of typical requirements that are often placed on Vishay products in generic applications. Such statements are not binding statements about the suitability of products for a particular application. It is the customer's responsibility to validate that a particular product with the properties described in the product specification is suitable for use in a particular application. Parameters provided in datasheets and/or specifications may vary in different applications and performance may vary over time. All operating parameters, including typical parameters, must be validated for each customer application by the customer's technical experts. Product specifications do not expand or otherwise modify Vishay's terms and conditions of purchase, including but not limited to the warranty expressed therein.

Except as expressly indicated in writing, Vishay products are not designed for use in medical, life-saving, or life-sustaining applications or for any other application in which the failure of the Vishay product could result in personal injury or death. Customers using or selling Vishay products not expressly indicated for use in such applications do so at their own risk. Please contact authorized Vishay personnel to obtain written terms and conditions regarding products designed for such applications.

No license, express or implied, by estoppel or otherwise, to any intellectual property rights is granted by this document or by any conduct of Vishay. Product names and markings noted herein may be trademarks of their respective owners.

## Material Category Policy

**Vishay Intertechnology, Inc. hereby certifies that all its products that are identified as RoHS-Compliant fulfill the definitions and restrictions defined under Directive 2011/65/EU of The European Parliament and of the Council of June 8, 2011 on the restriction of the use of certain hazardous substances in electrical and electronic equipment (EEE) - recast, unless otherwise specified as non-compliant.**

**Please note that some Vishay documentation may still make reference to RoHS Directive 2002/95/EC. We confirm that all the products identified as being compliant to Directive 2002/95/EC conform to Directive 2011/65/EU.**

**Vishay Intertechnology, Inc. hereby certifies that all its products that are identified as Halogen-Free follow Halogen-Free requirements as per JEDEC JS709A standards. Please note that some Vishay documentation may still make reference to the IEC 61249-2-21 definition. We confirm that all the products identified as being compliant to IEC 61249-2-21 conform to JEDEC JS709A standards.**

Компания «Океан Электроники» предлагает заключение долгосрочных отношений при поставках импортных электронных компонентов на взаимовыгодных условиях!

Наши преимущества:

- Поставка оригинальных импортных электронных компонентов напрямую с производств Америки, Европы и Азии, а так же с крупнейших складов мира;
- Широкая линейка поставок активных и пассивных импортных электронных компонентов (более 30 млн. наименований);
- Поставка сложных, дефицитных, либо снятых с производства позиций;
- Оперативные сроки поставки под заказ (от 5 рабочих дней);
- Экспресс доставка в любую точку России;
- Помощь Конструкторского Отдела и консультации квалифицированных инженеров;
- Техническая поддержка проекта, помощь в подборе аналогов, поставка прототипов;
- Поставка электронных компонентов под контролем ВП;
- Система менеджмента качества сертифицирована по Международному стандарту ISO 9001;
- При необходимости вся продукция военного и аэрокосмического назначения проходит испытания и сертификацию в лаборатории (по согласованию с заказчиком);
- Поставка специализированных компонентов военного и аэрокосмического уровня качества (Xilinx, Altera, Analog Devices, Intersil, Interpoint, Microsemi, Actel, Aeroflex, Peregrine, VPT, Syfer, Eurofarad, Texas Instruments, MS Kennedy, Miteq, Cobham, E2V, MA-COM, Hittite, Mini-Circuits, General Dynamics и др.);

Компания «Океан Электроники» является официальным дистрибьютором и эксклюзивным представителем в России одного из крупнейших производителей разъемов военного и аэрокосмического назначения «JONHON», а так же официальным дистрибьютором и эксклюзивным представителем в России производителя высокотехнологичных и надежных решений для передачи СВЧ сигналов «FORSTAR».



## JONHON

«JONHON» (основан в 1970 г.)

Разъемы специального, военного и аэрокосмического назначения:

(Применяются в военной, авиационной, аэрокосмической, морской, железнодорожной, горно- и нефтедобывающей отраслях промышленности)

«FORSTAR» (основан в 1998 г.)

ВЧ соединители, коаксиальные кабели, кабельные сборки и микроволновые компоненты:

(Применяются в телекоммуникациях гражданского и специального назначения, в средствах связи, РЛС, а так же военной, авиационной и аэрокосмической отраслях промышленности).



Телефон: 8 (812) 309-75-97 (многоканальный)

Факс: 8 (812) 320-03-32

Электронная почта: [ocean@oceanchips.ru](mailto:ocean@oceanchips.ru)

Web: <http://oceanchips.ru/>

Адрес: 198099, г. Санкт-Петербург, ул. Калинина, д. 2, корп. 4, лит. А