

Proximity Sensors

DC 2-Wire and 3-Wire Models

E2E NEXT Series

9mm

M12 DC 3-wire

Four times the range of
a standard M12 sensor



Exceptional sensing range

Reduces sensor failures
and increases productivity

NEW

IO-Link is standard for NO/PNP 3-wire models

 IO-Link

OMRON

OMRON

E2E NEXT Inductive Sensors
Offer up to four times the range of
standard sensors

9mm

E2E NEXT

Magnetic flux strength

2mm

Previous models * for M12

E2E NEXT

Previous models



The exceptional range offered by the E2E NEXT Sensors allows them to be mounted further away from the intended target. The increased sensing distance reduces the risk of the target impacting the face of the sensor, extending its useful life. Long range sensors:

- Reduce downtime associated with replacing a damaged sensor. The cost of the sensor is minimal compared to the cost of lost production.
- Increases flexibility in mounting design. Use smaller diameter sensors in place of larger diameter sensors.
- Solve difficult applications with additional sensing range. The increased range of the E2E NEXT offers a solution to applications that couldn't be solved before due to lack of sensing range.

E2E NEXT Sensors include a full range of 1x, 2x, 3x, and 4x sensors to meet the needs of any application.

Features

- Up to four times the sensing range of standard inductive sensors
- DC 2-wire and DC 3-wire versions
- Shielded and unshielded versions
- PNP or NPN units (3-wire versions)
- 360° visible output indicator
- -25°C to 70°C operating temperature
- Pre-wired & pre-wired connector models: IP67; IP67G; IP69K
- Connector models: IP67; IP69K
- Short and long body housing options
- Available with splatter resistant coating
- Connection options:
 - Pre-wire PVC
 - Pre-wire Robot PVC
 - PVC pigtail
 - Robot PVC Pigtail
 - M8 3 pin
 - M8 4 pin
 - M12 4pin
- UL, CSA, CE Certifications

Long distance detection reduces failures and improves design flexibility

Reduce sensor damage



Metal plate position confirmation

Previous models

Sliding targets collide with sensors causing failures and equipment downtime.



E2E NEXT

Long-distance detection maintains sufficient target distance from sensor, reducing the risk of impacting the sensor.



* M12

Accommodate changing conditions



Spindle presence detection

Previous models

Equipment vibration widens the distance between target and sensor causing false detection and equipment shutdown.

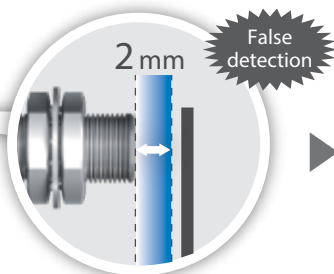

E2E NEXT

Long-distance detection enhances the degree of the detection margin resulting in consistent detection even when the target moves further away from the sensor.

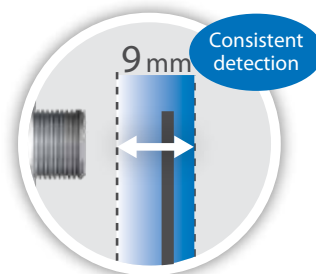

* M12

Increase flexibility in mounting design

The long sensing distance means that smaller sensors can be used for the same tasks, creating more space for additional functionality.

For the space of 50 mm × 50 mm

Previous models The number of sensors is limited due to mutual interference.



E2E NEXT Space-saving Reduce to 30 mm × 30 mm

M12

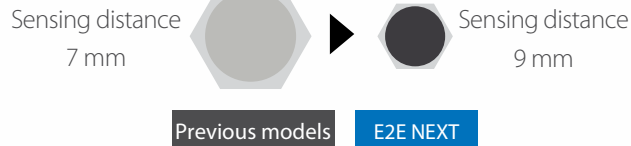
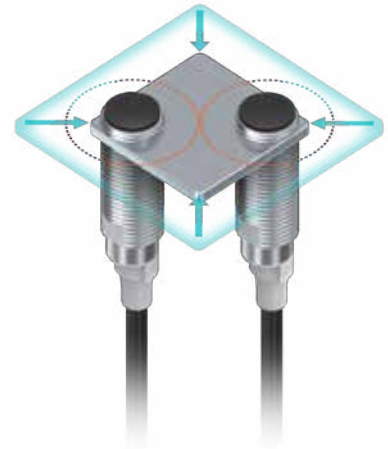

Facilitate installation in tight spaces



Previous models Due to the guide surrounding the welding pin, it is difficult to install a sensor near the pin to check the sitting position.

E2E NEXT Reduced mutual interference allows compact installation in welding jigs.

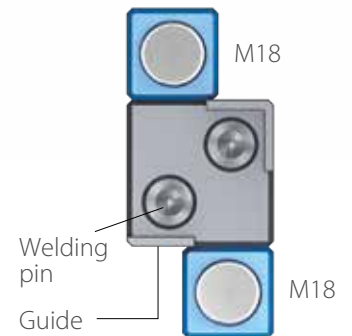

Note: Make sure to factor the influence of surrounding metal into your designs. (Refer to • Influence of Surrounding Metal upon Design in the data sheets for details.)

Unexpected component failures:
Approx. 30% are caused by cutting oil.



2 year oil resistant*1 components reduce unexpected equipment shutdowns

Previous models

Cable deterioration due to cutting oil



PUR cables get cracks in environments where water-soluble cutting oil is used.

Oil resistance: 2 years*1

IP67G	
Oil type	N3 (water-insoluble cutting oil)
Evaluation time	48 hours
Evaluation temperature	Room temperature
Dilution concentration	
Criteria	Appearance and performance

E2E NEXT

Verification of 2-year oil resistance*1 based on IP67G and Omron's oil-resistant component evaluation standards



Omron's E2E NEXT series Proximity Sensor use PVC cables with enhanced oil resistance.

OMRON's Oil-resistant Component Evaluation Standards

Oil type	A1 (water-soluble cutting oil)
Evaluation time	1,000 hours of machining
Evaluation temperature	55 °C
Dilution concentration	Undiluted
Criteria	Appearance, performance, and no label text loss

*1. Applicable oil types: specified in JIS K 2241:2000 "2-year oil resistance" refers to median values (=Typical values) of the product designs and the oil-resistance performance evaluation results. Products to be shipped will have around 2 years of oil resistance; actual oil resistance will vary depending on the product. The pre-wired connector model has a verified oil resistance of 2 years when mated with XS5 NEXT series round oil-resistant connectors. This value has not been verified for 3-wire connector models (M1/M3/M5).

Thermal Distance Control × IoT: technologies for stable long-distance detection

- E2E Next Series Proximity Sensors solve temperature effects on sensing distance with Thermal Distance control (TDC) technology for stable long-distance detection and analog digital hybrid ICs.

DC 2-wire triple distance models (TDC)

- Temperature correction values are written into the analog digital hybrid IC (PROX2) to minimize the influence of temperature changes on sensing distances.

NEW Patent Pending

DC 3-wire quadruple models (TDC × IoT)

- In-line measurements of each sensor's temperature characteristics are possible in IoT-enabled production processes. Optimal correction values then minimize differences the influence of temperature change on sensing distances.

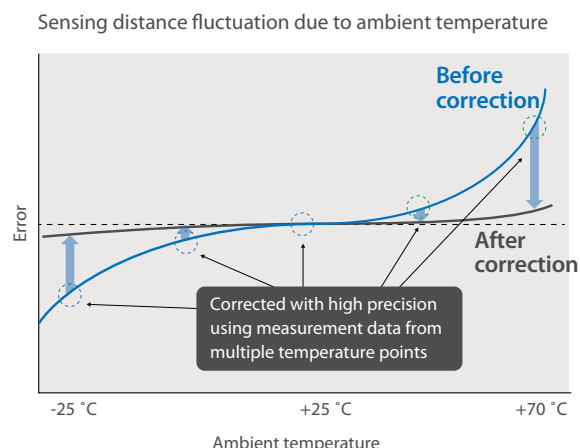

User friendly design reduces equipment downtime

Indicator can be seen regardless of orientation

Previous models

Detection validation during installation can be difficult based on the location of the detector on the equipment.

E2E NEXT

With high-brightness LED, the indicator is visible 360° around, making detection validation easy.

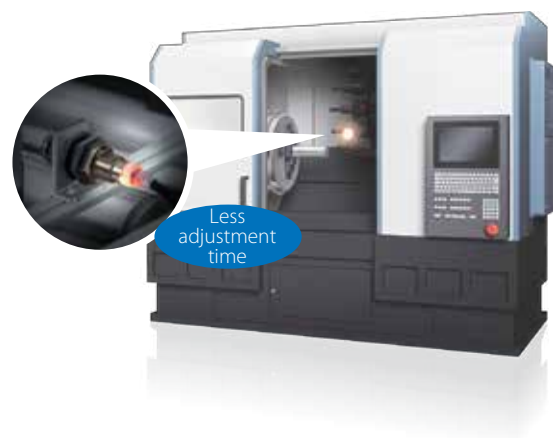

Easily upgrade existing equipment with 10-second proximity sensor replacements

The sensing distance of E2E-NEXT is approximately twice that of previous models. For example, the sensing distance of the M12 models is 9 mm, which is about the same as conventional M18 models. Using these sensors together with Quick fix allows easy upgrades to existing equipment in just 10 seconds.*

1. Dismount the M18 proximity sensor from the existing facility.
2. Mount an M18-sized Quick fix.
3. Insert an E2E NEXT Series M12 Proximity Sensor into the Quick fix.

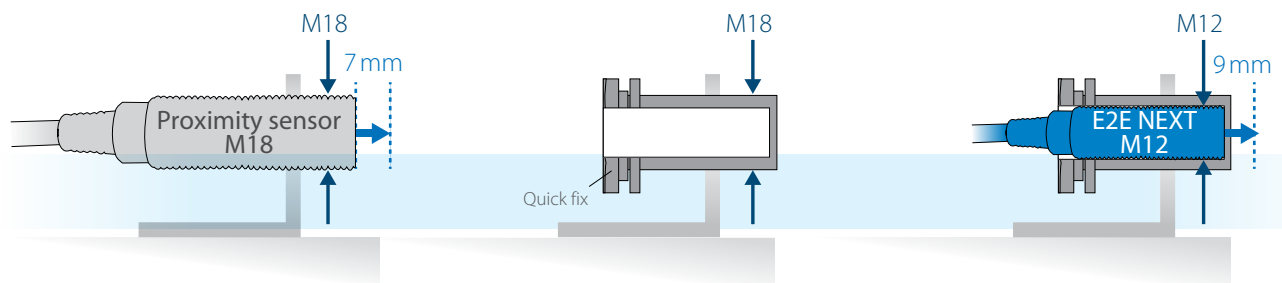

Note: All sensing distances are for 2-wire models.

* Time required to adjust the distance when installing a sensor. Based on OMRON investigation.

IO-Link 3-wire models

allow early identification of sensor failures

Using the IO-Link Master to connect IO-Link sensors to controllers enables replacement time reduction by detecting the location and cause of failures in real time.



Monitors real-time sensor failure from a single location.

By using the IO-Link Master to connect proximity sensors and controllers, HMI's can be used for early detection of location and nature of sensor failures.



* Screen is a conceptual illustration.

Predictive maintenance through condition monitoring.

- Send info from sensor to controller using IO-Link Master for stable connections with host equipment
- Facilitate real time condition monitoring and predictive maintenance with IO-Link
- Increase productivity through data collection and analysis



Ordering information

E2E (1) - X (2) (3) (4) (5) (6) (7) - (8) - (9) - (10) (11)

E2E/E2EQ NEXT Series model number legend DC 3-wire	No.	Type	Code	Meaning
	(1)	Case	Blank	Without splatter-resistant coating
			Q	With splatter resistant coating
	(2)	Sensing distance	Number	Sensing distance (Unit: mm) (R: Indication of decimal point)
	(3)	Shielding	Blank	Shielded
			M	Unshielded
	(4)	Output configuration	B	PNP open collector
			C	NPN open collector
	(5)	Operation mode	1	Normally open (NO)
			2	Normally closed (NC)
			3	Normally open, Normally closed (NO+NC)
(6)	IO-Link baud rate	Blank	IO-Link baud rate	
		D	COM2 (38.4 kbps)	
		T	COM3 (230.4 kbps)	
(7)	Body Size	Blank	Standard	
		L	Long Body	
(8)	Size	8	M8	
		12	M12	
		18	M18	
		30	M30	
(9)	Connection method	Blank	Pre-wired Models	
		M1	M12 Connector Models	
		M3	M8 (4-pin) Connector Models	
		M5	M8 (3-pin) Connector Models	
		M1TJ	M12 Pre-wired Smartclick Connector Models (pigtail)	
		M1TJR	M12 Pre-wired Smartclick Connector Models Robot (bending-resistant) cable (robot pigtail)	
(10)	Cable specifications *	Blank	Standard PVC cable	
		R	Robot (bending-resistant) cable	
(11)	Cable length	Number M	Cable length	

* (10) is only shown in the model number of Pre-wired Models.
 Note: The purpose of this model number legend is to provide understanding of the meaning of specifications from the model number. Models are not available for all combinations of code numbers.

E2E NEXT Series (Quadruple distance model part number example)

Size (Sensing Distance)	Connection Method	Body Size	Operation Mode	Model	
				PNP	NPN
M8 (4mm)	Pre-wired (2M)	38 mm ^{*2}	NO	E2E-X4B1D8 2M	E2E-X4C18 2M
			NC	E2E-X4B28 2M	E2E-X4C28 2M
		48 mm	NO	E2E-X4B1DL8 2M	E2E-X4C1L8 2M
			NC	E2E-X4B2L8 2M	E2E-X4C2L8 2M
	M12 Connector	43 mm ^{*3}	NO	E2E-X4B1D8-M1	E2E-X4C18-M1
			NC	E2E-X4B28-M1	E2E-X4C28-M1
		53 mm	NO	E2E-X4B1DL8-M1	E2E-X4C1L8-M1
			NC	E2E-X4B2L8-M1	E2E-X4C2L8-M1

*1. Models with 5-m cable length are also available with "5M" suffix. (Example: E2E-X9B1D12 5M)

*2. Models with 2-m and 5-m robot (bending-resistant) cables are also available with "R" in the model number. (Example: E2E-X9B1D12-R 2M/E2E-X9B1D12-R 5M)

*3. Models with M12 Smartclick connector model robot (bending-resistant) cables are also available with "R" in the model number. (Example: E2EX9B1D12-M1TJR 0.3M)

OMRON AUTOMATION AMERICAS HEADQUARTERS • Chicago, IL USA • 847.843.7900 • 800.556.6766 • automation.omron.com

OMRON CANADA, INC. • HEAD OFFICE

Toronto, ON, Canada • 416.286.6465 • 866.986.6766 • automation.omron.com

OMRON ELECTRONICS DE MEXICO • HEAD OFFICE

Ciudad de México • 52.55.5901.4300 • 01.800.386.6766 • mela@omron.com

OMRON ELECTRONICS DE MEXICO • SALES OFFICE

San Pedro Garza García, N.L. • 81.12.53.7392 • 01.800.386.6766 • mela@omron.com

OMRON ELECTRONICS DE MEXICO • SALES OFFICE

Eugenio Garza Sada, León, Gto • 01.800.386.6766 • mela@omron.com

OMRON ELETRÔNICA DO BRASIL LTDA • HEAD OFFICE

São Paulo, SP, Brasil • 55.11.2101.6300 • www.omron.com.br

OMRON ARGENTINA • SALES OFFICE

Buenos Aires, Argentina • +54.11.4521.8630 • +54.11.4523.8483
mela@omron.com

OTHER OMRON LATIN AMERICA SALES

+54.11.4521.8630 • +54.11.4523.8483 • mela@omron.com

Authorized Distributor:

Controllers & I/O

- Machine Automation Controllers (MAC) • Motion Controllers
- Programmable Logic Controllers (PLC) • Temperature Controllers • Remote I/O

Robotics

- Industrial Robots • Mobile Robots

Operator Interfaces

- Human Machine Interface (HMI)

Motion & Drives

- Machine Automation Controllers (MAC) • Motion Controllers • Servo Systems
- Frequency Inverters

Vision, Measurement & Identification

- Vision Sensors & Systems • Measurement Sensors • Auto Identification Systems

Sensing

- Photoelectric Sensors • Fiber-Optic Sensors • Proximity Sensors
- Rotary Encoders • Ultrasonic Sensors

Safety

- Safety Light Curtains • Safety Laser Scanners • Programmable Safety Systems
- Safety Mats and Edges • Safety Door Switches • Emergency Stop Devices
- Safety Switches & Operator Controls • Safety Monitoring/Force-guided Relays

Control Components

- Power Supplies • Timers • Counters • Programmable Relays
- Digital Panel Meters • Monitoring Products

Switches & Relays

- Limit Switches • Pushbutton Switches • Electromechanical Relays
- Solid State Relays

Software

- Programming & Configuration • Runtime

Компания «Океан Электроники» предлагает заключение долгосрочных отношений при поставках импортных электронных компонентов на взаимовыгодных условиях!

Наши преимущества:

- Поставка оригинальных импортных электронных компонентов напрямую с производств Америки, Европы и Азии, а так же с крупнейших складов мира;
- Широкая линейка поставок активных и пассивных импортных электронных компонентов (более 30 млн. наименований);
- Поставка сложных, дефицитных, либо снятых с производства позиций;
- Оперативные сроки поставки под заказ (от 5 рабочих дней);
- Экспресс доставка в любую точку России;
- Помощь Конструкторского Отдела и консультации квалифицированных инженеров;
- Техническая поддержка проекта, помощь в подборе аналогов, поставка прототипов;
- Поставка электронных компонентов под контролем ВП;
- Система менеджмента качества сертифицирована по Международному стандарту ISO 9001;
- При необходимости вся продукция военного и аэрокосмического назначения проходит испытания и сертификацию в лаборатории (по согласованию с заказчиком);
- Поставка специализированных компонентов военного и аэрокосмического уровня качества (Xilinx, Altera, Analog Devices, Intersil, Interpoint, Microsemi, Actel, Aeroflex, Peregrine, VPT, Syfer, Eurofarad, Texas Instruments, MS Kennedy, Miteq, Cobham, E2V, MA-COM, Hittite, Mini-Circuits, General Dynamics и др.);

Компания «Океан Электроники» является официальным дистрибьютором и эксклюзивным представителем в России одного из крупнейших производителей разъемов военного и аэрокосмического назначения «JONHON», а так же официальным дистрибьютором и эксклюзивным представителем в России производителя высокотехнологичных и надежных решений для передачи СВЧ сигналов «FORSTAR».



JONHON

«JONHON» (основан в 1970 г.)

Разъемы специального, военного и аэрокосмического назначения:

(Применяются в военной, авиационной, аэрокосмической, морской, железнодорожной, горно- и нефтедобывающей отраслях промышленности)

«FORSTAR» (основан в 1998 г.)

ВЧ соединители, коаксиальные кабели,
кабельные сборки и микроволновые компоненты:

(Применяются в телекоммуникациях гражданского и специального назначения, в средствах связи, РЛС, а так же военной, авиационной и аэрокосмической отраслях промышленности).



Телефон: 8 (812) 309-75-97 (многоканальный)

Факс: 8 (812) 320-03-32

Электронная почта: ocean@oceanchips.ru

Web: <http://oceanchips.ru/>

Адрес: 198099, г. Санкт-Петербург, ул. Калинина, д. 2, корп. 4, лит. А