

CBT-90-UV LEDs

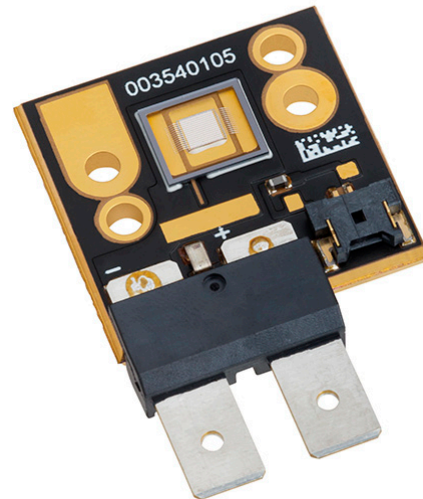

Table of Contents

Technology Overview	2
CBT-90 Bin Structure	3
Electrical & Optical Characteristics	4
Lifetime, Reliability and Typical Spectrum	5
Radiation Patterns	6
Thermal Resistance	7
Mechanical Dimensions	8
Ordering Information	9

Features:

- Greater than 12 W of optical power from 400 nm to 410 nm.
- High thermal conductivity package .
 - › Junction to heat sink thermal resistance of 0.9 °C/W
- Luminus technology for very high power density and uniform surface emission
- Large, monolithic chip with surface emitting area of 9 mm²
- Low-profile window for efficient coupling into small-étendue systems
- High radiometric efficiency
- Environmentally friendly: RoHS compliant, mercury-free
- Variable drive currents: less than 1 A through 22.5 A

Applications

- Spot-curing
- Inspection
- Machine Vision
- Fiber-coupled illumination
- Rapid Prototyping and 3D printing
- Medical and Scientific Instrumentation

Technology Overview

Luminus Big Chip LEDs™ benefit from innovations in device technology, chip packaging and thermal management. This suite of technologies give engineers and system designers the freedom to develop solutions both high in power and efficiency.

Luminus Technology

Luminus' technology enables large area LED chips to emit photons uniformly over the entire LED chip surface. The intense optical power density produced by these UV LEDs™ facilitate designs which replace arc and halogen lamps where arrays of traditional high power LEDs cannot.

For UV devices, Luminus engineers the LEDs™ to maximize light extraction and to emit with a Lambertian far-field distribution pattern. The design maximizes efficiency and allows for flexible optical designs.

Packaging Technology

Thermal management is critical in high power LED applications. With a thermal resistance from junction to heat sink of 0.9°C/W, Luminus CBT-90-UV LEDs have the lowest thermal resistance of any LED on the market. This allows the LED to be driven at higher current densities while maintaining a low junction temperature, thereby resulting in brighter solutions and longer lifetimes.

Reliability

Designed from the ground up, Luminus LEDs are one of the most reliable light sources in the world today. Big Chip LEDs have passed a rigorous suite of environmental and mechanical stress tests, including mechanical shock, vibration, temperature cycling and humidity, and have been fully qualified for use in extreme high power and high current applications. With very low failure rates and median lifetimes that typically exceed 10,000 hours, Luminus Big Chip LEDs are ready for even the most demanding applications.

Environmental Benefits

Luminus LEDs help reduce power consumption and the amount of hazardous waste entering the environment. All LED products manufactured by Luminus are RoHS compliant and free of hazardous materials, including lead and mercury.

Understanding Big Chip LED Test Specifications

Every Luminus LED is fully tested to ensure that it meets the high quality standards expected from Luminus' products.

Testing Temperature

Luminus core board products are typically measured in such a way that the characteristics reported agree with how the devices will actually perform when incorporated into a system. This measurement is accomplished by mounting the devices on a 40°C heat sink and measuring the device while fully powered.

This method of measurement ensures that Luminus Big Chip LEDs perform in the field just as they are specified.

Multiple Operating Points

The tables on the following pages provide typical optical and electrical characteristics. Since the LEDs can be operated over a wide range of drive conditions (currents from <1A to 22.5 A, and duty cycle from <1% to 100%), multiple drive conditions maybe listed.

CBT-90-UV devices are production specified at 13.5 A. Driving devices beyond recommended driving conditions shortens lifetime (see derating curves on page 6).

CBT-90-UV Bin Structure

CBT-90 LEDs are specified for Radiant Flux (power) and wavelength at a drive current of 13.5 A (1.5 A/mm²) and placed into one of the following luminous flux (F) and wavelength (123) bins:

Power Bins

Color	Power Flux Bin (F)	Minimum Flux (W)	Maximum Flux (W)
UV	L	12.1	13.3
	M	13.3	14.6

*Note: Luminus maintains a +/- 6% tolerance on power measurements.

Wavelength Bins

Color	Wavelength Bin (123)	Minimum Wavelength (nm)	Maximum Wavelength (nm)
UV	400	400	405
	405	405	410

For ordering information, please refer to page 5 of CBT-90-UV Binning & Labeling Document PDS-002172.

Reference Optical & Electrical Characteristics ($T_{hs} = 40^{\circ}\text{C}$)^{1,2}

UV				
Drive Condition		9A	13.5 A	
Parameter	Symbol	Values ³		Unit
Current Density	J	1.0	1.5	A/mm ²
Forward Voltage	V_{Fmin}	-	3.2	V
	V_F	3.3	3.4	V
	V_{Fmax}	-	4.0	V
Radiometric Flux ⁴	Φ_{typ}	8.9	13.4	W
Radiometric Flux Density	Φ_R	0.55	0.83	W/mm ²
Wavelength Range	λ	400 - 410	400 - 410	nm
Peak Wavelength	λ_p	405	405	nm
FWHM	$\Delta\lambda_{1/2}$	14	14	nm

	Symbol	UV	Unit
Emitting Area		9	mm ²
Emitting Area Dimensions		3 × 3	mm × mm
Dynamic Resistance	Ω_{dyn}	0.02	Ω

Absolute Maximum Ratings

	Symbol	UV	Unit
Maximum Current ⁵		22.5	A
Maximum Junction Temperature ⁶	T_{jmax}	150	°C
Storage Temperature Range		-40 to +100	°C

Note 1: Data verified with NIST calibration standard.

Note 2: All data are based on test conditions with a constant heat sink temperature $T_{hs} = 40^{\circ}\text{C}$ under pulse testing conditions. Listed drive conditions are typical for common applications. CBT-90-UV devices can be driven at currents ranging from <1 A to 22.5 A and at duty cycles ranging from 1% to 100%. Drive current and duty cycle should be adjusted as necessary to maintain the junction temperature desired to meet application lifetime requirements. See Thermal Resistance section for T_j and T_{hs} definition.

Note 3: Unless otherwise noted, values listed are typical. Devices are production tested and specified at 13.5 A.

Note 4: Total flux from emitting area at listed peak wavelength. Reported performance is included to show trends for a selected power level. For product roadmap and future performance of devices, contact Luminus.

Note 5: CBT-90-UV LEDs are designed for operation to an absolute maximum current as specified above. Product lifetime data is specified at recommended forward drive currents. Sustained operation at or beyond absolute maximum currents will result in a reduction of device life time compared to recommended forward drive currents. Actual device lifetimes will also depend on junction temperature. Refer to the lifetime derating curves for further information. In pulsed operation, rise time from 10-90% of forward current should be longer than 0.5 $\mu\text{seconds}$.

Note 6: Lifetime dependent on LED junction temperature. Input power and thermal system must be properly managed to ensure lifetime. See charts on page 6 for further information.

Note 7: Special design considerations must be observed for operation under 1 A. Please contact Luminus for further information.

Optical Power Characteristics

Relative Power vs Forward Current (I_f)
Normalized to 13.5 A

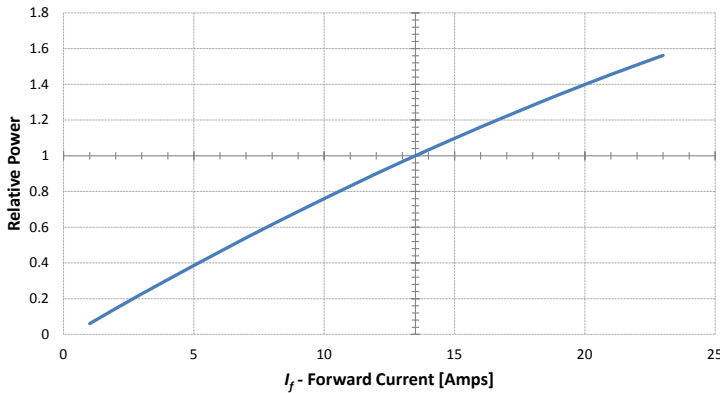

Relative Power vs Junction Temperature (T_j)
Normalized to 80°C

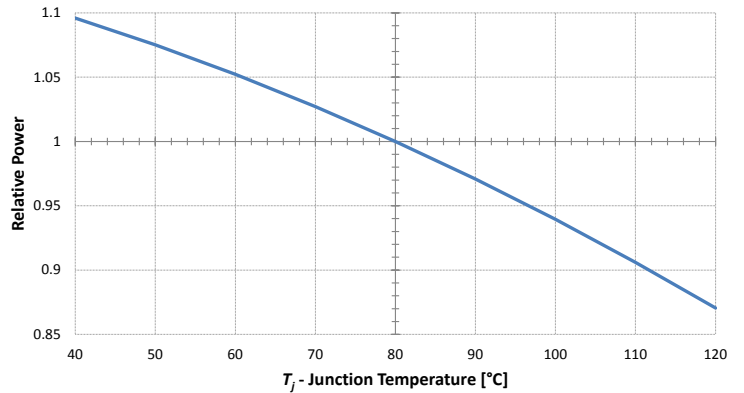

Forward Voltage Characteristics

Change in Forward Voltage (V_f) vs Forward Current (I_f)
Referenced to 13.5 A

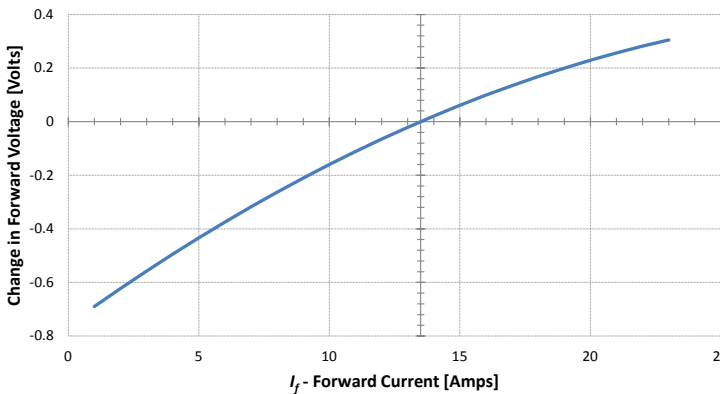

Change in Forward Voltage (V_f) vs Junction Temperature (T_j)
Referenced to 80°C

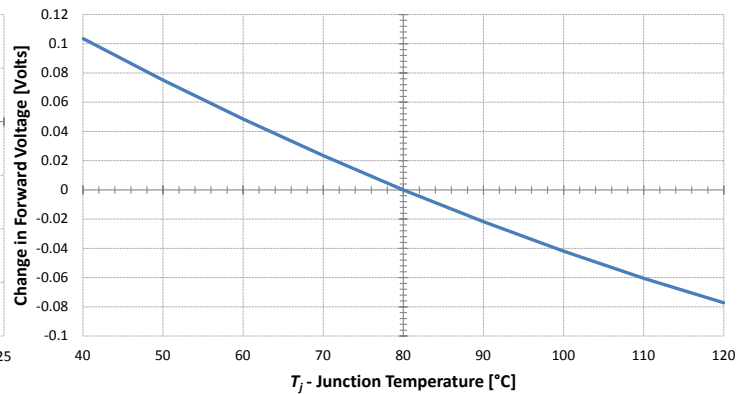

Peak Wavelength Characteristics

Change in Peak Wavelength (λ_p) vs Forward Current (I_f)
Referenced to 13.5 A

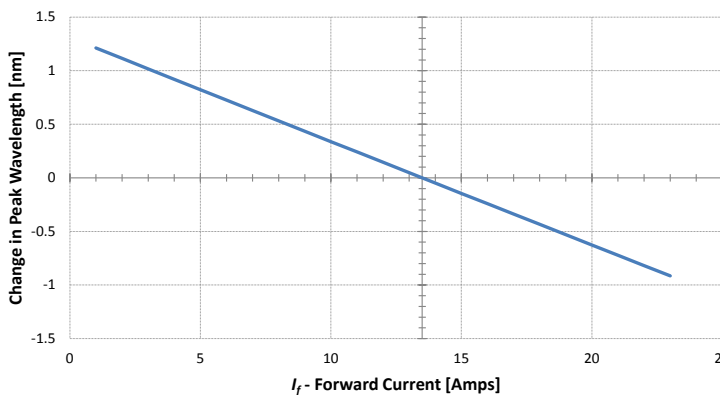

Change in Peak Wavelength (λ_p) vs Temperature (T_j)
Referenced to 80°C

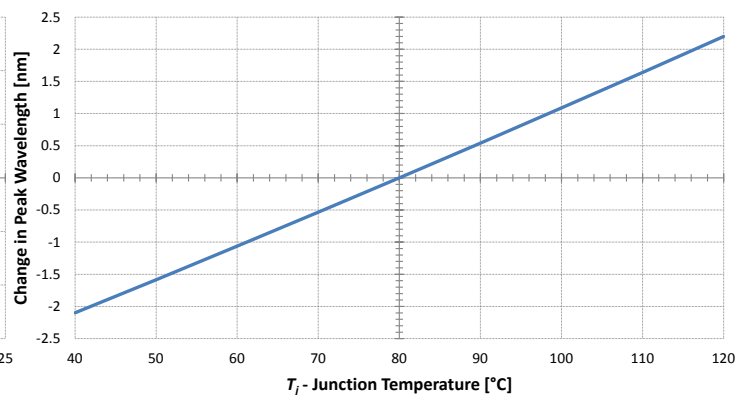

CBT-90-UV B50 Reliability⁸

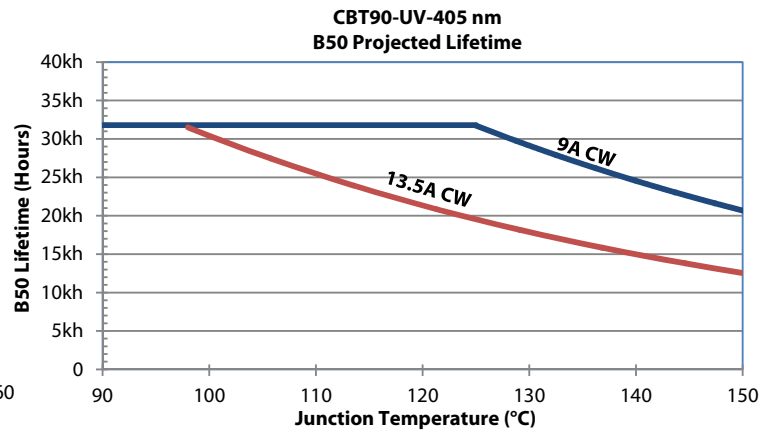
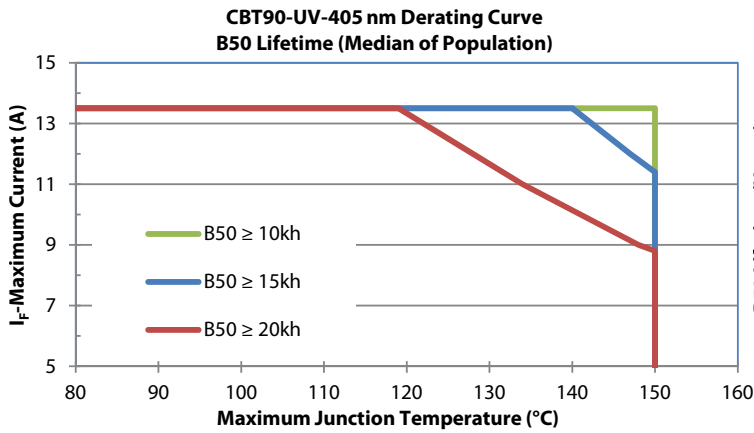

CBT-90-UV B10 Reliability⁸

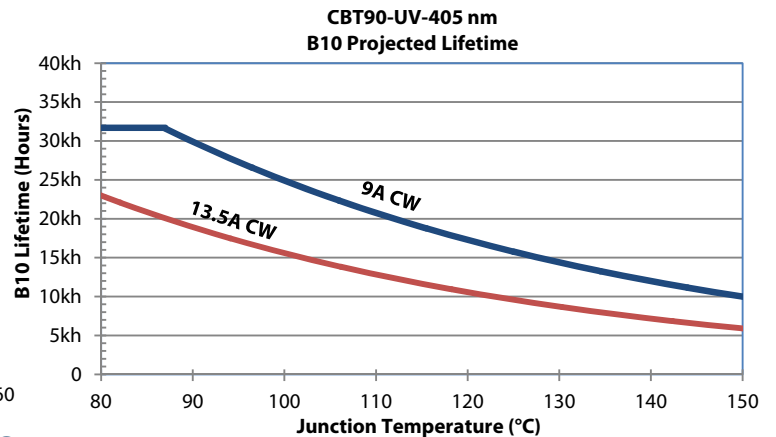
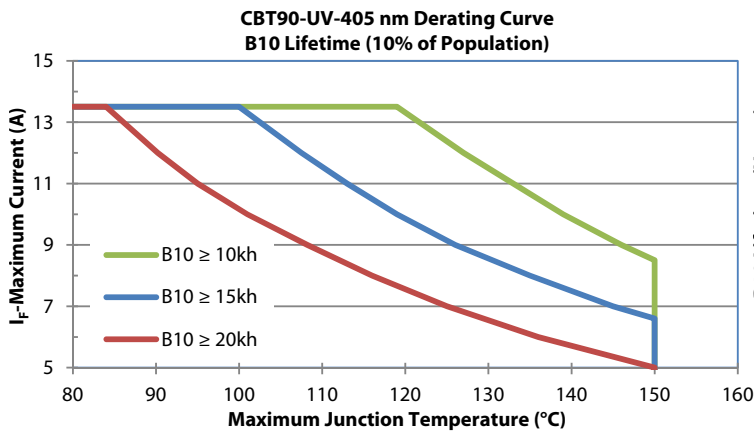

Typical Spectrum

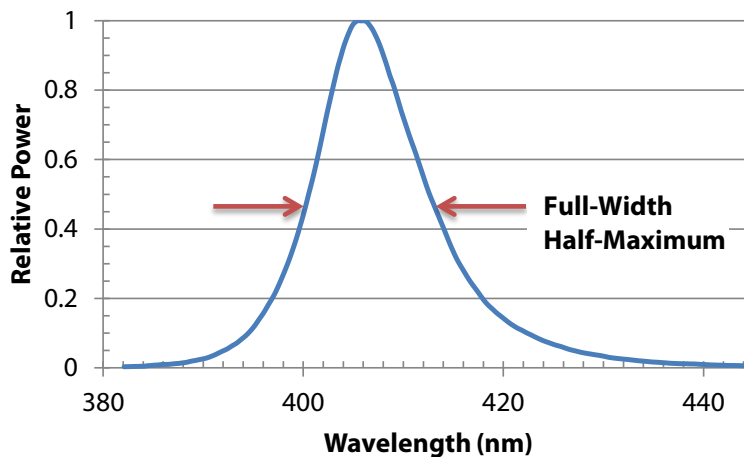

Note 8 Lifetime defined as time to 70% of initial intensity. Based on preliminary lifetime test data. Data can be used to model failure rate over typical product lifetime.

Typical Radiation Pattern

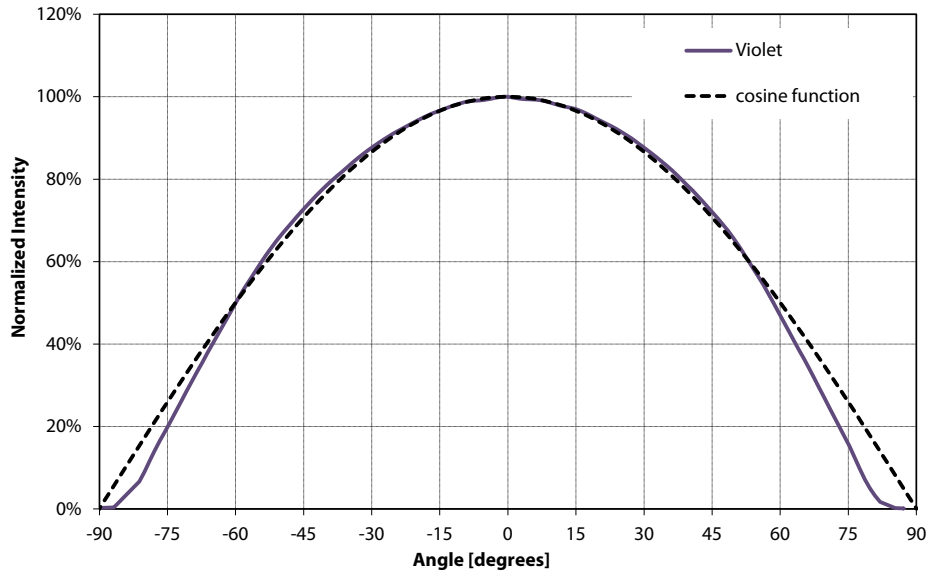

Thermal Resistance

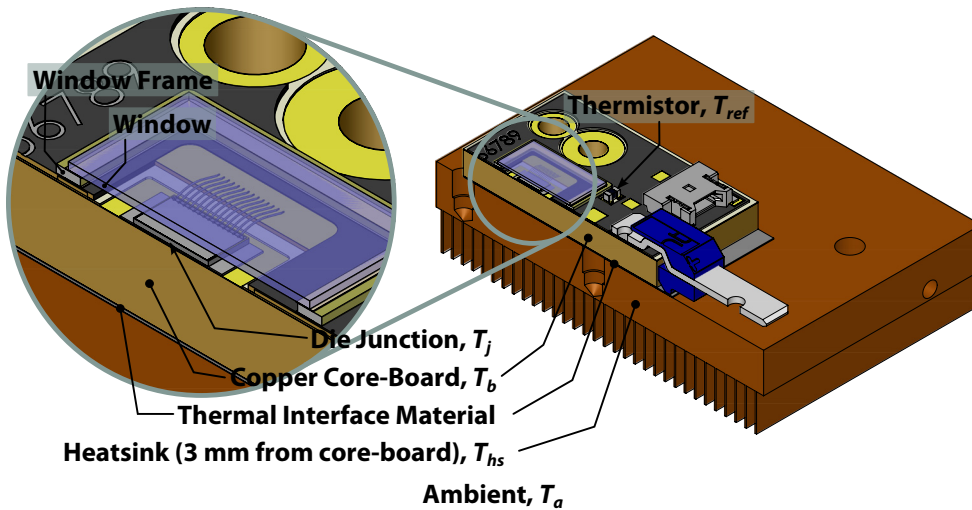

Typical Thermal Resistance

$R_{\theta j-b}^1$	0.80 °C/W
$R_{\theta b-hs}^1$	0.12 °C/W
$R_{\theta j-hs}^2$	0.92 °C/W
$R_{\theta j-ref}^1$	0.83 °C/W

Note 1: Thermal resistance values are based on FEA model results correlated to measured $R_{\theta j-hs}$ data.

Note 2: Thermal Resistance is based on eGraf 1205 Thermal interface.

Thermistor Information

The thermistor used in CBT-90 devices mounted on coreboards is from Murata Manufacturing Co. The global part number is NCP18XH103J03RB. Please see <http://www.murata.com/> for details on calculating thermistor temperature.

For more information on use of the thermistor, please contact Luminus directly.

Electrical Pinout

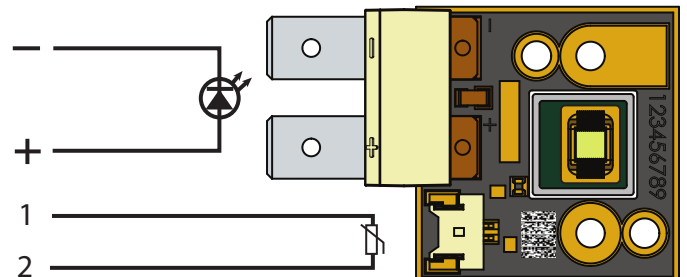

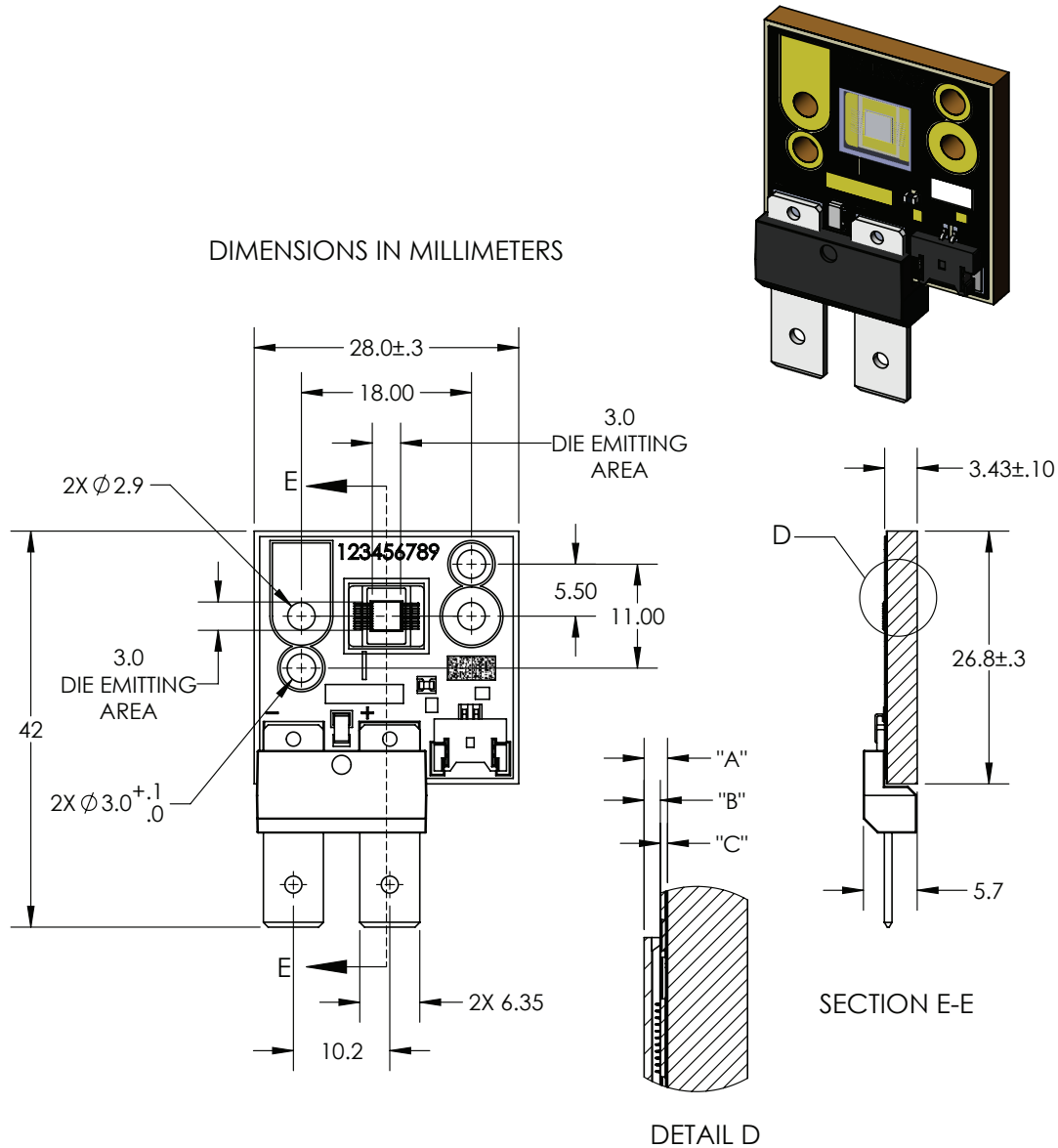
Mechanical Dimensions – CBT-90-UV Emitter

DIMENSION NAME	DESCRIPTION	NOMINAL DIMENSION	TOLERANCE
"A"	TOP OF METAL SUBSTRATE TO TOP OF WINDOW	.91	±.13
"B"	TOP OF DIE EMITTING AREA TO TOP OF WINDOW	.64	±.11
"C"	TOP OF METAL SUBSTRATE TO TOP OF DIE EMITTING AREA	.27	±.02

DWG-002183

Recommended connector for Anode and Cathode: Panduit Disco Lok™ Series P/N: DNG14-250FL-C.

Thermistor Connector: MOLEX P/N 53780-0270. Recommended Female: MOLEX P/N 51146-0200 or equivalent.

Ordering Information

Products	Ordering Part Number	Description
CBT-90-UV-C31	CBT-90-UV-C31-x123-22	CBT-90 -UV consisting of a 9 mm ² LED, a thermistor, connectors, and a copper-core PCB.

Note: For information on ordering specific bins or bin ranges please refer to the CBT-90-UV Binning and Labeling document PDS-002172.



The products, their specifications and other information appearing in this document are subject to change by Luminus Devices without notice. Luminus Devices assumes no liability for errors that may appear in this document, and no liability otherwise arising from the application or use of the product or information contained herein. None of the information provided herein should be considered to be a representation of the fitness or suitability of the product for any particular application or as any other form of warranty. Luminus Devices' product warranties are limited to only such warranties as accompany a purchase contract or purchase order for such products. Nothing herein is to be construed as constituting an additional warranty. No information contained in this publication may be considered as a waiver by Luminus Devices of any intellectual property rights that Luminus Devices may have in such information. Big Chip LEDs™ is a registered trademark of Luminus Devices, Inc., all rights reserved.

This product is protected by U.S. Patents 6,831,302; 7,074,631; 7,083,993; 7,084,434; 7,098,589; 7,105,861; 7,138,666; 7,166,870; 7,166,871; 7,170,100; 7,196,354; 7,211,831; 7,262,550; 7,274,043; 7,301,271; 7,341,880; 7,344,903; 7,345,416; 7,348,603; 7,388,233; 7,391,059 Patents Pending in the U.S. and other countries.

Компания «Океан Электроники» предлагает заключение долгосрочных отношений при поставках импортных электронных компонентов на взаимовыгодных условиях!

Наши преимущества:

- Поставка оригинальных импортных электронных компонентов напрямую с производств Америки, Европы и Азии, а так же с крупнейших складов мира;
- Широкая линейка поставок активных и пассивных импортных электронных компонентов (более 30 млн. наименований);
- Поставка сложных, дефицитных, либо снятых с производства позиций;
- Оперативные сроки поставки под заказ (от 5 рабочих дней);
- Экспресс доставка в любую точку России;
- Помощь Конструкторского Отдела и консультации квалифицированных инженеров;
- Техническая поддержка проекта, помощь в подборе аналогов, поставка прототипов;
- Поставка электронных компонентов под контролем ВП;
- Система менеджмента качества сертифицирована по Международному стандарту ISO 9001;
- При необходимости вся продукция военного и аэрокосмического назначения проходит испытания и сертификацию в лаборатории (по согласованию с заказчиком);
- Поставка специализированных компонентов военного и аэрокосмического уровня качества (Xilinx, Altera, Analog Devices, Intersil, Interpoint, Microsemi, Actel, Aeroflex, Peregrine, VPT, Syfer, Eurofarad, Texas Instruments, MS Kennedy, Miteq, Cobham, E2V, MA-COM, Hittite, Mini-Circuits, General Dynamics и др.);

Компания «Океан Электроники» является официальным дистрибьютором и эксклюзивным представителем в России одного из крупнейших производителей разъемов военного и аэрокосмического назначения «**JONHON**», а так же официальным дистрибьютором и эксклюзивным представителем в России производителя высокотехнологичных и надежных решений для передачи СВЧ сигналов «**FORSTAR**».



JONHON

«**JONHON**» (основан в 1970 г.)

Разъемы специального, военного и аэрокосмического назначения:

(Применяются в военной, авиационной, аэрокосмической, морской, железнодорожной, горно- и нефтедобывающей отраслях промышленности)

«**FORSTAR**» (основан в 1998 г.)

ВЧ соединители, коаксиальные кабели,
кабельные сборки и микроволновые компоненты:

(Применяются в телекоммуникациях гражданского и специального назначения, в средствах связи, РЛС, а так же военной, авиационной и аэрокосмической отраслях промышленности).



Телефон: 8 (812) 309-75-97 (многоканальный)

Факс: 8 (812) 320-03-32

Электронная почта: ocean@oceanchips.ru

Web: <http://oceanchips.ru/>

Адрес: 198099, г. Санкт-Петербург, ул. Калинина, д. 2, корп. 4, лит. А