

### 1A Step-down DC/DC Converters with Synchronous Rectifier

NO.EA-273-150317

#### OUTLINE

The RP505K Series are low supply current CMOS-based 1A\*1 step-down DC/DC Converters with synchronous rectifier. Each of these ICs consists of an oscillator, a reference voltage unit, an error amplifier, a switching control circuit, a mode control circuit, a soft-start circuit, a latch type protection circuit, an under voltage lock out (UVLO) circuit, a thermal shutdown circuit, and a switching transistors. A low ripple, high efficiency synchronous rectifier step-down DC/DC converter can be easily composed of this IC with only an inductor and capacitors. Since the package is DFN(PLP)2020-8, high density mounting on boards is possible.

In the RP505K series, as for the A version and B version, since feedback resistors are built-in, the voltage is fixed internally. 0.1V step output can be set by laser-trim and  $\pm 1.5\%$  ( $V_{OUT} \geq 1.2V$ ) or 18mV ( $V_{OUT} < 1.2V$ ) tolerance is guaranteed. As for the C version, output voltage is adjustable with external divider resistors.

By inputting a signal to MODE pin, the RP505K Series can choose PWM/VFM alternative mode or forced PWM mode. In low output current, PWM/VFM alternative mode automatically switches from PWM to VFM in order to achieve high efficiency. Likewise, in low output current, Forced PWM mode switches at fixed frequency in order to reduce noise.

As protection circuits, the RP505K Series contain a current limit circuit which limits the Lx peak current in each clock cycle, and a latch type protection circuit which latches the built-in driver to the OFF state if the load current exceeds the limit value or the output short continues for a specified time (the protection delay time). The latch protective circuit can be released by once putting the IC into the standby mode with the CE pin and then into the active mode, or, by turning the power off and back on. Setting the supply voltage lower than the UVLO detector threshold can also release the latch protective circuit. The RP505K Series also contain a thermal shutdown circuit which detects the overheating and resets the IC when the junction temperature of the RP505K Series exceeds the specified temperature.

\*1 This is an approximate value, because output current depends on conditions and external parts.

#### FEATURES

- Supply Current ..... Typ. 40 $\mu$ A (VFM mode with no-load)
- Standby Current ..... Max. 5 $\mu$ A
- Input Voltage Range ..... 2.3V to 5.5V (Absolute maximum rating: 6.5V)
- Output Voltage Range (Ver.A,B) ..... 0.6V to 3.3V (Adjustable in 0.1V steps.  
Note: As for 0.8V or less, input voltage range is limited.)  
(Ver.C) ..... 0.8V to 3.3V
- Output Voltage Accuracy (Ver.A,B) .....  $\pm 1.5\%$  ( $V_{OUT} \geq 1.2V$ ),  $\pm 18mV$  ( $V_{OUT} < 1.2V$ )
- Feedback Voltage Accuracy (Ver.C) .....  $\pm 9mV$  ( $V_{FB} = 0.6V$ )
- Temperature-Drift Coefficient of Output Voltage/ Feedback  
..... Typ.  $\pm 100ppm/^{\circ}C$
- Oscillator Frequency ..... Typ. 2.25MHz
- Oscillator Maximum Duty Cycle ..... Min. 100%
- Built-in Driver ON Resistance ..... Typ. Pch. 0.23 $\Omega$ , Nch. 0.20 $\Omega$  ( $V_{IN} = 3.6V$ )
- UVLO Detector Threshold ..... Typ. 2.0V
- Soft-start Time ..... Typ. 0.15ms
- Lx Current Limit Circuit ..... Typ. 1.7A
- Latch Type Protection Circuit ..... Typ. 1.5ms
- Package ..... DFN(PLP)2020-8

## APPLICATIONS

- Power source for portable equipment such as cellular, PDA, DSC, Notebook PC
- Power source for HDD, WLAN.
- Power source for Li-ion battery-used equipment

## BLOCK DIAGRAMS

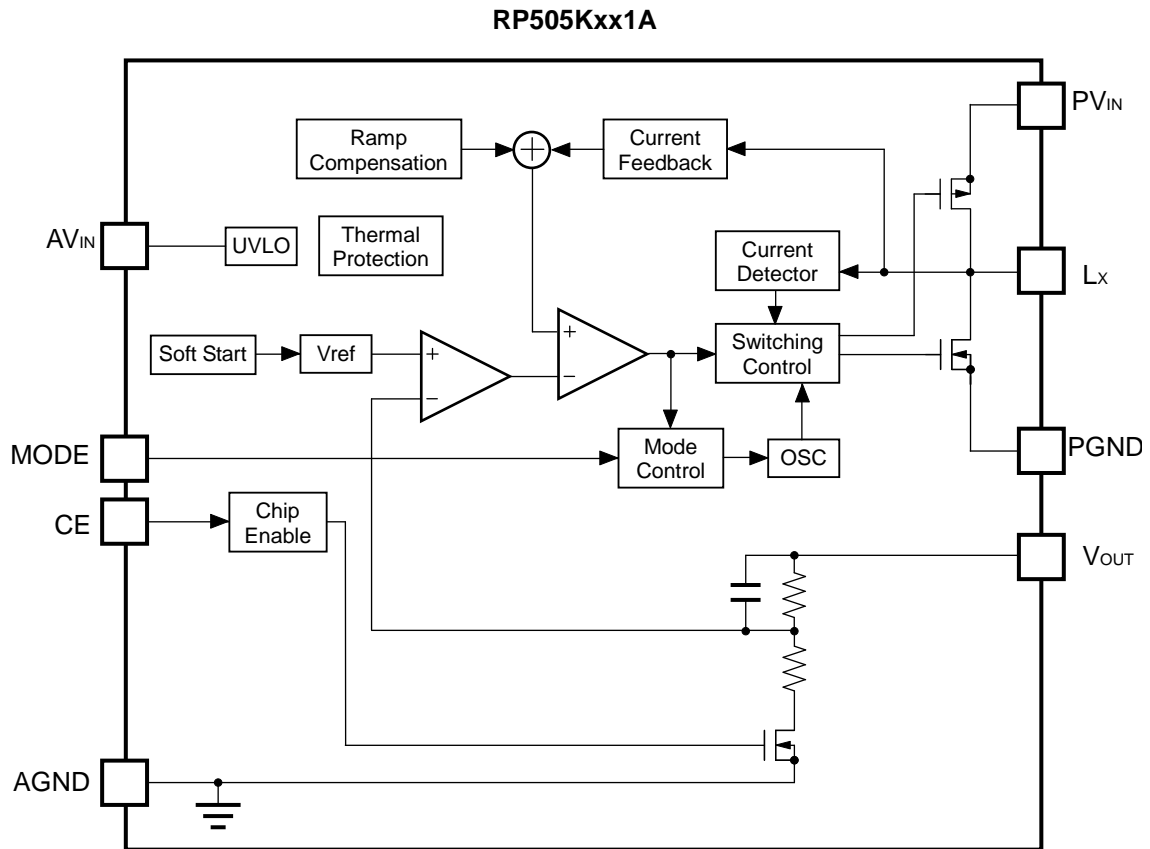

RP505Kxx1B

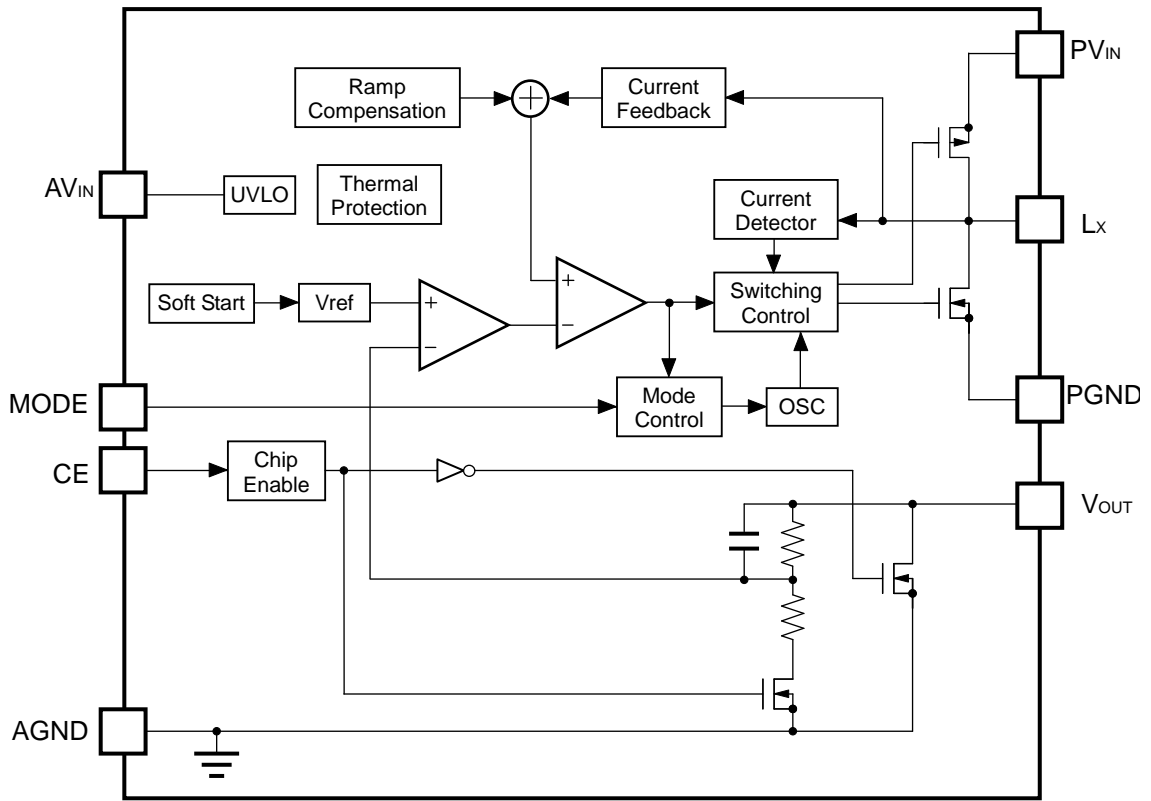

RP505K001C

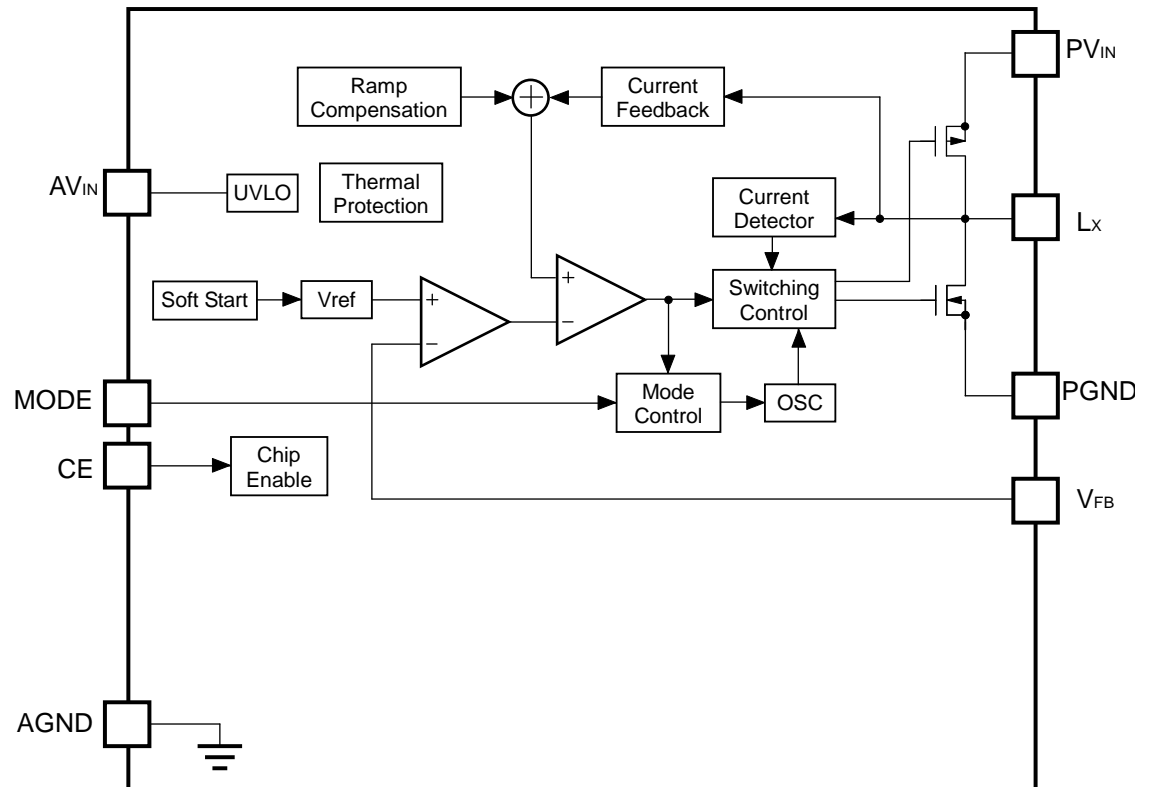

## SELECTION GUIDE

In the RP505K Series, output voltage, and auto discharge function for the IC are selectable at the user's request.

Product Name	Package	Quantity per Reel	Pb Free	Halogen Free
RP505Kxx1\$-TR	DFN(PLP)2020-8	5,000pcs	Yes	Yes

xx : The output voltage can be designated in the range from 0.6V(06) to 3.3V(33) in 0.1V<sup>\*1</sup> steps.

The output voltage adjustable type: xx=00

(For other voltages, please refer to MARK INFORMATION.)

\$ : Designation of Mask Option

A) Fixed output voltage type, without auto-discharge function at off state

B) Fixed output voltage type, with auto-discharge function at off state

C) Adjustable output voltage type, without auto-discharge function at off state

Auto-discharge function quickly lowers the output voltage to 0V, when the chip enable signal is switched from the active mode to the standby mode, by releasing the electrical charge accumulated in the external capacitor.

\*1 0.05V step is also available as a custom code.

## PIN CONFIGURATIONS

### • DFN(PLP)2020-8

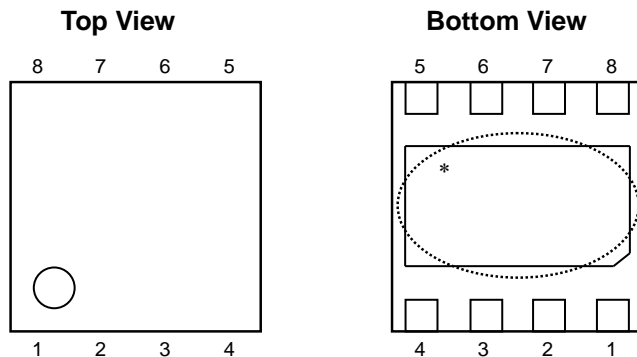

## PIN DESCRIPTIONS

### • RP505K: DFN(PLP)2020-8

Pin No.	Symbol	Description
1	MODE	Mode Control Pin ("H" Forced PWM Mode, "L" PWM/VFM Alternative Mode)
2	CE	Chip Enable Pin ("H" Active)
3	AV <sub>IN</sub>	Input Pin* <sup>1</sup>
4	PV <sub>IN</sub>	Input Pin* <sup>1</sup>
5	L <sub>X</sub>	L <sub>X</sub> Switching Pin
6	PGND	Ground Pin* <sup>1</sup>
7	AGND	Ground Pin* <sup>1</sup>
8	V <sub>OUT</sub> /V <sub>FB</sub>	Output Pin / Feedback Pin

Tab is GND level. (They are connected to the reverse side of this IC.) The tab is better to be connected to the GND, but leaving it open is also acceptable.

\*<sup>1</sup> No.3 pin and No.4 pin, and also No.6 pin and No.7 pin must be wired each other when mounted on boards.

## ABSOLUTE MAXIMUM RATINGS

(AGND=PGND=0V)

Symbol	Item	Rating	Unit
A/PV <sub>IN</sub>	AV <sub>IN</sub> /PV <sub>IN</sub> Input Voltage	-0.3 to 6.5	V
V <sub>LX</sub>	L <sub>X</sub> Pin Voltage	-0.3 to A/PV <sub>IN</sub> + 0.3	V
V <sub>CE</sub>	CE Pin Input Voltage	-0.3 to 6.5	V
V <sub>OUT</sub> /V <sub>FB</sub>	V <sub>OUT</sub> /V <sub>FB</sub> Pin Voltage	-0.3 to 6.5	V
V <sub>MODE</sub>	MODE Pin Voltage	-0.3 to 6.5	V
I <sub>LX</sub>	L <sub>X</sub> Pin Output Current	1.7	A
P <sub>D</sub>	Power Dissipation (Standard Test Land Pattern)* <sup>1</sup>	880	mW
T <sub>a</sub>	Operating Temperature Range	-40 to 85	°C
T <sub>stg</sub>	Storage Temperature Range	-55 to 125	°C

\*<sup>1</sup> For Power Dissipation and Standard Test Land Pattern, please refer to PACKAGE INFORMATION.

### ABSOLUTE MAXIMUM RATINGS

Electronic and mechanical stress momentarily exceeded absolute maximum ratings may cause the permanent damages and may degrade the life time and safety for both device and system using the device in the field. The functional operation at or over these absolute maximum ratings is not assured.

### RECOMMENDED OPERATING CONDITIONS (ELECTRICAL CHARACTERISTICS)

All of electronic equipment should be designed that the mounted semiconductor devices operate within the recommended operating conditions. The semiconductor devices cannot operate normally over the recommended operating conditions, even if when they are used over such conditions by momentary electronic noise or surge. And the semiconductor devices may receive serious damage when they continue to operate over the recommended operating conditions.

## ELECTRICAL CHARACTERISTICS

● RP505Kxx1A/B

(Ta=25°C)

Symbol	Item	Conditions	Min.	Typ.	Max.	Unit
A/PVIN	Operating Input Voltage	$0.8V \leq V_{OUT} \leq 3.3V$	2.3		5.5	V
		$0.7V \leq V_{OUT} < 0.8V$	2.3		4.4	
		$0.6V \leq V_{OUT} < 0.7V, \text{MODE} = "L"$ <sup>*1</sup>	2.3		4.2	
VOUT	Output Voltage	Refer to the conditions below. <sup>*2</sup>	$V_{OUT} \geq 1.2V$	-1.5%	+1.5%	V
			$V_{OUT} < 1.2V$	-0.018	+0.018	
$\Delta V_{OUT}/\Delta T$	Output Voltage Temperature Coefficient	$-40^\circ\text{C} \leq T_a \leq 85^\circ\text{C}$		±100		ppm/°C
fosc	Oscillator Frequency	Refer to the conditions below. <sup>*2</sup>	2.00	2.25	2.50	MHz
I <sub>DD1</sub>	Supply Current 1	$A/PV_{IN} = V_{CE} = 5.5V, V_{OUT} = V_{SET} \times 0.8$		500	840	μA
I <sub>DD2</sub>	Supply Current 2	$A/PV_{IN} = V_{CE} = V_{OUT} = 5.5V$	$V_{MODE} = 0V$	40	60	μA
			$V_{MODE} = 5.5V$	500	840	
I <sub>standby</sub>	Standby Current	$A/PV_{IN} = 5.5V, V_{CE} = 0V$		0	5	μA
I <sub>CEH</sub>	CE "H" Input Voltage	$A/PV_{IN} = V_{CE} = 5.5V$	-1	0	1	μA
I <sub>CEL</sub>	CE "L" Input Voltage	$A/PV_{IN} = 5.5V, V_{CE} = 0V$	-1	0	1	μA
I <sub>MODEH</sub>	Mode "H" Input Current	$A/PV_{IN} = V_{MODE} = 5.5V, V_{CE} = 0V$	-1	0	1	μA
I <sub>MODEL</sub>	Mode "L" Input Current	$A/PV_{IN} = 5.5V, V_{CE} = V_{MODE} = 0V$	-1	0	1	μA
I <sub>VOUTH</sub>	VOUT "H" Input Current <sup>*3</sup>	$A/PV_{IN} = V_{OUT} = 5.5V, V_{CE} = 0V$	-1	0	1	μA
I <sub>VOUTL</sub>	VOUT "L" Input Current	$A/PV_{IN} = 5.5V, V_{CE} = V_{OUT} = 0V$	-1	0	1	μA
R <sub>LOW</sub>	Nch On Resistance for Auto Discharge <sup>*4</sup>	$A/PV_{IN} = 3.6V, V_{CE} = 0V$		30		Ω
I <sub>LXLEAKH</sub>	LX Leakage Current "H"	$A/PV_{IN} = V_{LX} = 5.5V, V_{CE} = 0V$	-1	0	5	μA
I <sub>LXLEAKL</sub>	LX Leakage Current "L"	$A/PV_{IN} = 5.5V, V_{CE} = V_{LX} = 0V$	-5	0	1	μA
V <sub>CEH</sub>	CE "H" Input Voltage	$A/PV_{IN} = 5.5V$	1.0			V
V <sub>CEL</sub>	CE "L" Input Voltage	$A/PV_{IN} = 2.3V$			0.4	V
V <sub>MODEH</sub>	Mode "H" Input Voltage	$A/PV_{IN} = V_{CE} = 5.5V$	1.0			V
V <sub>MODEL</sub>	Mode "L" Input Voltage	$A/PV_{IN} = V_{CE} = 2.3V$			0.4	V
R <sub>ONP</sub>	On Resistance of Pch Tr.	$A/PV_{IN} = 3.6V, I_{LX} = -100\text{mA}$		0.23		Ω
R <sub>ONN</sub>	On Resistance of Nch Tr.	$A/PV_{IN} = 3.6V, I_{LX} = -100\text{mA}$		0.20		Ω
Maxduty	Oscillator Maximum Duty Cycle		100			%
t <sub>start</sub>	Soft-start Time	Refer to the conditions below. <sup>*2</sup>		150	300	μs
I <sub>LXlim</sub>	Lx Current Limit	Refer to the conditions below. <sup>*2</sup>	1400	1700		mA
t <sub>prot</sub>	Protection Delay Time	Refer to the conditions below. <sup>*2</sup>	0.5	1.5	5	ms
V <sub>UVLO1</sub>	UVLO Detector Threshold	$A/PV_{IN} = V_{CE}$	1.9	2.0	2.1	V
V <sub>UVLO2</sub>	UVLO Released Voltage	$A/PV_{IN} = V_{CE}$	2.0	2.1	2.2	V
T <sub>TSD</sub>	Thermal Shutdown Temperature	Junction Temperature		140		°C
T <sub>TSR</sub>	Thermal Shutdown Released Temperature	Junction Temperature		100		°C

Note: Test circuit is "OPEN LOOP" and AGND=PGND=0V unless otherwise specified.

<sup>\*1</sup>  $0.6V \leq V_{OUT} < 0.7V$ : MODE="L" PWM/VFM Alternative Mode.

<sup>\*2</sup>  $A/PV_{IN} = V_{CE} = 3.6V$  ( $V_{SET} \leq 2.6V$ ),  $A/PV_{IN} = V_{CE} = V_{SET} + 1V$  ( $V_{SET} > 2.6V$ )

<sup>\*3</sup> with no auto discharge version only

<sup>\*4</sup> with auto discharge version only

● RP505K001C

(Ta=25°C)

Symbol	Item	Conditions	Min.	Typ.	Max.	Unit
A/PVIN	Operating Input Voltage		2.3		5.5	V
VFB	Feedback Output Voltage	A/PVIN=VCE=3.6V	0.591	0.600	0.609	V
$\Delta V_{FB}/\Delta T$	Feedback Output Voltage Temperature Coefficient	-40°C ≤ Ta ≤ 85°C		±100		ppm/°C
fosc	Oscillator Frequency	Refer to the conditions below. *1	2.00	2.25	2.50	MHz
IDD1	Supply Current 1	A/PVIN=VCE=5.5V, VFB=0.48V		500	840	μA
IDD2	Supply Current 2	A/PVIN=VCE=VOUT=5.5V		40	60	μA
		VMODE=0V		500	840	
Istandby	Standby Current	A/PVIN=5.5V, VCE=0V		0	5	μA
ICEH	CE "H" Input Voltage	A/PVIN=VCE=5.5V	-1	0	1	μA
ICEL	CE "L" Input Voltage	A/PVIN=5.5V, VCE=0V	-1	0	1	μA
IMODEH	Mode "H" Input Current	A/PVIN=VMODE=5.5V, VCE=0V	-1	0	1	μA
IMODEL	Mode "L" Input Current	A/PVIN=5.5V, VCE=VMODE=0V	-1	0	1	μA
IVFBH	VFB "H" Input Current	A/PVIN=VOUT=5.5V, VCE=0V	-1	0	1	μA
IVFBL	VFB "L" Input Current	A/PVIN=5.5V, VCE=VOUT=0V	-1	0	1	μA
ILXLEAKH	LX Leakage Current "H"	A/PVIN=VLX=5.5V, VCE=0V	-1	0	5	μA
ILXLEAKL	LX Leakage Current "L"	A/PVIN=5.5V, VCE=VLX=0V	-5	0	1	μA
VCEH	CE "H" Input Voltage	A/PVIN=5.5V	1.0			V
VCEL	CE "L" Input Voltage	A/PVIN=2.3V			0.4	V
VMODEH	Mode "H" Input Voltage	A/PVIN=VCE=5.5V	1.0			V
VMODEL	Mode "L" Input Voltage	A/PVIN=VCE=2.3V			0.4	V
RONP	On Resistance of Pch Tr.	A/PVIN=3.6V, ILX=-100mA		0.23		Ω
RONN	On Resistance of Nch Tr.	A/PVIN=3.6V, ILX=-100mA		0.20		Ω
Maxduty	Oscillator Maximum Duty Cycle		100			%
tstart	Soft-start Time	Refer to the conditions below. *1		150	300	μs
ILXlim	LX Current Limit	Refer to the conditions below. *1	1400	1700		mA
tprot	Protection Delay Time	Refer to the conditions below. *1	0.5	1.5	5	ms
VUVLO1	UVLO Detector Threshold	A/PVIN=VCE	1.9	2.0	2.1	V
VUVLO2	UVLO Released Voltage	A/PVIN=VCE	2.0	2.1	2.2	V
TTSD	Thermal Shutdown Temperature	Junction Temperature		140		°C
TTSR	Thermal Shutdown Released Temperature	Junction Temperature		100		°C

Test circuit is "OPEN LOOP" and AGND=PGND=0V unless otherwise specified.

\*1 A/PVIN=VCE=3.6V (VSET ≤ 2.6V), A/PVIN=VCE=VSET+1V (VSET>2.6V)

## TYPICAL APPLICATION

(Fixed Output Voltage Type)

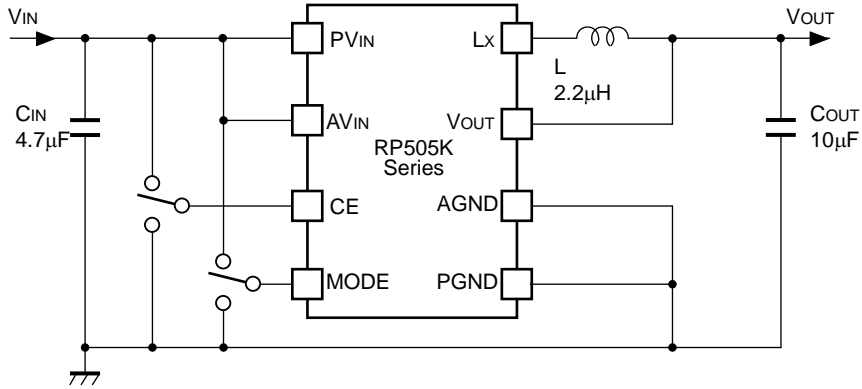

\*) MODE="H" Forced PWM Mode  
 MODE="L" PWM/VFM Alternative Mode

(Adjustable Output Voltage Type)

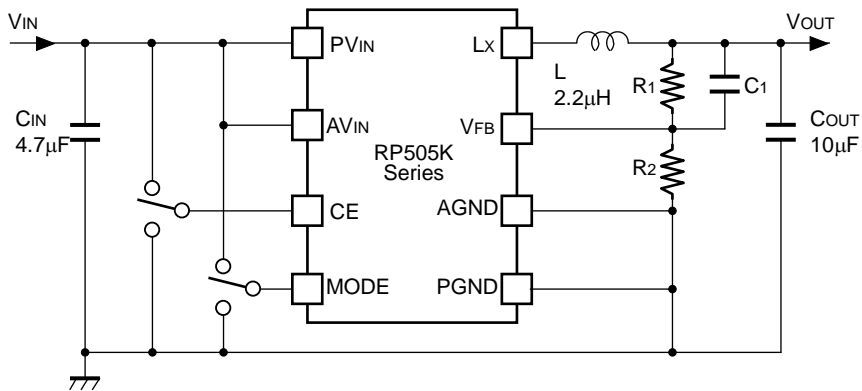

\*) MODE="H" Forced PWM Mode  
 MODE="L" PWM/VFM Alternative Mode

Symbol	Recommendation components		
C <sub>IN</sub>	4.7µF	Ceramic	C1608JB0J475K(TDK)
C <sub>OUT</sub>	10µF	Ceramic	C1608JB0J106M(TDK)
L	2.2µH	Inductor	MIPSA2520D2R2(FDK)



## TECHNICAL NOTES

When you use these ICs, consider the following issues:

- Set the same level as AGND and PGND.
- Set the same level as AV<sub>IN</sub> and PV<sub>IN</sub>.
- Place the external parts as close as possible to the IC by using a short as possible wiring. Especially, place the capacitor as close as possible to the PV<sub>IN</sub> and PGND pins. Ensure the V<sub>DD</sub> and GND lines are sufficiently robust. If their impedances are too high, the electrical potential of the inside of the IC could be fluctuated by switching current, and noise pickup or unstable operation could be the results. Please note that the large switching current flows through the V<sub>DD</sub> line, the GND line, an inductor, the L<sub>X</sub>, and the V<sub>OUT</sub> line. Separate the line between the V<sub>OUT</sub> pin and an inductor (A and B versions), and the line between a resistor for setting output voltage (R1) and an inductor (C version), from the line connected to the load. Use a ceramic capacitor with the small ESR value.
- The recommended capacitance value for the C<sub>IN</sub> capacitor connected between the PV<sub>IN</sub> and PGND pins is 4.7μF or more. Also, the recommended capacitance value for the C<sub>OUT</sub> capacitor is 10μF.
- The Inductance value should be set within the range of 1.0 to 2.2μH. However, the inductance value is limited by output voltage, so please refer to the table below. For stable operation, the phase compensation is set according to the specified inductance value and the specified C<sub>OUT</sub> capacitance value. Select the inductor with low DC resistance, with large permissive current, with high resistant to magnetic saturation. Select the inductance value considering the load current by the conditions of use. If the inductance value is small, the L<sub>X</sub> peak current may increase along with the increase of load current. When the L<sub>X</sub> peak current reaches to the “L<sub>X</sub> limit current”, the current limit circuit may be activated.

### [Inductance Range vs. Output Voltage Range]

V <sub>OUT</sub> [V]	L=1.0μH	L=1.5μH	L=2.2μH
0.6~1.55	○	○	○
1.6~2.3	×	○	○
2.35~3.3	×	×	○

- Please note that Current limit circuit and Latch type protection circuit could be affected by self-heating or heat dissipation environment.
- For adjustable output voltage type (C version), the output voltage (V<sub>OUT</sub>) is adjustable by changing the R<sub>1</sub> and R<sub>2</sub> values as follows.

$$V_{OUT} = V_{FB} \times (R_1 + R_2) / R_2 \quad (0.8V \leq V_{OUT} \leq 3.3V)$$

If the R<sub>1</sub> and R<sub>2</sub> values are large, the impedances of the V<sub>FB</sub> pin become large and could be easily affected by noise. Therefore, set the R<sub>2</sub> value to 220kΩ or less. If the operation becomes unstable due to the high impedance, the impedance should be decreased. The C<sub>1</sub> value can be calculated by the following formula. Please use the value close to the calculation result.

$$C_1 = 4.84 \times 10^{-6} / R_2 \text{ [F]}$$

\* The performance of power supply circuits using this IC largely depends on the peripheral circuits. Please be very careful when setting the peripheral parts. When designing the peripheral circuits of each part, PCB patterns, and this IC, please do not exceed the rated values (Voltage, Current, Power).

## Operation of Step-down DC/DC Converter and Output Current

The DC/DC converter charges energy in the inductor when Lx transistor is ON, and discharges the energy from the inductor when Lx transistor is OFF and controls with less energy loss, so that a lower output voltage than the input voltage is obtained. The operation will be explained with reference to the following diagrams:

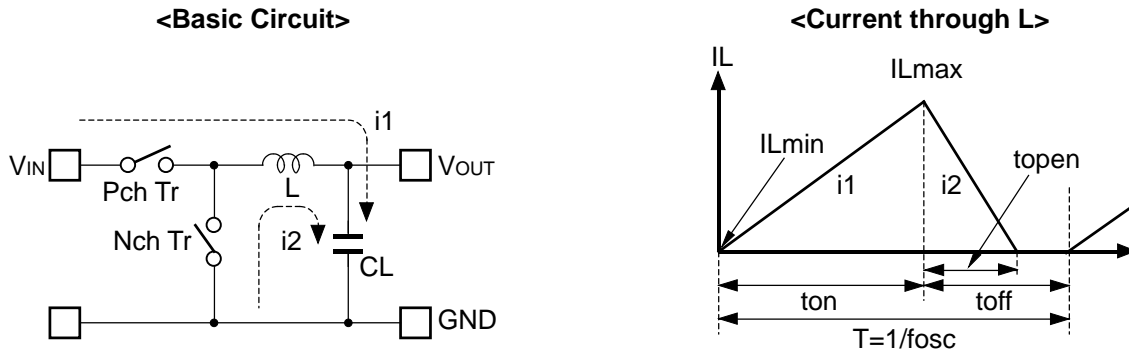

- Step 1: Pch Tr. turns on and current IL (=i1) flows, and energy is charged into CL. At this moment, IL increases from ILmin (=0) to reach ILmax in proportion to the on-time period (ton) of Pch Tr.
- Step 2: When Pch Tr. turns off, Synchronous rectifier Nch Tr. turns on in order that L maintains IL at ILmax, and current IL (=i2) flows.
- Step 3: IL (=i2) decreases gradually and reaches IL=ILmin=0 after a time period of topen, and Nch Tr. turns off. Provided that in the continuous mode, next cycle starts before IL becomes to 0 because toff time is not enough. In this case, IL value increases from this ILmin (>0).

In the case of PWM control system, the output voltage is maintained by controlling the on-time period (ton), with the oscillator frequency (fosc) being maintained constant.

The maximum value (ILmax) and the minimum value (ILmin) of the current flowing through the inductor are the same as those when Pch Tr. turns on and off.

The difference between ILmax and ILmin, which is represented by ΔI:

$$\Delta I = I_{Lmax} - I_{Lmin} = V_{OUT} \times t_{open} / L = (V_{IN} - V_{OUT}) \times t_{on} / L \dots\dots\dots \text{Equation 1}$$

Wherein,

$$T = 1 / f_{osc} = t_{on} + t_{off}$$

$$\text{duty (\%)} = t_{on} / T \times 100 = t_{on} \times f_{osc} \times 100$$

$$t_{open} \leq t_{off}$$

In Equation 1,  $V_{OUT} \times t_{open} / L$  and  $(V_{IN} - V_{OUT}) \times t_{on} / L$  respectively show the change of the current at "ON", and the change of the current at "OFF".

## Discontinuous mode and Continuous mode

When the output current ( $I_{OUT}$ ) is relatively small,  $t_{open} < t_{off}$  as illustrated in the above diagram. In this case, the energy is charged in the inductor during the time period of  $t_{on}$  and is discharged in its entirety during the time period of  $t_{off}$ , therefore  $I_{Lmin}$  becomes to zero ( $I_{Lmin}=0$ ). When  $I_{OUT}$  is gradually increased, eventually,  $t_{open}$  becomes to  $t_{off}$  ( $t_{open}=t_{off}$ ), and when  $I_{OUT}$  is further increased,  $I_{Lmin}$  becomes larger than zero ( $I_{Lmin}>0$ ). The former mode is referred to as the discontinuous mode and the latter mode is referred to as continuous mode.

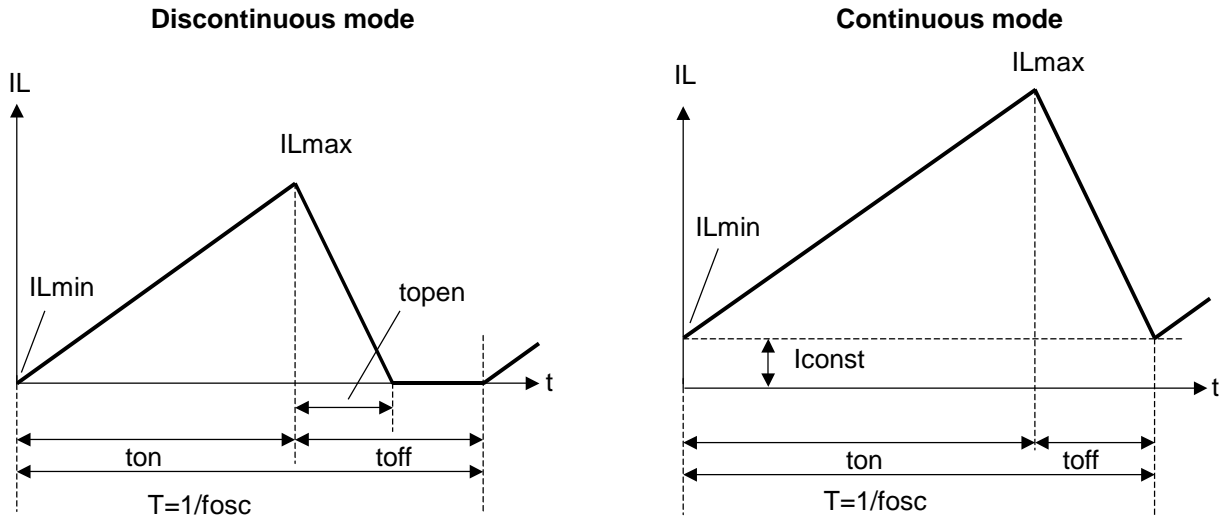

In the continuous mode, when Equation 1 is solved for  $t_{on}$  and assumed that the solution is  $t_{onc}$ ,

$$t_{onc} = T \times V_{OUT} / V_{IN} \dots \dots \dots \text{Equation 2}$$

When  $t_{on} < t_{onc}$ , the mode is the discontinuous mode, and when  $t_{on} = t_{onc}$ , the mode is the continuous mode.

**Forced PWM Mode Control and VFM Mode Control**

By setting the Mode pin to H, the IC switches the frequency at the fixed rate to reduce noise even when output load is light. Therefore, when  $I_{OUT}$  is  $\Delta I_L/2$  or less,  $I_{Lmin}$  becomes less than 0. That is, the IC discharges the electrical charge in CL to the IC side until the IL changes from  $I_{Lmin}$  to 0 during  $t_{on}$  time, and the IL changes from 0 to  $I_{Lmin}$  during  $t_{off}$  time.

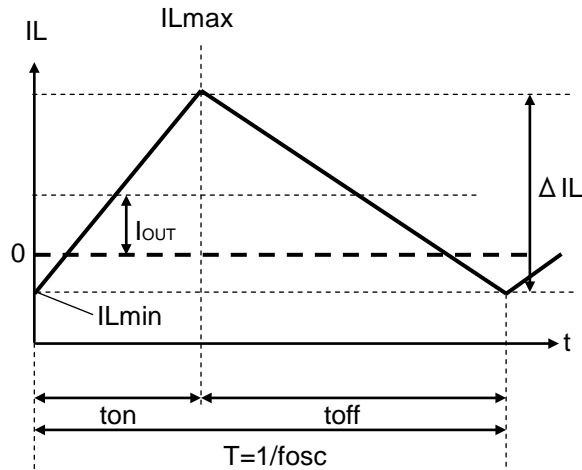
**Forced PWM Mode Control**

By setting the Mode pin to L, the IC automatically switches into VFM mode for high efficiency when output load is light. Under VFM mode,  $t_{on}$  indicates the time until the IC reaches to the pre-set  $I_{Lmax}$ . With the RP505K Series,  $I_{Lmax}$  during VFM control is pre-set to 280mA or so. However, even if the IC is not reached to  $I_{Lmax}$  yet,  $t_{on}$  turns off when it becomes around 1.5 times of  $T=1/f_{osc}$ .

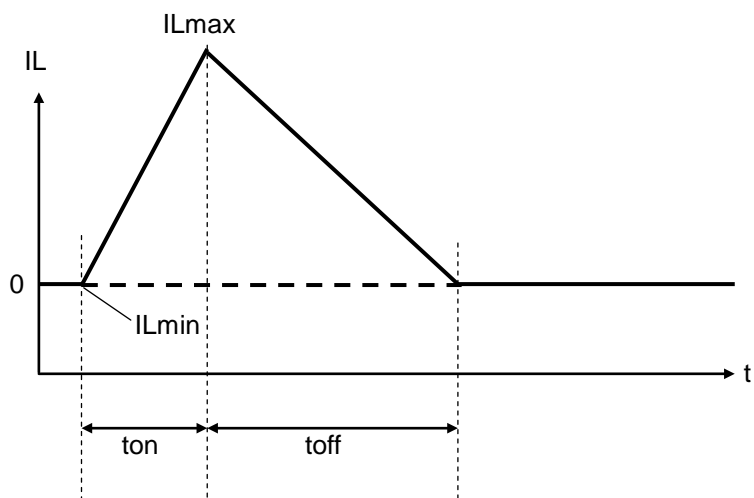
**VFM Mode Control**

## Output Current and Selection of External Components

The relation between the output current and external components is as follows:

(Wherein, Ripple Current p-p value is described as  $I_{RP}$ , ON resistance of Pch Tr. and Nch Tr. of  $L_x$  are respectively described as  $R_{ONP}$  and  $R_{ONN}$ , and the DC resistor of the inductor is described as  $R_L$ .)

When Pch Tr. of  $L_x$  is ON:

$$V_{IN} = V_{OUT} + (R_{ONP} + R_L) \times I_{OUT} + L \times I_{RP} / t_{on} \dots\dots\dots \text{Equation 3}$$

When Pch Tr. of  $L_x$  is "OFF" (Nch Tr. is "ON"):

$$L \times I_{RP} / t_{off} = R_{ONN} \times I_{OUT} + V_{OUT} + R_L \times I_{OUT} \dots\dots\dots \text{Equation 4}$$

Put Equation 4 to Equation 3 and solve for ON duty of Pch transistor,  $D_{ON} = t_{on} / (t_{off} + t_{on})$ ,

$$D_{ON} = (V_{OUT} + R_{ONN} \times I_{OUT} + R_L \times I_{OUT}) / (V_{IN} + R_{ONN} \times I_{OUT} - R_{ONP} \times I_{OUT}) \dots\dots\dots \text{Equation 5}$$

Ripple Current is as follows:

$$I_{RP} = (V_{IN} - V_{OUT} - R_{ONP} \times I_{OUT} - R_L \times I_{OUT}) \times D_{ON} / f_{osc} / L \dots\dots\dots \text{Equation 6}$$

wherein, peak current that flows through  $L$ , and  $L_x$  Tr. is as follows:

$$I_{Lxmax} = I_{OUT} + I_{RP} / 2 \dots\dots\dots \text{Equation 7}$$

\*Consider  $I_{Lxmax}$ , condition of input and output and select external components.

\*The above explanation is directed to the calculation in an ideal case in continuous mode.

## TIMING CHART

### (1) Soft-start Time

- In the case of starting this IC with CE

In the case of starting this IC with CE, the operation can be as in the timing chart below.

When the voltage of CE pin ( $V_{CE}$ ) is beyond the threshold level, the operation of the IC starts. The threshold voltage of CE pin is in between CE "H" input voltage ( $V_{CEH}$ ) and CE "L" input voltage ( $V_{CEL}$ ) described in the electrical characteristics table. Soft-start circuit operates, and after the certain time, the reference voltage inside the IC ( $V_{REF}$ ) is rising gradually up to the constant value.

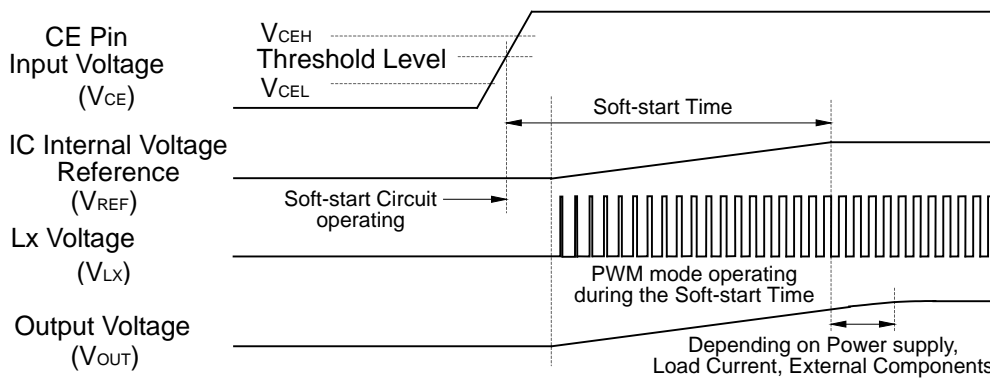

Soft-start time is the time interval from soft-start circuit starting point to the reference voltage level reaching point up to this constant level.

\*Soft-start time is not always equal to the turn-on speed of DC/DC converter.

The power supply capacity for this IC, load current, inductance and capacitance values affect the turn-on speed.

- In the case of starting with power supply

In the case of starting with power supply, when the input voltage ( $V_{IN}$ ) is larger than UVLO released voltage ( $V_{UVLO2}$ ), soft-start circuit operates, and after that, the same explanation above is applied to the operation.

Soft-start time is the time interval from soft-start circuit starting point to the reference voltage level reaching point up to this constant level.

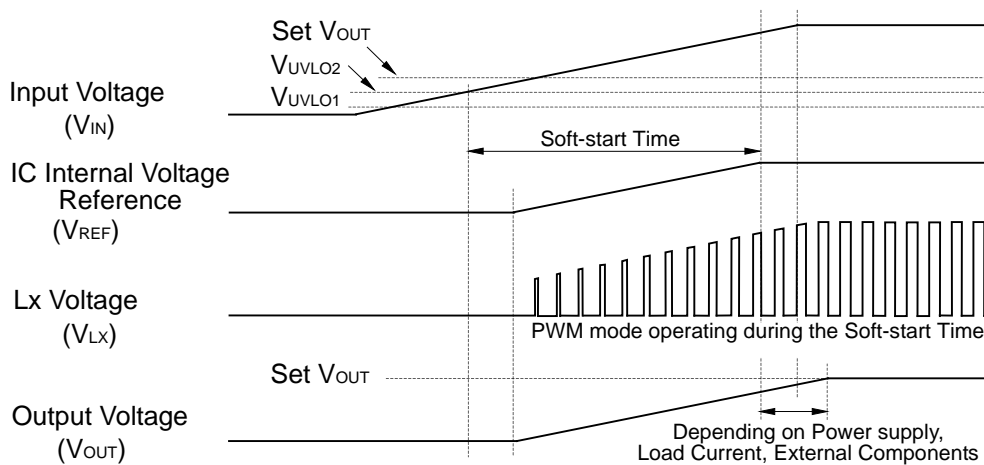

\*Turn-on speed is affected by next conditions;

(a) Input Voltage ( $V_{IN}$ ) rising speed depending on the power supplier to the IC and input capacitor  $C_{IN}$ .

(b) Output Capacitor  $C_{OUT}$  value and load current value.

**(2) Under Voltage Lockout (UVLO) Circuit**

The step-down DC/DC converter stops and ON duty becomes 100%, if input voltage ( $V_{IN}$ ) becomes less than the set output voltage (Set  $V_{OUT}$ ), the output voltage ( $V_{OUT}$ ) gradually drops according to the input voltage ( $V_{IN}$ ). If the input voltage drops more and becomes less than UVLO detector threshold ( $V_{UVLO1}$ ), the under voltage lockout circuit (UVLO) operates, the IC internal reference voltage ( $V_{REF}$ ) stops, switching transistors turn off and the output voltage drops according to the load and output capacitor  $C_{OUT}$  value. To restart the normal operation, the input voltage ( $V_{IN}$ ) must be more than the UVLO released voltage ( $V_{UVLO2}$ ). The timing chart below describes the operation with varying the input voltage ( $V_{IN}$ ).

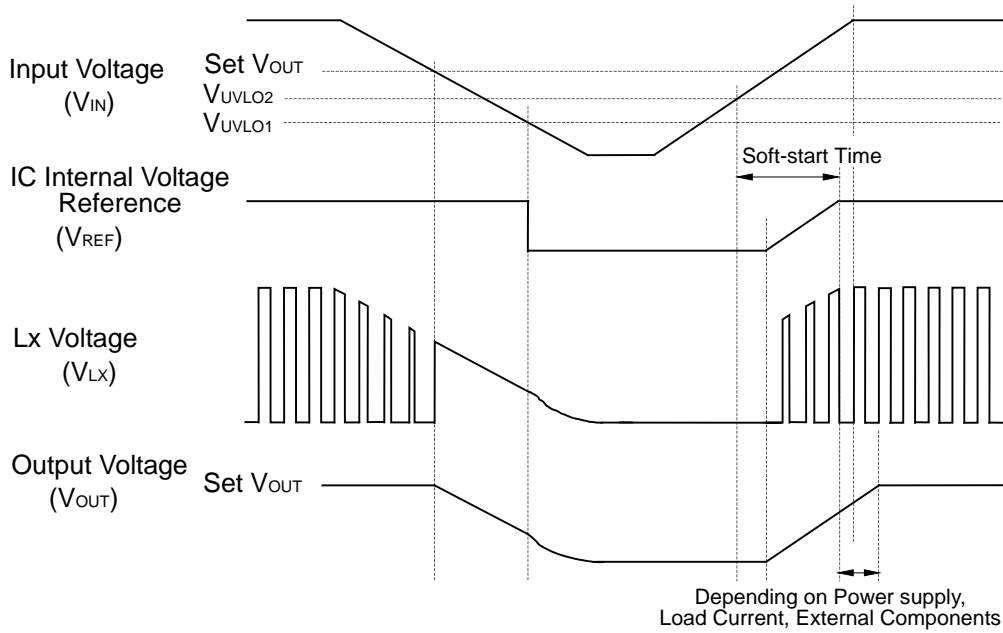

\*Actually, the waveform of  $V_{OUT}$  at UVLO working and releasing varies depending on the initial voltage of  $C_{OUT}$  and load current situation.

**(3) Over Current Protection Circuit, Latch Type Protection Circuit**

Over current protection circuit supervises the inductor peak current (the current flowing through Pch transistor) in each switching cycle, and if the current exceeds the L<sub>x</sub> current limit (I<sub>Lxlim</sub>), turns off Pch transistor. The L<sub>x</sub> current limit of RP505K is Typ.1700mA.

Latch type protection circuit latches the built-in driver to the OFF state and stops the operation of DC/DC converter if the over current status continues or the output voltage continues being the half of the setting voltage for equal or longer than protection delay time (t<sub>prot</sub>).

\*L<sub>x</sub> current limit (I<sub>Lxlim</sub>) and protection delay time (t<sub>prot</sub>) could be easily affected by self-heating or ambient environment. If the input voltage (V<sub>IN</sub>) drops drastically or becomes unstable due to short-circuit, the protection operation and protection delay time may be affected.

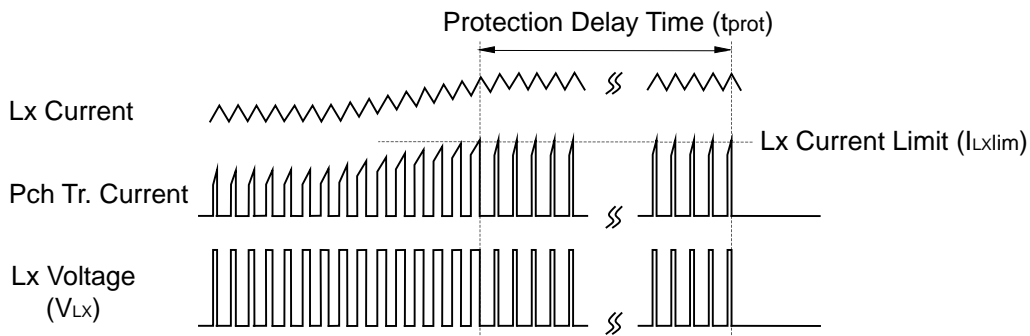

To release the condition of latch type protection, restart this IC by inputting "L" signal to CE pin, or restart this IC with power-on or make the supply voltage lower than UVLO detector threshold (V<sub>UVLO1</sub>) level.

The timing chart shown below describes the changing process of input voltage rising, stable operating, operating with large current, reset with CE pin, stable operating, input voltage falling, input voltage recovering, and stable operating.

Point(1) : If the large current flows through the circuit or the IC goes into low output voltage condition due to short-circuit or other reasons, the latch type protection circuit latches the built-in driver to OFF state after the protection delay time (t<sub>prot</sub>). Then, V<sub>Lx</sub> becomes "L" and the output voltage turns OFF. In this timing chart below, the latch protective circuit can be released by once putting the IC into "L" with the CE pin and then into "H" again.

Point(2) : The latch type protection can be released by UVLO reset by making the input voltage lower than the UVLO detector threshold(V<sub>UVLO1</sub>)

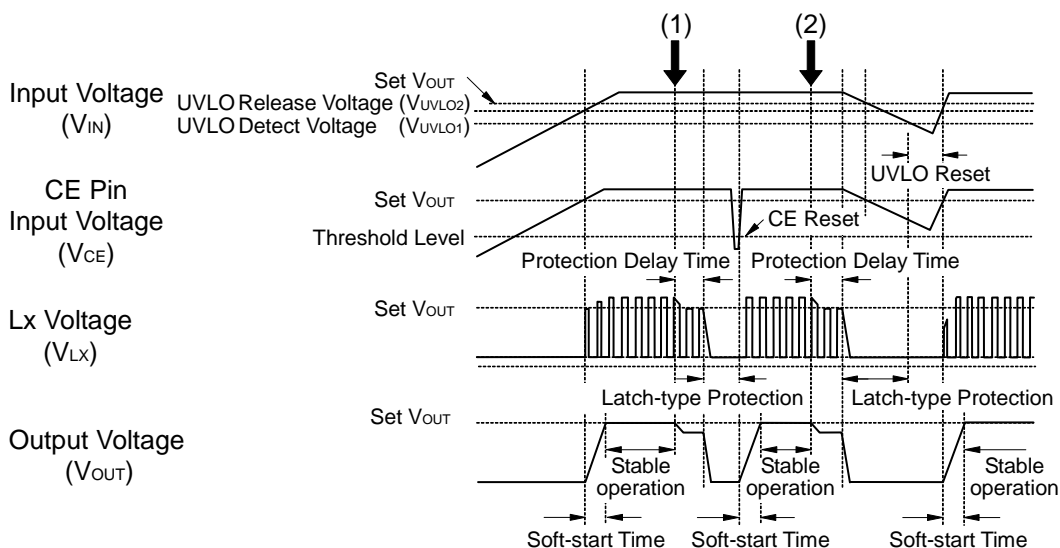



# TYPICAL CHARACTERISTICS

## 1) Output Voltage vs. Output Current

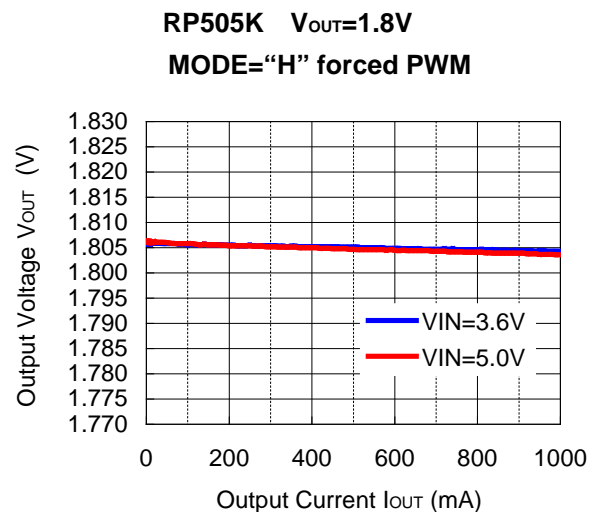
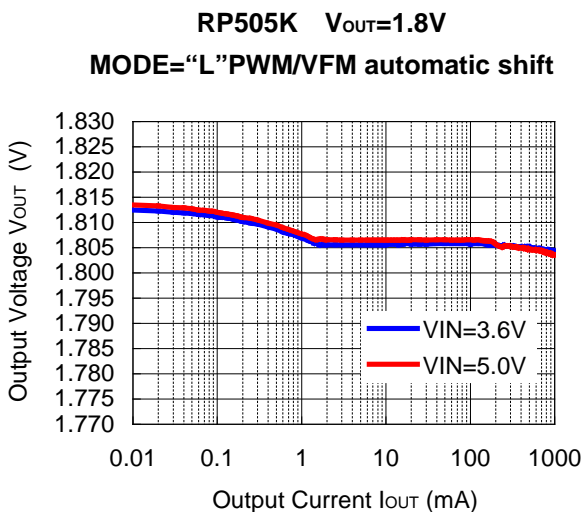
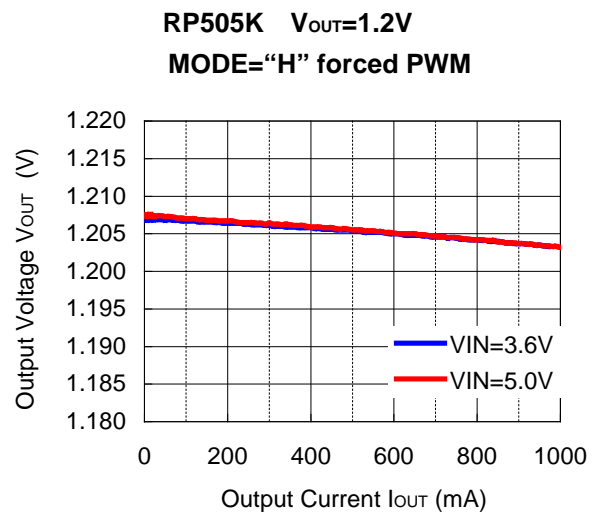
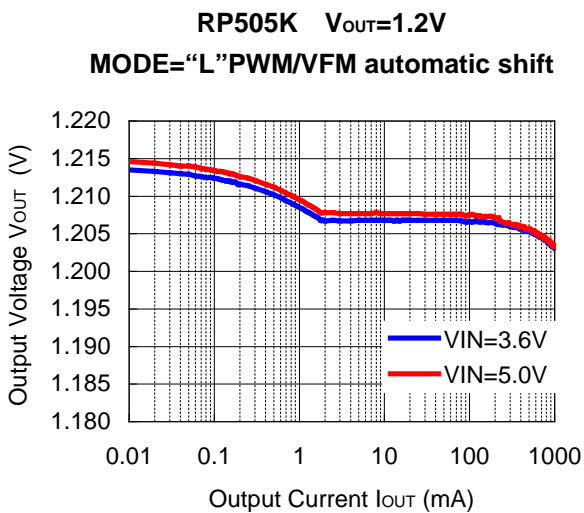
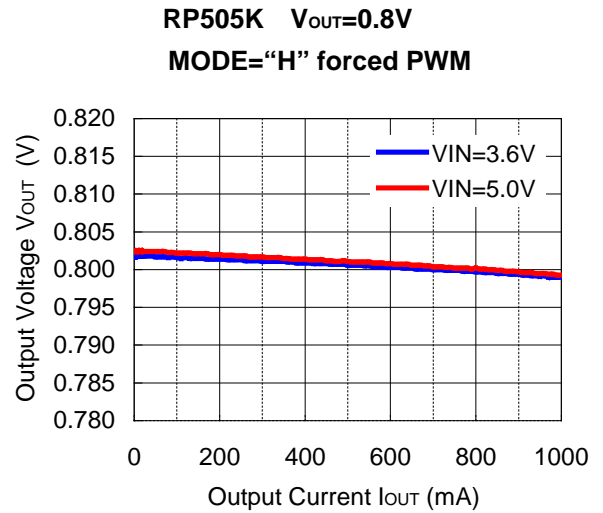
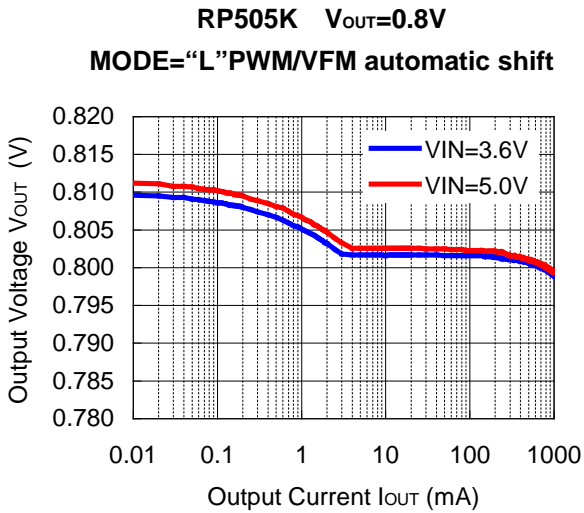

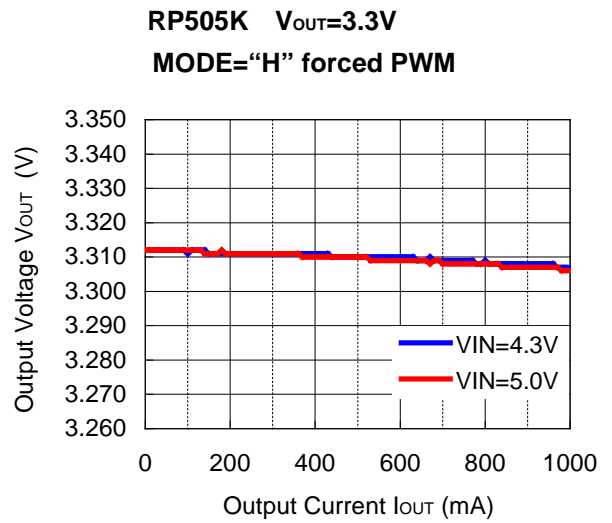
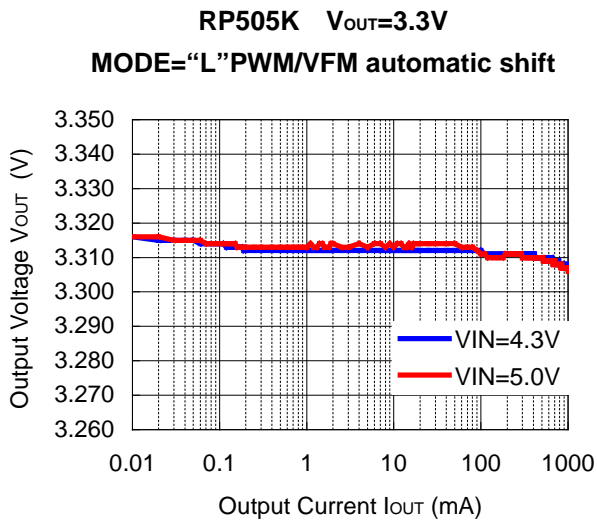

**2) Output Voltage vs. Input Voltage**

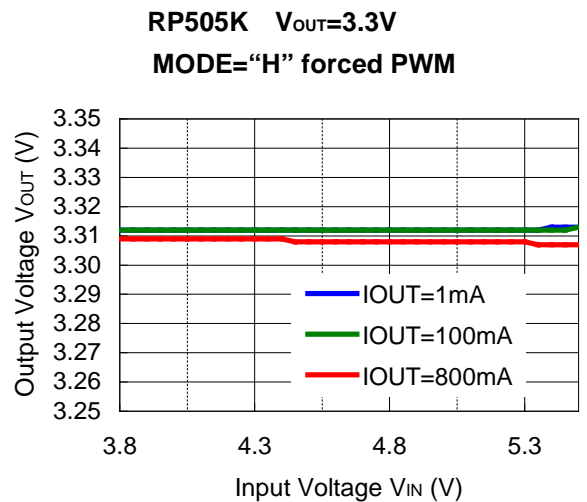
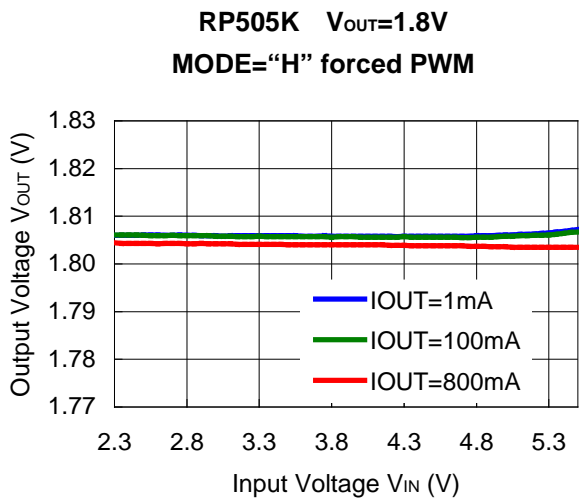
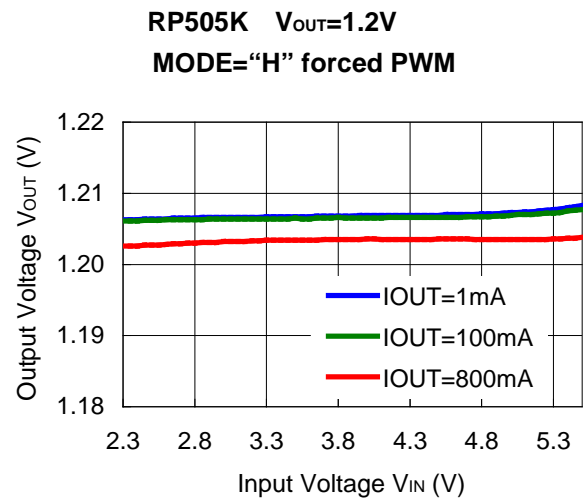
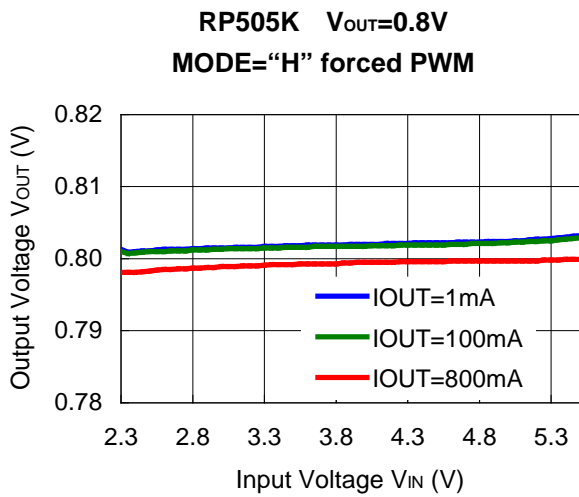

3) Output Voltage vs. Temperature

RP505K181A/B

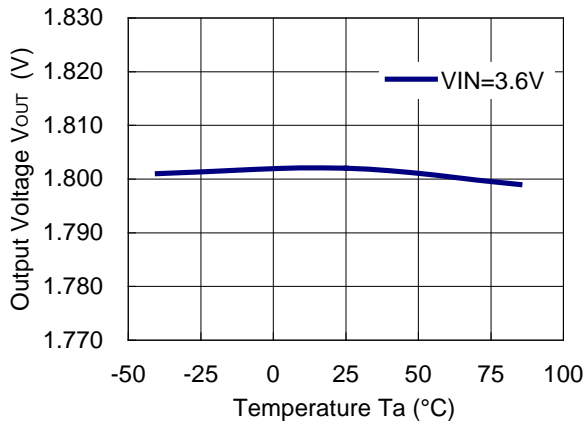

4) Feedback Voltage vs. Temperature

RP505K001C

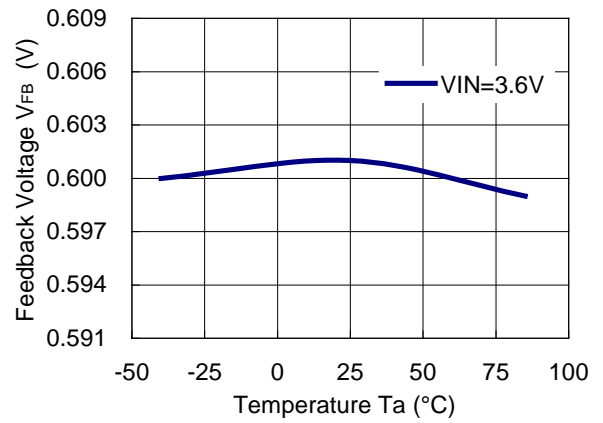

5) Efficiency vs. Output Current

RP505K V<sub>OUT</sub>=0.8V

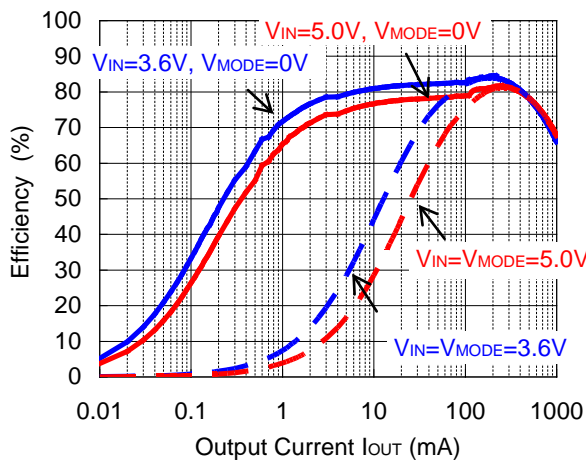

RP505K V<sub>OUT</sub>=1.2V

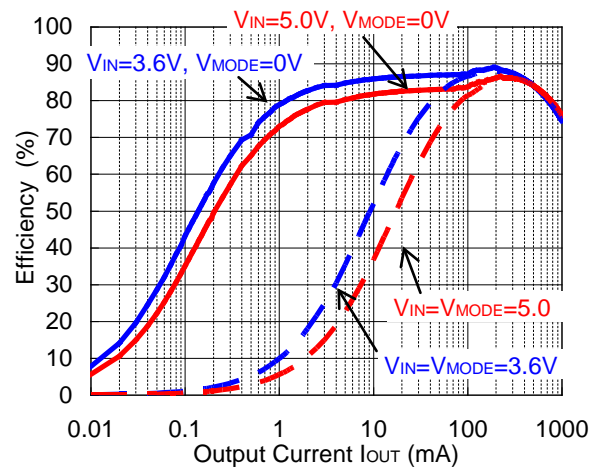

RP505K V<sub>OUT</sub>=1.8V

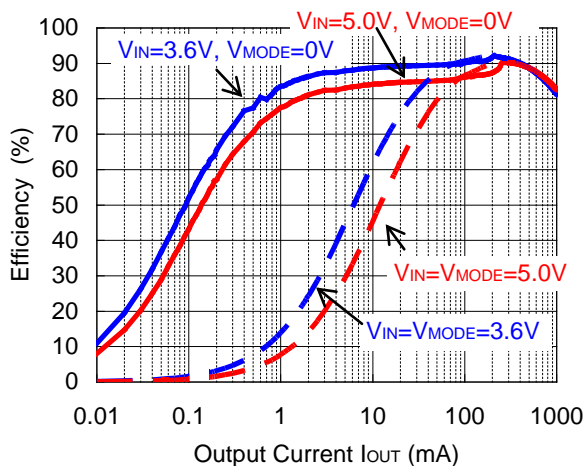

RP505K V<sub>OUT</sub>=3.3V

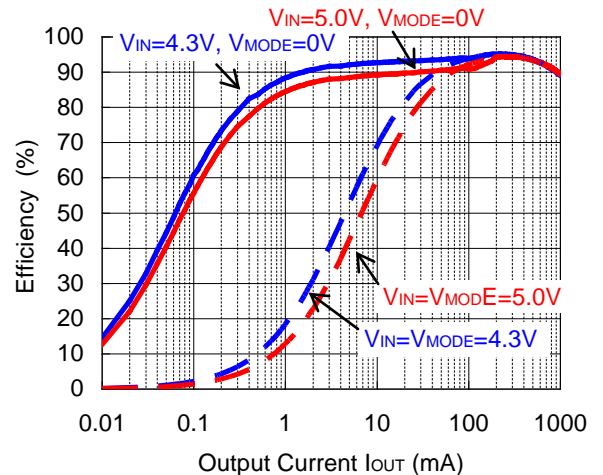

6) Supply Current vs. Temperature  
 RP505K  $V_{OUT}=1.8V(V_{IN}=5.5V)$   
 MODE="L" PWM/VFM automatic shift

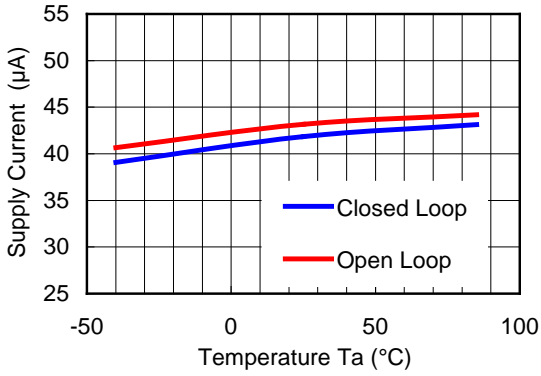

7) Supply Current vs. Input Voltage  
 RP505K  $V_{OUT}=1.8V$   
 MODE="L" PWM/VFM automatic shift

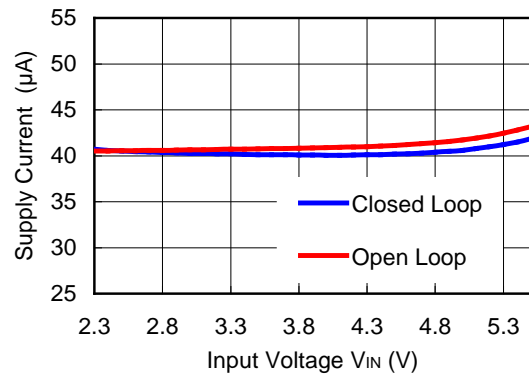

8) DC/DC Output Waveform  
 RP505K  $V_{OUT}=0.8V(V_{IN}=3.6V)$   
 MODE="L" PWM/VFM automatic shift

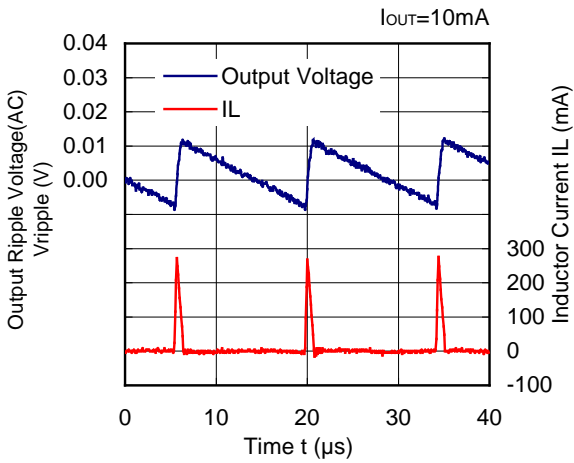

RP505K  $V_{OUT}=0.8V(V_{IN}=3.6V)$   
 MODE="H" forced PWM

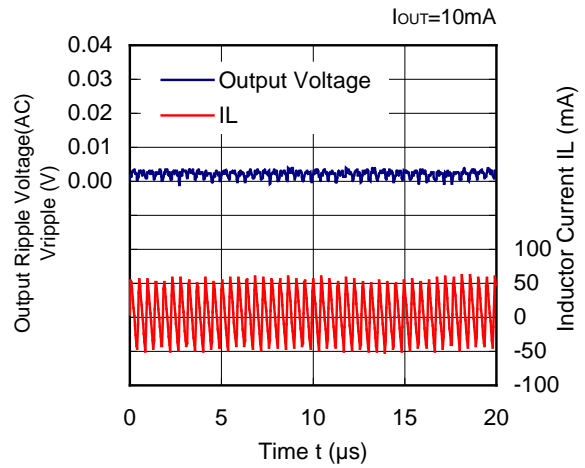

RP505K  $V_{OUT}=1.2V(V_{IN}=3.6V)$   
 MODE="L" PWM/VFM automatic shift

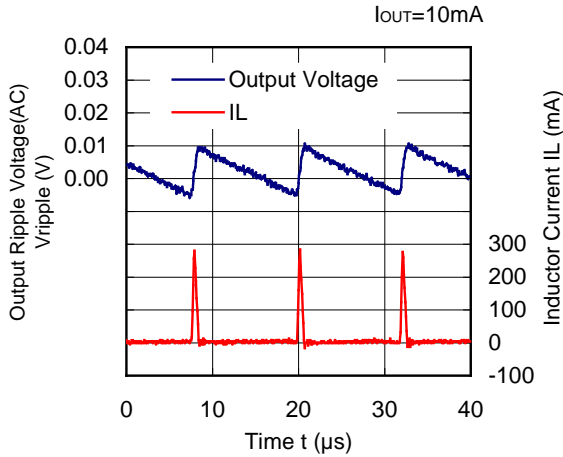

RP505K  $V_{OUT}=1.2V(V_{IN}=3.6V)$   
 MODE="H" forced PWM

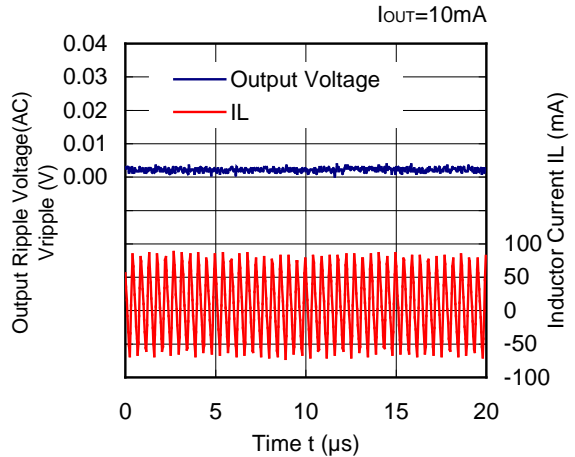

**RP505K  $V_{OUT}=1.8V(V_{IN}=3.6V)$   
MODE="L" PWM/VFM automatic shift**

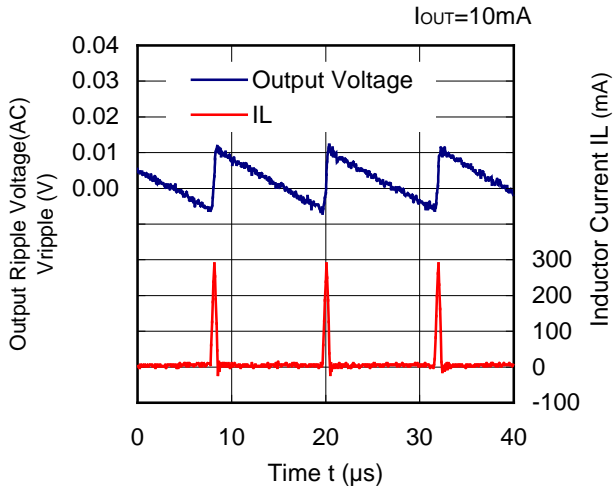

**RP505K  $V_{OUT}=1.8V(V_{IN}=3.6V)$   
MODE="H" forced PWM**

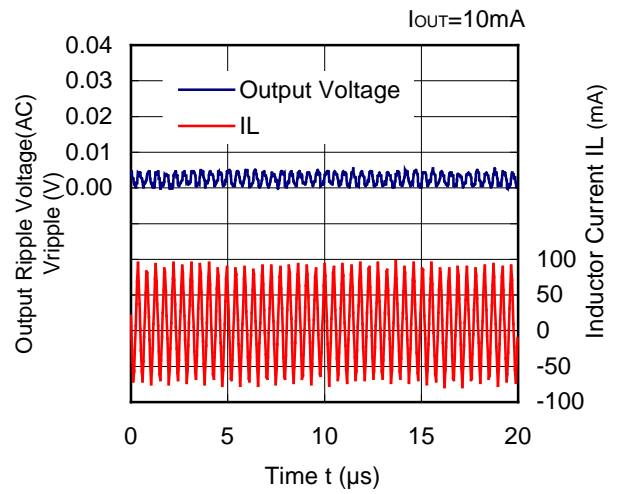

**RP505K  $V_{OUT}=3.3V(V_{IN}=5.0V)$   
MODE="L" PWM/VFM automatic shift**

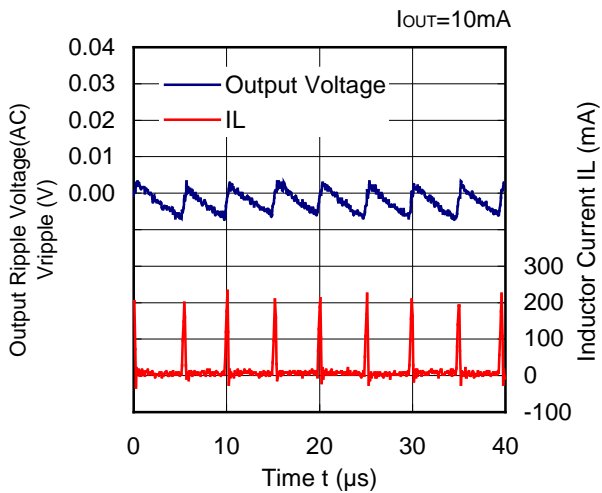

**RP505K  $V_{OUT}=3.3V(V_{IN}=5.0V)$   
MODE="H" forced PWM**

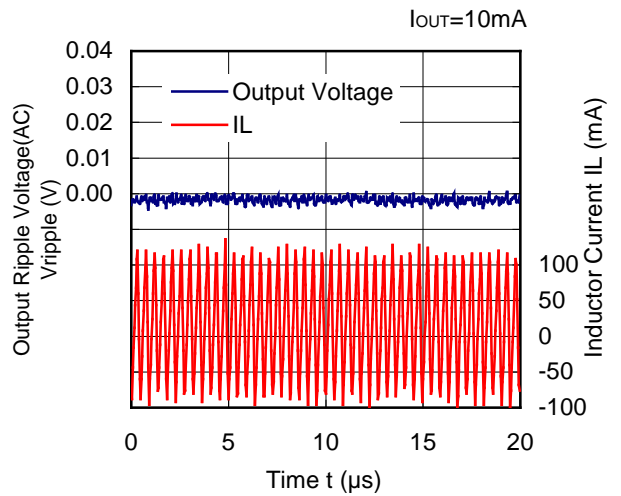

9) Oscillator Frequency vs. Temperature

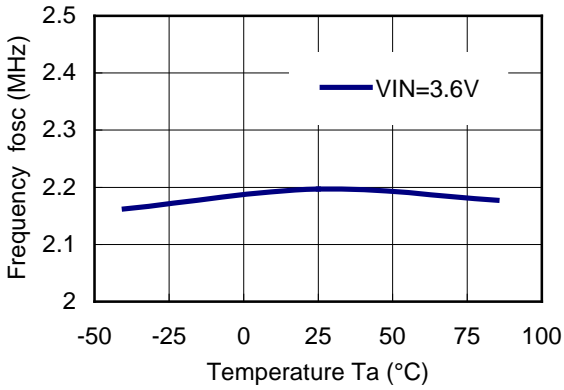

10) Oscillator Frequency vs. Input Voltage

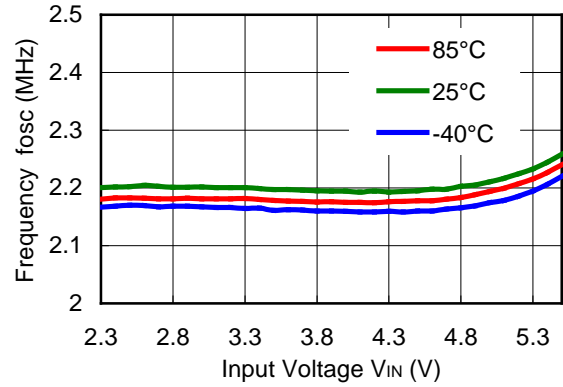

11) Soft-start Time vs. Temperature

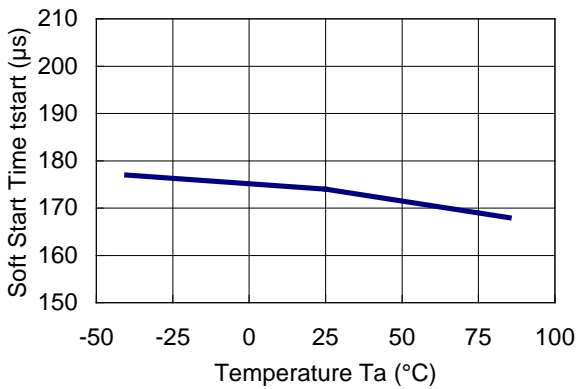

12) UVLO Detector Threshold / Released Voltage vs. Temperature

UVLO Detector Threshold

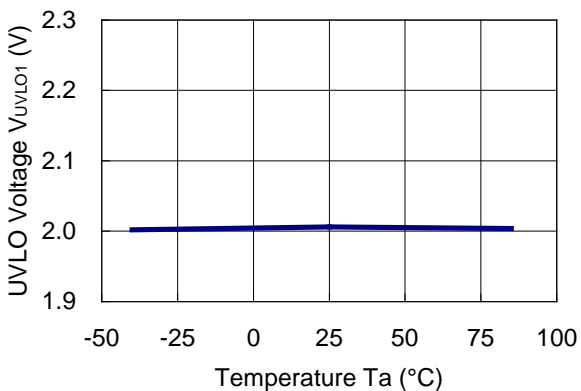

UVLO Released Voltage

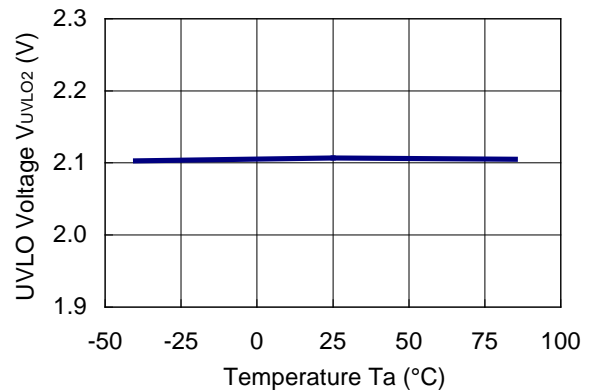

13) CE Input Voltage vs. Temperature

CE“H” Input Voltage ( $V_{IN}=5.5V$ )

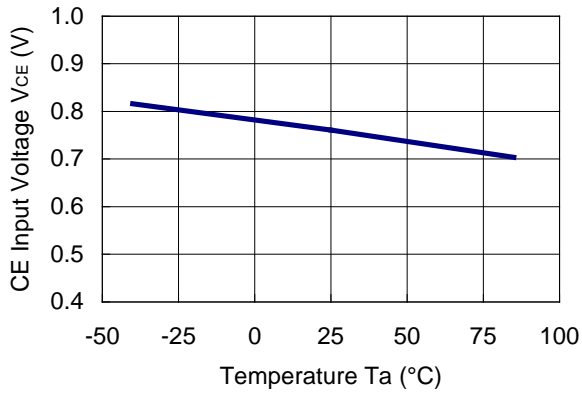

CE“L” Input Voltage ( $V_{IN}=2.3V$ )

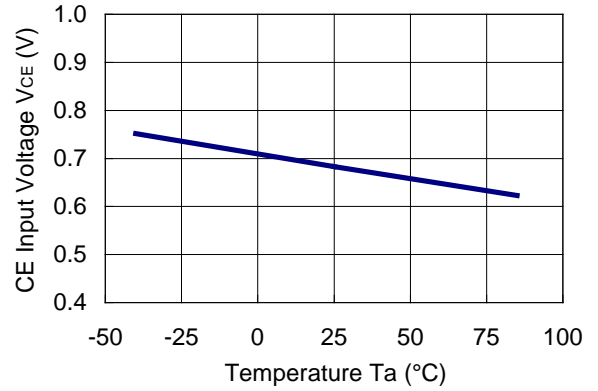

14) Lx Current Limit vs. Temperature

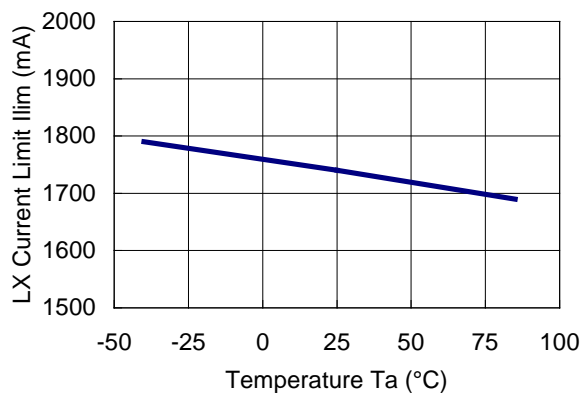

15) Nch Tr. ON Resistance vs. Temperature

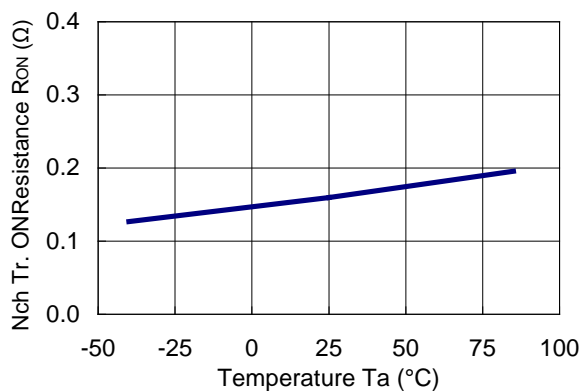

16) Pch Tr. ON Resistance vs. Temperature

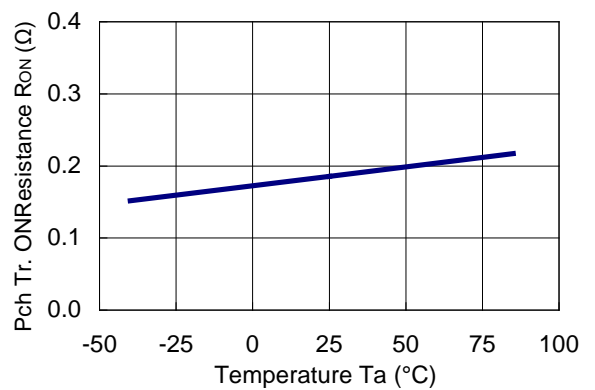

17) Load Transient Response

RP505K081A/B ( $V_{IN}=3.6V$ )  
MODE="L" PWM/VFM automatic shift

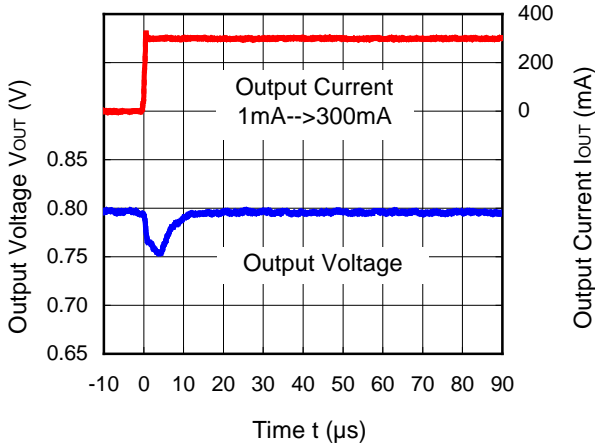

RP505K081A/B ( $V_{IN}=3.6V$ )  
MODE="L" PWM/VFM automatic shift

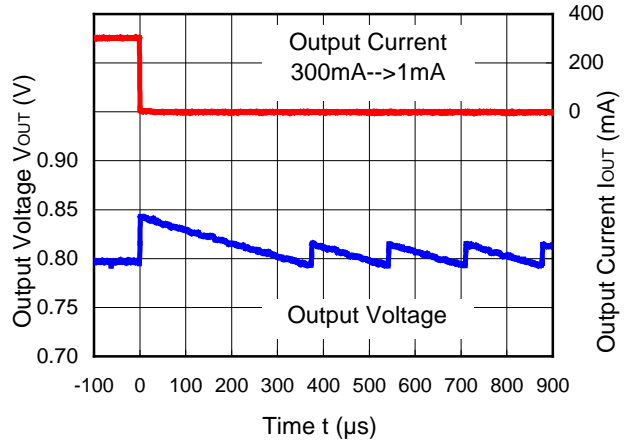

RP505K081A/B ( $V_{IN}=3.6V$ )  
MODE="H" forced PWM

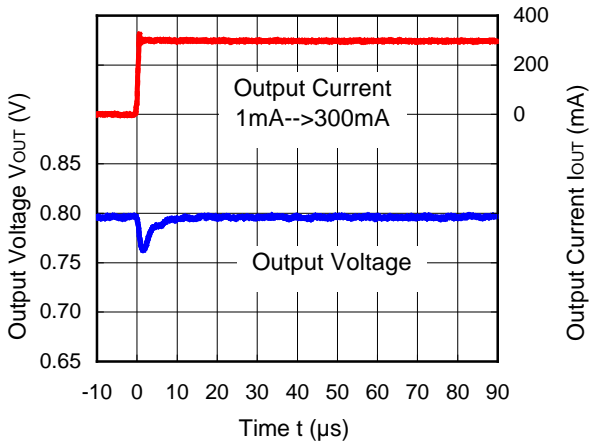

RP505K081A/B ( $V_{IN}=3.6V$ )  
MODE="H" forced PWM

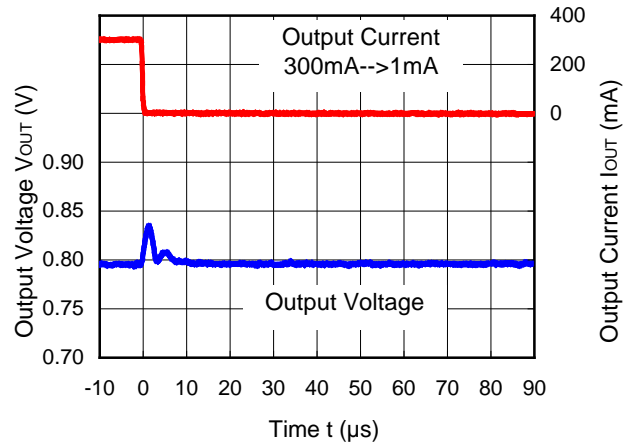

RP505K081A/B ( $V_{IN}=3.6V$ )

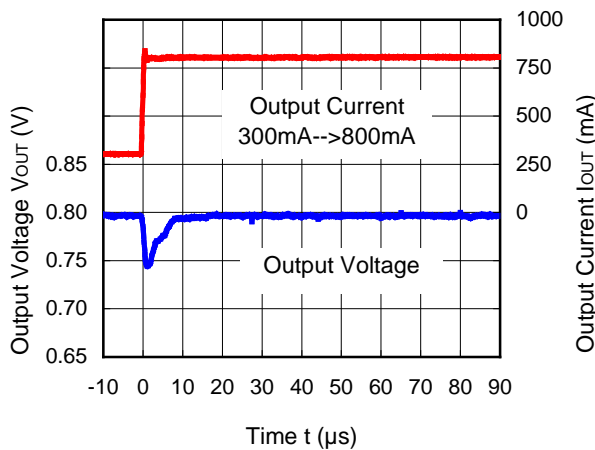

RP505K081A/B ( $V_{IN}=3.6V$ )

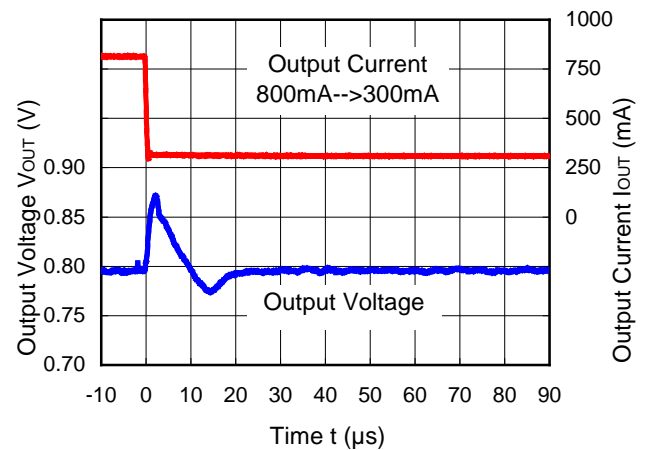



**RP505K181A/B (V<sub>IN</sub>=3.6V)**  
**MODE="L" PWM/VFM automatic shift**

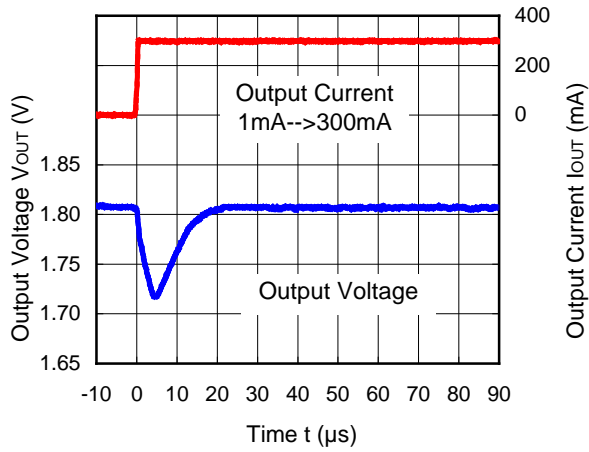

**RP505K181A/B (V<sub>IN</sub>=3.6V)**  
**MODE="L" PWM/VFM automatic shift**

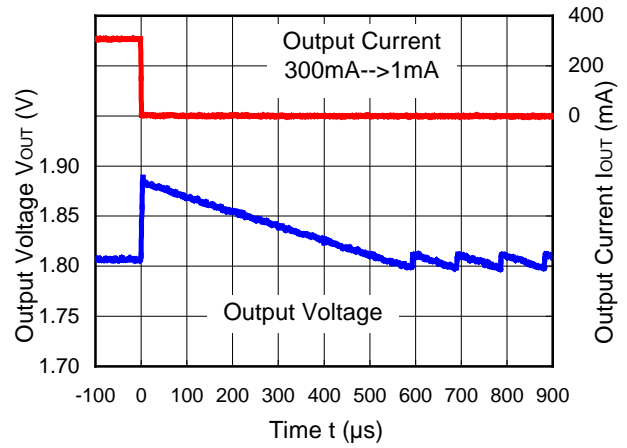

**RP505K181A/B (V<sub>IN</sub>=3.6V)**  
**MODE="H" forced PWM**

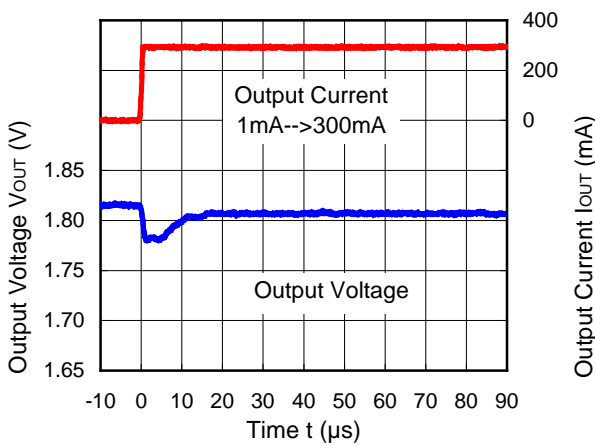

**RP505K181A/B (V<sub>IN</sub>=3.6V)**  
**MODE="H" forced PWM**

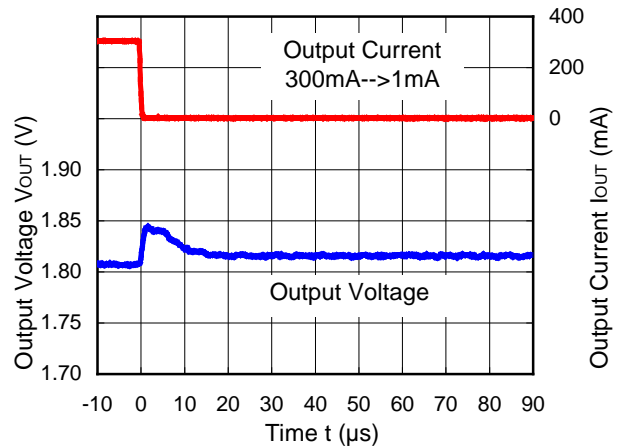

**RP505K181A/B (V<sub>IN</sub>=3.6V)**

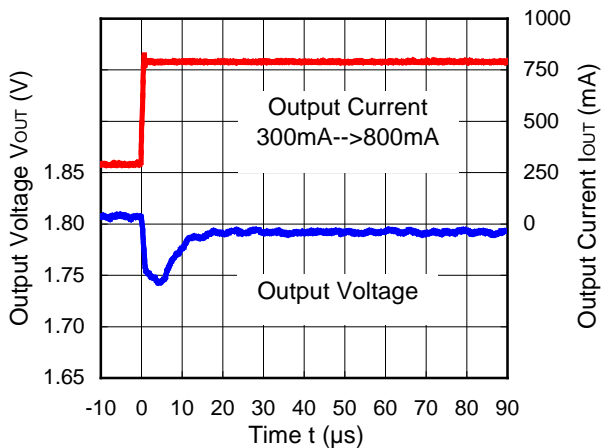

**RP505K181A/B (V<sub>IN</sub>=3.6V)**

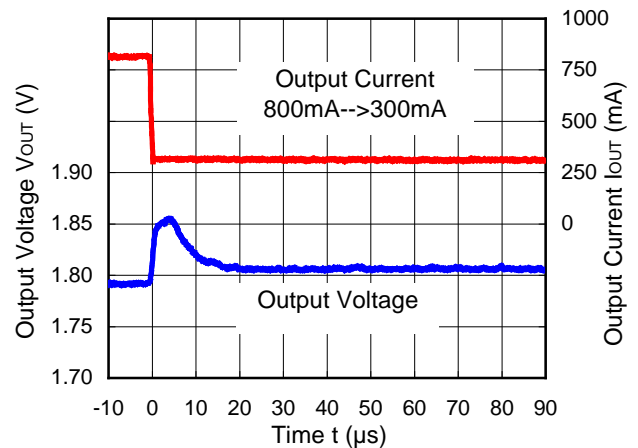

**RP505K331A/B (V<sub>IN</sub>=5.0V)**  
**MODE="L" PWM/VFM automatic shift**

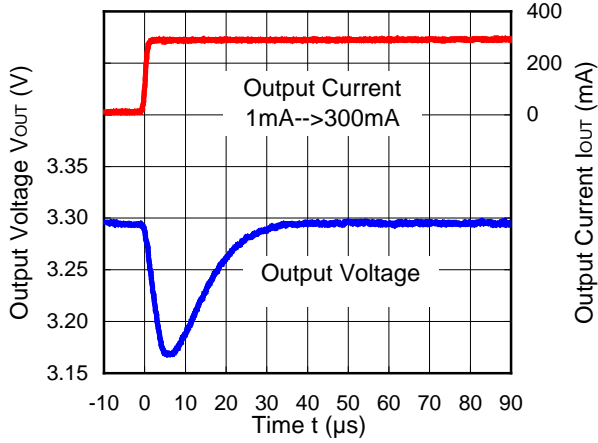

**RP505K331A/B (V<sub>IN</sub>=5.0V)**  
**MODE="L" PWM/VFM automatic shift**

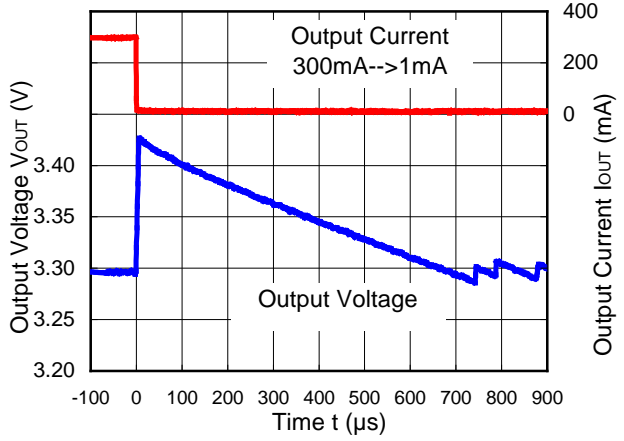

**RP505K331A/B (V<sub>IN</sub>=5.0V)**  
**MODE="H" forced PWM**

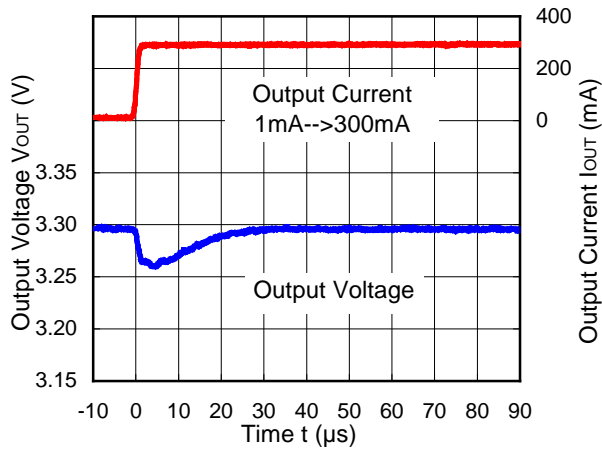

**RP505K331A/B (V<sub>IN</sub>=5.0V)**  
**MODE="H" forced PWM**

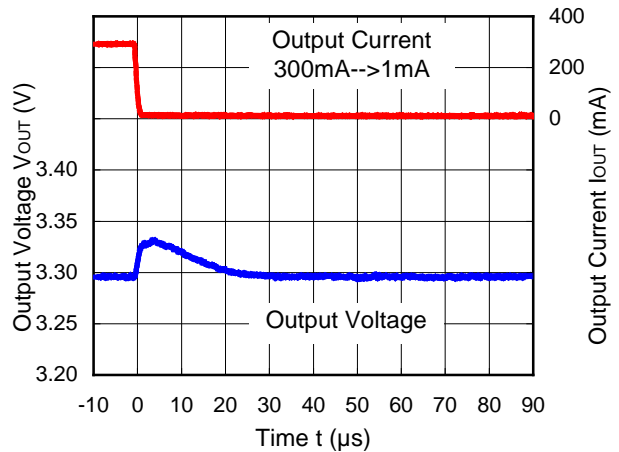

**RP505K331A/B (V<sub>IN</sub>=5.0V)**

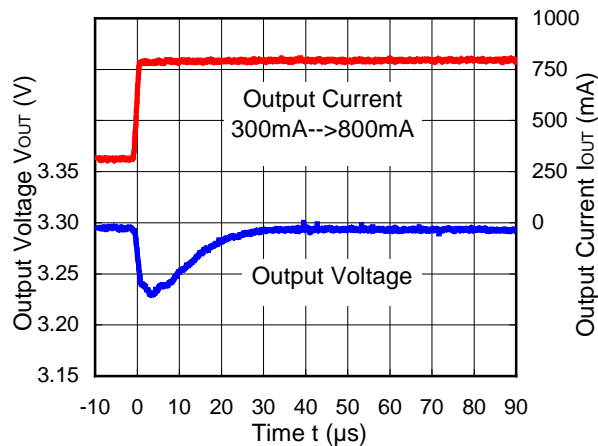

**RP505K331A/B (V<sub>IN</sub>=5.0V)**

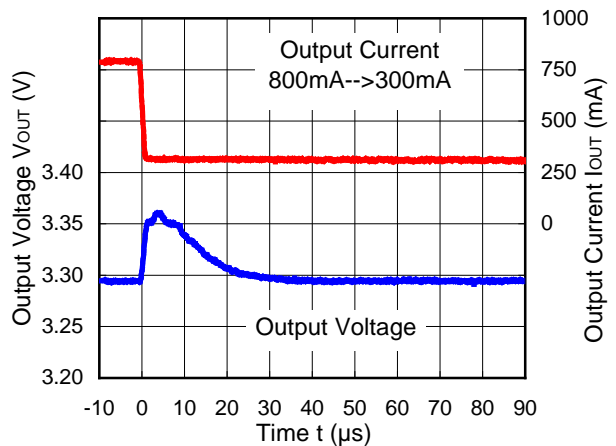

RP505K001C ( $V_{IN}=3.6V$ ,  $V_{OUT}=0.8V$ )  
 MODE="L" PWM/VFM automatic shift

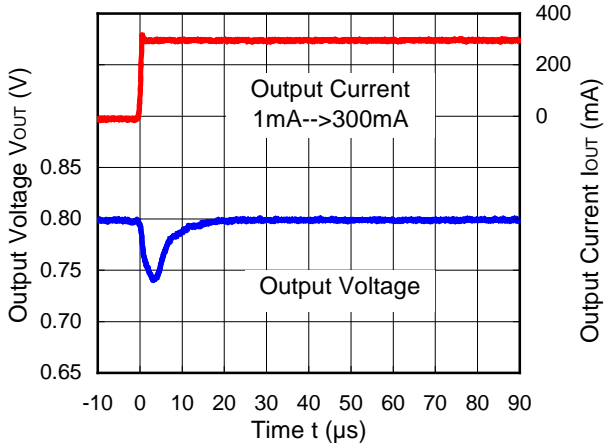

RP505K001C ( $V_{IN}=3.6V$ ,  $V_{OUT}=0.8V$ )  
 MODE="L" PWM/VFM モード自動切替え

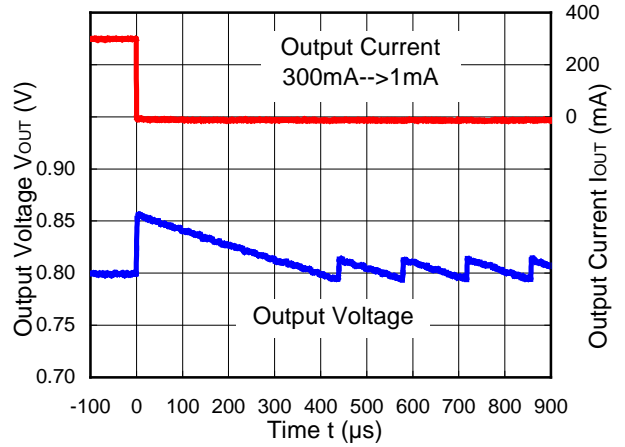

RP505K001C ( $V_{IN}=3.6V$ ,  $V_{OUT}=0.8V$ )  
 MODE="H" forced PWM

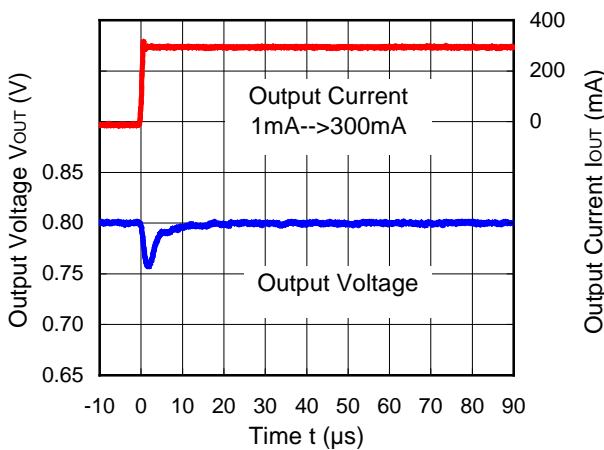

RP505K001C ( $V_{IN}=3.6V$ ,  $V_{OUT}=0.8V$ )  
 MODE="H" forced PWM

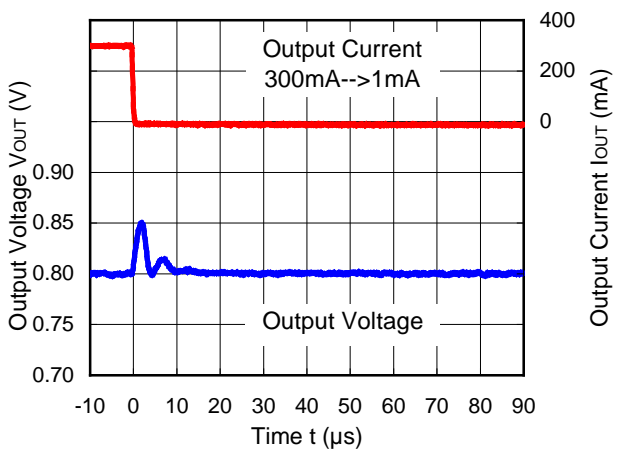

RP505K001C ( $V_{IN}=3.6V$ ,  $V_{OUT}=0.8V$ )

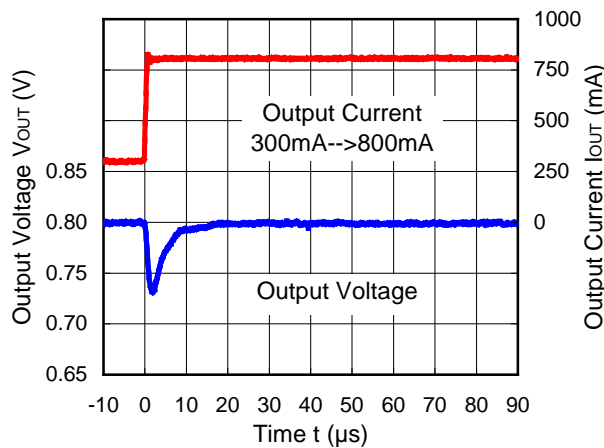

RP505K001C ( $V_{IN}=3.6V$ ,  $V_{OUT}=0.8V$ )

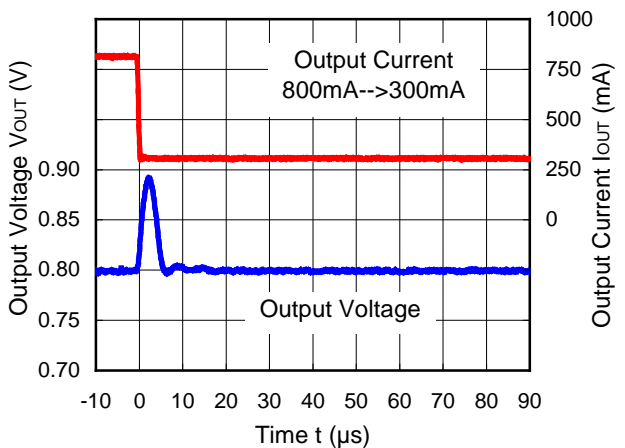

RP505K001C ( $V_{IN}=3.6V$ ,  $V_{OUT}=1.2V$ )  
 MODE="L" PWM/VFM automatic shift

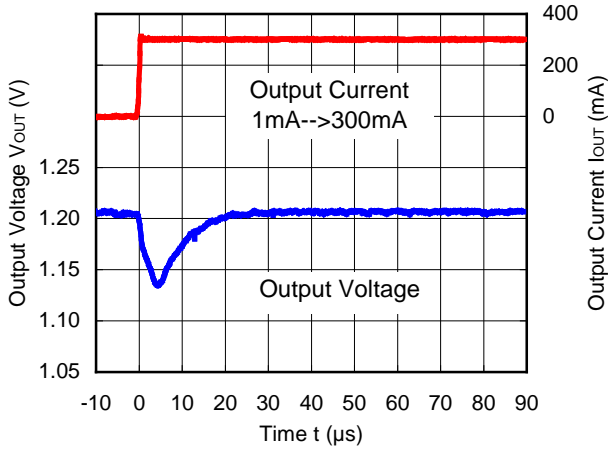

RP505K001C ( $V_{IN}=3.6V$ ,  $V_{OUT}=1.2V$ )  
 MODE="L" PWM/VFM automatic shift

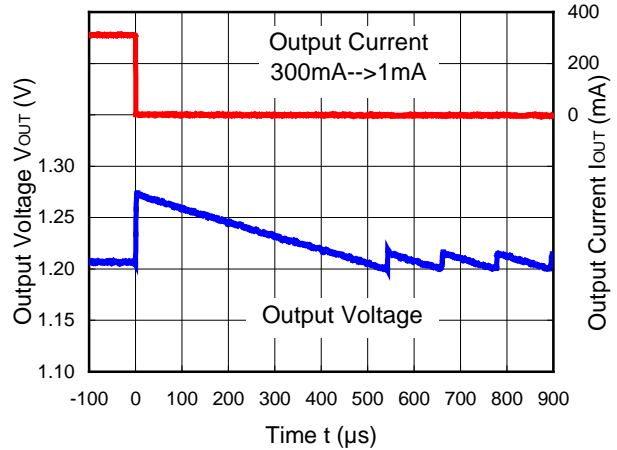

RP505K001C ( $V_{IN}=3.6V$ ,  $V_{OUT}=1.2V$ )  
 MODE="H" forced PWM

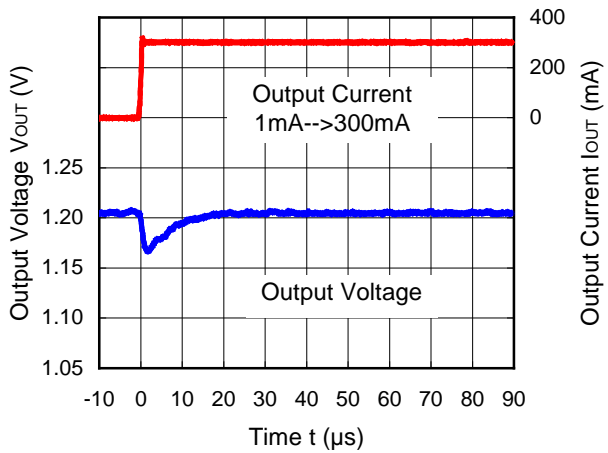

RP505K001C ( $V_{IN}=3.6V$ ,  $V_{OUT}=1.2V$ )  
 MODE="H" forced PWM

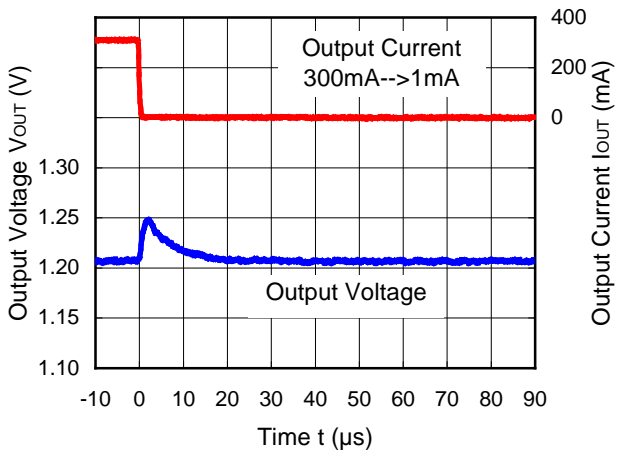

RP505K001C ( $V_{IN}=3.6V$ ,  $V_{OUT}=1.2V$ )

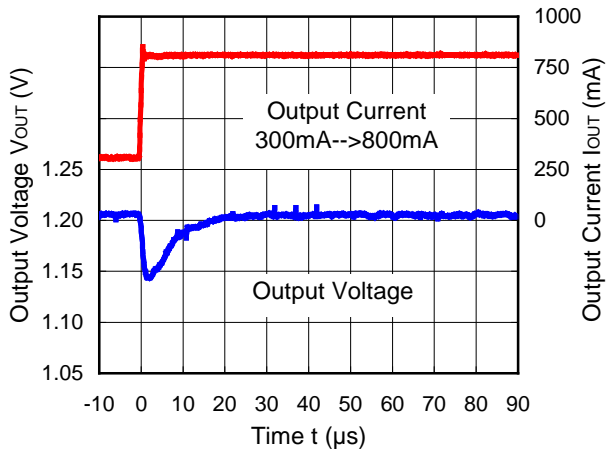

RP505K001C ( $V_{IN}=3.6V$ ,  $V_{OUT}=1.2V$ )

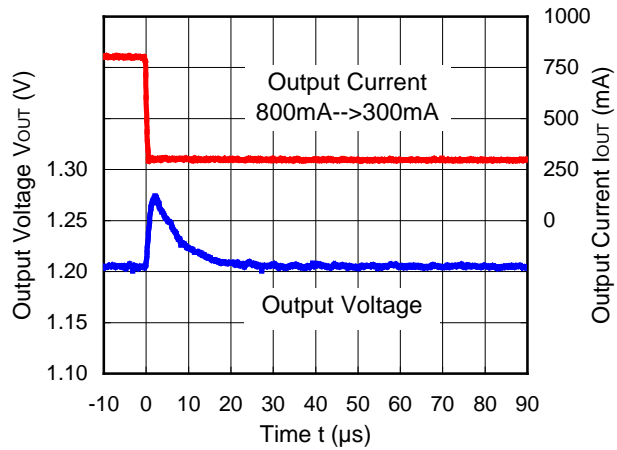

**RP505K001C (V<sub>IN</sub>=3.6V, V<sub>OUT</sub>=1.8V)**  
**MODE="L" PWM/VFM automatic shift**

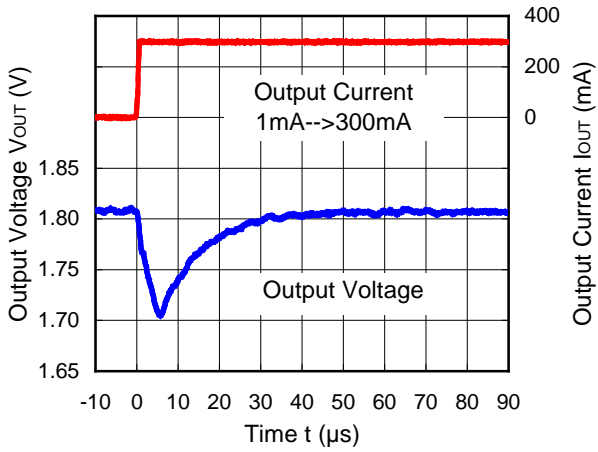

**RP505K001C (V<sub>IN</sub>=3.6V, V<sub>OUT</sub>=1.8V)**  
**MODE="L" PWM/VFM automatic shift**

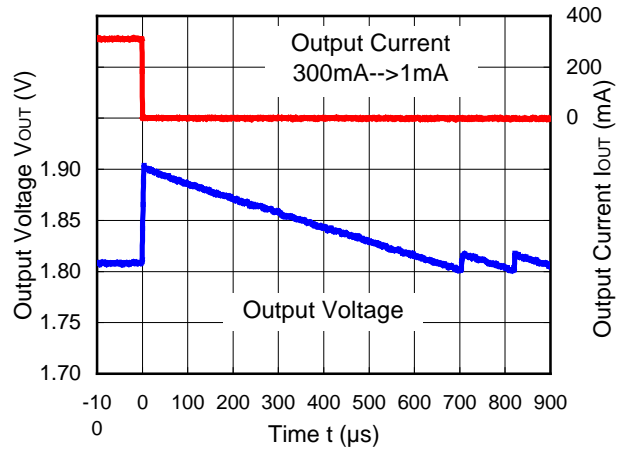

**RP505K001C (V<sub>IN</sub>=3.6V, V<sub>OUT</sub>=1.8V)**  
**MODE="H" forced PWM**

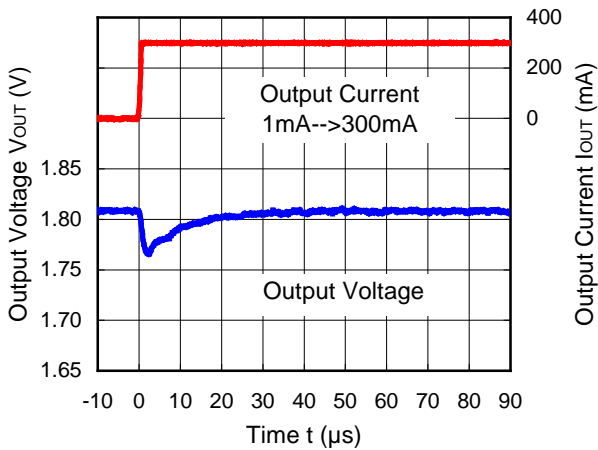

**RP505K001C (V<sub>IN</sub>=3.6V, V<sub>OUT</sub>=1.8V)**  
**MODE="H" forced PWM**

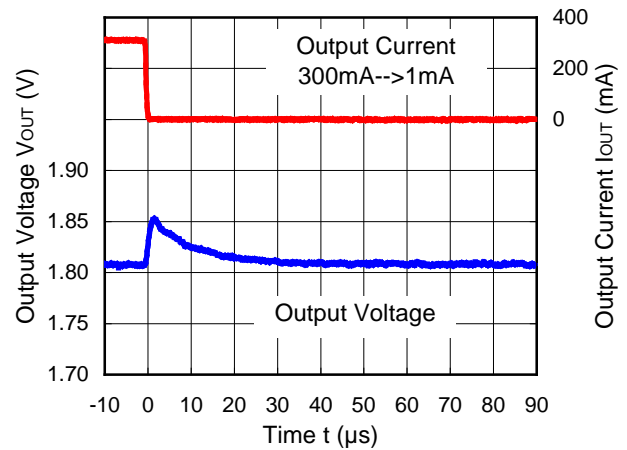

**RP505K001C (V<sub>IN</sub>=3.6V, V<sub>OUT</sub>=1.8V)**

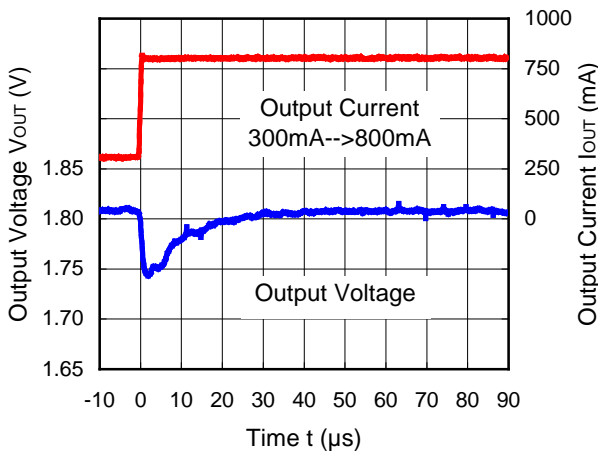

**RP505K001C (V<sub>IN</sub>=3.6V, V<sub>OUT</sub>=1.8V)**

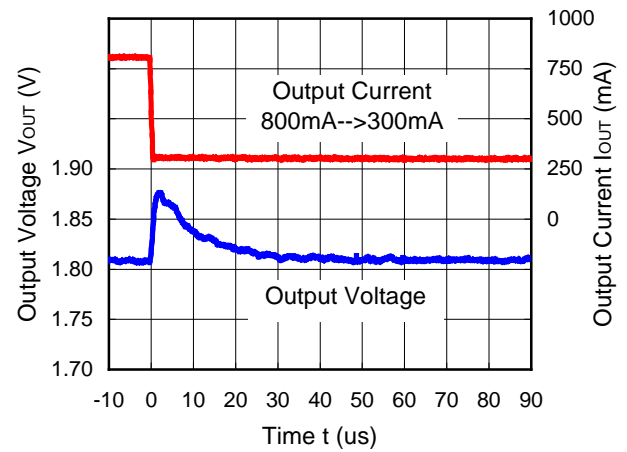

**RP505K001C (V<sub>IN</sub>=5.0V, V<sub>OUT</sub>=3.3V)**  
**MODE="L" PWM/VFM automatic shift**

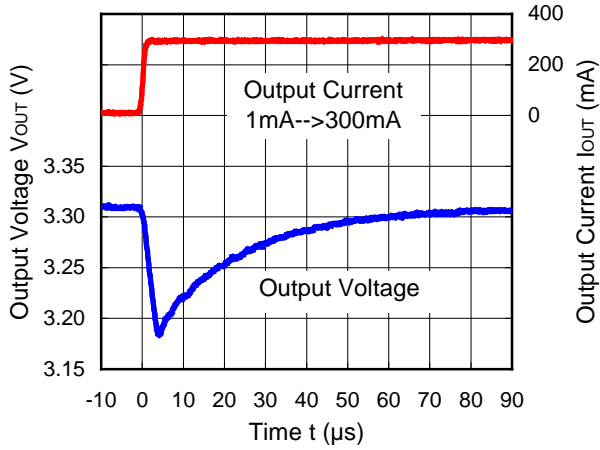

**RP505K001C (V<sub>IN</sub>=5.0V, V<sub>OUT</sub>=3.3V)**  
**MODE="L" PWM/VFM automatic shift**

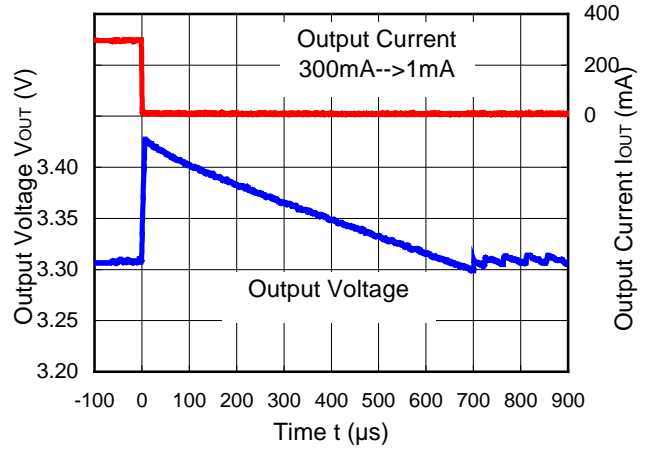

**RP505K001C (V<sub>IN</sub>=5.0V, V<sub>OUT</sub>=3.3V)**  
**MODE="H" forced PWM**

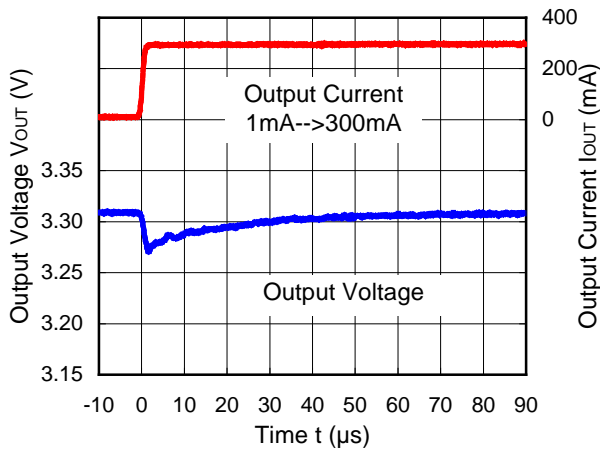

**RP505K001C (V<sub>IN</sub>=5.0V, V<sub>OUT</sub>=3.3V)**  
**MODE="H" forced PWM**

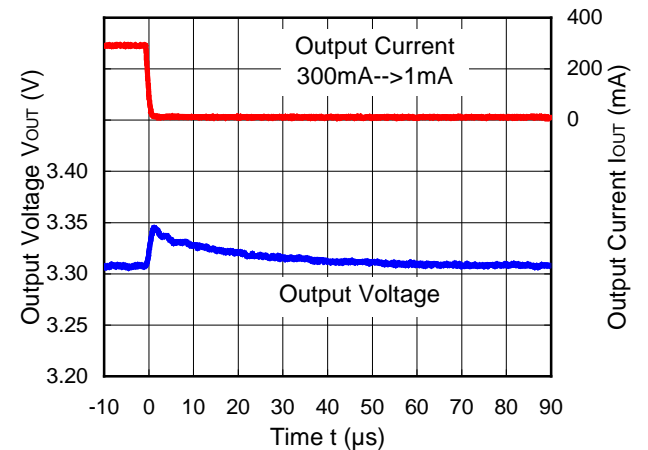

**RP505K001C (V<sub>IN</sub>=5.0V, V<sub>OUT</sub>=3.3V)**

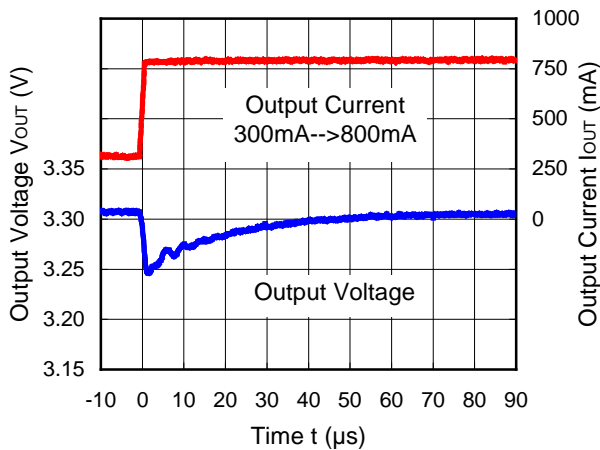

**RP505K001C (V<sub>IN</sub>=5.0V, V<sub>OUT</sub>=3.3V)**

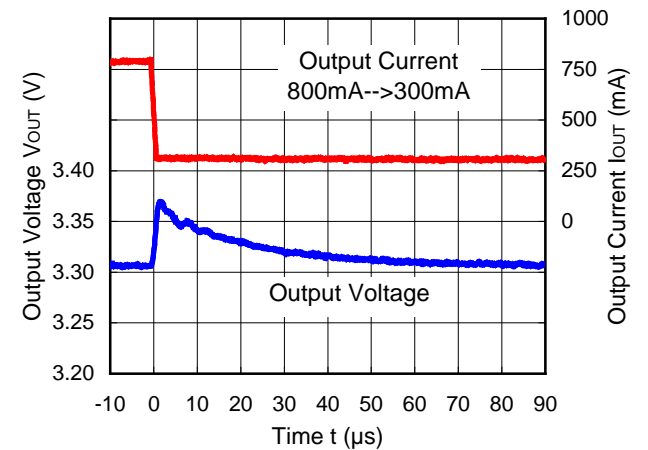

18) Mode Switching Waveform

RP505K181A/B ( $V_{IN}=3.6V$ ,  $I_{OUT}=1mA$ )  
MODE="L" --> MODE="H"

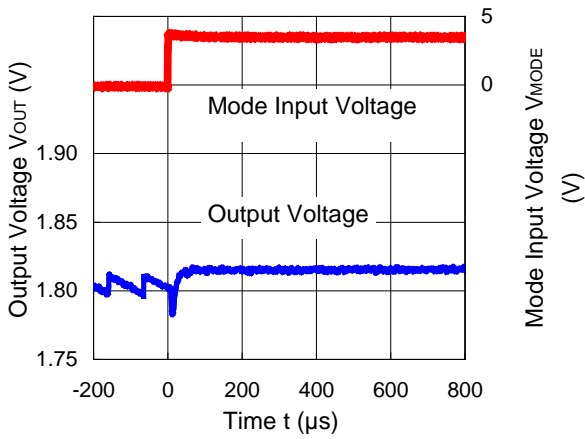

RP505K181A/B ( $V_{IN}=3.6V$ ,  $I_{OUT}=1mA$ )  
MODE="H" --> MODE="L"

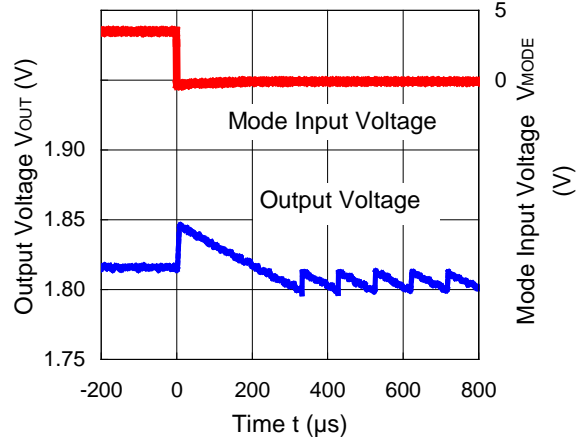

RP505K001C ( $V_{IN}=3.6V$ ,  $V_{OUT}=1.2V$ ,  $I_{OUT}=1mA$ )  
MODE="L" --> MODE="H"

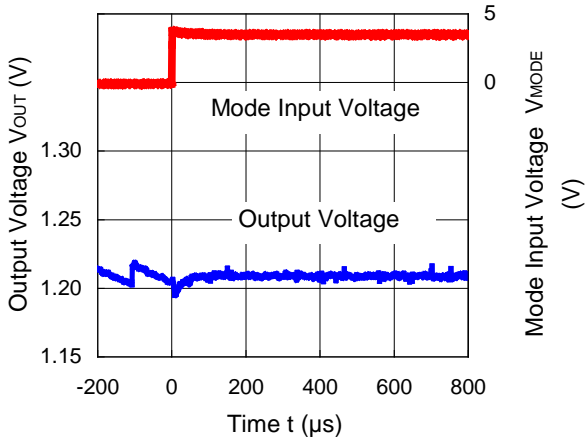

RP505K001C ( $V_{IN}=3.6V$ ,  $V_{OUT}=1.2V$ ,  $I_{OUT}=1mA$ )  
MODE="H" --> MODE="L"

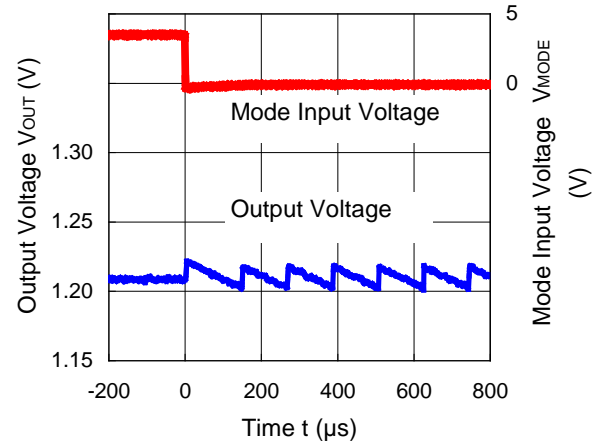

RP505K001C ( $V_{IN}=3.6V$ ,  $V_{OUT}=1.8V$ ,  $I_{OUT}=1mA$ )  
MODE="L" --> MODE="H"

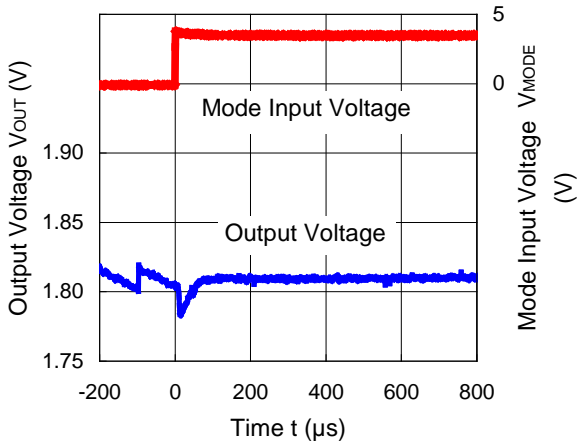

RP505K001C ( $V_{IN}=3.6V$ ,  $V_{OUT}=1.8V$ ,  $I_{OUT}=1mA$ )  
MODE="H" --> MODE="L"

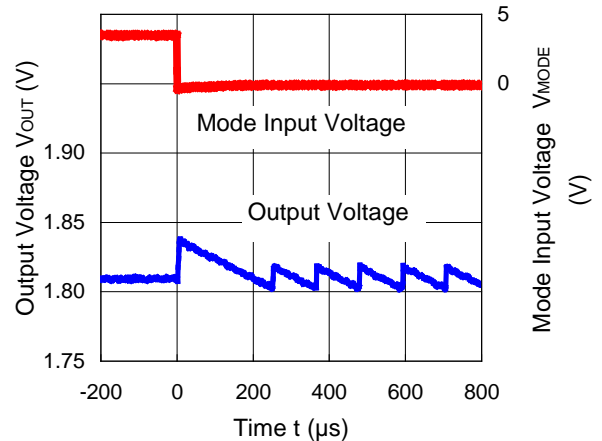



1. The products and the product specifications described in this document are subject to change or discontinuation of production without notice for reasons such as improvement. Therefore, before deciding to use the products, please refer to Ricoh sales representatives for the latest information thereon.
2. The materials in this document may not be copied or otherwise reproduced in whole or in part without prior written consent of Ricoh.
3. Please be sure to take any necessary formalities under relevant laws or regulations before exporting or otherwise taking out of your country the products or the technical information described herein.
4. The technical information described in this document shows typical characteristics of and example application circuits for the products. The release of such information is not to be construed as a warranty of or a grant of license under Ricoh's or any third party's intellectual property rights or any other rights.
5. The products listed in this document are intended and designed for use as general electronic components in standard applications (office equipment, telecommunication equipment, measuring instruments, consumer electronic products, amusement equipment etc.). Those customers intending to use a product in an application requiring extreme quality and reliability, for example, in a highly specific application where the failure or misoperation of the product could result in human injury or death (aircraft, spacevehicle, nuclear reactor control system, traffic control system, automotive and transportation equipment, combustion equipment, safety devices, life support system etc.) should first contact us.
6. We are making our continuous effort to improve the quality and reliability of our products, but semiconductor products are likely to fail with certain probability. In order to prevent any injury to persons or damages to property resulting from such failure, customers should be careful enough to incorporate safety measures in their design, such as redundancy feature, fire containment feature and fail-safe feature. We do not assume any liability or responsibility for any loss or damage arising from misuse or inappropriate use of the products.
7. Anti-radiation design is not implemented in the products described in this document.
8. Please contact Ricoh sales representatives should you have any questions or comments concerning the products or the technical information.



**Ricoh is committed to reducing the environmental loading materials in electrical devices with a view to contributing to the protection of human health and the environment.**

Ricoh has been providing RoHS compliant products since April 1, 2006 and Halogen-free products since April 1, 2012.

**RICOH** RICOH ELECTRONIC DEVICES CO., LTD.

<http://www.e-devices.ricoh.co.jp/en/>

#### Sales & Support Offices

##### **RICOH ELECTRONIC DEVICES CO., LTD.**

**Higashi-Shinagawa Office (International Sales)**  
3-32-3, Higashi-Shinagawa, Shinagawa-ku, Tokyo 140-8655, Japan  
Phone: +81-3-5479-2857 Fax: +81-3-5479-0502

##### **RICOH EUROPE (NETHERLANDS) B.V.**

**Semiconductor Support Centre**  
Prof. W.H. Keesomlaan 1, 1183 DJ Amstelveen, The Netherlands  
Phone: +31-20-5474-309

##### **RICOH ELECTRONIC DEVICES KOREA CO., LTD.**

3F, Haesung Bldg. 504, Teheran-ro, Gangnam-gu, Seoul, 135-725, Korea  
Phone: +82-2-2135-5700 Fax: +82-2-2051-5713

##### **RICOH ELECTRONIC DEVICES SHANGHAI CO., LTD.**

Room 403, No.2 Building, No.690 Bilbo Road, Pu Dong New District, Shanghai 201203,  
People's Republic of China  
Phone: +86-21-5027-3200 Fax: +86-21-5027-3299

##### **RICOH ELECTRONIC DEVICES CO., LTD.**

**Taipei office**  
Room 109, 10F-1, No.51, Hengyang Rd., Taipei City, Taiwan (R.O.C.)  
Phone: +886-2-2313-1621/1622 Fax: +886-2-2313-1623



# Mouser Electronics

Authorized Distributor

Click to View Pricing, Inventory, Delivery & Lifecycle Information:

## Ricoh Electronics:

[RP505K331A-TR](#) [RP505K121B-TR](#) [RP505K001C-TR](#) [RP505K151A-TR](#) [RP505K331B-TR](#) [RP505K101B-TR](#)  
[RP505K301B-TR](#) [RP505K251A-TR](#) [RP505K181B-TR](#) [RP505K121A-TR](#) [RP505K151B-TR](#) [RP505K181A-TR](#)  
[RP505K101A-TR](#)

Компания «Океан Электроники» предлагает заключение долгосрочных отношений при поставках импортных электронных компонентов на взаимовыгодных условиях!

Наши преимущества:

- Поставка оригинальных импортных электронных компонентов напрямую с производств Америки, Европы и Азии, а так же с крупнейших складов мира;
- Широкая линейка поставок активных и пассивных импортных электронных компонентов (более 30 млн. наименований);
- Поставка сложных, дефицитных, либо снятых с производства позиций;
- Оперативные сроки поставки под заказ (от 5 рабочих дней);
- Экспресс доставка в любую точку России;
- Помощь Конструкторского Отдела и консультации квалифицированных инженеров;
- Техническая поддержка проекта, помощь в подборе аналогов, поставка прототипов;
- Поставка электронных компонентов под контролем ВП;
- Система менеджмента качества сертифицирована по Международному стандарту ISO 9001;
- При необходимости вся продукция военного и аэрокосмического назначения проходит испытания и сертификацию в лаборатории (по согласованию с заказчиком);
- Поставка специализированных компонентов военного и аэрокосмического уровня качества (Xilinx, Altera, Analog Devices, Intersil, Interpoint, Microsemi, Actel, Aeroflex, Peregrine, VPT, Syfer, Eurofarad, Texas Instruments, MS Kennedy, Miteq, Cobham, E2V, MA-COM, Hittite, Mini-Circuits, General Dynamics и др.);

Компания «Океан Электроники» является официальным дистрибьютором и эксклюзивным представителем в России одного из крупнейших производителей разъемов военного и аэрокосмического назначения «JONHON», а так же официальным дистрибьютором и эксклюзивным представителем в России производителя высокотехнологичных и надежных решений для передачи СВЧ сигналов «FORSTAR».



## JONHON

«JONHON» (основан в 1970 г.)

Разъемы специального, военного и аэрокосмического назначения:

(Применяются в военной, авиационной, аэрокосмической, морской, железнодорожной, горно- и нефтедобывающей отраслях промышленности)

«FORSTAR» (основан в 1998 г.)

ВЧ соединители, коаксиальные кабели, кабельные сборки и микроволновые компоненты:

(Применяются в телекоммуникациях гражданского и специального назначения, в средствах связи, РЛС, а так же военной, авиационной и аэрокосмической отраслях промышленности).



Телефон: 8 (812) 309-75-97 (многоканальный)

Факс: 8 (812) 320-03-32

Электронная почта: [ocean@oceanchips.ru](mailto:ocean@oceanchips.ru)

Web: <http://oceanchips.ru/>

Адрес: 198099, г. Санкт-Петербург, ул. Калинина, д. 2, корп. 4, лит. А