

Round Through-Hole LED Lamp (3 mm)



OVLBx4C7 Series

Features:

- High brightness with well-defined spatial radiation patterns
- UV-resistant epoxy lens
- Lead-frame material is iron alloy with tin plated leads
- No stand-offs



Description:

Each OVLBx4C7 series device is a high-intensity LED mounted in a clear plastic T-1 package. The LED provides a well-defined and even emission pattern. Its UV-resistant epoxy lens makes this device an optimal solution for outdoor applications.

Applications:

- Pedestrian signals
- Signage and architectural lighting
- Backlighting
- Automotive
- Outdoor/indoor displays

Part Number	Material	Emitted Color	Intensity Typ. mcd	Lens Color
OVLBB4C7	InGaN	Blue	1800	Clear
OVLBG4C7		Green	8400	Clear
OVLBR4C7	AlInGaP	Red	3700	Clear
OVLBY4C7		Yellow	3700	Clear

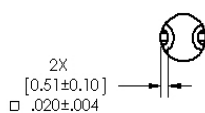
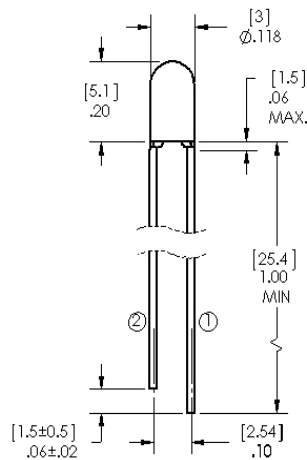

General tolerance +/- .25mm unless

- ① ANODE
- ② CATHODE

Dimensions are in Inches [MM]

DO NOT LOOK DIRECTLY AT LED WITH UNSHIELDED EYES OR DAMAGE TO RETINA MAY

General Note

TT Electronics reserves the right to make changes in product specification without notice or liability. All information is subject to TT Electronics' own data and is considered accurate at time of going to print.

TT Electronics | Optek Technology, Inc.
1645 Wallace Drive, Ste. 130, Carrollton, TX USA 75006 | Ph: +1 972 323 2200
www.ttelectronics.com | sensors@ttelectronics.com

Electrical Specifications

Absolute Maximum Ratings ($T_A = 25^\circ\text{C}$ unless otherwise noted)

Storage Temperature Range		-40 ~ +100 °C
Operating Temperature Range		-40 ~ +100 °C
Reverse Voltage (Device not designed for reverse voltage applications)		5 V Max
Continuous Forward Current (Design of heat dissipation should be considered)	Blue, Green	25 mA
Continuous Forward Current (Design of heat dissipation should be considered)	Red, Yellow	50 mA
Peak Forward Current (10% Duty Cycle, 1 kHz)	Blue, Green	100 mA
Peak Forward Current (10% Duty Cycle, 1 kHz)	Red, Yellow	100 mA
Power Dissipation	Blue, Green	100 mW
Power Dissipation	Red, Yellow	120 mW
Current Linearity vs Ambient Temperature	Blue, Green	-0.29 mA/°C
Current Linearity vs Ambient Temperature	Red, Yellow	-0.72 mA/°C
LED Junction Temperature		125° C
Electrostatic Discharge Classification (JEDEC-JESD22-A114F)		Class 1C
Lead Soldering Temperature (4 mm away from the base of the epoxy bulb)		260° C / 3 seconds

Electrical Characteristics ($T_A = 25^\circ\text{C}$ unless otherwise noted)

SYMBOL	PARAMETER	COLOR	MIN	TYP	MAX	UNITS	CONDITIONS
I_V	Luminous Intensity	Blue	1135	1800	----	mcd	$I_F = 20\text{ mA}$
		Green	4360	8400	----		
		Red	2225	3700	----		
		Yellow	2225	3700	----		
V_F	Forward Voltage	Blue	2.6	3.2	4.0	V	$I_F = 20\text{ mA}$
		Green					
		Red	1.8	2.0	2.4		
		Yellow					
I_R	Reverse Current	Blue	----	----	10	μA	$V_R = 5\text{ V}$
		Green	----	----			
		Red	----	----			
		Yellow	----	----			
λ_D	Dominant Wavelength	Blue	460	470	475	nm	$I_F = 20\text{ mA}$
		Green	519	525	531		
		Red	620	623	630		
		Yellow	585	589	595		
2 $\theta_{\frac{1}{2}}$ H-H	50% Power Angle		----	45	----	deg	$I_F = 20\text{ mA}$

General Note

TT Electronics reserves the right to make changes in product specification without notice or liability. All information is subject to TT Electronics' own data and is considered accurate at time of going to print.

TT Electronics | Optek Technology, Inc.
1645 Wallace Drive, Ste. 130, Carrollton, TX USA 75006 | Ph: +1 972 323 2200
www.ttelectronics.com | sensors@ttelectronics.com

Typical Electro-Optical Characteristics Curves (BLUE)

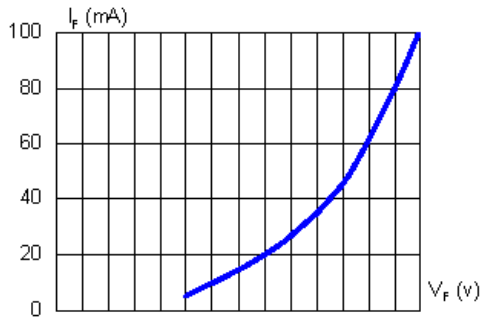

Fig.1 Forward Current vs. Forward Voltage

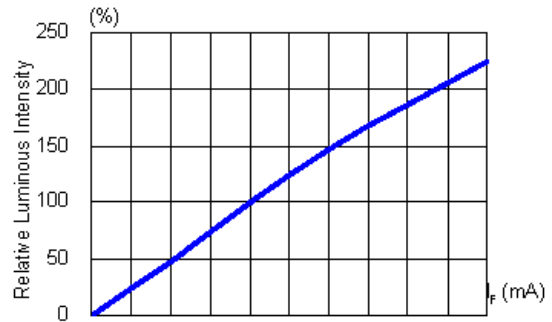

Fig.2 Luminous Intensity vs. Forward Current

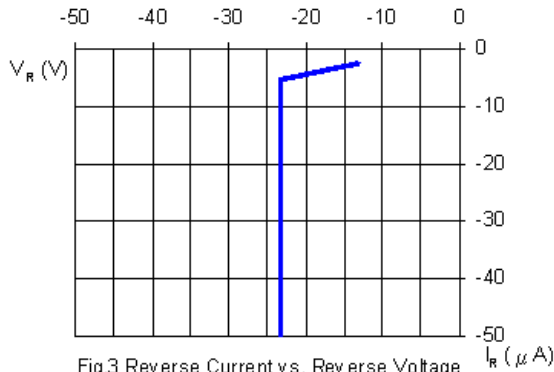

Fig.3 Reverse Current vs. Reverse Voltage

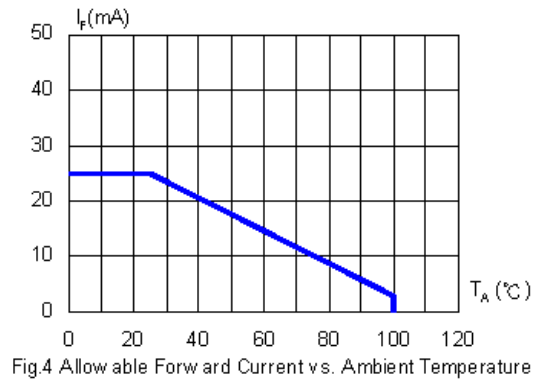

Fig.4 Allowable Forward Current vs. Ambient Temperature

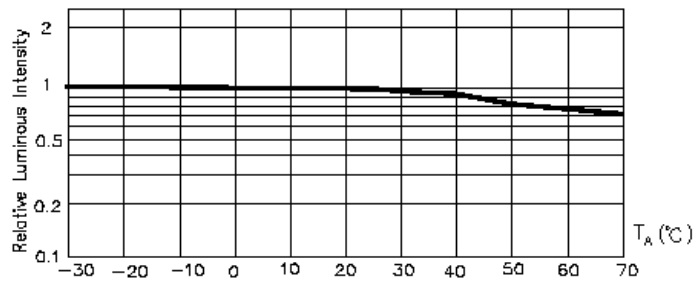

Fig.5 Luminous Intensity at $I_F=20mA$ vs. Ambient Temperature

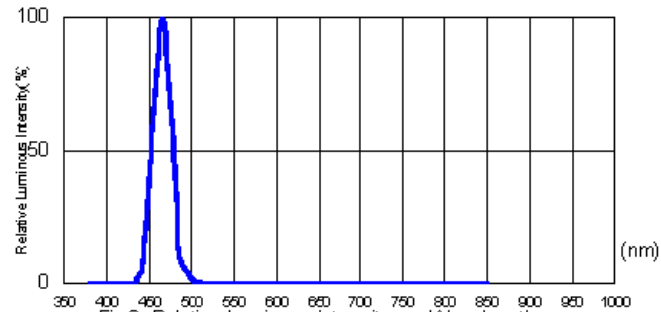

Fig.6. Relative Luminous Intensity vs. Wavelength

General Note

TT Electronics reserves the right to make changes in product specification without notice or liability. All information is subject to TT Electronics' own data and is considered accurate at time of going to print.

TT Electronics | Optek Technology, Inc.
1645 Wallace Drive, Ste. 130, Carrollton, TX USA 75006 | Ph: +1 972 323 2200
www.ttelectronics.com | sensors@ttelectronics.com

Typical Electro-Optical Characteristics Curves (GREEN)

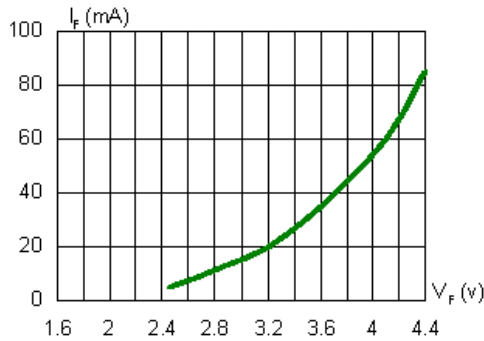

Fig.1 Forward Current vs. Forward Voltage

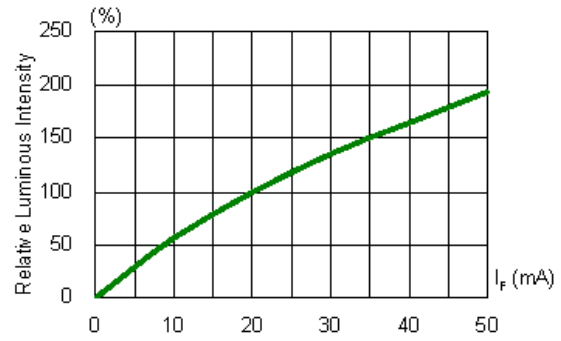

Fig.2 Luminous Intensity vs. Forward Current

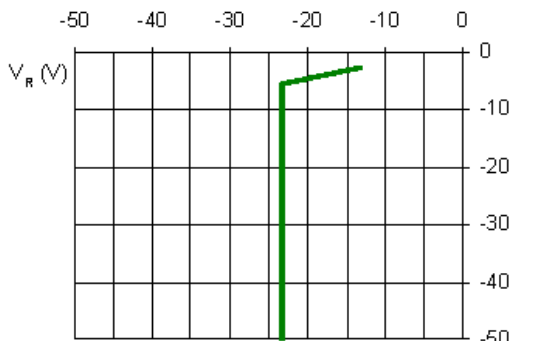

Fig.3 Reverse Current vs. Reverse Voltage

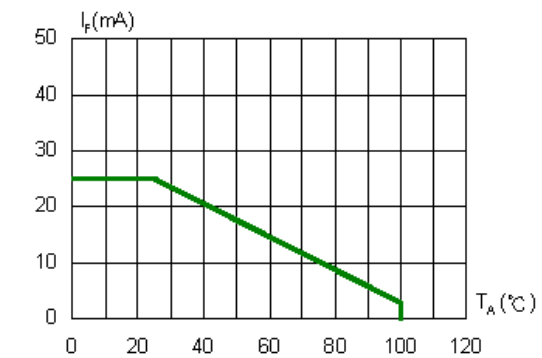

Fig.4 Allowable Forward Current vs. Ambient Temperature

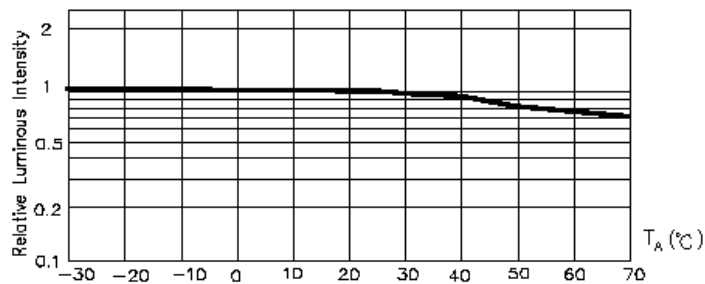

Fig.5 Luminous Intensity at $I_F = 20mA$ vs. Ambient Temperature

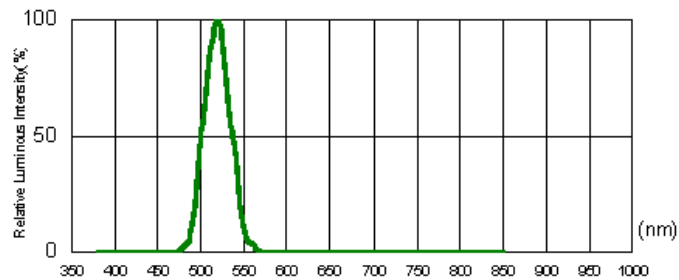

Fig.6. Relative Luminous Intensity vs. Wavelength

General Note

TT Electronics reserves the right to make changes in product specification without notice or liability. All information is subject to TT Electronics' own data and is considered accurate at time of going to print.

TT Electronics | Optek Technology, Inc.
1645 Wallace Drive, Ste. 130, Carrollton, TX USA 75006 | Ph: +1 972 323 2200
www.ttelectronics.com | sensors@ttelectronics.com

Typical Electro-Optical Characteristics Curves (RED)

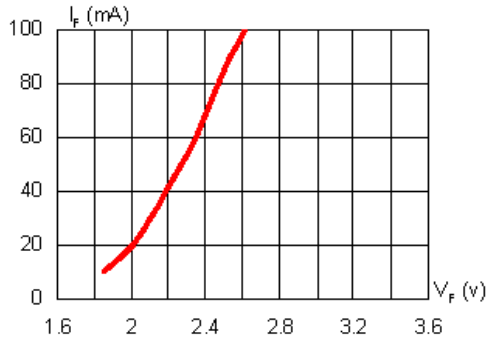

Fig.1 Forward Current vs. Forward Voltage

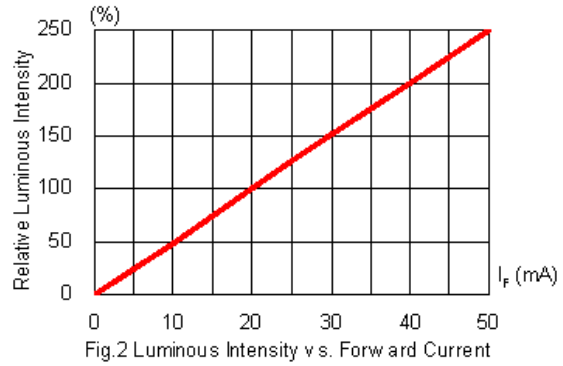

Fig.2 Luminous Intensity vs. Forward Current

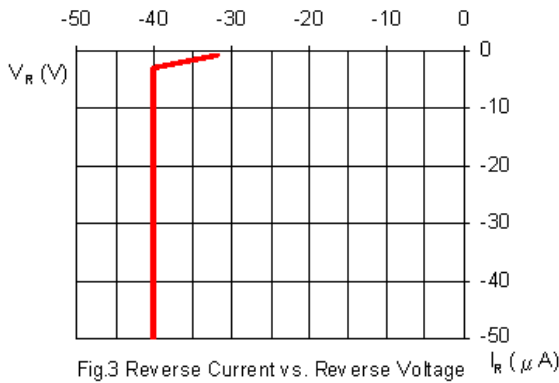

Fig.3 Reverse Current vs. Reverse Voltage

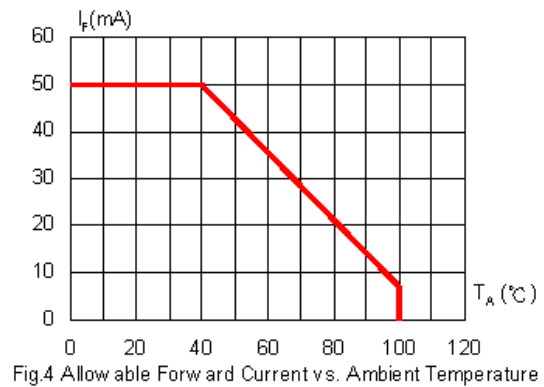

Fig.4 Allowable Forward Current vs. Ambient Temperature

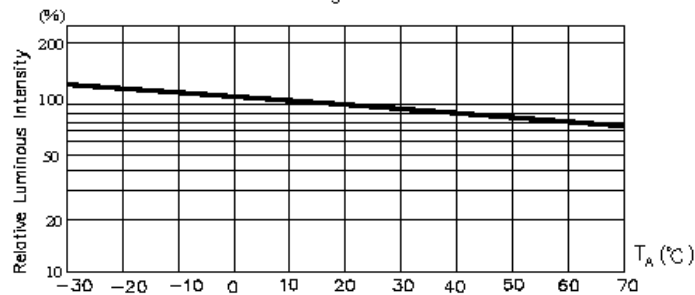

Fig.5 Luminous Intensity at $I_f = 20mA$ vs. Ambient Temperature

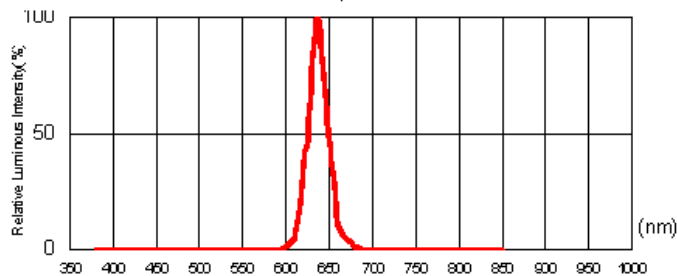

Fig.6. Relative Luminous Intensity vs. Wavelength

General Note

TT Electronics reserves the right to make changes in product specification without notice or liability. All information is subject to TT Electronics' own data and is considered accurate at time of going to print.

TT Electronics | Optek Technology, Inc.
1645 Wallace Drive, Ste. 130, Carrollton, TX USA 75006 | Ph: +1 972 323 2200
www.ttelectronics.com | sensors@ttelectronics.com

Typical Electro-Optical Characteristics Curves (YELLOW)

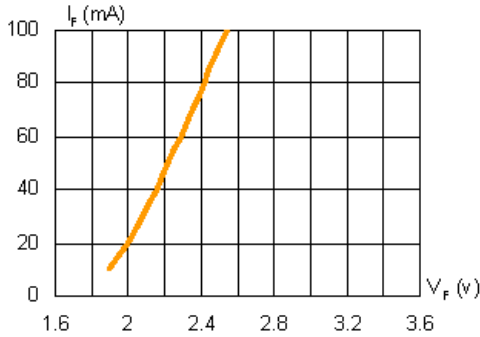

Fig.1 Forward Current vs. Forward Voltage

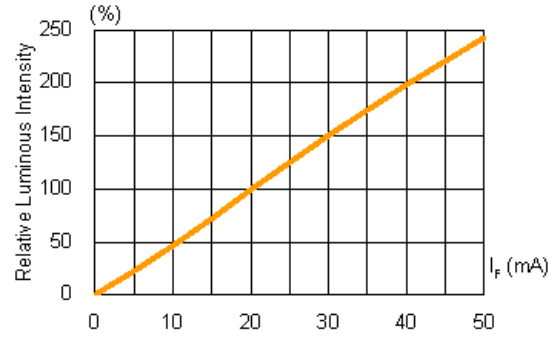

Fig.2 Luminous Intensity vs. Forward Current

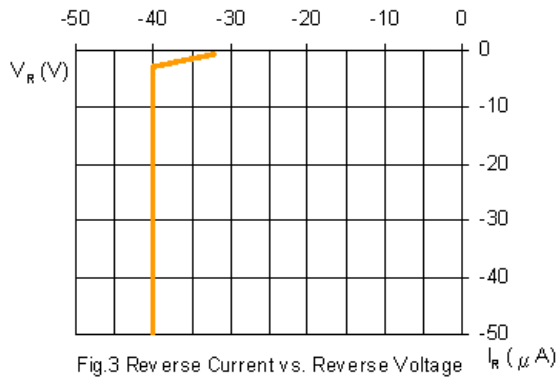

Fig.3 Reverse Current vs. Reverse Voltage

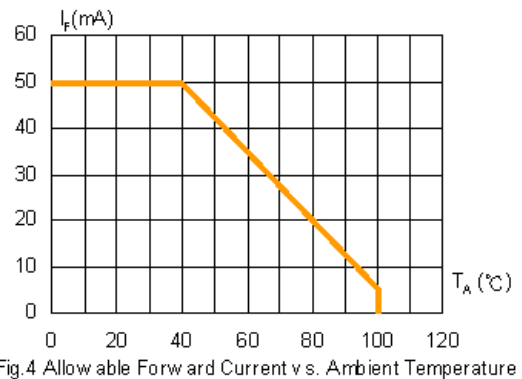

Fig.4 Allowable Forward Current vs. Ambient Temperature

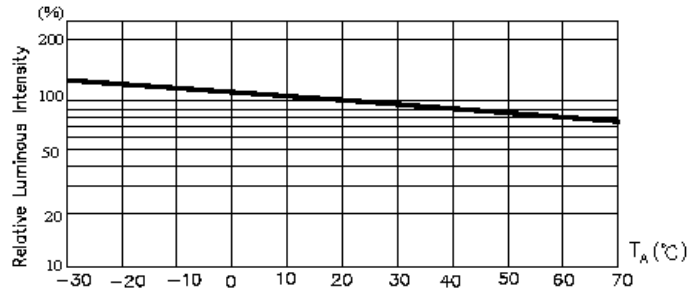

Fig.5 Luminous Intensity at $I_f=20mA$ vs. Ambient Temperature

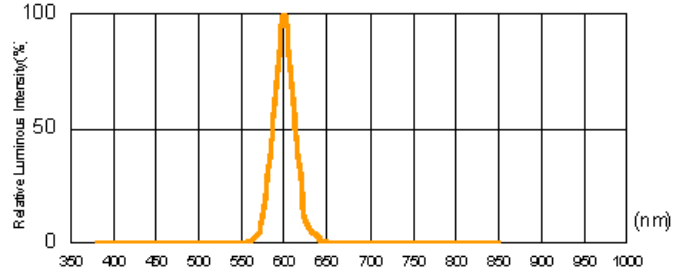

Fig.6. Relative Luminous Intensity vs. Wavelength

General Note

TT Electronics reserves the right to make changes in product specification without notice or liability. All information is subject to TT Electronics' own data and is considered accurate at time of going to print.

TT Electronics | Optek Technology, Inc.
1645 Wallace Drive, Ste. 130, Carrollton, TX USA 75006 | Ph: +1 972 323 2200
www.ttelectronics.com | sensors@ttelectronics.com

Round Through-Hole LED Lamp (3 mm)

OVLBx4C7 Series



Beam Pattern:

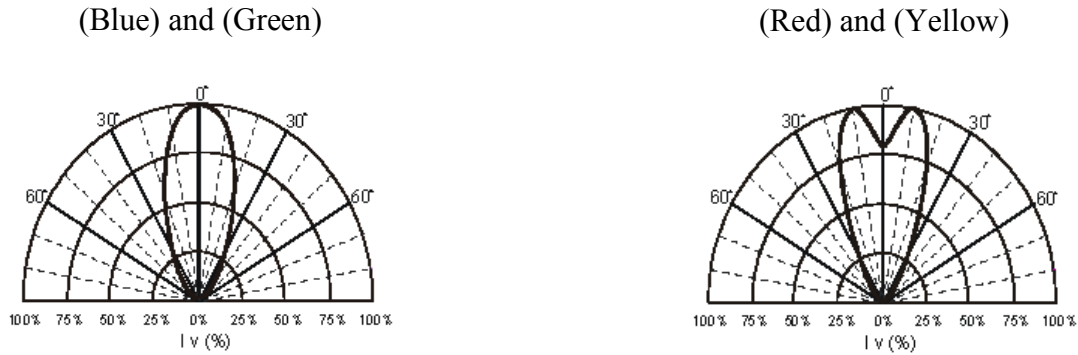

Packaging: 500 pcs per bulk bag with desiccant

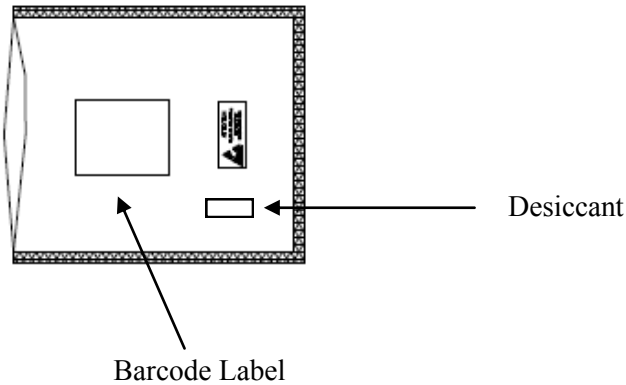

Reliability Test

Classification	Test Item	Standard Test Method	Test Conditions	Duration	Unit	Acc / Rej Criteria	Result
Life Test	Operation Life Test (OLT)	MIL-STD-750D Method 1026.3	$T_A=25^{\circ}\text{C}$, $I_F=30\text{mA}$ *	1000 Hrs	100	0 / 1	Pass
Environment Test	High Temperature Storage (HTS)	MIL-STD-750D Method 1032.1	$T_A=100^{\circ}\text{C}$	1000 Hrs	100	0 / 1	Pass
	Low Temperature Storage (LTS)	MIL-STD-750D Method 1032.1	$T_A=-40^{\circ}\text{C}$	1000 Hrs	100	0 / 1	Pass
	Temp. & Humidity with Bias (THB)	MIL-STD-750D Method 103B	$T_A=85^{\circ}\text{C}$, $\text{Rh}=85\%$ $I_F=20\text{mA}$ **	500 Hrs	100	0 / 1	Pass
	Thermal Shock Test (TST)	MIL-STD-750D Method 1056.1	$0^{\circ}\text{C} \sim 100^{\circ}\text{C}$ 2min 2min	100 cycles	100	0 / 1	Pass
	Temperature Cycling Test (TCT)	MIL-STD-750D Method 1051.5	$-40^{\circ}\text{C} \sim 25^{\circ}\text{C} \sim 100^{\circ}\text{C} \sim 25^{\circ}\text{C}$ 30min 5min 30min 5min	100 cycles	100	0 / 1	Pass
Mechanical Test	Solderability	MIL-STD-750D Method 2026.4	$235\pm 5^{\circ}\text{C}$, 5 sec	1 time	20	0 / 1	Pass
	Resistance to Soldering Heat	MIL-STD-750D Method 2031.1	$260\pm 5^{\circ}\text{C}$, 10 sec	1 time	20	0 / 1	Pass
	Lead Integrity	MIL-STD-750D Method 2036.3	Load 2.5N (0.25kgf) $0^{\circ} \sim 90^{\circ} \sim 0^{\circ}$, bend	3 times	20	0 / 1	Pass

Remark : (*) $I_F=30\text{mA}$ for AlInGaP chip ; $I_F=20\text{mA}$ for InGaN chip

(**) $I_F=20\text{mA}$ for AlInGaP chip ; $I_F=10\text{mA}$ for InGaN chip

2. Failure Criteria ($T_A=25^{\circ}\text{C}$):

Test Item	Symbol	Test Conditions	Criteria for Judgment	
			Min.	Max.
Luminous Intensity	I_V	$I_F=20\text{mA}$	$\text{LSL}\times 0.7$ **	
Voltage (Forward)	V_F	$I_F=20\text{mA}$		$\text{USL}\times 1.1$ *

(*) USL : Upper Standard Level , (**) LSL : Lower Standard Level

General Note

TT Electronics reserves the right to make changes in product specification without notice or liability. All information is subject to TT Electronics' own data and is considered accurate at time of going to print.

TT Electronics | Optek Technology, Inc.
1645 Wallace Drive, Ste. 130, Carrollton, TX USA 75006 | Ph: +1 972 323 2200
www.ttelectronics.com | sensors@ttelectronics.com

Компания «Океан Электроники» предлагает заключение долгосрочных отношений при поставках импортных электронных компонентов на взаимовыгодных условиях!

Наши преимущества:

- Поставка оригинальных импортных электронных компонентов напрямую с производств Америки, Европы и Азии, а так же с крупнейших складов мира;
- Широкая линейка поставок активных и пассивных импортных электронных компонентов (более 30 млн. наименований);
- Поставка сложных, дефицитных, либо снятых с производства позиций;
- Оперативные сроки поставки под заказ (от 5 рабочих дней);
- Экспресс доставка в любую точку России;
- Помощь Конструкторского Отдела и консультации квалифицированных инженеров;
- Техническая поддержка проекта, помощь в подборе аналогов, поставка прототипов;
- Поставка электронных компонентов под контролем ВП;
- Система менеджмента качества сертифицирована по Международному стандарту ISO 9001;
- При необходимости вся продукция военного и аэрокосмического назначения проходит испытания и сертификацию в лаборатории (по согласованию с заказчиком);
- Поставка специализированных компонентов военного и аэрокосмического уровня качества (Xilinx, Altera, Analog Devices, Intersil, Interpoint, Microsemi, Actel, Aeroflex, Peregrine, VPT, Syfer, Eurofarad, Texas Instruments, MS Kennedy, Miteq, Cobham, E2V, MA-COM, Hittite, Mini-Circuits, General Dynamics и др.);

Компания «Океан Электроники» является официальным дистрибьютором и эксклюзивным представителем в России одного из крупнейших производителей разъемов военного и аэрокосмического назначения «JONHON», а так же официальным дистрибьютором и эксклюзивным представителем в России производителя высокотехнологичных и надежных решений для передачи СВЧ сигналов «FORSTAR».



JONHON

«JONHON» (основан в 1970 г.)

Разъемы специального, военного и аэрокосмического назначения:

(Применяются в военной, авиационной, аэрокосмической, морской, железнодорожной, горно- и нефтедобывающей отраслях промышленности)

«FORSTAR» (основан в 1998 г.)

ВЧ соединители, коаксиальные кабели, кабельные сборки и микроволновые компоненты:

(Применяются в телекоммуникациях гражданского и специального назначения, в средствах связи, РЛС, а так же военной, авиационной и аэрокосмической отраслях промышленности).



Телефон: 8 (812) 309-75-97 (многоканальный)

Факс: 8 (812) 320-03-32

Электронная почта: ocean@oceanchips.ru

Web: <http://oceanchips.ru/>

Адрес: 198099, г. Санкт-Петербург, ул. Калинина, д. 2, корп. 4, лит. А