



### FEATURES

Ultralow power, high performance transceiver

Frequency bands

862 MHz to 928 MHz

431 MHz to 464 MHz

Data rates supported

1 kbps to 300 kbps

2.2 V to 3.6 V power supply

Single-ended and differential PAs

Low IF receiver with programmable IF bandwidths

100 kHz, 150 kHz, 200 kHz, 300 kHz

Receiver sensitivity (BER)

-116 dBm at 1.0 kbps, 2FSK, GFSK

-107.5 dBm at 38.4 kbps, 2FSK, GFSK

-102.5 dBm at 150 kbps, GFSK, GMSK

-100 dBm at 300 kbps, GFSK, GMSK

-104 dBm at 19.2 kbps, OOK

Very low power consumption

12.8 mA in PHY\_RX mode (maximum front-end gain)

24.1 mA in PHY\_TX mode (10 dBm output, single-ended PA)

0.75  $\mu$ A in PHY\_SLEEP mode (32 kHz RC oscillator active)

1.28  $\mu$ A in PHY\_SLEEP mode (32 kHz XTAL oscillator active)

0.33  $\mu$ A in PHY\_SLEEP mode (Deep Sleep Mode 1)

RF output power of -20 dBm to +13.5 dBm (single-ended PA)

RF output power of -20 dBm to +10 dBm (differential PA)

Patented fast settling automatic frequency control (AFC)

Digital received signal strength indication (RSSI)

Integrated PLL loop filter and Tx/Rx switch

Fast automatic VCO calibration

Automatic synthesizer bandwidth optimization

On-chip, low-power, custom 8-bit processor

Radio control

Packet management

Smart wake mode

Packet management support

Highly flexible for a wide range of packet formats

Insertion/detection of preamble/sync word/CRC/address

Manchester and 8b/10b data encoding and decoding

Data whitening

Smart wake mode

Current saving low power mode with autonomous receiver wake up, carrier sense, and packet reception

Downloadable firmware modules

Image rejection calibration, fully automated (patent pending)

128-bit AES encryption/decryption with hardware acceleration and key sizes of 128 bits, 192 bits, and 256 bits

Reed Solomon error correction with hardware acceleration

240-byte packet buffer for TX/RX data

Efficient SPI control interface with block read/write access

Integrated battery alarm and temperature sensor

Integrated RC and 32.768 kHz crystal oscillator

On-chip, 8-bit ADC

5 mm  $\times$  5 mm, 32-pin, LFCSP package

### APPLICATIONS

Smart metering

IEEE 802.15.4g

Wireless MBUS

Home automation

Process and building control

Wireless sensor networks (WSNs)

Wireless healthcare

Rev. C

Information furnished by Analog Devices is believed to be accurate and reliable. However, no responsibility is assumed by Analog Devices for its use, nor for any infringements of patents or other rights of third parties that may result from its use. Specifications subject to change without notice. No license is granted by implication or otherwise under any patent or patent rights of Analog Devices. Trademarks and registered trademarks are the property of their respective owners.

One Technology Way, P.O. Box 9106, Norwood, MA 02062-9106, U.S.A.

Tel: 781.329.4700

[www.analog.com](http://www.analog.com)

Fax: 781.461.3113

©2010–2012 Analog Devices, Inc. All rights reserved.

## TABLE OF CONTENTS

Features .....	1	Interrupts in Sport Mode .....	53
Applications .....	1	ADF7023 Memory Map .....	54
Revision History .....	3	BBRAM .....	54
Functional Block Diagram .....	4	Modem Configuration RAM (MCR) .....	54
General Description .....	4	Program ROM .....	54
Specifications .....	6	Program RAM .....	54
RF and Synthesizer Specifications .....	6	Packet RAM .....	55
Transmitter Specifications .....	7	SPI Interface .....	56
Receiver Specifications .....	9	General Characteristics .....	56
Timing and Digital Specifications .....	13	Command Access .....	56
Auxiliary Block Specifications .....	14	Status Word .....	56
General Specifications .....	15	Command Queuing .....	57
Timing Specifications .....	16	Memory Access .....	58
Absolute Maximum Ratings .....	17	Low Power Modes .....	61
ESD Caution .....	17	Example Low Power Modes .....	64
Pin Configuration and Function Descriptions .....	18	Low Power Mode Timing Diagrams .....	66
Typical Performance Characteristics .....	20	WUC Setup .....	67
Terminology .....	32	Firmware Timer Setup .....	69
Radio Control .....	33	Calibrating the RC Oscillator .....	69
Radio States .....	33	Downloadable Firmware Modules .....	71
Initialization .....	35	Writing a Module to Program RAM .....	71
Commands .....	35	Image Rejection Calibration Module .....	71
Automatic State Transitions .....	37	Reed Solomon Coding Module .....	71
State Transition and Command Timing .....	38	AES Encryption and Decryption Module .....	71
Packet Mode .....	43	Radio Blocks .....	73
Preamble .....	43	Frequency Synthesizer .....	73
Sync Word .....	44	Crystal Oscillator .....	74
Payload .....	45	Modulation .....	74
CRC .....	46	RF Output Stage .....	74
Postamble .....	47	PA/LNA Interface .....	75
Transmit Packet Timing .....	47	Receive Channel Filter .....	75
Data Whitening .....	48	Image Channel Rejection .....	75
Manchester Encoding .....	48	Automatic Gain Control (AGC) .....	75
8b/10b Encoding .....	48	RSSI .....	76
Sport Mode .....	49	2FSK/GFSK/MSK/GMSK Demodulation .....	78
Packet Structure in Sport Mode .....	49	Clock Recovery .....	80
Sport Mode in Transmit .....	49	OOK Demodulation .....	80
Sport Mode in Receive .....	49	Recommended Receiver Settings for 2FSK/GFSK/MSK/GMSK .....	81
Transmit Bit Latencies in Sport Mode .....	49	Recommended Receiver Settings for OOK .....	82
Interrupt Generation .....	52		

Peripheral Features.....	83	Host Processor Interface.....	85
Analog-to-Digital Converter.....	83	PA/LNA Matching.....	85
Temperature Sensor.....	83	Command Reference.....	87
Test DAC.....	83	Register Maps.....	88
Transmit Test Modes.....	83	BBRAM Register Description.....	90
Silicon Revision Readback.....	83	MCR Register Description.....	100
Applications Information.....	84	Outline Dimensions.....	109
Application Circuit.....	84	Ordering Guide.....	109

## REVISION HISTORY

### 7/12—Rev. B to Rev. C

Changes to Features Section.....	1
Changed 1.8 V to 2.2 V, General Description Section.....	4
Changed 1.8 V to 2.2 V, Table 1 Summary.....	6
Changed 1.8 V to 2.2 V, Table 2.....	7
Changes to Table 3.....	9
Changes to Table 5.....	14
Changes to $V_{DD}$ Parameter, Table 6.....	15
Changes to Timing Specifications Section.....	16
Deleted $t_1$ from Table 7, Figure 2, and Figure 3.....	16
Changes to Table 9.....	18
Changes to Figure 5 to Figure 10.....	20
Changes to Figure 11, Figure 12 Caption, Figure 13 and Figure 14 Caption.....	21
Changes to Figure 19 Caption to Figure 21 Caption.....	22
Changes to Figure 26 Caption.....	23
Changes to Figure 34 Caption.....	24
Changes to Figure 61 Caption and Figure 64 Caption.....	29
Changes to Figure 72.....	31
Changes to PHY_SLEEP Section.....	33
Changes to Initialization After Application of Power Section, Initialization After Issuing the CMD_HW_RESET Command Section, Initialization on Transitioning from PHY_SLEEP (After CS Is Brought Low) Section, and Initialization After a WUC Timeout Section.....	35
Changes to CMD_RAM_LOAD_DONE (0xC7) Section.....	37
Deleted CMD_SYNC (0xA2) Section.....	37
Changes to State Transition and Command Timing Section.....	38
Changes to Table 11 and Table 12.....	39
Changes to Addressing Section.....	45
Changes to Example Address Check Section, Table 18, and CRC Section.....	46
Changes to Figure 79.....	47
Changes to Figure 81 and Figure 82.....	50
Changes to Figure 83 and Figure 84.....	51
Changes to CMD_FINISHED Description, Table 24.....	53
Changes to Command Access Section.....	56
Changes to Figure 97.....	63
Changes to Table 29.....	68
Added Calibrating the RC Oscillator Section, Performing a Fine Calibration of the RC Oscillator Section, and Performing a Coarse Calibration of the RC Oscillator Section.....	69

Added Figure 103; Renumbered Sequentially.....	70
Changes to Writing a Module to Program RAM Section.....	71
Changes to Automatic PA Ramp Section Equation and Image Channel Rejection Section.....	75
Changes to Temperature Sensor Section and Table 43.....	83
Changes to Figure 110.....	84
Changes to Figure 111 and Figure 112.....	85
Changes to Support for External PA and LNA Control Section and Table 45.....	86
Changes to CMD_SYNC Description Column, Table 46.....	87
Changes to Table 48.....	88
Changes to Table 49.....	89
Changes to SYNTH_LUT_CONTROL_1 Description Column, Table 70.....	93
Changes to Table 78.....	96
Changes to Table 79.....	97
Changes to Table 84 and Table 86.....	98
Changes to Table 94.....	99
Added Table 95, Table 96, and Table 97; Renumbered Sequentially.....	100
Changes to Table 101.....	101
Added Table 124 and Table 125.....	105

### 3/11—Rev. A to Rev. B

Changes to RSSI Method 3, Formula.....	72
Changes to RSSI Method 4, Step 3.....	72
Changes to RSSI Method 4, Step 5 Formula and Formula Approximation.....	73
Added Register 0x361 to Table 49.....	85
Added Table 129, Renumbered Subsequent Tables.....	104

### 2/11—Rev. 0 to Rev. A

Changes to Table 9, DGUARD Description.....	18
Changes to Sport Mode in Receive Section.....	47
Changes to Crystal Oscillator Section, Typical Crystal Load Capacitance Tuning Range Value, and to Table 31.....	70
Changes to RSSI Method 3 Section.....	72
Changes to RSSI Method 4 Section.....	73
Changes to Table 41, 9.6 kbps and 1 kbps Data Rate Setup Values.....	78
Changes to Table 108, ADC_PD_N Description.....	100

### 8/10—Revision 0: Initial Version



The communications processor provides support for generic packet formats. The packet format is highly flexible and fully programmable, thereby ensuring its compatibility with proprietary packet profiles. In transmit mode, the communications processor can be configured to add preamble, sync word, and CRC to the payload data stored in packet RAM. In receive mode, the communications processor can detect and interrupt the host processor on reception of preamble, sync word, address, and CRC and store the received payload to packet RAM. The ADF7023 uses an efficient interrupt system comprising MAC level interrupts and PHY level interrupts that can be individually set. The payload data plus the 16-bit CRC can be encoded/decoded using Manchester or 8b/10b encoding. Alternatively, data whitening and dewatering can be applied.

The smart wake mode (SWM) allows the ADF7023 to wake up autonomously from sleep using the internal wake-up timer without intervention from the host processor. After wake-up, the ADF7023 is controlled by the communications processor. This functionality allows carrier sense, packet sniffing, and packet reception while the host processor is in sleep, thereby reducing overall system current consumption. The smart wake mode can wake the host processor on an interrupt condition.

These interrupt conditions can be configured to include the reception of valid preamble, sync word, CRC, or address match. Wake-up from sleep mode can also be triggered by the host processor. For systems requiring very accurate wake-up timing, a 32 kHz oscillator can be used to drive the wake-up timer. Alternatively, the internal RC oscillator can be used, which gives lower current consumption in sleep.

The ADF7023 features an advanced encryption standard (AES) engine with hardware acceleration that provides 128-bit block encryption and decryption with key sizes of 128 bits, 192 bits, and 256 bits. Both electronic code book (ECB) and Cipher Block Chaining Mode 1 (CBC Mode 1) are supported. The AES engine can be used to encrypt/decrypt packet data and can be used as a standalone engine for encryption/decryption by the host processor. The AES engine is enabled on the ADF7023 by downloading the AES software module to program RAM. The AES software module is available from Analog Devices, Inc.

An on-chip, 8-bit ADC provides readback of an external analog input, the RSSI signal, or an integrated temperature sensor. An integrated battery voltage monitor raises an interrupt flag to the host processor whenever the battery voltage drops below a user-defined threshold.

## SPECIFICATIONS

$V_{DD} = V_{DDBAT1} = V_{DDBAT2} = 2.2 \text{ V to } 3.6 \text{ V}$ ,  $GND = 0 \text{ V}$ ,  $T_A = T_{MIN}$  to  $T_{MAX}$ , unless otherwise noted. Typical specifications are at  $V_{DD} = 3 \text{ V}$ ,  $T_A = 25^\circ\text{C}$ .

### RF AND SYNTHESIZER SPECIFICATIONS

Table 1.

Parameter	Min	Typ	Max	Unit	Test Conditions
<b>RF CHARACTERISTICS</b>					
Frequency Ranges	862		928	MHz	
	431		464	MHz	
<b>PHASE-LOCKED LOOP</b>					
Channel Frequency Resolution		396.7		Hz	
Phase Noise (In-Band)		-88		dBc/Hz	10 kHz offset, PA output power = 10 dBm, RF = 868 MHz
Phase Noise at Offset of					
1 MHz		-126		dBc/Hz	PA output power = 10 dBm, RF frequency = 868 MHz
2 MHz		-131		dBc/Hz	PA output power = 10 dBm, RF frequency = 868 MHz
10 MHz		-142		dBc/Hz	PA output power = 10 dBm, RF frequency = 868 MHz
VCO Calibration Time		142		$\mu\text{s}$	
Synthesizer Settling Time		56		$\mu\text{s}$	Frequency synthesizer settles to within $\pm 5$ ppm of the target frequency within this time following the VCO calibration, transmit, and receive, 2FSK/GFSK/MSK/GMSK
<b>CRYSTAL OSCILLATOR</b>					
Crystal Frequency		26		MHz	Parallel load resonant crystal
Recommended Load Capacitance	7		18	pF	
Maximum Crystal ESR		1800		$\Omega$	26 MHz crystal with 18 pF load capacitance
Pin Capacitance		2.1		pF	Capacitance for XOSC26P and XOSC26N
Start-Up Time		310		$\mu\text{s}$	26 MHz crystal with 7 pF load capacitance
		388		$\mu\text{s}$	26 MHz crystal with 18 pF load capacitance
<b>SPURIOUS EMISSIONS</b>					
Integer Boundary Spurious					
910.1 MHz		-39		dBc	Using 130 kHz synthesizer bandwidth, integer boundary spur at 910 MHz ( $26 \text{ MHz} \times 35$ ), inside synthesizer loop bandwidth
911.0 MHz		-79		dBc	Using 130 kHz synthesizer bandwidth, integer boundary spur at 910 MHz ( $26 \text{ MHz} \times 35$ ), outside synthesizer loop bandwidth
Reference Spurious					
868 MHz/915 MHz		-80		dBc	Using 130 kHz synthesizer bandwidth and using 92 kHz synthesizer bandwidth (default for PHY_RX)
Clock-Related Spur Level		-60		dBc	Measured in a span of $\pm 350$ MHz for synthesizer bandwidth = 92 kHz, RF frequency = 868.95 MHz, PA output power = 10 dBm, $V_{DD} = 3.6 \text{ V}$ , single-ended PA used

## TRANSMITTER SPECIFICATIONS

Table 2.

Parameter	Min	Typ	Max	Unit	Test Conditions
DATA RATE					
2FSK/GFSK/MSK/GMSK	1		300	kbps	Manchester encoding enabled (Manchester chip rate = 2 × data rate)
OOK	2.4		19.2	kbps	
Data Rate Resolution		100		bps	
MODULATION ERROR RATE (MER)					RF frequency = 928 MHz, GFSK
10 kbps to 49.5 kbps		25.4		dB	Modulation index = 1
49.6 kbps to 129.5 kbps		25.3		dB	Modulation index = 1
129.6 kbps to 179.1 kbps		23.9		dB	Modulation index = 0.5
179.2 kbps to 239.9 kbps		23.3		dB	Modulation index = 0.5
240 kbps to 300 kbps		23		dB	Modulation index = 0.5
MODULATION					
2FSK/GFSK/MSK/GMSK Frequency Deviation	0.1		409.5	kHz	Nonprogrammable
Deviation Frequency Resolution		100		Hz	
Gaussian Filter BT		0.5			
OOK					
PA Off Feedthrough		-94		dBm	Data rate = 19.2 kbps (38.4 kbps Manchester encoded), PA output = 10 dBm, PA ramp rate = 64 codes/bit
VCO Frequency Pulling		30		kHz rms	
SINGLE-ENDED PA					
Maximum Power <sup>1</sup>		13.5		dBm	Programmable, separate PA and LNA match <sup>2</sup>
Minimum Power		-20		dBm	
Transmit Power Variation vs. Temperature		±0.5		dB	From -40°C to +85°C, RF frequency = 868 MHz
Transmit Power Variation vs. V <sub>DD</sub>		±1		dB	From 2.2 V to 3.6 V, RF frequency = 868 MHz
Transmit Power Flatness		±1		dB	From 902 MHz to 928 MHz and 863 MHz to 870 MHz
Programmable Step Size					
-20 dBm to +13.5 dBm		0.5		dB	Programmable in 63 steps
DIFFERENTIAL PA					
Maximum Power <sup>1</sup>		10		dBm	Programmable
Minimum Power		-20		dBm	
Transmit Power Variation vs. Temperature		±1		dB	From -40°C to +85°C, RF frequency = 868 MHz
Transmit Power Variation vs. V <sub>DD</sub>		±2		dB	From 2.2 V to 3.6 V, RF frequency = 868 MHz
Transmit Power Flatness		±1		dB	From 863 MHz to 870 MHz
Programmable Step Size					
-20 dBm to +10 dBm		0.5		dB	Programmable in 63 steps
HARMONICS					868 MHz, unfiltered conductive, PA output power = 10 dBm
Single-Ended PA					
Second Harmonic		-15.1		dBc	
Third Harmonic		-29.3		dBc	
All Other Harmonics		-47.6		dBc	
Differential PA					
Second Harmonic		-23.2		dBc	
Third Harmonic		-25.2		dBc	
All Other Harmonics		-24.2		dBc	

Parameter	Min	Typ	Max	Unit	Test Conditions
OPTIMUM PA LOAD IMPEDANCE					
Single-Ended PA, in Transmit Mode					
$f_{RF} = 915$ MHz		50.8 + j10.2		$\Omega$	
$f_{RF} = 868$ MHz		45.5 + j12.1		$\Omega$	
$f_{RF} = 433$ MHz		46.8 + j19.9		$\Omega$	
Single-Ended PA, in Receive Mode					
$f_{RF} = 915$ MHz		9.4 – j124		$\Omega$	
$f_{RF} = 868$ MHz		9.5 – j130.6		$\Omega$	
$f_{RF} = 433$ MHz		11.9 – j260.1		$\Omega$	
Differential PA, in Transmit Mode					
$f_{RF} = 915$ MHz		20.5 + j36.4		$\Omega$	Load impedance between RFIO_1P and RFIO_1N to ensure maximum output power
$f_{RF} = 868$ MHz		24.7 + j36.5		$\Omega$	
$f_{RF} = 433$ MHz		55.6 + j81.5		$\Omega$	

<sup>1</sup> Measured as the maximum unmodulated power.

<sup>2</sup> A combined single-ended PA and LNA match can reduce the maximum achievable output power by up to 1 dB.



## RECEIVER SPECIFICATIONS

Table 3.

Parameter	Min	Typ	Max	Unit	Test Conditions
2FSK/GFSK/MSK/GMSK INPUT SENSITIVITY, BIT ERROR RATE (BER)					At BER = $1E-3$ , RF frequency = 433 MHz, 868 MHz, 915 MHz, LNA and PA matched separately <sup>1</sup>
1.0 kbps		-116		dBm	Frequency deviation = 4.8 kHz, IF filter bandwidth = 100 kHz
10 kbps		-111		dBm	Frequency deviation = 9.6 kHz, IF filter bandwidth = 100 kHz
38.4 kbps		-107.5		dBm	Frequency deviation = 20 kHz, IF filter bandwidth = 100 kHz
50 kbps		-106.5		dBm	Frequency deviation = 12.5 kHz, IF filter bandwidth = 100 kHz
100 kbps		-105		dBm	Frequency deviation = 25 kHz, IF filter bandwidth = 100 kHz
150 kbps		-104		dBm	Frequency deviation = 37.5 kHz, IF filter bandwidth = 150 kHz
200 kbps		-103		dBm	Frequency deviation = 50 kHz, IF filter bandwidth = 200 kHz
300 kbps		-100.5		dBm	Frequency deviation = 75 kHz, IF filter bandwidth = 300 kHz
2FSK/GFSK/MSK/GMSK INPUT SENSITIVITY, PACKET ERROR RATE (PER)					At PER = 1%, RF frequency = 433 MHz, 868 MHz, 915 MHz, LNA and PA matched separately <sup>1</sup> , packet length = 128 bits, packet mode
1.0 kbps		-115.5		dBm	Frequency deviation = 4.8 kHz, IF filter bandwidth = 100 kHz
9.6 kbps		-110.6		dBm	Frequency deviation = 9.6 kHz, IF filter bandwidth = 100 kHz
38.4 kbps		-106		dBm	Frequency deviation = 20 kHz, IF filter bandwidth = 100 kHz
50 kbps		-104.3		dBm	Frequency deviation = 12.5 kHz, IF filter bandwidth = 100 kHz
100 kbps		-102.6		dBm	Frequency deviation = 25 kHz, IF filter bandwidth = 100 kHz
150 kbps		-101		dBm	Frequency deviation = 37.5 kHz, IF filter bandwidth = 150 kHz
200 kbps		-99.1		dBm	Frequency deviation = 50 kHz, IF filter bandwidth = 200 kHz
300 kbps		-97.9		dBm	Frequency deviation = 75 kHz, IF filter bandwidth = 300 kHz
OOK INPUT SENSITIVITY, PACKET ERROR RATE (PER)					At PER = 1%, RF frequency = 433 MHz, 868 MHz, 915 MHz, LNA and PA matched separately <sup>1</sup> , packet length = 128 bits, packet mode, IF filter bandwidth = 100 kHz
19.2 kbps (38.4 kcps, Manchester Encoded)		-104.7		dBm	
2.4 kbps (4.8 kcps, Manchester Encoded)		-109.7		dBm	
LNA AND MIXER, INPUT IP3					Receiver LO frequency ( $f_{LO}$ ) = 914.8 MHz, $f_{SOURCE1} = f_{LO} + 0.4$ MHz, $f_{SOURCE2} = f_{LO} + 0.7$ MHz
Minimum LNA Gain		-11.5		dBm	
Maximum LNA Gain		-12.2		dBm	
LNA AND MIXER, INPUT IP2					Receiver LO frequency ( $f_{LO}$ ) = 920.8 MHz, $f_{SOURCE1} = f_{LO} + 1.1$ MHz, $f_{SOURCE2} = f_{LO} + 1.3$ MHz
Max LNA Gain, Max Mixer Gain		18.5		dBm	
Min LNA Gain, Min Mixer Gain		27		dBm	

Parameter	Min	Typ	Max	Unit	Test Conditions
LNA AND MIXER, 1 dB COMPRESSION POINT					RF frequency = 915 MHz
Max LNA Gain, Max Mixer Gain		-21.9		dBm	
Min LNA Gain, Min Mixer Gain		-21		dBm	
ADJACENT CHANNEL REJECTION					
CW Interferer					Wanted signal 3 dB above the input sensitivity level (BER = 10 <sup>-3</sup> ), CW interferer power level increased until BER = 10 <sup>-3</sup> , image calibrated
200 kHz Channel Spacing		38		dB	IF BW = 100 kHz, wanted signal: F <sub>DEV</sub> = 12.5 kHz, DR = 50 kbps
300 kHz Channel Spacing		39		dB	IF BW = 100 kHz, wanted signal: F <sub>DEV</sub> = 25 kHz, DR = 100 kbps
		38		dB	IF BW = 150 kHz, wanted signal: F <sub>DEV</sub> = 37.5 kHz, DR = 150 kbps
400 kHz Channel Spacing		40		dB	IF BW = 200 kHz, wanted signal: F <sub>DEV</sub> = 50 kHz, DR = 200 kbps
600 kHz Channel Spacing		41		dB	IF BW = 300 kHz, wanted signal: F <sub>DEV</sub> = 75 kHz, DR = 300 kbps
Modulated Interferer					Wanted signal 3 dB above the input sensitivity level (BER = 10 <sup>-3</sup> ), modulated interferer with the same modulation as the wanted signal; interferer power level increased until BER = 10 <sup>-3</sup> , image calibrated
200 kHz Channel Spacing		38		dB	IF BW = 100 kHz, wanted signal: F <sub>DEV</sub> = 12.5 kHz, DR = 50 kbps
300 kHz Channel Spacing		36		dB	IF BW = 100 kHz, wanted signal: F <sub>DEV</sub> = 25 kHz, DR = 100 kbps
300 kHz Channel Spacing		36		dB	IF BW = 150 kHz, wanted signal: F <sub>DEV</sub> = 37.5 kHz, DR = 150 kbps
400 kHz Channel Spacing		34		dB	IF BW = 200 kHz, wanted signal: F <sub>DEV</sub> = 50 kHz, DR = 200 kbps
600 kHz Channel Spacing		35		dB	IF BW = 300 kHz, wanted signal: F <sub>DEV</sub> = 75 kHz, DR = 300 kbps
CO-CHANNEL REJECTION		-4		dB	Desired signal 10 dB above the input sensitivity level (BER = 10 <sup>-3</sup> ), data rate = 38.4 kbps, frequency deviation = 20 kHz, RF frequency = 868 MHz
BLOCKING					Desired signal 3 dB above the input sensitivity level (BER = 10 <sup>-3</sup> ) of -107.5 dBm (data rate = 38.4 kbps), modulated interferer power level increased until BER = 10 <sup>-3</sup> (see the Typical Performance Characteristics section for blocking at other offsets and IF bandwidths)
RF Frequency = 433 MHz					
±2 MHz		68		dB	
±10 MHz		76		dB	
RF Frequency = 868 MHz					
±2 MHz		66		dB	
±10 MHz		74		dB	
RF Frequency = 915 MHz					
±2 MHz		66		dB	
±10 MHz		74		dB	

Parameter	Min	Typ	Max	Unit	Test Conditions
BLOCKING, ETSI EN 300 220					Measurement procedure as per ETSI EN 300 220-1 V2.3.1; desired signal 3 dB above the ETSI EN 300 220 reference sensitivity level of -99 dBm, IF bandwidth = 100 kHz, data rate = 38.4 kbps, unmodulated interferer; see the Typical Performance Characteristics section for blocking at other offsets and IF bandwidths, RF frequency = 868 MHz
±2 MHz		-28		dBm	
±10 MHz		-20.5		dBm	
WIDEBAND INTERFERENCE REJECTION		75		dB	RF frequency = 868 MHz, swept from 10 MHz to 100 MHz either side of the RF frequency
IMAGE CHANNEL ATTENUATION					Measured as image attenuation at the IF filter output, carrier wave interferer at 400 kHz below the channel frequency, 100 kHz IF filter bandwidth
868 MHz, 915 MHz		36/45		dB	Uncalibrated/calibrated
433 MHz		40/54		dB	Uncalibrated/calibrated
AFC					
Accuracy		1		kHz	
Maximum Pull-In Range					Achievable pull-in range dependent on discriminator bandwidth and modulation
300 kHz IF Filter Bandwidth		±150		kHz	
200 kHz IF Filter Bandwidth		±100		kHz	
150 kHz IF Filter Bandwidth		±75		kHz	
100 kHz IF Filter Bandwidth		±50		kHz	
PREAMBLE LENGTH					Minimum number of preamble bits to ensure the minimum packet error rate across the full input power range
AFC Off, AGC Lock on Sync Word Detection					
38.4 kbps		8		Bits	
300 kbps		24		Bits	
AFC On, AFC and AGC Lock on Preamble Detection					
9.6 kbps		44		Bits	
38.4 kbps		44		Bits	
50 kbps		50		Bits	
100 kbps		52		Bits	
150 kbps		54		Bits	
200 kbps		58		Bits	
300 kbps		64		Bits	
AFC On, AFC and AGC Lock on Sync Word Detection					
38.4 kbps		14		Bits	
300 kbps		32		Bits	
RSSI					
Range at Input		-97 to -26		dBm	
Linearity		±2		dB	
Absolute Accuracy		±3		dB	
SATURATION (MAXIMUM INPUT LEVEL)					
2FSK/GFSK/MSK/GMSK		12		dBm	
OOK		-13		dBm	OOK modulation depth = 20 dB
		10		dBm	OOK modulation depth = 60 dB

Parameter	Min	Typ	Max	Unit	Test Conditions
LNA INPUT IMPEDANCE					
Receive Mode					
$f_{RF} = 915 \text{ MHz}$		75.9 – j32.3		$\Omega$	
$f_{RF} = 868 \text{ MHz}$		78.0 – j32.4		$\Omega$	
$f_{RF} = 433 \text{ MHz}$		95.5 – j23.9		$\Omega$	
Transmit Mode					
$f_{RF} = 915 \text{ MHz}$		7.6 + j9.2		$\Omega$	
$f_{RF} = 868 \text{ MHz}$		7.7 + j8.6		$\Omega$	
$f_{RF} = 433 \text{ MHz}$		7.9 + j4.6		$\Omega$	
RX SPURIOUS EMISSIONS <sup>2</sup>					
Maximum <1 GHz		–66		dBm	At antenna input, unfiltered conductive
Maximum >1 GHz		–62		dBm	At antenna input, unfiltered conductive

<sup>1</sup> Sensitivity for combined matching network case is typically 1 dB less than separate matching networks.

<sup>2</sup> Follow the matching and layout guidelines to achieve the relevant FCC/ETSI specifications.

## TIMING AND DIGITAL SPECIFICATIONS

Table 4.

Parameter	Min	Typ	Max	Unit	Test Conditions
RX AND TX TIMING PARAMETERS					
PHY_ON to PHY_RX (on CMD_PHY_RX)		300		$\mu\text{s}$	See the State Transition and Command Timing section for more details
PHY_ON to PHY_TX (on CMD_PHY_TX)		296		$\mu\text{s}$	Includes VCO calibration and synthesizer settling, does not include PA ramp-up
LOGIC INPUTS					
Input High Voltage, $V_{\text{INH}}$	$0.7 \times V_{\text{DD}}$			V	
Input Low Voltage, $V_{\text{INL}}$			$0.2 \times V_{\text{DD}}$	V	
Input Current, $I_{\text{INH}}/I_{\text{INL}}$			$\pm 1$	$\mu\text{A}$	
Input Capacitance, $C_{\text{IN}}$			10	pF	
LOGIC OUTPUTS					
Output High Voltage, $V_{\text{OH}}$	$V_{\text{DD}} - 0.4$			V	$I_{\text{OH}} = 500 \mu\text{A}$
Output Low Voltage, $V_{\text{OL}}$			0.4	V	$I_{\text{OL}} = 500 \mu\text{A}$
GPIO Rise/Fall			5	ns	
GPIO Load			10	pF	
Maximum Output Current		5		mA	
ATB OUTPUTS					
ADCIN_ATB3 and ATB4					
Output High Voltage, $V_{\text{OH}}$		1.8		V	
Output Low Voltage, $V_{\text{OL}}$		0.1		V	
Maximum Output Current		0.5		mA	
XOSC32KP_GP5_ATB1 and XOSC32KN_ATB2					
Output High Voltage, $V_{\text{OH}}$		$V_{\text{DD}}$		V	
Output Low Voltage, $V_{\text{OL}}$		0.1		V	
Maximum Output Current		5		mA	Used for external PA and LNA control

## AUXILIARY BLOCK SPECIFICATIONS

Table 5.

Parameter	Min	Typ	Max	Unit	Test Conditions
32 kHz RC OSCILLATOR					
Frequency		32.768		kHz	After calibration
Frequency Accuracy		1.5		%	After calibration at 25°C
Frequency Drift					
Temperature Coefficient		0.14		%/°C	
Voltage Coefficient		4		%/V	
Calibration Time		1.25		ms	
32 kHz XTAL OSCILLATOR					
Frequency		32.768		kHz	
Start-Up Time		630		ms	32.768 kHz crystal with 7 pF load capacitance
WAKE UP CONTROLLER (WUC)					
Hardware Timer					
Wake-Up Period	$61 \times 10^{-6}$		$1.31 \times 10^5$	sec	
Firmware Timer					
Wake-Up Period	1		$2^{16}$	Hardware periods	Firmware counter counts of the number of hardware wake-ups, resolution of 16 bits
ADC					
Resolution		8		Bits	
DNL		±1		LSB	$V_{DD}$ from 2.2 V to 3.6 V, $T_A = 25^\circ\text{C}$
INL		±1		LSB	$V_{DD}$ from 2.2 V to 3.6 V, $T_A = 25^\circ\text{C}$
Conversion Time		1		µs	
Input Capacitance		12.4		pF	
BATTERY MONITOR					
Absolute Accuracy		±45		mV	
Alarm Voltage Set Point	1.7		2.7	V	
Alarm Voltage Step Size		62		mV	5-bit resolution
Start-Up Time			100	µs	
Current Consumption		30		µA	When enabled
TEMPERATURE SENSOR					
Range	-40		+85	°C	
Resolution		0.3		°C	With averaging
Accuracy of Temperature Readback		+7/-4		°C	Over temperature range -40°C to +85°C (calibrated at +25°C)

## GENERAL SPECIFICATIONS

Table 6.

Parameter	Min	Typ	Max	Unit	Test Conditions
TEMPERATURE RANGE, T <sub>A</sub>	-40		+85	°C	
VOLTAGE SUPPLY					
V <sub>DD</sub>	2.2		3.6	V	Applied to VDDBAT1 and VDDBAT2
TRANSMIT CURRENT CONSUMPTION					In the PHY_TX state, single-ended PA matched to 50 Ω, differential PA matched to 100 Ω, separate single-ended PA and LNA match, combined differential PA and LNA match
Single-Ended PA, 433 MHz					
-10 dBm		8.7		mA	
0 dBm		12.2		mA	
10 dBm		23.3		mA	
13.5 dBm		32.1		mA	
Differential PA, 433 MHz					
-10 dBm		7.9		mA	
0 dBm		11		mA	
5 dBm		15		mA	
10 dBm		22.6		mA	
Single-Ended PA, 868 MHz/915 MHz					
-10 dBm		10.3		mA	
0 dBm		13.3		mA	
10 dBm		24.1		mA	
13.5 dBm		32.1		mA	
Differential PA, 868 MHz/915 MHz					
-10 dBm		9.3		mA	
0 dBm		12		mA	
5 dBm		16.7		mA	
10 dBm		28		mA	
POWER MODES					
PHY_SLEEP (Deep Sleep Mode 2)		0.18		μA	Sleep mode, wake-up configuration values (BBRAM) not retained
PHY_SLEEP (Deep Sleep Mode 1)		0.33		μA	Sleep mode, wake-up configuration values (BBRAM) retained
PHY_SLEEP (RCO Wake Mode)		0.75		μA	WUC active, RC oscillator running, wake-up configuration values retained (BBRAM)
PHY_SLEEP (XTO Wake Mode)		1.28		μA	WUC active, 32 kHz crystal running, wake-up configuration values retained (BBRAM)
PHY_OFF		1		mA	Device in PHY_OFF state, 26 MHz oscillator running, digital and synthesizer regulators active, all register values retained
PHY_ON		1		mA	Device in PHY_ON state, 26 MHz oscillator running, digital, synthesizer, VCO, and RF regulators active, baseband filter calibration performed, all register values retained
PHY_RX		12.8		mA	Device in PHY_RX state
SMART WAKE MODE					
		21.78		μA	Average current consumption Autonomous reception every 1 sec, with receive dwell time of 1.25 ms, using RC oscillator, data rate = 38.4 kbps
		11.75		μA	Autonomous reception every 1 sec, with receive dwell time of 0.5 ms, using RC oscillator, data rate = 300 kbps

**TIMING SPECIFICATIONS**

$V_{DD} = V_{DDBAT1} = V_{DDBAT2} = 2.2\text{ V to }3.6\text{ V}$ ,  $V_{GND} = GND = 0\text{ V}$ ,  $T_A = T_{MIN}$  to  $T_{MAX}$ , unless otherwise noted.

**Table 7. SPI Interface Timing**

Parameter	Limit	Unit	Test Conditions/Comments
$t_2$	85	ns min	$\overline{CS}$ low to SCLK setup time
$t_3$	85	ns min	SCLK high time
$t_4$	85	ns min	SCLK low time
$t_5$	170	ns min	SCLK period
$t_6$	10	ns max	SCLK falling edge to MISO delay
$t_7$	5	ns min	MOSI to SCLK rising edge setup time
$t_8$	5	ns min	MOSI to SCLK rising edge hold time
$t_9$	85	ns min	SCLK falling edge to $\overline{CS}$ hold time
$t_{11}$	270	ns min	$\overline{CS}$ high time
$t_{12}$	310	$\mu\text{s typ}$	$\overline{CS}$ low to MISO high wake-up time, 26 MHz crystal with 7 pF load capacitance, $T_A = 25^\circ\text{C}$
$t_{13}$	20	ns max	SCLK rise time
$t_{14}$	20	ns max	SCLK fall time

**Timing Diagrams**

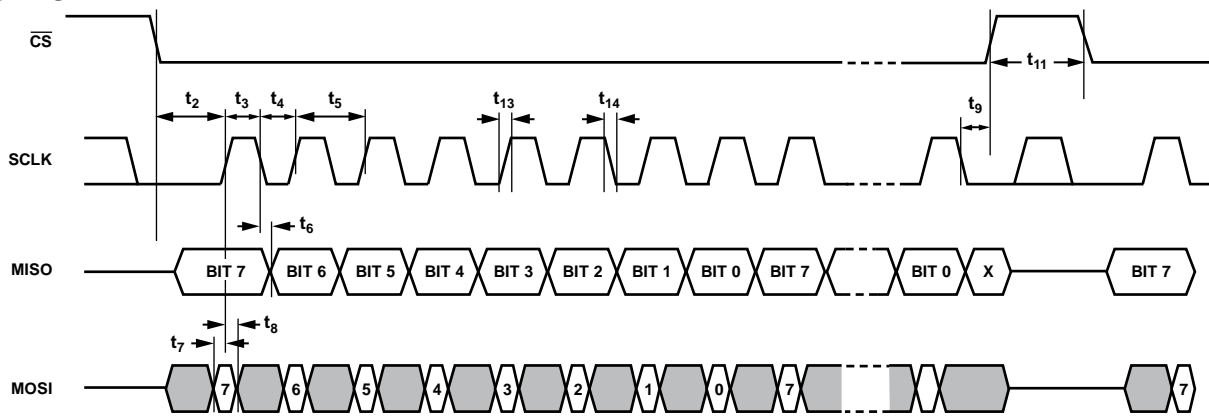

Figure 2. SPI Interface Timing

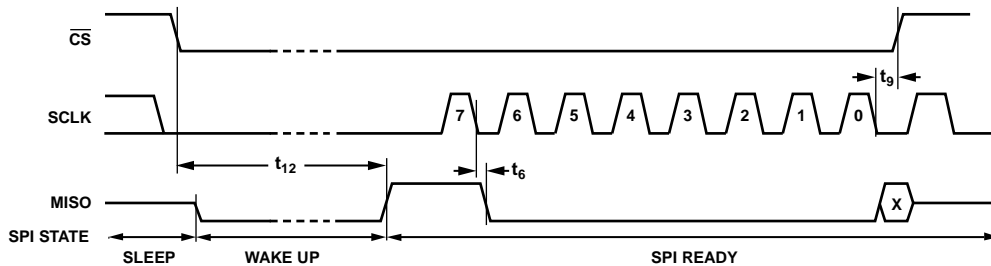

Figure 3. PHY\_SLEEP to SPI Ready State Timing (SPI Ready T12 After Falling Edge of  $\overline{CS}$ )



## ABSOLUTE MAXIMUM RATINGS

$T_A = 25^\circ\text{C}$ , unless otherwise noted.

Table 8.

Parameter	Rating
VDDBAT1, VDDBAT2 to GND	-0.3 V to +3.96 V
Operating Temperature Range	
Industrial	-40°C to +85°C
Storage Temperature Range	-65°C to +125°C
Maximum Junction Temperature	150°C
LFCSP $\theta_{JA}$ Thermal Impedance	26°C/W
Reflow Soldering	
Peak Temperature	260°C
Time at Peak Temperature	40 sec

Stresses above those listed under Absolute Maximum Ratings may cause permanent damage to the device. This is a stress rating only; functional operation of the device at these or any other conditions above those indicated in the operational section of this specification is not implied. Exposure to absolute maximum rating conditions for extended periods may affect device reliability.

Connect the exposed paddle of the LFCSP package to ground.

This device is a high performance, RF integrated circuit with an ESD rating of <2 kV; it is ESD sensitive. Proper precautions should be taken for handling and assembly.

### ESD CAUTION



**ESD (electrostatic discharge) sensitive device.** Charged devices and circuit boards can discharge without detection. Although this product features patented or proprietary protection circuitry, damage may occur on devices subjected to high energy ESD. Therefore, proper ESD precautions should be taken to avoid performance degradation or loss of functionality.

## PIN CONFIGURATION AND FUNCTION DESCRIPTIONS



- NOTES**  
 1. NC = NO CONNECT.  
 2. CONNECT EXPOSED PAD TO GND.

08291-104

Figure 4. Pin Configuration

Table 9. Pin Function Descriptions

Pin No.	Mnemonic	Function
1	CREGRF1	Regulator Voltage for RF. A 220 nF capacitor should be placed between this pin and ground for regulator stability and noise rejection.
2	RBIAS	External Bias Resistor. A 36 kΩ resistor with 2% tolerance should be used.
3	CREGRF2	Regulator Voltage for RF. A 220 nF capacitor should be placed between this pin and ground for regulator stability and noise rejection.
4	RFIO_1P	LNA Positive Input in Receive Mode. PA positive output in transmit mode with differential PA.
5	RFIO_1N	LNA Negative Input in Receive Mode. PA negative output in transmit mode with differential PA.
6	RFO2	Single-Ended PA Output.
7	VDDBAT2	Power Supply Pin Two. Decoupling capacitors to the ground plane should be placed as close as possible to this pin.
8	NC	No Connect.
9	CREGVCO	Regulator Voltage for the VCO. A 220 nF capacitor should be placed between this pin and ground for regulator stability and noise rejection.
10	VCOGUARD	Guard/Screen for VCO. This pin should be connected to Pin 9.
11	CREGSYNTH	Regulator Voltage for the Synthesizer. A 220 nF capacitor should be placed between this pin and ground for regulator stability and noise rejection.
12	CWAKEUP	External Capacitor for Wake-Up Control. A 150 nF capacitor should be placed between this pin and ground.
13	XOSC26P	The 26 MHz reference crystal should be connected between this pin and XOSC26N. If an external reference is connected to XOSC26N, this pin should be left open circuited.
14	XOSC26N	The 26 MHz reference crystal should be connected between this pin and XOSC26P. Alternatively, an external 26 MHz reference signal can be ac-coupled to this pin.
15	DGUARD	Internal Guard/Screen for the Digital Circuitry. Connect this pin to Pin 16, CREGDIG1.
16	CREGDIG1	Regulator Voltage for Digital Section of the Chip. A 220 nF capacitor should be placed between this pin and ground for regulator stability and noise rejection.
17	GP0	Digital GPIO Pin 0.
18	GP1	Digital GPIO Pin 1.
19	GP2	Digital GPIO Pin 2.
20	IRQ_GP3	Interrupt Request, Digital GPIO Test Pin 3.
21	MISO	Serial Port Master In/Slave Out.

Pin No.	Mnemonic	Function
22	SCLK	Serial Port Clock.
23	MOSI	Serial Port Master Out/Slave In.
24	$\overline{\text{CS}}$	Chip Select (Active Low). A pull-up resistor of 100 k $\Omega$ to $V_{\text{DD}}$ is recommended to prevent the host processor from inadvertently waking the ADF7023 from sleep.
25	GP4	Digital GPIO Test Pin 4.
26	CREGDIG2	Regulator Voltage for Digital Section of the Chip. A 220 nF capacitor should be placed between this pin and ground for regulator stability and noise rejection.
27	XOSC32KP_GP5_ATB1	Digital GPIO Test Pin 5. A 32 kHz watch crystal can be connected between this pin and XOSC32KN_ATB2. Analog Test Pin 1.
28	XOSC32KN_ATB2	A 32 kHz watch crystal can be connected between this pin and XOSC32KP_GP5_ATB1. Analog Test Pin 2.
29	VDDBAT1	Digital Power Supply Pin One. Decoupling capacitors to the ground plane should be placed as close as possible to this pin.
30	ADCIN_ATB3	Analog-to-Digital Converter Input. Can be configured as an external PA enable signal. Analog Test Pin 3.
31	ATB4	Analog Test Pin 4. Can be configured as an external LNA enable signal.
32	ADCVREF	ADC Reference Output. A 220 nF capacitor should be placed between this pin and ground for adequate noise rejection.
EPAD	GND	Exposed Package Paddle. Connect to GND.

TYPICAL PERFORMANCE CHARACTERISTICS

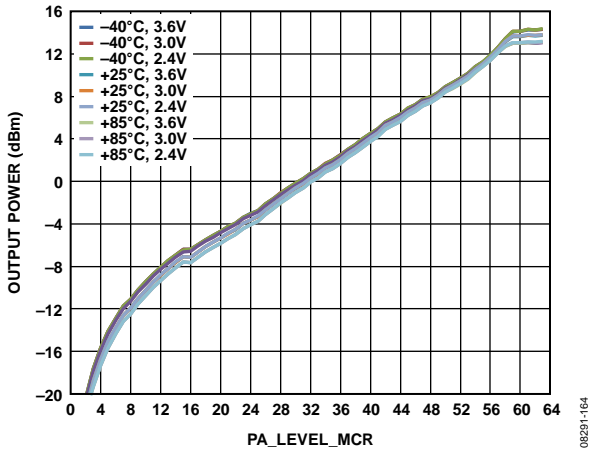

Figure 5. Single-Ended PA at 433 MHz: Output Power vs. PA\_LEVEL\_MCR Setting, Temperature, and  $V_{DD}$

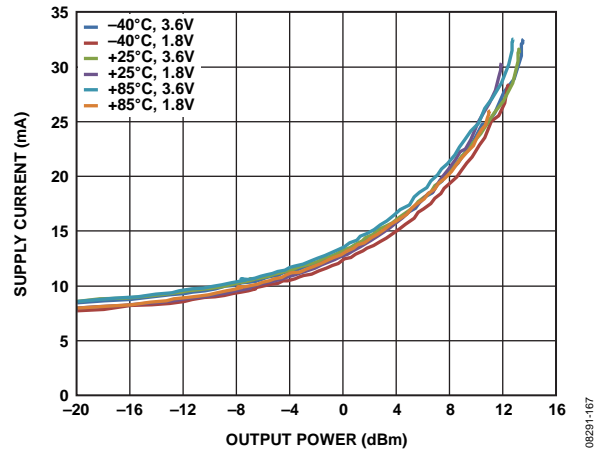

Figure 8. Single-Ended PA at 868 MHz: Supply Current vs. Output Power, Temperature, and  $V_{DD}$

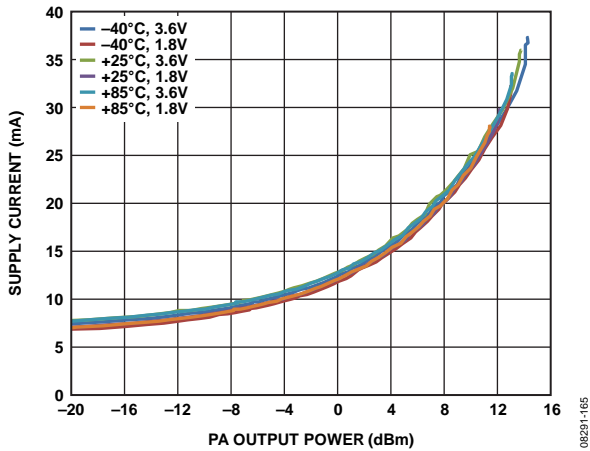

Figure 6. Single-Ended PA at 433 MHz: Supply Current vs. Output Power, Temperature, and  $V_{DD}$  (Minimum Recommended  $V_{DD} = 2.2$  V, 1.8 V Operation Shown for Robustness)

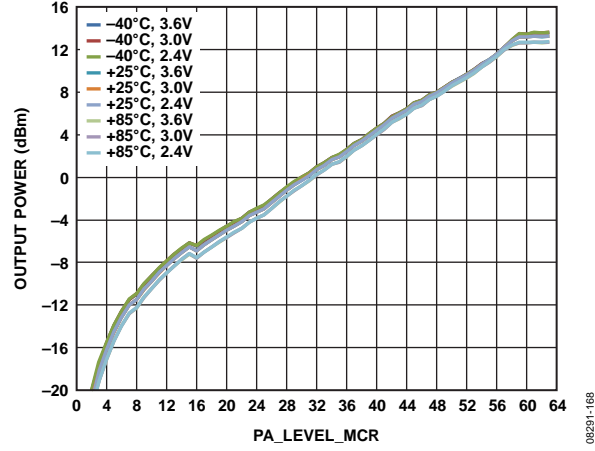

Figure 9. Single-Ended PA at 915 MHz: Output Power vs. PA\_LEVEL\_MCR Setting, Temperature, and  $V_{DD}$

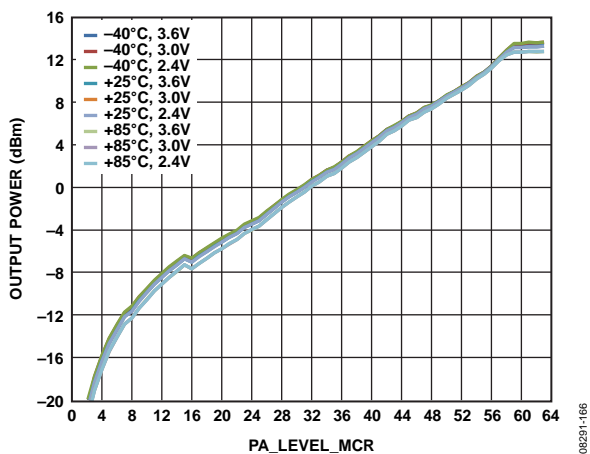

Figure 7. Single-Ended PA at 868 MHz: Output Power vs. PA\_LEVEL\_MCR Setting, Temperature, and  $V_{DD}$

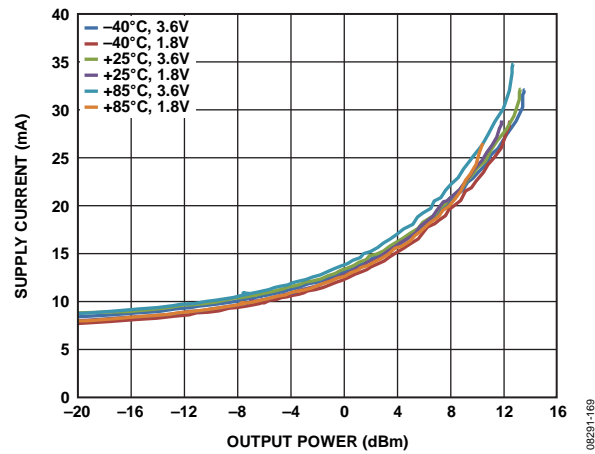

Figure 10. Single-Ended PA at 915 MHz: Supply Current vs. Output Power, Temperature, and  $V_{DD}$  (Minimum Recommended  $V_{DD} = 2.2$  V, 1.8 V Operation Shown for Robustness)

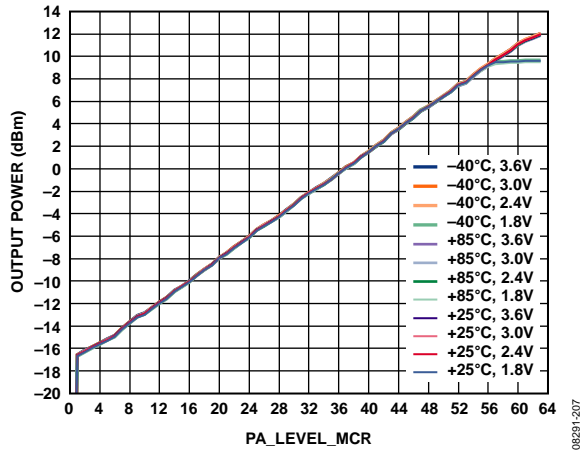

Figure 11. Differential PA at 433 MHz: Output Power vs. PA\_LEVEL\_MCR Setting, Temperature, and V<sub>DD</sub> (Minimum Recommended V<sub>DD</sub> = 2.2 V, 1.8 V Operation Shown for Robustness)

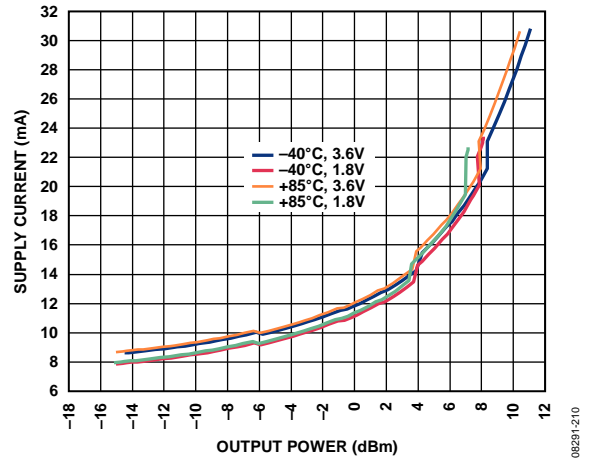

Figure 14. Differential PA at 915 MHz: Supply Current vs. Output Power, Temperature, and V<sub>DD</sub> (Minimum Recommended V<sub>DD</sub> = 2.2 V, 1.8 V Operation Shown for Robustness)

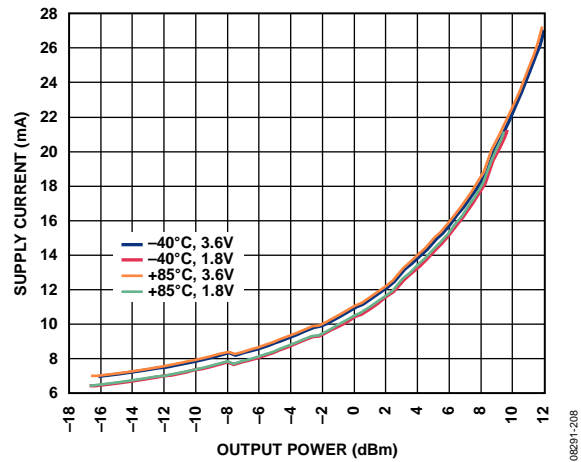

Figure 12. Differential PA at 433 MHz: Supply Current vs. Output Power, Temperature, and V<sub>DD</sub> (Minimum Recommended V<sub>DD</sub> = 2.2 V, 1.8 V Operation Shown for Robustness)

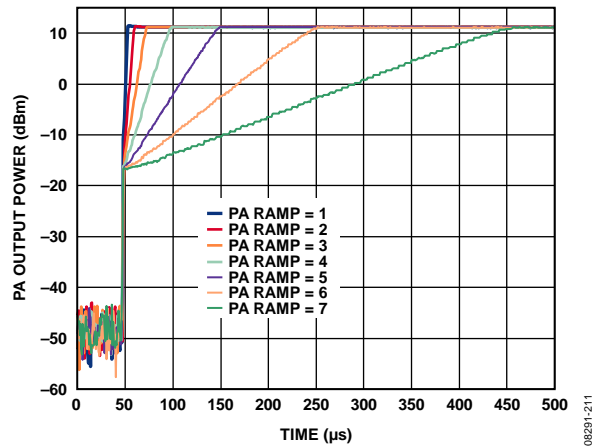

Figure 15. PA Ramp-Up at Data Rate = 38.4 kbps for Each PA\_RAMP Setting, Differential PA

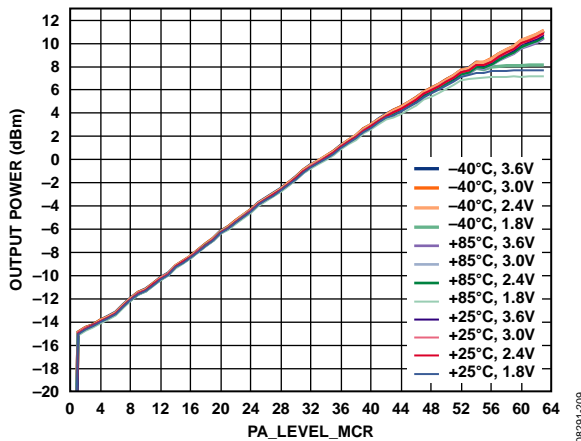

Figure 13. Differential PA at 915 MHz: Output Power vs. PA\_LEVEL\_MCR Setting, Temperature, and V<sub>DD</sub> (Minimum Recommended V<sub>DD</sub> = 2.2 V, 1.8 V Operation Shown for Robustness)

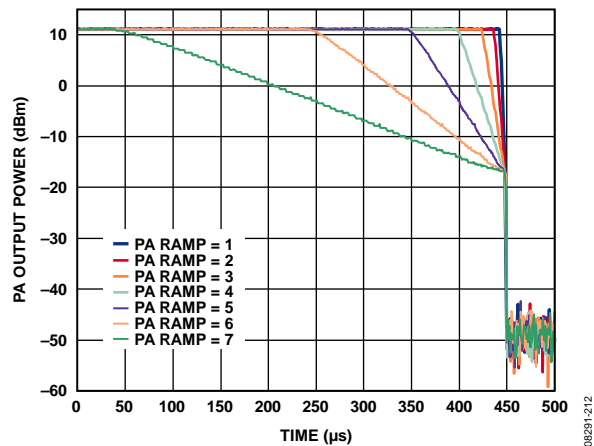

Figure 16. PA Ramp-Down at Data Rate = 38.4 kbps for Each PA\_RAMP Setting, Differential PA



Figure 17. PA Ramp-Up at Data Rate = 300 kbps for Each PA\_RAMP Setting, Differential PA



Figure 20. Transmit Spectrum at 868 MHz, GFSK, Data Rate = 38.4 kbps, Frequency Deviation = 20 kHz (Minimum Recommended  $V_{DD} = 2.2 V$ , 1.8 V Operation Shown for Robustness)

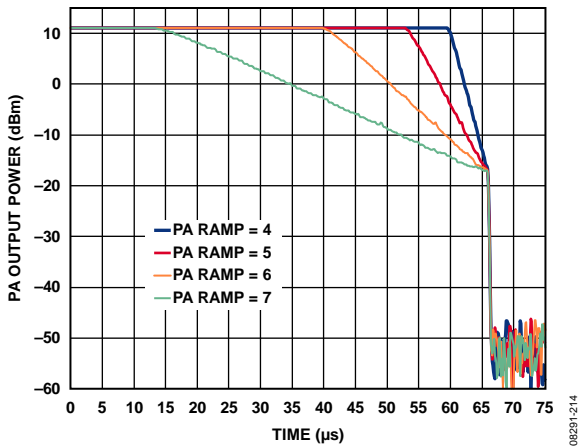

Figure 18. PA Ramp-Down at Data Rate = 300 kbps for Each PA\_RAMP Setting, Differential PA



Figure 21. Transmit Spectrum at 928 MHz, GFSK, Data Rate = 300 kbps, Frequency Deviation = 75 kHz (Minimum Recommended  $V_{DD} = 2.2 V$ , 1.8 V Operation Shown for Robustness)

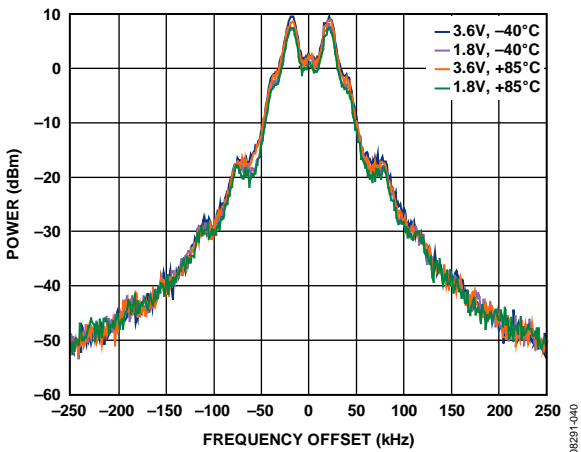

Figure 19. Transmit Spectrum at 868 MHz, FSK, Data Rate = 38.4 kbps, Frequency Deviation = 20 kHz (Minimum Recommended  $V_{DD} = 2.2 V$ , 1.8 V Operation Shown for Robustness)



Figure 22. Transmit Eye at 868 MHz, GFSK, Data Rate = 38.4 kbps, Frequency Deviation = 21 kHz

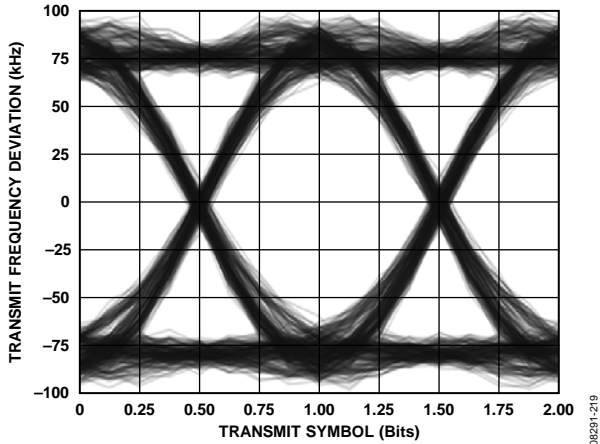

Figure 23. Transmitt Eye at 868 MHz, GFSK, Data Rate = 300 kbps, Frequency Deviation = 75 kHz

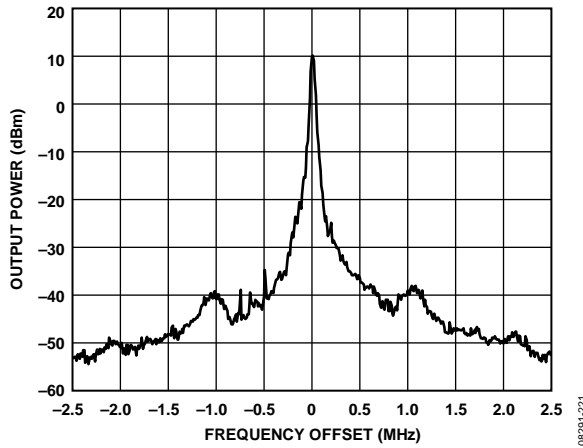

Figure 24. OOK Transmitt Spectrum, Max Hold for 100 Sweeps, Single-Ended PA, 868.95 MHz, Data Rate = 16.4 kbps (32.8 kcps, Manchester Encoded), PA\_RAMP = 1

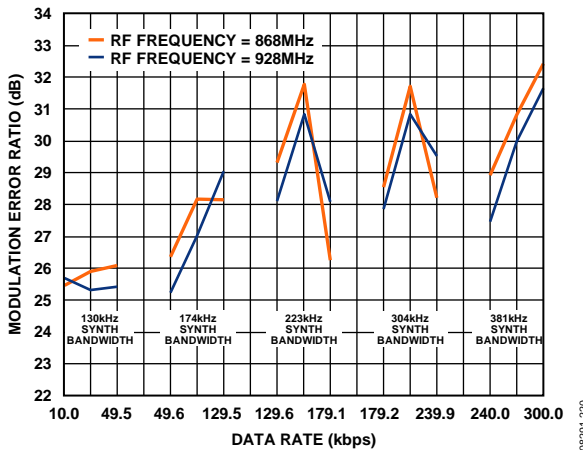

Figure 25. Modulation Error Ratio (MER) vs. Data Rate, Synthesizer Loop Bandwidth, and RF Frequency at Modulation Index = 1

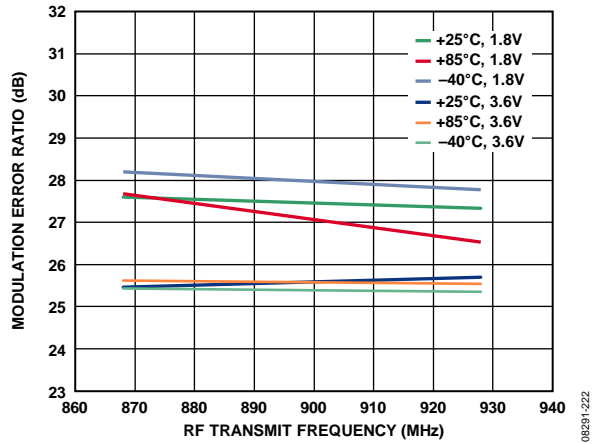

Figure 26. Modulation Error Ratio (MER) vs. RF Frequency, Temperature, and  $V_{DD}$  at Modulation Index = 1 and Data Rate = 10 kbps (Minimum Recommended  $V_{DD}$  = 2.2 V, 1.8 V Operation Shown for Robustness)

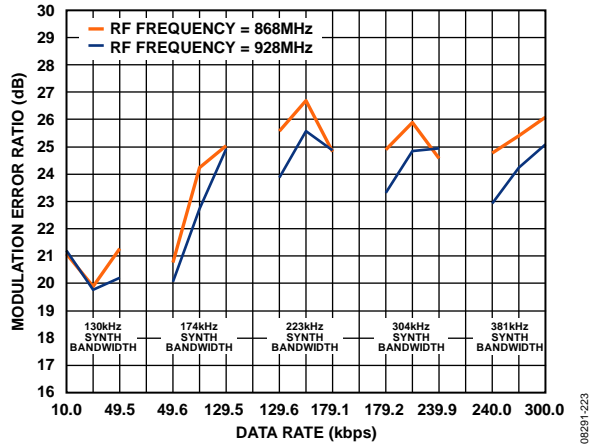

Figure 27. Modulation Error Ratio (MER) vs. Data Rate, Synthesizer Loop Bandwidth, and RF Frequency at Modulation Index = 0.5

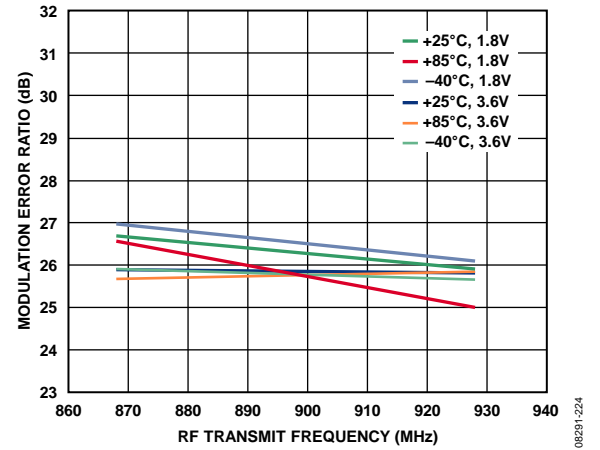

Figure 28. Modulation Error Ratio (MER) vs. RF Frequency, Temperature, and  $V_{DD}$  at Modulation Index = 0.5 and Data Rate = 10 kbps



Figure 29. LNA/Mixer 1 dB Compression Point,  $V_{DD} = 3.0\text{ V}$ , Temperature =  $25^\circ\text{C}$ , RF Frequency = 915 MHz, LNA Gain = Low, Mixer Gain = Low



Figure 32. LNA/Mixer IIP3,  $V_{DD} = 3.0\text{ V}$ , Temperature =  $25^\circ\text{C}$ , RF Frequency = 915 MHz, LNA Gain = High, Mixer Gain = High, Source 1 Frequency = (915 + 0.4) MHz, Source 2 Frequency = (915 + 0.7) MHz



Figure 30. LNA/Mixer 1 dB Compression Point,  $V_{DD} = 3.0\text{ V}$ , Temperature =  $25^\circ\text{C}$ , RF Frequency = 915 MHz, LNA Gain = High, Mixer Gain = High



Figure 33. IF Filter Profile vs. IF Bandwidth,  $V_{DD} = 3.0\text{ V}$ , Temperature =  $25^\circ\text{C}$

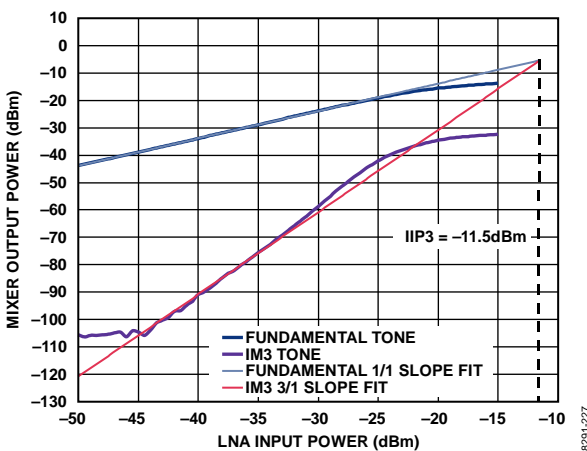

Figure 31. LNA/Mixer IIP3,  $V_{DD} = 3.0\text{ V}$ , Temperature =  $25^\circ\text{C}$ , RF Frequency = 915 MHz, LNA Gain = Low, Mixer Gain = Low, Source 1 Frequency = (915 + 0.4) MHz, Source 2 Frequency = (915 + 0.7) MHz



Figure 34. IF Filter Profile vs.  $V_{DD}$  and Temperature, 100 kHz IF Filter Bandwidth (Minimum Recommended  $V_{DD} = 2.2\text{ V}$ , 1.8 V Operation Shown for Robustness)





Figure 35. Receiver Wideband Blocking at 433 MHz, Data Rate = 38.4 kbps

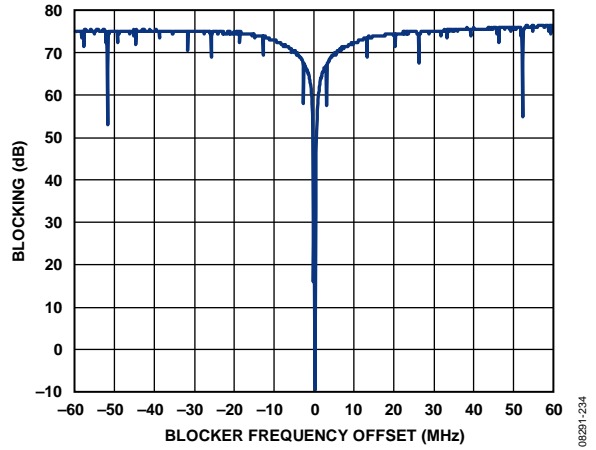

Figure 38. Receiver Wideband Blocking to  $\pm 60$  MHz, at 868 MHz, Data Rate = 38.4 kbps, Carrier Wave Interferer



Figure 36. Receiver Wideband Blocking at 433 MHz, Data Rate = 100 kbps



Figure 39. Receiver Wideband Blocking at 868 MHz, Data Rate = 100 kbps



Figure 37. Receiver Wideband Blocking at 433 MHz, Data Rate = 300 kbps



Figure 40. Receiver Wideband Blocking at 868 MHz, Data Rate = 300 kbps

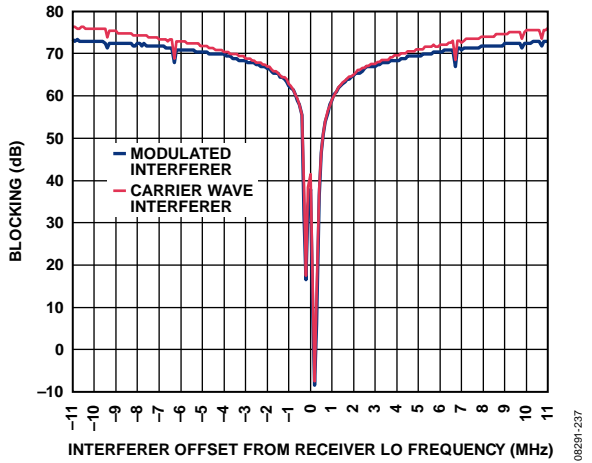

Figure 41. Receiver Wideband Blocking at 915 MHz, Data Rate = 38.4 kbps



Figure 44. Receiver Wideband Blocking vs.  $V_{DD}$  and Temperature, 915 MHz, Data Rate = 300 kbps

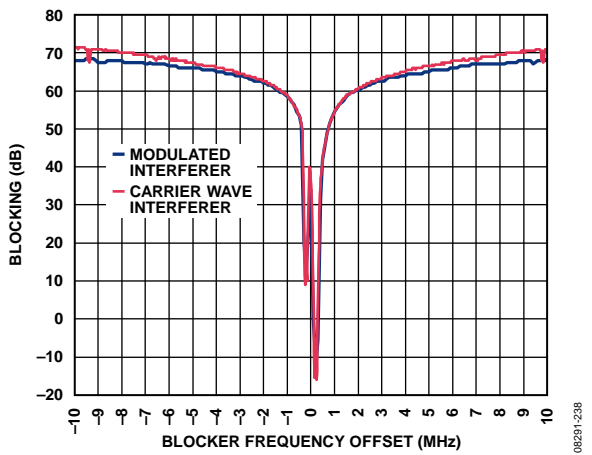

Figure 42. Receiver Wideband Blocking at 915 MHz, Data Rate = 100 kbps

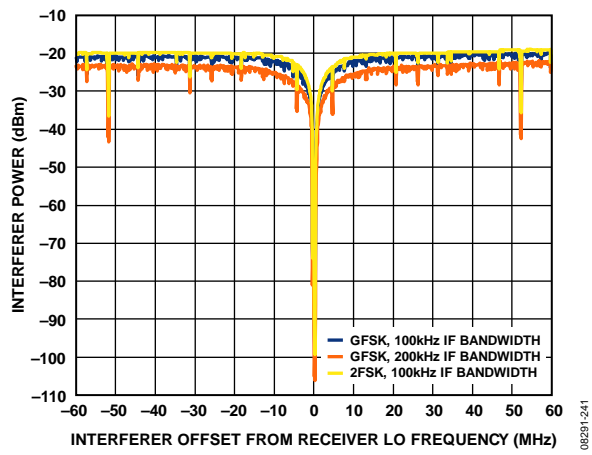

Figure 45. Receiver Wideband Blocking at 868 MHz, Data Rate = 38.4 kbps, Measured as per ETSI EN 300 220

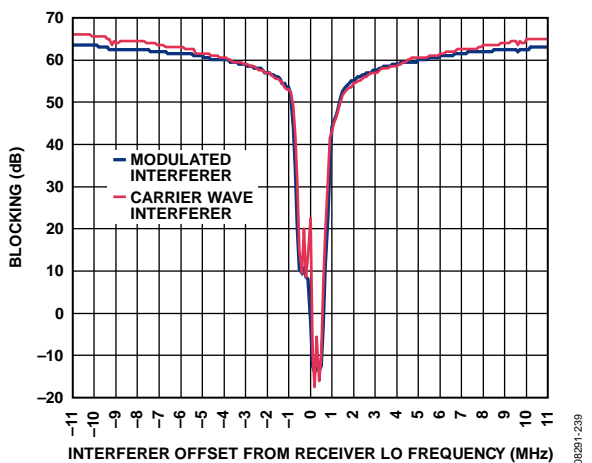

Figure 43. Receiver Wideband Blocking at 915 MHz, Data Rate = 300 kbps

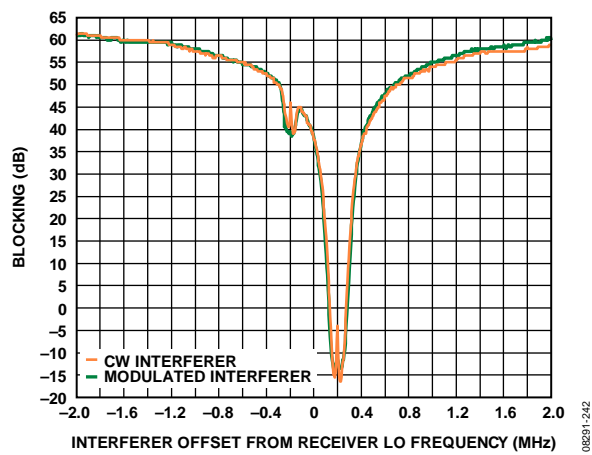

Figure 46. Receiver Close-In Blocking at 915 MHz, Data Rate = 50 kbps, IF Filter Bandwidth = 100 kHz, Image Calibrated

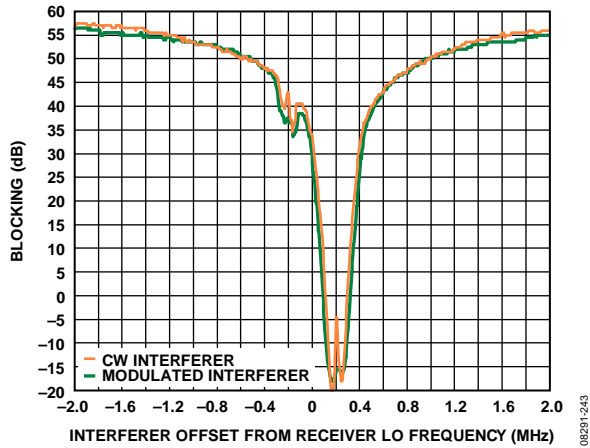

Figure 47. Receiver Close-In Blocking at 915 MHz, Data Rate = 100 kbps, IF Filter Bandwidth = 100 kHz, Image Calibrated

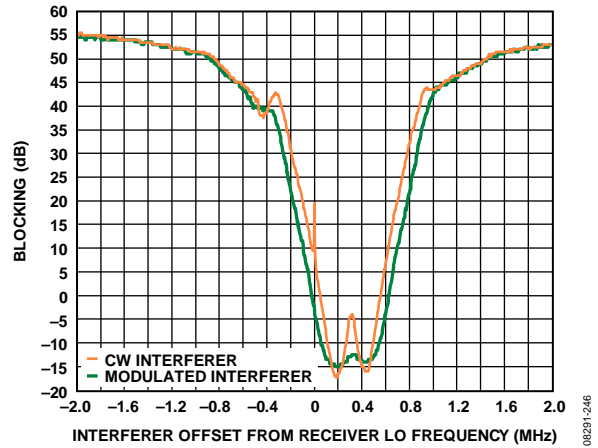

Figure 50. Receiver Close-In Blocking at 915 MHz, Data Rate = 300 kbps, IF Filter Bandwidth = 300 kHz, Image Calibrated

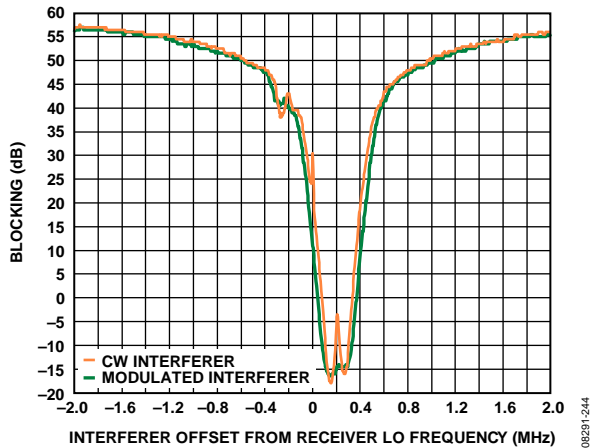

Figure 48. Receiver Close-In Blocking at 915 MHz, Data Rate = 150 kbps, IF Filter Bandwidth = 150 kHz, Image Calibrated

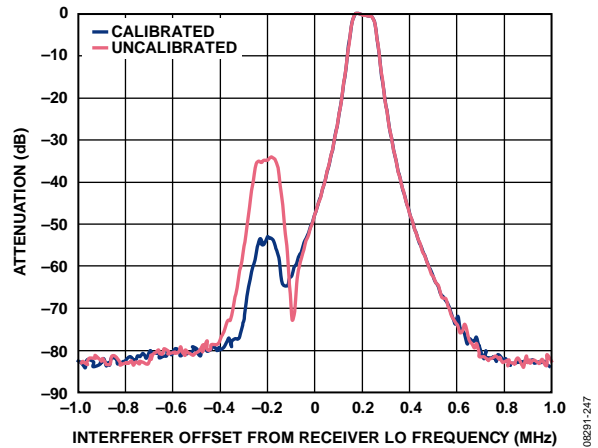

Figure 51. Image Attenuation with Calibrated and Uncalibrated Images, 915 MHz, IF Filter Bandwidth = 100 kHz,  $V_{DD} = 3.0$  V, Temperature = 25°C

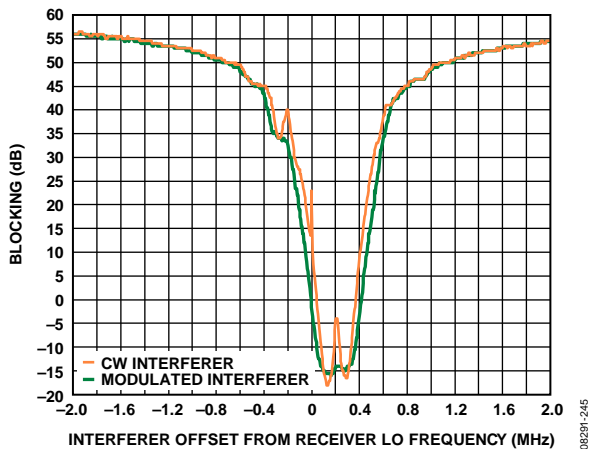

Figure 49. Receiver Close-In Blocking at 915 MHz, Data Rate = 200 kbps, IF Filter Bandwidth = 200 kHz, Image Calibrated

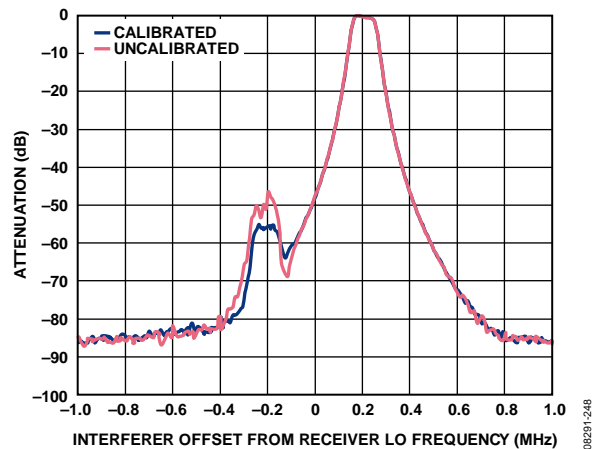

Figure 52. Image Attenuation with Calibrated and Uncalibrated Images, 433 MHz, IF Filter Bandwidth = 100 kHz,  $V_{DD} = 3.0$  V, Temperature = 25°C



Figure 53. IF Filter Profile with Calibrated Image vs. IF Filter Bandwidth, 921 MHz,  $V_{DD} = 3.0$  V, Temperature = 25°C



Figure 56. Packet Error Rate vs. RF Input Power and Data Rate, FSK/GFSK, 928 MHz, Preamble Length = 64 Bits,  $V_{DD} = 3.0$  V, Temperature = 25°C

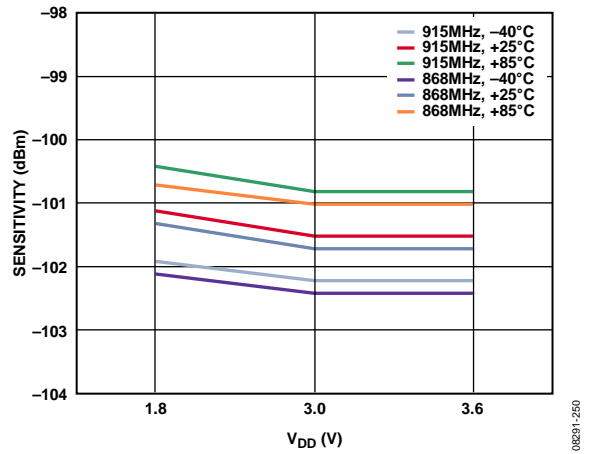

Figure 54. Receiver Sensitivity (Bit Error Rate at  $1E-3$ ) vs.  $V_{DD}$ , Temperature, and RF Frequency, Data Rate = 300 kbps, GFSK, Frequency Deviation = 75 kHz, IF Bandwidth = 300 kHz

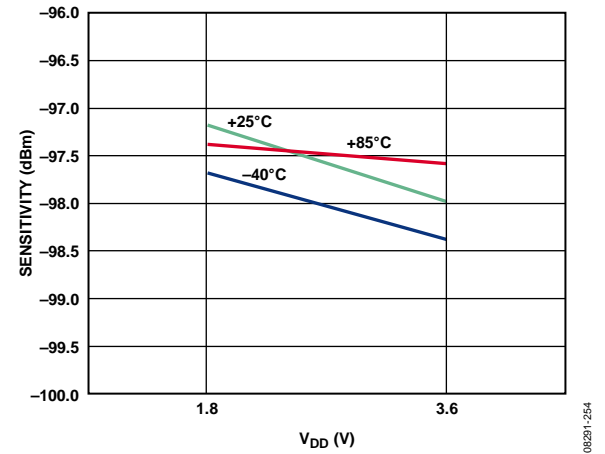

Figure 57. Receiver Sensitivity (Packet Error Rate at 1%) vs.  $V_{DD}$ , Temperature, and RF Frequency, Data Rate = 300 kbps, GFSK, Frequency Deviation = 75 kHz, IF Bandwidth = 300 kHz

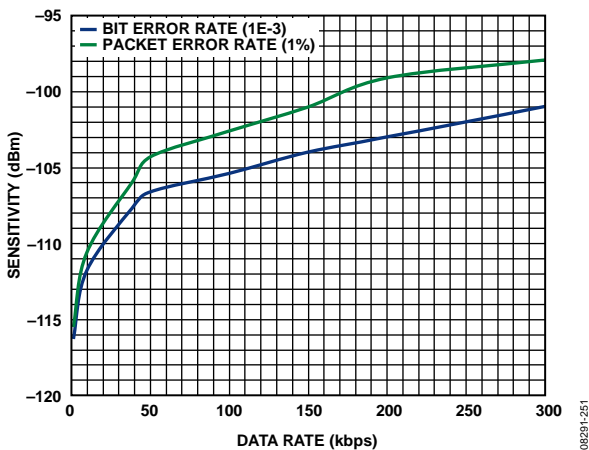

Figure 55. Bit Error Rate Sensitivity (at  $BER = 1E-3$ ) and Packet Error Rate Sensitivity (at  $PER = 1\%$ ) vs. Data Rate, GFSK,  $V_{DD} = 3.0$  V, Temperature = 25°C

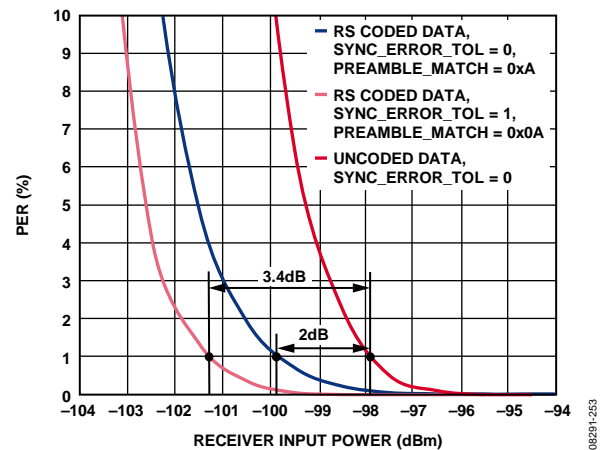

Figure 58. Receiver PER Using Reed Solomon (RS) Coding; RF Frequency = 915 MHz, GFSK, Data Rate = 300 kbps, Frequency Deviation = 75 kHz, Packet Length = 28 Bytes (Uncoded); Reed Solomon Configuration:  $n = 38$ ,  $k = 28$ ,  $t = 5$

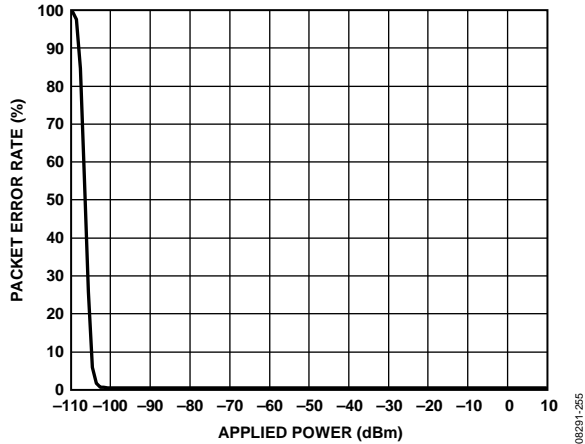

Figure 59. OOK Packet Error Rate vs. RF Input Power, Data Rate = 19.2 kbps (Chip Rate = 38.4 kcps, Manchester Encoded), IF Bandwidth = 100 kHz,  $V_{DD}$  = 3.6 V, Temperature = 25°C, RF Frequency = 902 MHz, Preamble Length = 100 Bits

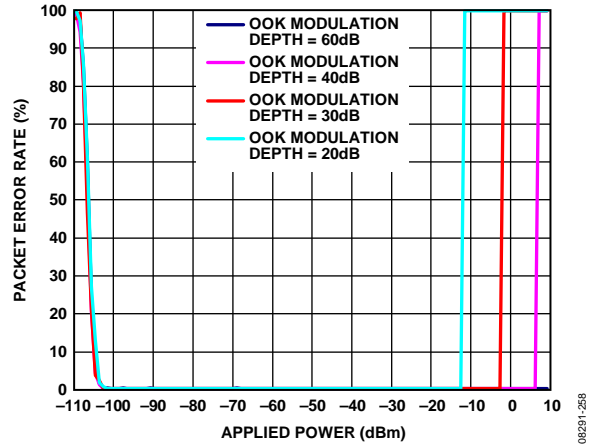

Figure 62. OOK Packet Error Rate vs. RF Input Power and OOK Modulation Depth, Data Rate = 19.2 kbps (Chip Rate = 38.4 kcps, Manchester Encoded), IF Bandwidth = 100 kHz,  $V_{DD}$  = 3.6 V, Temperature = 25°C, RF Frequency = 902 MHz, Preamble Length = 100 Bits

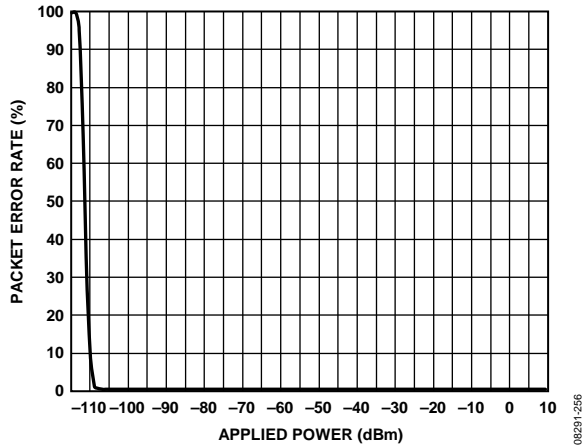

Figure 60. OOK Packet Error Rate vs. RF Input Power, Data Rate = 2.4 kbps (Chip Rate = 4.8 kcps, Manchester Encoded), IF Bandwidth = 100 kHz,  $V_{DD}$  = 3.6 V, Temperature = 25°C, RF Frequency = 902 MHz, Preamble Length = 100 Bits

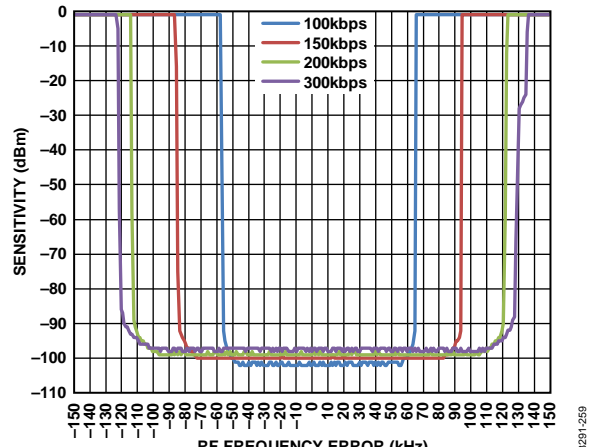

Figure 63. AFC On: Receiver Sensitivity (at PER = 1%) vs. RF Frequency Error, GFSK, 915 MHz, AFC Enabled ( $K_i = 7$ ,  $K_p = 3$ ), AFC Mode = Lock After Preamble, IF Bandwidth = 100 kHz (at 100 kbps), 150 kHz (at 150 kbps), 200 kHz (at 200 kbps), and 300 kHz (at 300 kbps), Preamble Length = 64 Bits



Figure 61. OOK Packet Error Rate vs. RF Input Power,  $V_{DD}$  and Temperature, Data Rate = 19.2 kbps (Chip Rate = 38.4 kcps, Manchester Encoded), IF Bandwidth = 100 kHz,  $V_{DD}$  = 3.6 V, Temperature = 25°C, RF Frequency = 902 MHz, Preamble Length = 100 Bits (Minimum Recommended  $V_{DD}$  = 2.2 V, 1.8 V Operation Shown for Robustness)



Figure 64. AFC Off: Packet Error Rate vs. RF Frequency Error and Data Rate Error, Data Rate = 300 kbps, Frequency Deviation = 75 kHz, GFSK,  $AGC\_LOCK\_MODE$  = Lock After Preamble

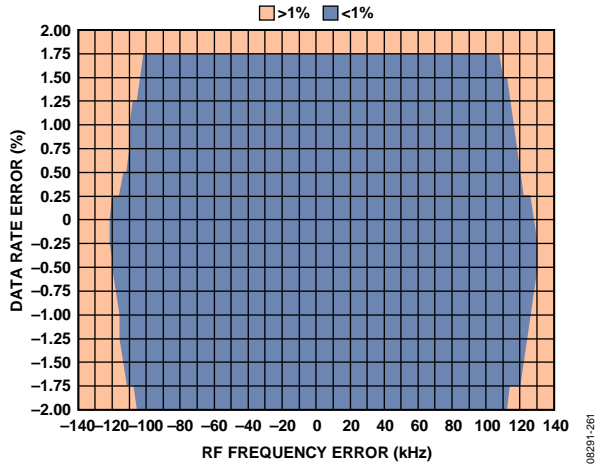

Figure 65. AFC On: Packet Error Rate vs. RF Frequency Error and Data Rate Error, Data Rate = 300 kbps, Frequency Deviation = 75 kHz, GFSK, AGC\_LOCK\_MODE = Lock After Preamble

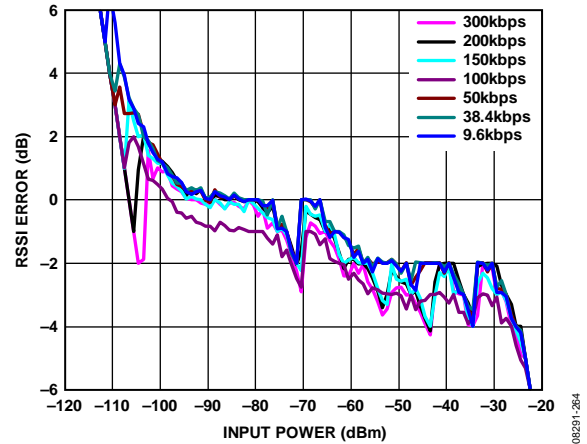

Figure 68. Mean RSSI Error (via Automatic End of Packet RSSI Measurement) vs. RF Input Power vs. Data Rate; RF Frequency = 868 MHz, GFSK, 100 RSSI Measurements at Each Input Power Level

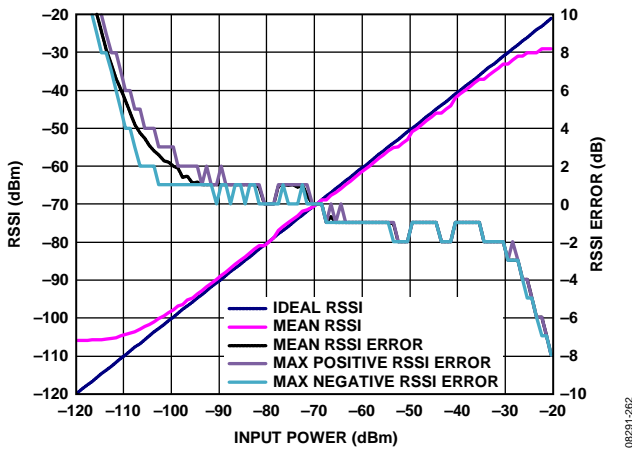

Figure 66. RSSI (via CMD\_GET\_RSSI) vs. RF Input Power, 868 MHz, GFSK, Data Rate = 38.4 kbps, Frequency Deviation = 20 kHz, IF Bandwidth = 100 kHz, 100 RSSI Measurements at Each Input Power Level

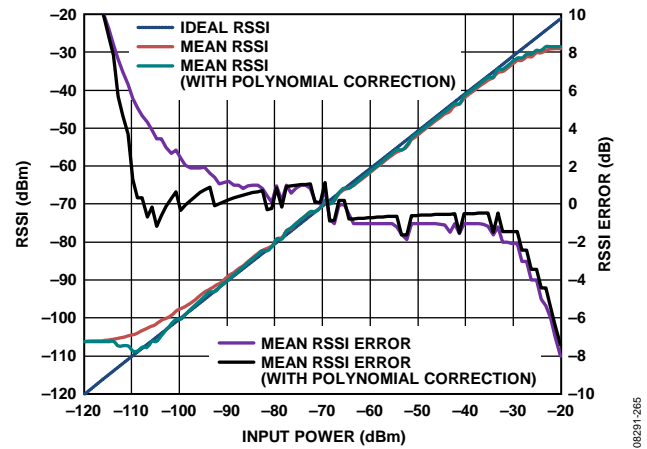

Figure 69. RSSI With and Without Cosine Polynomial Correction (via Automatic End of Packet RSSI Measurement), 100 RSSI Measurements at Each Input Power Level

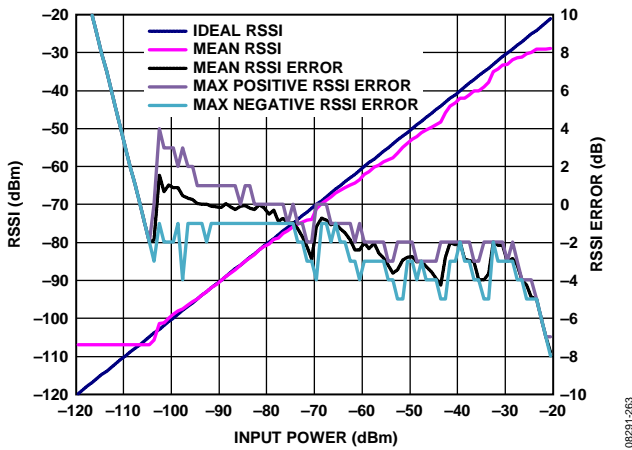

Figure 67. RSSI (via Automatic End of Packet RSSI Measurement) vs. RF Input Power, 868 MHz, GFSK, Data Rate = 300 kbps, Frequency Deviation = 75 kHz, IF Bandwidth = 300 kHz, AGC\_CLOCK\_DIVIDE = 15, 100 RSSI Measurements at Each Input Power Level

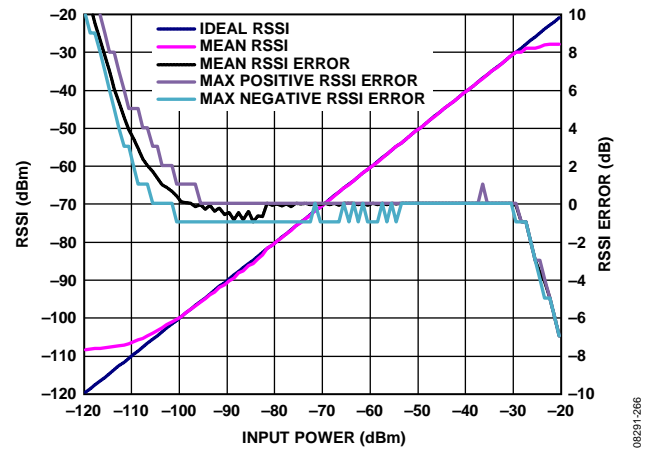

Figure 70. OOK RSSI and OOK RSSI Error vs. RF Input Power. 915 MHz, Data Rate = 19.2 kbps (38.4 kcps), 200 RSSI Measurements per Input Power Level



Figure 71. OOK RSSI vs. RF Input Power,  $V_{DD}$ , and Temperature, RF Frequency = 915 MHz, Data Rate = 19.2 kbps (38.4 kcps Manchester Encoded)

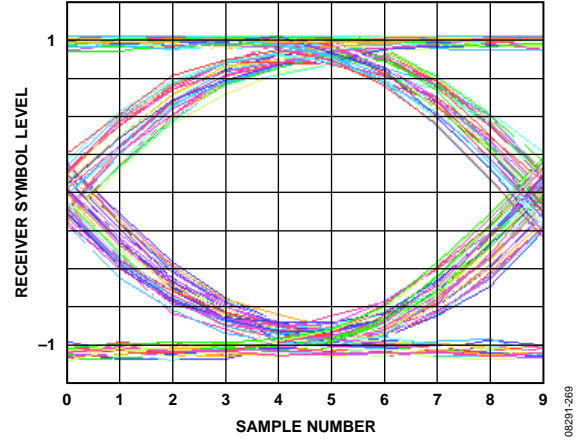

Figure 73. Receiver Eye Diagram Measured Using the Test DAC, RF Frequency = 915 MHz, RF Input Power = -80 dBm, Data Rate = 100 kbps, Frequency Deviation = 50 kHz

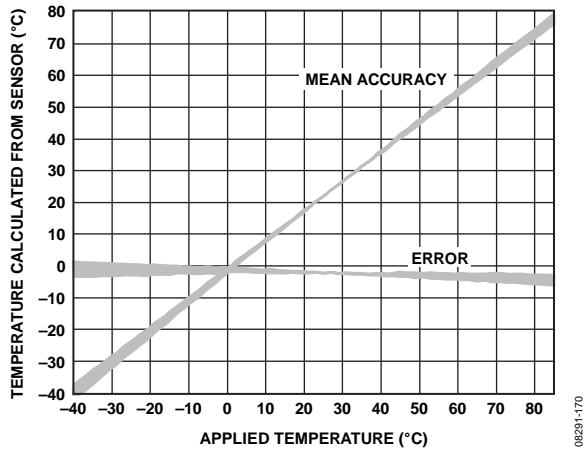

Figure 72. Typical Accuracy Range of Temperature Sensor vs. Applied Temperature, Calibration Performed at 25°C



Figure 74. Receiver Eye Diagram Measured Using the Test DAC, RF Frequency = 915 MHz, RF Input Power = -105 dBm, Data Rate = 100 kbps, Frequency Deviation = 50 kHz

**TERMINOLOGY****ADC**

Analog to digital converter

**AGC**

Automatic gain control

**AFC**

Automatic frequency control

**Battmon**

Battery monitor

**BBRAM**

Battery backup random access memory

**CBC**

Cipher block chaining

**CRC**

Cyclic redundancy check

**DR**

Data rate

**ECB**

Electronic code book

**ECC**

Error checking code

**2FSK**

Two-level frequency shift keying

**GFSK**

Two-level Gaussian frequency shift keying

**GMSK**

Gaussian minimum shift keying

**LO**

Local oscillator

**MAC**

Media access control

**MCR**

Modem configuration random access memory

**MER**

Modulation error rate

**MSK**

Minimum shift keying

**NOP**

No operation

**OOK**

On-off keying

**PA**

Power amplifier

**PFD**

Phase frequency detector

**PHY**

Physical layer

**RCO**

RC oscillator

**RISC**

Reduced instruction set computer

**RSSI**

Receive signal strength indicator

**Rx**

Receive

**SAR**

Successive approximation register

**SWM**

Smart wake mode

**Tx**

Transmit

**VCO**

Voltage controlled oscillator

**WUC**

Wake-up controller

**XOSC**

Crystal oscillator



## RADIO CONTROL

The ADF7023 has five radio states designated PHY\_SLEEP, PHY\_OFF, PHY\_ON, PHY\_RX, and PHY\_TX. The host processor can transition the ADF7023 between states by issuing single byte commands over the SPI interface. The various commands and states are illustrated in Figure 75. The communications processor handles the sequencing of various radio circuits and critical timing functions, thereby simplifying radio operation and easing the burden on the host processor.

### RADIO STATES

#### PHY\_SLEEP

In this state, the device is in a low power sleep mode. To enter the state, issue the CMD\_PHY\_SLEEP command, either from the PHY\_OFF or PHY\_ON state. To wake the radio from the state, set the CS pin low, or use the wake-up controller (32.768 kHz RC or 32.768 kHz crystal) to wake the radio from this state. The wake-up timer should be set up before entering the PHY\_SLEEP state. If retention of BBRAM contents is not required, Deep Sleep Mode 2 can be used to further reduce the PHY\_SLEEP state current consumption. Deep Sleep Mode 2 is entered by issuing the CMD\_HW\_RESET command. The options for the PHY\_SLEEP state are detailed in Table 10. When in PHY\_SLEEP, the IRQ\_GP3 interrupt pin is held at logic low while the other GPx pins are in a high impedance state.

#### PHY\_OFF

In the PHY\_OFF state, the 26 MHz crystal, the digital regulator, and the synthesizer regulator are powered up. All memories are fully accessible. The BBRAM registers must be valid before exiting this state.

#### PHY\_ON

In the PHY\_ON state, along with the crystal, the digital regulator and the synthesizer regulator, VCO, and RF regulators are powered up. A baseband filter calibration is performed when this state is entered from the PHY\_OFF state if the BB\_CAL bit in the MODE\_CONTROL register (Address 0x11A) is set. The device is ready to operate, and the PHY\_TX and PHY\_RX states can be entered.

#### PHY\_TX

In the PHY\_TX state, the synthesizer is enabled and calibrated. The power amplifier is enabled, and the device transmits at the channel frequency defined by the CHANNEL\_FREQ[23:0] setting (Address 0x109 to Address 0x10B). The state is entered by issuing

the CMD\_PHY\_TX command. The device automatically transmits the transmit packet stored in the packet RAM. After transmission of the packet, the PA is disabled and the device automatically returns to the PHY\_ON state and can, optionally, generate an interrupt.

In sport mode, the device transmits the data present on the GP2 pin as described in the Sport section. The host processor must issue the CMD\_PHY\_ON command to exit the PHY\_TX state when in sport mode.

#### PHY\_RX

In the PHY\_RX state, the synthesizer is enabled and calibrated. The ADC, RSSI, IF filter, mixer, and LNA are enabled. The radio is in receive mode on the channel frequency defined by the CHANNEL\_FREQ[23:0] setting (Address 0x109 to Address 0x10B).

After reception of a valid packet, the device returns to the PHY\_ON state and can, optionally, generate an interrupt. In sport mode, the device remains in the PHY\_RX state until the CMD\_PHY\_ON command is issued.

### Current Consumption

The typical current consumption in each state is detailed in Table 10.

**Table 10. Current Consumption in ADF7023 Radio States**

State	Current (Typical)	Conditions
PHY_SLEEP (Deep Sleep Mode 2)	0.18 $\mu$ A	Wake-up timer off, BBRAM contents not retained, entered by issuing CMD_HW_RESET
PHY_SLEEP (Deep Sleep Mode 1)	0.33 $\mu$ A	Wake-up timer off, BBRAM contents retained
PHY_SLEEP (RCO Mode)	0.75 $\mu$ A	Wake-up timer on using a 32 kHz RC oscillator, BBRAM contents retained
PHY_SLEEP (XTO Mode)	1.28 $\mu$ A	Wake-up timer on using a 32 kHz XTAL oscillator, BBRAM contents retained
PHY_OFF	1.0 mA	
PHY_ON	1.0 mA	
PHY_TX	24.1 mA	10 dBm, single-ended PA, 868 MHz
PHY_RX	12.8 mA	



<sup>1</sup>TRANSMIT AND RECEIVE AUTOMATIC TURNAROUND MUST BE ENABLED BY BITS RX\_TO\_TX\_AUTO\_TURNAROUND AND TX\_TO\_RX\_AUTO\_TURNAROUND (0x11A: MODE\_CONTROL).  
<sup>2</sup>AES ENCRYPTION/DECRYPTION, IMAGE REJECTION CALIBRATION, AND REED SOLOMON CODING ARE AVAILABLE ONLY IF THE NECESSARY FIRMWARE MODULE HAS BEEN DOWNLOADED TO THE PROGRAM RAM.  
<sup>3</sup>THE END OF FRAME (EOF) AUTOMATIC TRANSITIONS ARE DISABLED IN SPORT MODE.  
<sup>4</sup>CMD\_AES REFERS TO THE THREE AVAILABLE AES COMMANDS: CMD\_AES\_ENCRYPT, CMD\_AES\_DECRYPT, AND CMD\_AES\_DECRYPT\_INIT.  
<sup>5</sup>CMD\_RS REFERS TO THE THREE AVAILABLE REED SOLOMON COMMANDS: CMD\_RS\_ENCODE\_INIT, CMD\_RS\_ENCODE, AND CMD\_RS\_DECODE.



Figure 75. Radio State Diagram

08251-121

## INITIALIZATION

### Initialization After Application of Power

When power is applied to the ADF7023 (through the VDDBAT1/ VDDBAT2 pins), it registers a power-on reset event (POR) and transitions to the PHY\_OFF state. The BBRAM memory is unknown, the packet RAM memory is cleared to 0x00, and the MCR memory is reset to its default values. The host processor should use the following procedure to complete the initialization sequence:

1. Bring the  $\overline{\text{CS}}$  pin of the SPI low and wait until the MISO output goes high.
2. Poll status word and wait for the CMD\_READY bit to go high.
3. Configure the part by writing to all 64 of the BBRAM registers.
4. Issue the CMD\_CONFIG\_DEV command so that the radio settings are updated using the BBRAM values.

The ADF7023 is now configured in the PHY\_OFF state.

### Initialization After Issuing the CMD\_HW\_RESET Command

The CMD\_HW\_RESET command performs a full power-down of all hardware, and the device enters the PHY\_SLEEP state. To complete the hardware reset, the host processor should complete the following procedure:

1. Wait for 1 ms.
2. Bring the  $\overline{\text{CS}}$  pin of the SPI low and wait until the MISO output goes high. The ADF7023 registers a POR and enters the PHY\_OFF state.
3. Poll status word and wait for the CMD\_READY bit to go high.
4. Configure the part by writing to all 64 of the BBRAM registers.
5. Issue the CMD\_CONFIG\_DEV command so that the radio settings are updated using the BBRAM values.

The ADF7023 is now configured in the PHY\_OFF state.

### Initialization on Transitioning from PHY\_SLEEP (After $\overline{\text{CS}}$ Is Brought Low)

The host processor can bring  $\overline{\text{CS}}$  low at any time to wake the ADF7023 from the PHY\_SLEEP state. This event is not registered as a POR event because the BBRAM contents are valid. The following is the procedure that the host processor is required to follow:

1. Bring the  $\overline{\text{CS}}$  line of the SPI low and wait until the MISO output goes high. The ADF7023 enters the PHY\_OFF state.
2. Poll status word and wait for the CMD\_READY bit to go high.
3. Issue the CMD\_CONFIG\_DEV command so that the radio settings are updated using the BBRAM values.

The ADF7023 is now configured and ready to transition to the PHY\_ON state.

### Initialization After a WUC Timeout

The ADF7023 can autonomously wake from the PHY\_SLEEP state using the wake-up controller. If the ADF7023 wakes after a WUC timeout in smart wake mode (SWM), it follows the SWM routine based on the smart wake mode configuration in BBRAM (see the Low Power Modes section). If the ADF7023 wakes after a WUC timeout with SWM disabled and the firmware timer disabled, it wakes in the PHY\_OFF state, and the following is the procedure that the host processor is required to follow:

1. Poll status word and wait for the CMD\_READY bit to go high.
2. Issue the CMD\_CONFIG\_DEV command so that the radio settings are updated using the BBRAM values.

The ADF7023 is now configured in the PHY\_OFF state.

## COMMANDS

The commands that are supported by the radio controller are detailed in this section. They initiate transitions between radio states or perform tasks as indicated in Figure 75.

### CMD\_PHY\_OFF (0xB0)

This command transitions the ADF7023 to the PHY\_OFF state. It can be issued in the PHY\_ON state. It powers down the RF and VCO regulators.

### CMD\_PHY\_ON (0xB1)

This command transitions the ADF7023 to the PHY\_ON state.

If the command is issued in the PHY\_OFF state, it powers up the RF and VCO regulators and performs an IF filter calibration if the BB\_CAL bit is set in the MODE\_CONTROL register (Address 0x11A).

If the command is issued from the PHY\_TX state, the host processor performs the following procedure:

1. Ramp down the PA.
2. Set the external PA signal low (if enabled).
3. Turn off the digital transmit clocks.
4. Power down the synthesizer.
5. Set FW\_STATE = PHY\_ON.

If the command is issued from the PHY\_RX state, the communications processor performs the following procedure:

1. Copy the measured RSSI to the RSSI\_READBACK register.
2. Set the external LNA signal low (if enabled).
3. Turn off the digital receiver clocks.
4. Power down the synthesizer and the receiver circuitry (ADC, RSSI, IF filter, mixer, and LNA).
5. Set FW\_STATE = PHY\_ON.

**CMD\_PHY\_SLEEP (0xBA)**

This command transitions the ADF7023 to the very low power PHY\_SLEEP state in which the WUC is operational (if enabled), and the BBRAM contents are retained. It can be issued from the PHY\_OFF or PHY\_ON state.

**CMD\_PHY\_RX (0xB2)**

This command can be issued in the PHY\_ON, PHY\_RX, or PHY\_TX state. If the command is issued in the PHY\_ON state, the communications processor performs the following procedure:

1. Power up the synthesizer.
2. Power up the receiver circuitry (ADC, RSSI, IF filter, mixer, and LNA).
3. Set the RF channel based on the CHANNEL\_FREQ[23:0] setting in BBRAM.
4. Set the synthesizer bandwidth.
5. Do VCO calibration.
6. Delay for synthesizer settling.
7. Enable the digital receiver blocks.
8. Set the external LNA enable signal high (if enabled).
9. Set FW\_STATE = PHY\_RX.

If the command is issued in the PHY\_RX state, the communications processor performs the following procedure:

1. Set the external LNA signal low (if enabled).
2. Unlock the AFC and AGC.
3. Turn off the receive blocks.
4. Set the RF channel based on the CHANNEL\_FREQ[23:0] setting in BBRAM.
5. Set the synthesizer bandwidth.
6. Do VCO calibration.
7. Delay for synthesizer settling.
8. Enable the digital receiver blocks.
9. Set the external LNA enable signal high (if enabled).
10. Set FW\_STATE = PHY\_RX.

If the command is issued in the PHY\_TX state, the communications processor performs the following procedure:

1. Ramp down the PA.
2. Set the external PA signal low (if enabled).
3. Turn off the digital transmit blocks.
4. Power up the receiver circuitry (ADC, RSSI, IF filter, mixer, and LNA).
5. Set the RF channel based on the CHANNEL\_FREQ[23:0] setting in BBRAM.
6. Set the synthesizer bandwidth.
7. Do VCO calibration.
8. Delay for synthesizer settling.
9. Enable the digital receiver blocks.
10. Set the external LNA enable signal high (if enabled).
11. Set FW\_STATE = PHY\_RX.

**CMD\_PHY\_TX (0xB5)**

This command can be issued in the PHY\_ON, PHY\_TX, or PHY\_RX state. If the command is issued in the PHY\_ON state, the communications processor performs the following procedure:

1. Power up the synthesizer.
2. Set the RF channel based on the CHANNEL\_FREQ[23:0] setting in BBRAM.
3. Set the synthesizer bandwidth.
4. Do VCO calibration.
5. Delay for synthesizer settling.
6. Enable the digital transmit blocks.
7. Set the external PA enable signal high (if enabled).
8. Ramp up the PA.
9. Set FW\_STATE = PHY\_TX.
10. Transmit data.

If the command is issued in the PHY\_TX state, the communications processor performs the following procedure:

1. Ramp down the PA.
2. Set the external PA enable signal low (if enabled).
3. Turn off the digital transmit blocks.
4. Set the RF channel based on the CHANNEL\_FREQ[23:0] setting in BBRAM.
5. Set the synthesizer bandwidth.
6. Do VCO calibration.
7. Delay for synthesizer settling.
8. Enable the digital transmit blocks.
9. Set the external PA enable signal high (if enabled).
10. Ramp up the PA.
11. Set FW\_STATE = PHY\_TX.
12. Transmit data.

If the command is issued in the PHY\_RX state, the communications processor performs the following procedure:

1. Set the external LNA signal low (if enabled).
2. Unlock the AFC and AGC.
3. Turn off the receive blocks.
4. Power down the receiver circuitry (ADC, RSSI, IF filter, mixer, and LNA).
5. Set the RF channel based on the CHANNEL\_FREQ[23:0] setting in BBRAM.
6. Set the synthesizer bandwidth.
7. Delay for synthesizer settling.
8. Enable the digital transmit blocks.
9. Set the external PA enable signal high (if enabled).
10. Ramp up the PA.
11. Set FW\_STATE = PHY\_TX.
12. Transmit data.

**CMD\_CONFIG\_DEV (0xBB)**

This command interprets the BBRAM contents and configures each of the radio parameters based on these contents. It can be issued from the PHY\_OFF or PHY\_ON state. The only radio parameter that isn't configured on this command is the CHANNEL\_FREQ[23:0] setting, which instead is configured as part of a CMD\_PHY\_TX or CMD\_PHY\_RX command.

The user should write to the entire 64 bytes of the BBRAM and then issue the CMD\_CONFIG\_DEV command, which can be issued in the PHY\_OFF or PHY\_ON state.

**CMD\_GET\_RSSI (0xBC)**

This command turns on the receiver, performs an RSSI measurement on the current channel, and returns the ADF7023 to the PHY\_ON state. The command can be issued from the PHY\_ON state. The RSSI result is saved to the RSSI\_READBACK register (Address 0x312). This command can be issued from the PHY\_ON state only.

**CMD\_BB\_CAL (0xBE)**

This command performs an IF filter calibration. It can be issued only in the PHY\_ON state. In many cases, it may not be necessary to use this command because an IF filter calibration is automatically performed on the PHY\_OFF to PHY\_ON transition if BB\_CAL = 1 in the MODE\_CONTROL register (Address 0x11A).

**CMD\_HW\_RESET (0xC8)**

The command performs a full power-down of all hardware, and the device enters the PHY\_SLEEP state. This command can be issued in any state and is independent of the state of the communications processor. The procedure for initialization of the device after a CMD\_HW\_RESET command is described in detail in the Initialization section.

**CMD\_RAM\_LOAD\_INIT (0xBF)**

This command prepares the communications processor for a subsequent download of a software module to program RAM. This command should be issued only prior to the program RAM being written to by the host processor.

**CMD\_RAM\_LOAD\_DONE (0xC7)**

This command is required only after download of a software module to program RAM. It indicates to the communications processor that a software module is loaded to program RAM. The CMD\_RAM\_LOAD\_DONE command can be issued only in the PHY\_OFF state. The command resets the communications processor and the packet RAM.

**CMD\_IR\_CAL (0xBD)**

This command performs a fully automatic image rejection calibration on the ADF7023 receiver.

This command requires that the IR calibration firmware module has been loaded to the ADF7023 program RAM. The firmware module is available from Analog Devices. For more information, see the Downloadable Firmware Modules section.

**CMD\_AES\_ENCRYPT (0xD0), CMD\_AES\_DECRYPT (0xD2), and CMD\_AES\_DECRYPT\_INIT (0xD1)**

These commands allow AES, 128-bit block encryption and decryption of transmit and receive data using key sizes of 128 bits, 192 bits, or 256 bits.

The AES commands require that the AES firmware module has been loaded to the ADF7023 program RAM. The AES firmware module is available from Analog Devices. See the Downloadable Firmware Modules section for details on the AES encryption and decryption module.

**CMD\_RS\_ENCODE\_INIT (0xD1), CMD\_RS\_ENCODE (0xD0), and CMD\_RS\_DECODE (0xD2)**

These commands perform Reed Solomon encoding and decoding of transmit and receive data, thereby allowing detection and correction of errors in the received packet.

These commands require that the Reed Solomon firmware module has been loaded to the ADF7023 program RAM. The Reed Solomon firmware module is available from Analog Devices. See the Downloadable Firmware Modules section for details on this module.

**AUTOMATIC STATE TRANSITIONS**

On certain events, the communications processor can automatically transition the ADF7023 between states. These automatic transitions are illustrated as dashed lines in Figure 75 and are explained in this section.

**TX\_EOF**

The communications processor automatically transitions the device from the PHY\_TX state to the PHY\_ON state at the end of a packet transmission. On the transition, the communications processor performs the following actions:

1. Ramps down the PA.
2. Sets the external PA signal low.
3. Disables the digital transmitter blocks.
4. Powers down the synthesizer.
5. Sets FW\_STATE = PHY\_ON.

**RX\_EOF**

The communications processor automatically transitions the device from the PHY\_RX state to the PHY\_ON state at the end of a packet reception. On the transition, the communications processor performs the following actions:

1. Copies the measured RSSI to the RSSI\_READBACK register (Address 0x312).
2. Sets the external LNA signal low.
3. Disables the digital receiver blocks.
4. Powers down the synthesizer and the receiver circuitry (ADC, RSSI, IF filter, mixer, and LNA).
5. Sets FW\_STATE = PHY\_ON.

**RX\_TO\_TX\_AUTO\_TURNAROUND**

If the RX\_TO\_TX\_AUTO\_TURNAROUND bit in the MODE\_CONTROL register (Address 0x11A) is enabled, the device automatically transitions to the PHY\_TX state at the end of a valid packet reception, on the same RF channel frequency. On the transition, the communications processor performs the following actions:

1. Sets the external LNA signal low.
2. Unlocks the AGC and AFC (if enabled).
3. Disables the digital receiver blocks.
4. Powers down the receiver circuitry (ADC, RSSI, IF filter, mixer, and LNA).
5. Sets RF channel frequency (same as the previous receive channel frequency).
6. Sets the synthesizer bandwidth.
7. Does VCO calibration.
8. Delays for synthesizer settling.
9. Enables the digital transmitter blocks.
10. Sets the external PA signal high (if enabled).
11. Ramps up the PA.
12. Sets FW\_STATE = PHY\_TX.
13. Transmits data.

In sport mode, the RX\_TO\_TX\_AUTO\_TURNAROUND transition is disabled.

**TX\_TO\_RX\_AUTO\_TURNAROUND**

If the TX\_TO\_RX\_AUTO\_TURNAROUND bit in the MODE\_CONTROL register (Address 0x11A) is enabled, the device automatically transitions to the PHY\_RX state at the end of a packet transmission, on the same RF channel frequency. On the transition, the communications processor performs the following actions:

1. Ramps down the PA.
2. Sets the external PA signal low.
3. Disables the digital transmitter blocks.
4. Powers up the receiver circuitry (ADC, RSSI, IF filter, mixer, and LNA).
5. Sets the RF channel (same as the previous transmit channel frequency).
6. Sets the synthesizer bandwidth.
7. Does VCO calibration.
8. Delays for synthesizer settling.
9. Turns on AGC and AFC (if enabled).
10. Enables the digital receiver blocks.
11. Sets the external LNA signal high (if enabled).
12. Sets FW\_STATE = PHY\_RX.

In sport mode, the TX\_TO\_RX\_AUTO\_TURNAROUND transition is disabled.

**WUC Timeout**

The ADF7023 can use the WUC to wake from sleep on a timeout of the hardware timer. The device wakes into the PHY\_OFF state. See the WUC Mode section for further details.

**STATE TRANSITION AND COMMAND TIMING**

The execution times for all radio state transitions are detailed in Table 11 and Table 12. Note that these times are typical and can vary, depending on the BBRAM configuration.

For normal transition times, set TRANSITION\_CLOCK\_DIV (Location 0x13A) to 0x04. For fast transition times, set TRANSITION\_CLOCK\_DIV to 0x01. It is recommended to enable fast transition times to reduce system power consumption. As stated in the SPI Interface section, commands are executed on the last positive SCLK edge of the command. For the values given in Table 11 and Table 12, there is an additional 200 ns between the last positive SCLK edge and the rising edge of CS that is related to the SPI rate used.

Table 11. ADF7023 Command Execution Times and State Transition Times That Are Not Related to PHY\_TX or PHY\_RX

Command/Bit	Command Initiated By	Present State	Next State	Normal Transition Time ( $\mu$ s), Typical	Fast Transition Time ( $\mu$ s) Typical	Condition
CMD_HW_RESET	Host	Any	PHY_SLEEP	1	1	
CMD_PHY_SLEEP	Host	PHY_OFF	PHY_SLEEP	22.3	22.3	
CMD_PHY_SLEEP	Host	PHY_ON	PHY_SLEEP	24.1	24.1	
CMD_PHY_OFF	Host	PHY_ON	PHY_OFF	24	11	From rising edge of $\overline{CS}$ to CMD_FINISHED interrupt
CMD_PHY_ON	Host	PHY_OFF	PHY_ON	258/73	213/28	From rising edge of $\overline{CS}$ to CMD_FINISHED interrupt; IF filter calibration enabled/disabled
CMD_GET_RSSI	Host	PHY_ON	PHY_ON	631/450	523/353	RSSI_WAIT_TIME (Address 0x138) = 0xA7/0x37
CMD_CONFIG_DEV	Host	PHY_OFF	PHY_OFF	72	23	From rising edge of $\overline{CS}$ to CMD_FINISHED interrupt
CMD_CONFIG_DEV	Host	PHY_ON	PHY_ON	75.5	24.5	From rising edge of $\overline{CS}$ to CMD_FINISHED interrupt
CMD_BB_CAL	Host	PHY_ON	PHY_ON	221	204	From rising edge of $\overline{CS}$ to CMD_FINISHED interrupt
Wake-Up from PHY_SLEEP, (WUC Timeout)	Automatic	PHY_SLEEP	PHY_OFF	304	304	7 pF load capacitance, $T_A = 25^\circ\text{C}$
Wake-Up from PHY_SLEEP, ( $\overline{CS}$ Low)	Host	PHY_SLEEP	PHY_OFF	304	304	7 pF load capacitance, $T_A = 25^\circ\text{C}$
Cold Start	Application of power	N/A	PHY_OFF	304	304	7 pF load capacitance, $T_A = 25^\circ\text{C}$

Table 12. ADF7023 State Transition Times Related to PHY\_TX and PHY\_RX

Mode	Command/Bit/Automatic Transition	Present State	Next State	Normal Transition Time ( $\mu$ s) <sup>1, 2</sup> , Typical	Fast Transition Time ( $\mu$ s) <sup>1, 2</sup> , Typical	Condition
Packet	CMD_PHY_ON	PHY_TX	PHY_ON	$T_{EOP} + T_{PARAM\_DOWN} + T_{BYTE} + 43$	$T_{EOP} + T_{PARAM\_DOWN} + T_{BYTE} + 15$	From rising edge of $\overline{CS}$ to CMD_FINISHED interrupt
Packet	CMD_PHY_ON	PHY_RX	PHY_ON	$T_{BYTE} + 48$	$T_{BYTE} + 21$	From rising edge of $\overline{CS}$ to CMD_FINISHED interrupt, CMD_PHY_ON issued during search for preamble
				50.5	23	From rising edge of $\overline{CS}$ to CMD_FINISHED interrupt, CMD_PHY_ON issued during preamble qualification
				50.5	23	From rising edge of $\overline{CS}$ to CMD_FINISHED interrupt, CMD_PHY_ON issued during sync word qualification
				$T_{EOP} + 62.5$	$T_{EOP} + 18$	From rising edge of $\overline{CS}$ to CMD_FINISHED interrupt, CMD_PHY_ON issued during RX data (after a sync word)

Mode	Command/Bit/ Automatic Transition	Present State	Next State	Normal Transition Time ( $\mu\text{s}$ ) <sup>1, 2</sup> , Typical	Fast Transition Time ( $\mu\text{s}$ ) <sup>1, 2</sup> , Typical	Condition
Packet	CMD_PHY_TX	PHY_ON	PHY_TX	306	237	From rising edge of $\overline{\text{CS}}$ to CMD_FINISHED interrupt; PA ramp up starts 3.4 $\mu\text{s}$ after the interrupt; first bit of user data is transmitted $1.5 \times T_{\text{BIT}} + 2.3 \mu\text{s}$ following the interrupt
Packet	CMD_PHY_TX	PHY_RX	PHY_TX	$T_{\text{BYTE}} + 324.5$	$T_{\text{BYTE}} + 248$	From rising edge of $\overline{\text{CS}}$ to CMD_FINISHED interrupt, CMD_PHY_TX issued during search for preamble; PA ramp up starts 3.4 $\mu\text{s}$ after the interrupt; first bit of user data is transmitted $1.5 \times T_{\text{BIT}} + 2.3 \mu\text{s}$ following the interrupt
				322.5	245.5	From rising edge of $\overline{\text{CS}}$ to CMD_FINISHED interrupt, CMD_PHY_TX issued during preamble qualification; PA ramp up starts 3.4 $\mu\text{s}$ after the interrupt; first bit of user data is transmitted $1.5 \times T_{\text{BIT}} + 2.3 \mu\text{s}$ following the interrupt
				322.5	245.5	From rising edge of $\overline{\text{CS}}$ to CMD_FINISHED interrupt, CMD_PHY_TX issued during sync word qualification; PA ramp up starts 3.4 $\mu\text{s}$ after the interrupt; first bit of user data is transmitted $1.5 \times T_{\text{BIT}} + 2.3 \mu\text{s}$ following the interrupt
				$T_{\text{EOP}} + 281$	$T_{\text{EOP}} + 263$	From rising edge of $\overline{\text{CS}}$ to CMD_FINISHED interrupt, CMD_PHY_TX issued during RX data (after a sync word); PA ramp up starts 3.4 $\mu\text{s}$ after the interrupt; first bit of user data is transmitted $1.5 \times T_{\text{BIT}} + 2.3 \mu\text{s}$ following the interrupt
Packet	CMD_PHY_TX	PHY_TX	PHY_TX	$T_{\text{EOP}} + T_{\text{PARAMP\_DOWN}} + T_{\text{BYTE}} + 310$	$T_{\text{EOP}} + T_{\text{PARAMP\_DOWN}} + T_{\text{BYTE}} + 236$	From rising edge of $\overline{\text{CS}}$ to CMD_FINISHED interrupt. CMD_PHY_TX issued during packet transmission; PA ramp up starts 3.4 $\mu\text{s}$ after the interrupt; first bit of user data is transmitted $1.5 \times T_{\text{BIT}} + 2.3 \mu\text{s}$ following the interrupt
Packet	RX_TO_TX_AUTO_TURNAROUND	PHY_RX	PHY_TX	322	234.2	From INTERRUPT_CRC_CORRECT to CMD_FINISHED interrupt; PA ramp up starts 3.4 $\mu\text{s}$ after the interrupt; first bit of user data is transmitted $1.5 \times T_{\text{BIT}} + 2.3 \mu\text{s}$ following the interrupt
Packet	CMD_PHY_RX	PHY_ON	PHY_RX	327	241	From rising edge of $\overline{\text{CS}}$ to CMD_FINISHED interrupt
Packet	CMD_PHY_RX	PHY_TX	PHY_RX	$T_{\text{EOP}} + T_{\text{PARAMP\_DOWN}} + T_{\text{BYTE}} + 336$	$T_{\text{EOP}} + T_{\text{PARAMP\_DOWN}} + T_{\text{BYTE}} + 241$	From rising edge of $\overline{\text{CS}}$ to CMD_FINISHED interrupt; CMD_PHY_RX issued during packet transmission
Packet	CMD_PHY_RX	PHY_RX	PHY_RX	$T_{\text{BYTE}} + 341.5$	$T_{\text{BYTE}} + 249.5$	From rising edge of $\overline{\text{CS}}$ to CMD_FINISHED interrupt, CMD_PHY_RX issued during search for preamble
				339.5	249	From rising edge of $\overline{\text{CS}}$ to CMD_FINISHED interrupt, CMD_PHY_RX issued during preamble qualification
				339.5	249	From rising edge of $\overline{\text{CS}}$ to CMD_FINISHED interrupt, CMD_PHY_RX issued during sync word qualification
				$T_{\text{EOP}} + 354$	$T_{\text{EOP}} + 246$	From rising edge of $\overline{\text{CS}}$ to CMD_FINISHED interrupt, CMD_PHY_RX issued during RX data (after a sync word)



Mode	Command/Bit/ Automatic Transition	Present State	Next State	Normal Transition Time ( $\mu\text{s}$ ) <sup>1, 2</sup> , Typical	Fast Transition Time ( $\mu\text{s}$ ) <sup>1, 2</sup> , Typical	Condition
Packet	TX_TO_RX_AUTO _TURNAROUND	PHY_TX	PHY_RX	$T_{\text{PARAMP\_DOWN}} + T_{\text{BYTE}} + 322$	$T_{\text{PARAMP\_DOWN}} + T_{\text{BYTE}} + 232$	From TX_EOF interrupt to CMD_FINISHED interrupt
Packet	TX_EOF	PHY_TX	PHY_ON	$T_{\text{PARAMP\_DOWN}} + T_{\text{BYTE}} + 25$	$T_{\text{PARAMP\_DOWN}} + T_{\text{BYTE}} + 5$	From TX_EOF interrupt to CMD_FINISHED interrupt
Packet	RX_EOF	PHY_RX	PHY_ON	46	10	From INTERRUPT_CRC_CORRECT to CMD_FINISHED interrupt
Sport	CMD_PHY_ON	PHY_TX	PHY_ON	$T_{\text{PARAMP\_DOWN}} + 51$	$T_{\text{PARAMP\_DOWN}} + 22$	From rising edge of $\overline{\text{CS}}$ to CMD_FINISHED interrupt
Sport	CMD_PHY_ON	PHY_RX	PHY_ON	$T_{\text{BYTE}} + 54$	$T_{\text{BYTE}} + 28$	From rising edge of $\overline{\text{CS}}$ to CMD_FINISHED interrupt, CMD_PHY_ON issued during search for preamble
				50.5	23	From rising edge of $\overline{\text{CS}}$ to CMD_FINISHED interrupt, CMD_PHY_ON issued during preamble qualification
				50.5	23	From rising edge of $\overline{\text{CS}}$ to CMD_FINISHED interrupt, CMD_PHY_ON issued during sync word qualification
				56	26	From rising edge of $\overline{\text{CS}}$ to CMD_FINISHED interrupt, CMD_PHY_ON issued during RX data (after a sync word)
Sport	CMD_PHY_TX	PHY_ON	PHY_TX	306	237	From rising edge of $\overline{\text{CS}}$ to CMD_FINISHED interrupt; PA ramp up starts 3.4 $\mu\text{s}$ after the interrupt
Sport	CMD_PHY_TX	PHY_RX	PHY_TX	$T_{\text{BYTE}} + 325$	$T_{\text{BYTE}} + 250$	From rising edge of $\overline{\text{CS}}$ to CMD_FINISHED interrupt, CMD_PHY_TX issued during search for preamble; PA ramp up starts 3.4 $\mu\text{s}$ after the interrupt
				320	245	From rising edge of $\overline{\text{CS}}$ to CMD_FINISHED interrupt, CMD_PHY_TX issued during preamble qualification. The PA ramp up starts 3.4 $\mu\text{s}$ after the interrupt.
				320	245	From rising edge of $\overline{\text{CS}}$ to CMD_FINISHED interrupt, CMD_PHY_TX issued during sync word qualification; PA ramp up starts 3.4 $\mu\text{s}$ after the interrupt
				326	249	From rising edge of $\overline{\text{CS}}$ to CMD_FINISHED interrupt, CMD_PHY_TX issued during RX data (after a sync word). The PA ramp up starts 3.4 $\mu\text{s}$ after the interrupt.
Sport	CMD_PHY_TX	PHY_TX	PHY_TX	$T_{\text{PARAMP\_DOWN}} + 315$	$T_{\text{PARAMP\_DOWN}} + 243$	From rising edge of $\overline{\text{CS}}$ to CMD_FINISHED interrupt; PA ramp up starts 3.4 $\mu\text{s}$ after the interrupt
Sport	CMD_PHY_RX	PHY_ON	PHY_RX	327	241	From rising edge of $\overline{\text{CS}}$ to CMD_FINISHED interrupt
Sport	CMD_PHY_RX	PHY_TX	PHY_RX	$T_{\text{PARAMP\_DOWN}} + 345$	$T_{\text{PARAMP\_DOWN}} + 250$	From rising edge of $\overline{\text{CS}}$ to CMD_FINISHED interrupt

Mode	Command/Bit/ Automatic Transition	Present State	Next State	Normal Transition Time (μs) <sup>1, 2</sup> , Typical	Fast Transition Time (μs) <sup>1, 2</sup> , Typical	Condition
Sport	CMD_PHY_RX	PHY_RX	PHY_RX	$T_{\text{BYTE}} + 342$	$T_{\text{BYTE}} + 249.5$	From rising edge of $\overline{\text{CS}}$ to CMD_FINISHED interrupt, CMD_PHY_RX issued during search for preamble
				339.5	249	From rising edge of $\overline{\text{CS}}$ to CMD_FINISHED interrupt, CMD_PHY_RX issued during preamble qualification
				339.5	249	From rising edge of $\overline{\text{CS}}$ to CMD_FINISHED interrupt, CMD_PHY_RX issued during sync word qualification
				346	252	From rising edge of $\overline{\text{CS}}$ to CMD_FINISHED interrupt, CMD_PHY_RX issued during RX data (after a sync word)

<sup>1</sup>  $T_{\text{PARAM\_DOWN}} = T_{\text{PARAM\_UP}} = \frac{PA\_LEVEL\_MCR}{2^{(9 - PA\_RAMP)} \times DATA\_RATE \times 100}$ , where PA\_LEVEL\_MCR sets the maximum PA output power (PA\_LEVEL\_MCR register, Address 0x307), PA\_RAMP

sets the PA ramp rate (RADIO\_CFG\_8 register, Address 0x114), and DATA\_RATE sets the transmit data rate (RADIO\_CFG\_0 register, Address 0x10C and RADIO\_CFG\_1 register, Address 0x10D).

<sup>2</sup>  $T_{\text{BIT}}$  = one bit period (μs),  $T_{\text{BYTE}}$  = one byte period (μs),  $T_{\text{EOP}}$  = time to end of packet (μs).

## PACKET MODE

The on-chip communications processor can be configured for use with a wide variety of packet-based radio protocols using 2FSK/GFSK/MSK/GMSK/OOK modulation. The general packet format, when using the packet management features of the communications processor, is illustrated in Table 14. To use the packet management features, the DATA\_MODE setting in the PACKET\_LENGTH\_CONTROL register (Address 0x126) should be set to packet mode; 240 bytes of dedicated packet RAM are available to store, transmit, and receive packets. In transmit mode, preamble, sync word, and CRC can be added by the communications processor to the data stored in the packet RAM for transmission. In addition, all packet data after the sync word can be optionally whitened, Manchester encoded, or 8b/10b encoded on transmission and decoded on reception.

In receive mode, the communications processor can be used to qualify received packets based on the preamble detection, sync word detection, CRC detection, or address match and generate an interrupt on the IRQ\_GP3 pin. On reception of a valid packet, the received payload data is loaded to packet RAM memory. More information on interrupts is contained in the Interrupt Generation section.

### PREAMBLE

The preamble is a mandatory part of the packet that is automatically added by the communications processor when transmitting a packet and removed after receiving a packet. The preamble is a 0x55 sequence, with a programmable length between 1 byte and 256 bytes, that is set in the

PREAMBLE\_LEN register (Address 0x11D). It is necessary to have preamble at the beginning of the packet to allow time for the receiver AGC, AFC, and clock and data recovery circuitry to settle before the start of the sync word. The required preamble length depends on the radio configuration. See the Radio Blocks section for more details.

In receive mode, the ADF7023 can use a preamble qualification circuit to detect preamble and interrupt the host processor. The preamble qualification circuit tracks the received frame as a sliding window. The window is three bytes in length, and the preamble pattern is fixed at 0x55. The preamble bits are examined in 01pairs. If either bit or both bits are in error, the pair is deemed erroneous. The possible erroneous pairs are 00, 11, and 10. The number of erroneous pairs tolerated in the preamble can be set using the PREAMBLE\_MATCH register value (Address 0x11B) according to Table 13.

**Table 13. Preamble Detection Tolerance (PREAMBLE\_MATCH, Address 0x11B)**

Value	Description
0x0C	No errors allowed.
0x0B	One erroneous bit-pair allowed in 12 bit-pairs.
0x0A	Two erroneous bit-pairs allowed in 12 bit-pairs.
0x09	Three erroneous bit-pairs allowed in 12 bit-pairs.
0x08	Four erroneous bit-pairs allowed in 12 bit-pairs.
0x00	Preamble detection disabled.

**Table 14. ADF7023 Packet Structure Description<sup>1</sup>**

Packet Format Options	Packet Structure						
	Preamble	Sync	Payload			CRC	Postamble
			Length	Address	Payload Data		
Field Length	1 byte to 256 bytes	1 bit to 24 bits	1 byte	1 byte to 9 bytes	0 bytes to 240 bytes	2 bytes	2 bytes
Optional Field in Packet Structure	X	X	Yes	Yes	Yes	Yes	X
Comms Processor Adds in Tx, Removes in Rx	Yes	Yes	X	X	X	Yes	Yes
Host Writes These Fields to Packet RAM	X	X	Yes	Yes	Yes	X	X
Whitening/Dewhitening (Optional)	X	X	Yes	Yes	Yes	Yes	X
Manchester Encoding/Decoding (Optional)	X	X	Yes	Yes	Yes	Yes	X
8b/10b Encoding/Decoding (Optional)	X	X	Yes	Yes	Yes	Yes	X
Configurable Parameter	Yes	Yes	Yes	Yes	Yes	Yes	X
Receive Interrupt on Valid Field Detection	Yes	Yes	X	Yes	X	Yes	X
Programmable Field Error Tolerance	Yes	Yes	X	X	X	X	X
Programmable Field Offset (See Figure 78)	X	X	X	Yes	X	X	X

<sup>1</sup> Yes indicates that the packet format option is supported; X indicates that the packet format option is not supported.

If PREAMBLE\_MATCH is set to 0x0C, the ADF7023 must receive 12 consecutive 01 pairs (three bytes) to confirm that valid preamble has been detected. The user can select the option to automatically lock the AFC and/or AGC once the qualified preamble is detected. The AFC lock on preamble detection can be enabled by setting AFC\_LOCK\_MODE = 3 in the RADIO\_CFG\_10 register (Address 0x116:). The AGC lock on preamble detection can be enabled by setting AGC\_LOCK\_MODE = 3 in the RADIO\_CFG\_7 register (Address 0x113).

After the preamble is detected and the end of preamble has been reached, the communications processor searches for the sync word. The search for the sync word lasts for a duration equal to the sum of the number of programmed sync word bits, plus the preamble matching tolerance (in bits) plus 16 bits. If the sync word routine is detected during this duration, the communications processor loads the received payload to packet RAM and computes the CRC (if enabled). If the sync word routine is not detected during this duration, the communications processor continues searching for the preamble.

Preamble detection can be disabled by setting the PREAMBLE\_MATCH register to 0x00. To enable an interrupt upon preamble detection, the user must set INTERRUPT\_PREAMBLE\_DETECT = 1 in the INTERRUPT\_MASK\_0 register (Address 0x100).

**SYNC WORD**

Sync word is the synchronization word used by the receiver for byte level synchronization, while also providing an optional interrupt on detection. It is automatically added to the packet by the communications processor in transmit mode and removed during reception of a packet.

The value of the sync word is set in the SYNC\_BYTE\_0, SYNC\_BYTE\_1, and SYNC\_BYTE\_2 registers (Address 0x121, Address 0x122, and Address 0x123, respectively). The sync word is transmitted most significant bit first starting with SYNC\_BYTE\_0. The sync word matching length at the receiver is set using SYNC\_WORD\_LENGTH in the SYNC\_CONTROL register (Address 0x120) and can be one bit to 24 bits long; the transmitted sync word is a multiple of eight bits. Therefore, for nonbyte length sync words, the transmitted sync pattern should be appended with the preamble pattern as described in Figure 76 and Table 16.

In receive mode, the ADF7023 can provide an interrupt on reception of the sync word sequence programmed in the SYNC\_BYTE\_0, SYNC\_BYTE\_1, and SYNC\_BYTE\_2 registers. This feature can be used to alert the host processor that a qualified sync word has been received. An error tolerance parameter can also be programmed that accepts a valid match when up to three bits of the sync word sequence are incorrect. The error tolerance value is set using the SYNC\_ERROR\_TOL setting in the SYNC\_CONTROL register (Address 0x120), as described in Table 15.

**Table 15. Sync Word Detection Tolerance (SYNC\_ERROR\_TOL, Address 0x120)**

Value	Description
00	No bit errors allowed.
01	One bit error allowed.
10	Two bit errors allowed.
11	Three bit errors allowed.

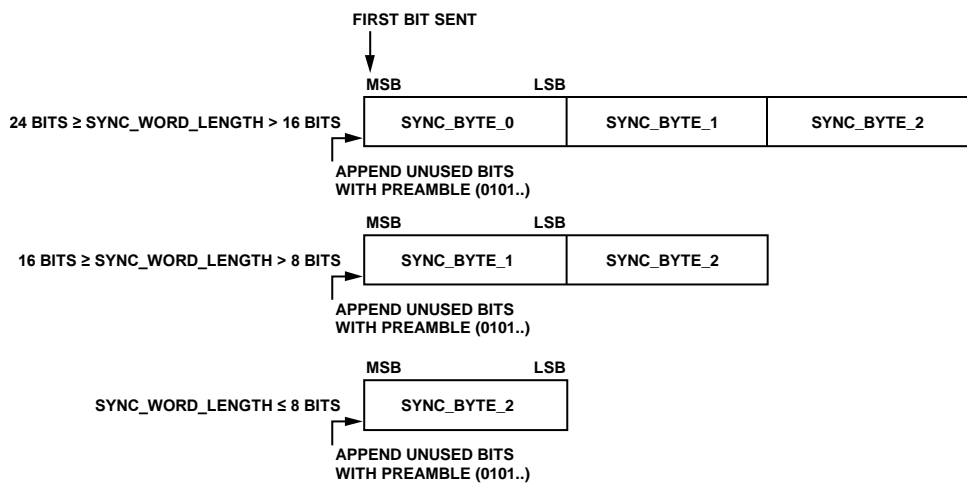

Figure 76. Transmit Sync Word Configuration

08231-068

Table 16. Sync Word Programming Examples

Required Sync Word (Binary, First Bit Being First in Time)	SYNC_WORD_LENGTH Bits in SYNC_CONTROL REGISTER (0x120)	SYNC_BYTE_0 <sup>1</sup>	SYNC_BYTE_1 <sup>1</sup>	SYNC_BYTE_2	Transmitted Sync Word (Binary, First Bit Being First in Time)	Receiver Sync Word Match Length (Bits)
000100100011010001010110	24	0x12	0x34	0x56	0001_0010_0011_0100_0101_0110	24
111010011100101000100	21	0x5D	0x39	0x44	0101_1101_0011_1001_0100_0100	21
0001001000110100	16	0xXX	0x12	0x34	0001_0010_0011_0100	16
011100001110	12	0xXX	0x57	0x0E	0101_0111_0000_1110	12
00010010	8	0xXX	0xXX	0x12	0001_0010	8
011100	6	0xXX	0xXX	0x5C	0101_1100	6

<sup>1</sup>X = don't care.

**Choice of Sync Word**

The sync word should be chosen to have low correlation with the preamble and have good autocorrelation properties. When the AFC is set to lock on detection of sync word (AFC\_LOCK\_MODE = 3 and PREAMBLE\_MATCH = 0), the sync word should be chosen to be dc free, and it should have a run length limit not greater than four bits.

**PAYLOAD**

The host processor writes the transmit data payload to the packet RAM. The location of the transmit data in the packet RAM is defined by the TX\_BASE\_ADR value register (Address 0x124). The TX\_BASE\_ADR value is the location of the first byte of the transmit payload data in the packet RAM. On reception of a valid sync word, the communications processor automatically loads the receive payload to the packet RAM. The RX\_BASE\_ADR register value (Address 0x125) sets the location in the packet RAM of the first byte of the received payload. For more details on packet RAM memory, see the ADF7023 Memory Map section.

**Byte Orientation**

The over-the-air arrangement of each transmitted packet RAM byte can be set to MSB first or LSB first using the DATA\_BYTE setting in the PACKET\_LENGTH\_CONTROL register (Address 0x126). The same orientation setting should be used on the transmit and receive sides of the RF link.

**Packet Length Modes**

The ADF7023 can be used in both fixed and variable length packet systems. Fixed or variable length packet mode is set using the PACKET\_LEN variable setting in the PACKET\_LENGTH\_CONTROL register (Address 0x126).

For a fixed packet length system, the length of the transmit and received payload is set by the PACKET\_LENGTH\_MAX register (Address 0x127). The payload length is defined as the number of bytes from the end of the sync word to the start of the CRC.

In variable packet length mode, the communications processor extracts the length field from the received payload data. In transmit mode, the length field must be the first byte in the transmit payload.

The communications processor calculates the actual received payload length as

$$RxPayload\ Length = Length + LENGTH\_OFFSET - 4$$

where:

Length is the length field (the first byte in the received payload). LENGTH\_OFFSET is a programmable offset (set in the PACKET\_LENGTH\_CONTROL register (Address 0x126).

The LENGTH\_OFFSET value allows compatibility with systems where the length field in the proprietary packet may also include the length of the CRC and/or the sync word. The ADF7023 defines the payload length as the number of bytes from the end of the sync word to the start of the CRC. In variable packet length mode, the PACKET\_LENGTH\_MAX value defines the maximum packet length that can be received, as described in Figure 77.

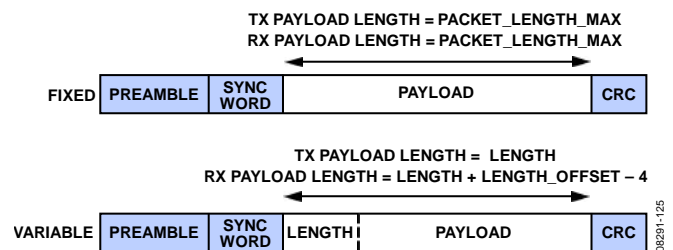

Figure 77. Payload Length in Fixed and Variable Length Packet Modes

**Addressing**

The ADF7023 provides a very flexible address matching scheme, allowing matching of a single address, multiple addresses, and broadcast addresses. Addresses up to 32 bits in length are supported. The address information can be included at any section of the transmit payload. The location of the starting byte of the address data in the received payload is set in the ADDRESS\_MATCH\_OFFSET register (Address 0x129), as illustrated in Figure 78. The number of bytes in the first address field is set in the ADDRESS\_LENGTH register (Address 0x12A). These settings allow the communications processor to extract the address information from the received packet.

The address data is then compared against a list of known addresses that are stored in BBRAM (Address 0x12B to Address 0x137). Each stored address byte has an associated mask byte, thereby allowing matching of partial sections of the address bytes, which is useful for checking broadcast addresses or a family of addresses that have a unique identifier in the address sequence. The format and placement of the address information in the payload data should match the address check settings at the receiver to ensure exact address detection and qualification. Table 17 shows the register locations in the BBRAM that are used for setup of the address checking. When Register 0x12A (number of bytes in the first address field) is set to 0x00, address checking is disabled. Note that if static register fixes are employed (see Table 91), the space available for address matching is reduced.

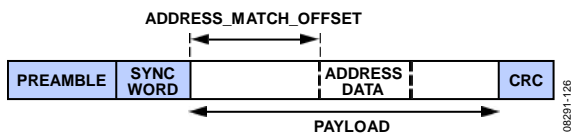

Figure 78. Address Match Offset

Table 17. Address Check Register Setup

Address (BBRAM)	Description <sup>1</sup>
0x129, ADDRESS_MATCH_OFFSET	Position of first address byte in the received packet (first byte after sync word = 0)
0x12A, ADDRESS_LENGTH	Number of bytes in the first address field ( $N_{ADR,1}$ )
0x12B	Address Match Byte 0
0x12C	Address Mask Byte 0
0x12D	Address Match Byte 1
0x12E	Address Mask Byte 1
...	...
	Address Match Byte $N_{ADR,1} - 1$
	Address Mask Byte $N_{ADR,1} - 1$
	0x00 to end or $N_{ADR,2}$ for another address check sequence

<sup>1</sup>  $N_{ADR,1}$  = the number of bytes in the first address field;  $N_{ADR,2}$  = the number of bytes in the second address field.

The host processor should set the INTERRUPT\_ADDRESS\_MATCH bit in the INTERRUPT\_SOURCE\_0 register (Address 0x336) if an interrupt is required on the IRQ\_GP3 pin. Additional information on interrupts is contained in the Interrupt Generation section.

**Example Address Check**

Consider a system with 16-bit address lengths, in which the first byte is located in the 10<sup>th</sup> byte of the received payload data. The system also uses broadcast addresses in which the first byte is always 0xAA. To match the exact address, 0xABCD or any broadcast address in the form 0xAAXX, the ADF7023 must be configured as shown in Table 18.

Table 18. Example Address Check Configuration

BBRAM Address	Value	Description
0x129	0x09	Location in payload of the first address byte
0x12A	0x02	Number of bytes in the first address field, $N_{ADR,1} = 2$
0x12B	0xAB	Address Match Byte 0
0x12C	0xFF	Address Mask Byte 0
0x12D	0xCD	Address Match Byte 1
0x12E	0xFF	Address Mask Byte 1
0x12F	0x02	Number of bytes in the second address field, $N_{ADR,2} = 2$
0x130	0xAA	Address Match Byte 0
0x131	0xFF	Address Mask Byte 0
0x132	0x00	Address Match Byte 1
0x133	0x00	Address Mask Byte 1
0x134	0x00	End of addresses (indicated by 0x00)
0x135	0XX	Don't care
0x136	0XX	Don't care
0x137	0XX	Don't care

**CRC**

An optional CRC-16 can be appended to the packet by setting  $CRC\_EN = 1$  in the PACKET\_LENGTH\_CONTROL register (Address 0x126). In receive mode, this bit enables CRC detection on the received packet. A default polynomial is used if  $PROG\_CRC\_EN = 0$  in the SYMBOL\_MODE register (Address 0x11C). The default CRC polynomial is

$$g(x) = x^{16} + x^{12} + x^5 + 1$$

Any other 16-bit polynomial can be used if  $PROG\_CRC\_EN = 1$ , and the polynomial is set in  $CRC\_POLY\_0$  and  $CRC\_POLY\_1$  (Address 0x11E and Address 0x11F, respectively). The setup of the CRC is described in Table 19. The CRC is initialized with 0x0000.

Table 19. CRC Setup

CRC_EN Bit in the PACKET_LENGTH_CONTROL Register	PROG_CRC_EN Bit in the SYMBOL_MODE Register	Description
0	X <sup>1</sup>	CRC is disabled in transmit, and CRC detection is disabled in receive.
1	0	CRC is enabled in transmit, and CRC detection is enabled in receive, with the default CRC polynomial.
1	1	CRC is enabled in transmit, and CRC detection is enabled in receive, with the CRC polynomial defined by $CRC\_POLY\_0$ and $CRC\_POLY\_1$ .

<sup>1</sup> X = don't care.

To convert a user-defined polynomial to the 2-byte value, the polynomial should be written in binary format. The  $x^{16}$  coefficient is assumed equal to 1 and is, therefore, discarded. The remaining 16 bits then make up CRC\_POLY\_0 (most significant byte) and CRC\_POLY\_1 (least significant byte). Two examples of setting common 16-bit CRCs are shown in Table 20.

**Table 20. Example: Programming of CRC\_POLY\_0 and CRC\_POLY\_1**

Polynomial	Binary Format	CRC_POLY_0	CRC_POLY_1
$x^{16} + x^{15} + x^2 + 1$ (CRC-16-IBM)	1_1000_0000_ 0000_0101	0x80	0x05
$x^{16} + x^{13} + x^{12} + x^{11} + x^{10} + x^8 + x^6 + x^5 + x^2 + 1$ (CRC-16-DNP)	1_0011_1101_ 0110_0101	0x3D	0x65

To enable CRC detection on the receiver, with the default CRC or user-defined 16-bit CRC, CRC\_EN in the PACKET\_LENGTH\_CONTROL register (Address 0x126) should be set to 1. An interrupt can be generated on reception of a CRC verified packet (see the Interrupt Generation section).

**POSTAMBLE**

The communications processor automatically appends two bytes of postamble to the end of the transmitted packet. Each byte of the postamble is 0x55. The first byte is transmitted immediately after the CRC. The PA ramp-down begins immediately after the first postamble byte. The second byte is transmitted while the PA is ramping down.

On the receiver, if the received packet is valid, the RSSI is automatically measured during the first postamble byte, and the result is stored in the RSSI\_READBACK register (Address 0x312). The RSSI is measured by the communications processor 17  $\mu$ s after the last CRC bit.

**TRANSMIT PACKET TIMING**

The PA ramp timing in relation to the transmit packet data is described in Figure 79. After the CMD\_PHY\_TX command is issued, a VCO calibration is carried out, followed by a delay for synthesizer settling. The PA ramp follows the synthesizer settling. After the PA is ramped up to the programmed rate, there is 1-byte delay before the start of modulation (preamble). At the beginning of the second byte of postamble, the PA ramps down. The communications processor then transitions to the PHY\_ON state or the PHY\_RX state (if the TX\_AUTO\_TURN\_AROUND bit is enabled or the CMD\_PHY\_RX command is issued).

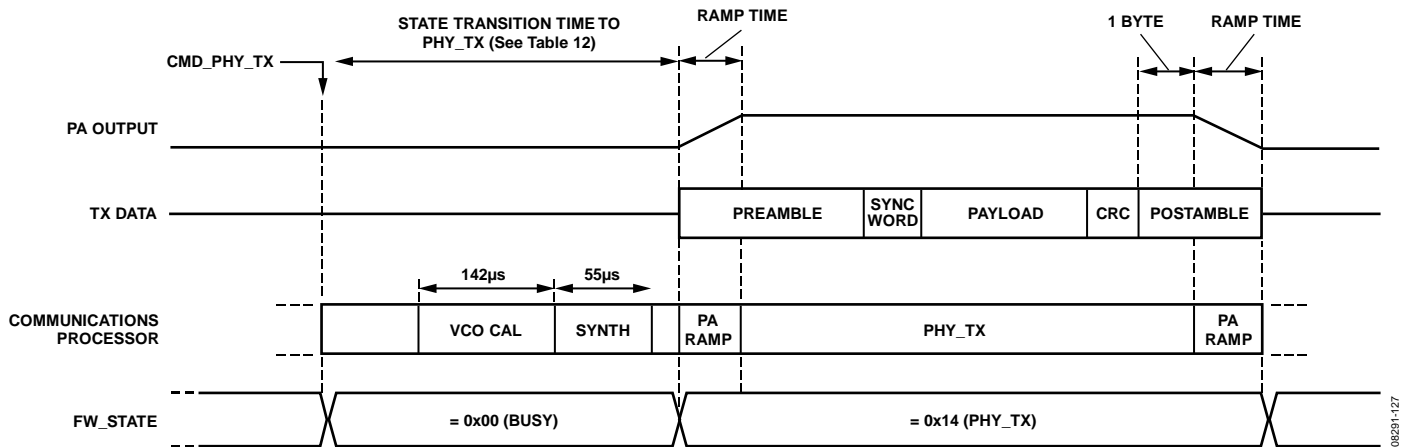

Figure 79. Transmit Packet Timing

08291-127

### DATA WHITENING

Data whitening can be employed to avoid long runs of 1s or 0s in the transmitted data stream. This ensures sufficient bit transitions in the packet, which aids in receiver clock and data recovery because the encoding breaks up long runs of 1s or 0s in the transmit packet. The data, excluding the preamble and sync word, is automatically whitened before transmission by XOR'ing the data with an 8-bit pseudorandom sequence. At the receiver, the data is XOR'ed with the same pseudorandom sequence, thereby reversing the whitening. The linear feedback shift register polynomial used is  $x^7 + x^1 + 1$ . Data whitening and dewatering are enabled by setting `DATA_WHITENING = 1` in the `SYMBOL_MODE` register (Address 0x11C).

### MANCHESTER ENCODING

Manchester encoding can be used to ensure a dc-free (zero mean) transmission. The encoded over-the-air bit rate (chip rate) is double the rate set by the `DATA_RATE` variable (Address 0x10C and Address 0x10D). A Binary 0 is mapped to 10, and a Binary 1 is mapped to 01. Manchester encoding and decoding are applied to the payload data and the CRC. It is recommended to use Manchester encoding for OOK modulation. Manchester encoding and decoding are enabled by setting `MANCHESTER_ENC = 1` in the `SYMBOL_MODE` register (Address 0x11C).

### 8B/10B ENCODING

8b/10b encoding is a byte-orientated encoding scheme that maps an 8-bit byte to a 10-bit data block. It ensures that the maximum number of consecutive 1s or 0s (that is, run length) in any 10-bit transmitted symbol is five. The advantage of this encoding scheme is that dc balancing is employed without the efficiency loss of Manchester encoding. The rate loss for 8b/10b encoding is 0.8, whereas for Manchester encoding, it is 0.5. Encoding and decoding are applied to the payload data and the CRC. The 8b/10b encoding and decoding are enabled by setting `EIGHT_TEN_ENC = 1` in the `SYMBOL_MODE` register (Address 0x11C).



## SPORT MODE

It is possible to bypass all of the packet management features of the ADF7023 and use the sport interface for transmit and receive data. The sport interface is a high speed synchronous serial interface allowing direct interfacing to processors and DSPs. Sport mode is enabled using the DATA\_MODE setting in the PACKET\_LENGTH\_CONTROL register (Address 0x126), as described in Table 21. The sport mode interface is on the GPIO pins (GP0, GP1, GP2, GP4, and XOSC32KP\_GP5\_ATB1). These GPIO pins can be configured using the GPIO\_CONFIGURE setting (Address 0x3FA), as described in Table 22.

Sport mode provides a receive interrupt source on GP4. This interrupt source can be configured to provide an interrupt, or strobe signal, on either preamble detection or sync word detection. The type of interrupt is configured using the GPIO\_CONFIGURE setting.

### PACKET STRUCTURE IN SPORT MODE

In sport mode, the host processor has full control over the packet structure. However, the preamble frame is still required to allow sufficient bits for receiver settling (AGC, AFC, and CDR). In sport mode, sync word detection is not mandatory in the ADF7023 but can be enabled to provide byte level synchronization for the host processor via the sync word detect interrupt or strobe on GP4. The general format of a sport mode packet is shown in Figure 80.

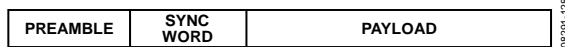

Figure 80. General Sport Mode Packet

### SPORT MODE IN TRANSMIT

Figure 81 illustrates the operation of the sport interface in transmit. Once in the PHY\_TX state with sport mode enabled, the data input of the transmitter is fully controlled by the sport

interface (Pin GP1). The transmit clock appears on the GP2 pin. The transmit data from the host processor should be synchronized with this clock. The FW\_STATE variable in the status word or the CMD\_FINISHED interrupt can be used to indicate when the ADF7023 has reached the PHY\_TX state and, therefore, is ready to begin transmitting data. The ADF7023 keeps transmitting the serial data presented at the GP1 input until the host processor issues a command to exit the PHY\_TX state.

### SPORT MODE IN RECEIVE

The sport interface supports the receive operation with a number of modes to suit particular signaling requirements. The receive data appears on the GP0 pin, whereas the receive synchronized clock appears on the GP2 pin. The GP4 pin provides an interrupt or strobe signal on either preamble or sync word detection, as described in Table 21 and Table 22. Once enabled, the interrupt signal and strobe signals remain operational while in the PHY\_RX state. The strobe signal gives a single high pulse of 1-bit duration every eight bits. The strobe signal is most useful when used with sync word detection because it is synchronized to the sync word and strobes the first bit in every byte.

### TRANSMIT BIT LATENCIES IN SPORT MODE

The transmit bit latency is the time from the sampling of a bit by the transmit data clock on GP2 to when that bit appears at the RF output. There is no transmit bit latency when using 2FSK/MSK modulation. The latency when using GFSK/GMSK modulation is two bits. It is important that the host processor keep the ADF7023 in the PHY\_TX state for two bit periods after the last data bit is sampled by the data clock to account for this latency when using GMSK/GFSK modulation.

Table 21. SPORT Mode Setup

DATA_MODE Bits in PACKET_LENGTH_CONTROL Register	Description	GPIO Configuration
DATA_MODE = 0	Packet mode enabled. Packet management is controlled by the communications processor.	
DATA_MODE = 1	Sport mode enabled. The Rx data and Rx clock are enabled in the PHY_RX state (GPIO_CONFIGURE = 0xA0, 0xA3, 0xA6). The Rx clock is enabled in the PHY_RX state, and Rx data is enabled on the preamble detect (GPIO_CONFIGURE = 0xA1, 0xA2, 0xA4, 0xA5, 0xA7, 0xA8).	GP0: Rx data GP1: Tx data GP2: Tx/Rx clock GP4: interrupt or strobe enabled on preamble detect (depends on GPIO_CONFIGURE) XOSC32KP_GP5_ATB1: depends on GPIO_CONFIGURE
DATA_MODE = 2	Sport mode enabled. The Rx data and Rx clock are enabled in the PHY_RX state if GPIO_CONFIGURE = 0xA0, 0xA3, 0xA6. The Rx clock is enabled in the PHY_RX state, and Rx data is enabled on the preamble detect if GPIO_CONFIGURE = 0xA1, 0xA2, 0xA4, 0xA5, 0xA7, 0xA8.	GP0: Rx data GP1: Tx data GP2: Tx/Rx clock GP4: interrupt or strobe enabled on sync word detect (depends on GPIO_CONFIGURE) XOSC32KP_GP5_ATB1: depends on GPIO_CONFIGURE

Table 22. GPIO Functionality in Sport Mode

GPIO_CONFIGURE	GP0	GP1	GP2	GP4	XOSC32KP_GP5_ATB1
0xA0	Rx data	Tx data	Tx/Rx clock	Not used	Not used
0xA1	Rx data	Tx data	Tx/Rx clock	Interrupt	Not used
0xA2	Rx data	Tx data	Tx/Rx clock	Strobe	Not used
0xA3	Rx data	Tx data	Tx/Rx clock	Not used	32.768 kHz XTAL input
0xA4	Rx data	Tx data	Tx/Rx clock	Interrupt	32.768 kHz XTAL input
0xA5	Rx data	Tx data	Tx/Rx clock	Strobe	32.768 kHz XTAL input
0xA6	Rx data	Tx data	Tx/Rx clock	Not used	EXT_UC_CLK output
0xA7	Rx data	Tx data	Tx/Rx clock	Interrupt	EXT_UC_CLK output
0xA8	Rx data	Tx data	Tx/Rx clock	Strobe	EXT_UC_CLK output



Figure 81. Sport Mode Transmit



Figure 82. Sport Mode Receive, DATA\_MODE = 1, 2 and GPIO\_CONFIGURE = 0xA0, 0xA3, 0xA6

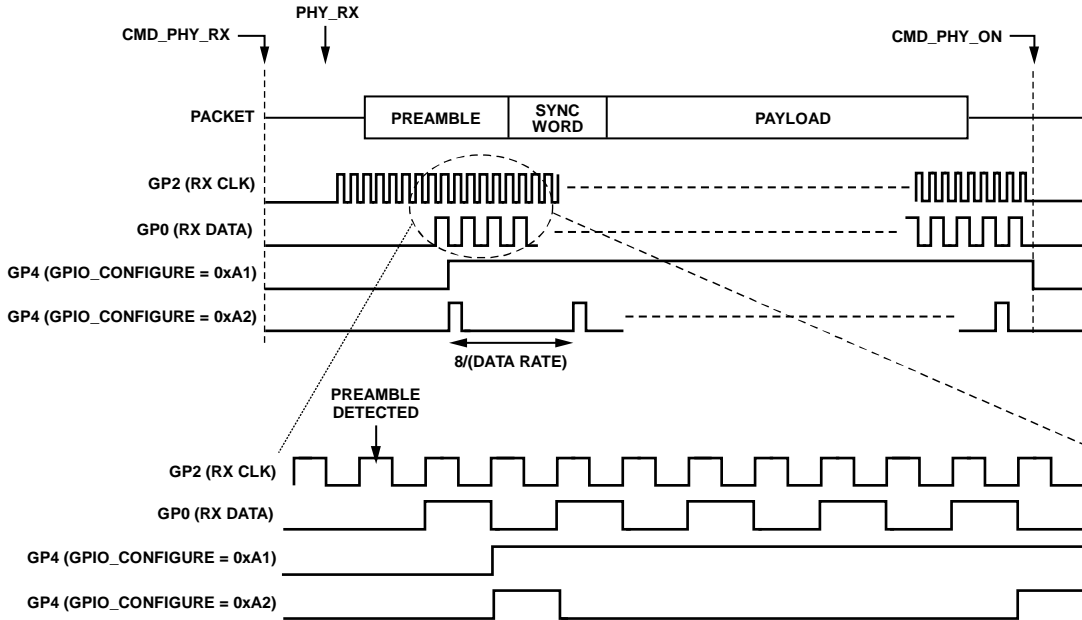

Figure 83. Sport Mode Receive, DATA\_MODE = 1, GPIO\_CONFIGURE = 0xA1, 0xA2, 0xA4, 0xA5, 0xA7, 0xA8

06291-131



Figure 84. Sport Mode Receive, DATA\_MODE = 2, GPIO\_CONFIGURE = 0xA1, 0xA2, 0xA4, 0xA5, 0xA7, 0xA8

06291-132

## INTERRUPT GENERATION

The ADF7023 uses a highly flexible, powerful interrupt system with support for MAC level interrupts and PHY level interrupts. To enable an interrupt source, the corresponding mask bit must be set. When an enabled interrupt occurs, the IRQ\_GP3 pin goes high, and the interrupt bit of the status word is set to Logic 1. The host processor can use either the IRQ\_GP3 pin or the status word to check for an interrupt. After an interrupt is asserted, the ADF7023 continues operations unaffected, unless it is directed to do otherwise by the host processor. An outline of the interrupt source and mask system is shown in Table 23.

MAC interrupts can be enabled by writing a Logic 1 to the relevant bits of the INTERRUPT\_MASK\_0 register (Address 0x100) and PHY level interrupts by writing a Logic 1 to the relevant bits of the INTERRUPT\_MASK\_1 register (Address 0x101). The structure of these memory locations is described in Table 23.

In the case of an interrupt condition, the interrupt source can be determined by reading the INTERRUPT\_SOURCE\_0 register (Address 0x336) and the INTERRUPT\_SOURCE\_1 register (Address 0x337). The bit that corresponds to the relevant

interrupt condition is high. The structure of these two registers is shown in Table 24.

Following an interrupt condition, the host processor should clear the relevant interrupt flag so that further interrupts assert the IRQ\_GP3 pin. This is performed by writing a Logic 1 to the bit that is high in either the INTERRUPT\_SOURCE\_0 or INTERRUPT\_SOURCE\_1 register. If multiple bits in the interrupt source registers are high, they can be cleared individually or altogether by writing Logic 1 to them. The IRQ\_GP3 pin goes low when all the interrupt source bits are cleared.

As an example, take the case where a battery alarm (in the INTERRUPT\_SOURCE\_1 register) interrupt occurs. The host processor should

1. Read the interrupt source registers. In this example, if none of the interrupt flags in INTERRUPT\_SOURCE\_0 is enabled, only INTERRUPT\_SOURCE\_1 must be read.
2. Clear the interrupt by writing 0x80 (or 0xFF) to INTERRUPT\_SOURCE\_1.
3. Respond to the interrupt condition.

**Table 23. Structure of the Interrupt Mask Registers**

Register	Bit	Name	Description
INTERRUPT_MASK_0, Address 0x100	7	INTERRUPT_NUM_WAKEUPS	Interrupt when the number of WUC wake-ups (NUMBER_OF_WAKEUPS[15:0]) has reached the threshold (NUMBER_OF_WAKEUPS_IRQ_THRESHOLD[15:0]) 1: interrupt enabled; 0: interrupt disabled
	6	INTERRUPT_SWM_RSSI_DET	Interrupt when the measured RSSI during smart wake mode has exceeded the RSSI threshold value (SWM_RSSI_THRESH, Address 0x108) 1: interrupt enabled; 0: interrupt disabled
	5	INTERRUPT_AES_DONE	Interrupt when an AES encryption or decryption command is complete; available only when the AES firmware module has been loaded to the ADF7023 program RAM 1: interrupt enabled; 0: interrupt disabled
	4	INTERRUPT_TX_EOF	Interrupt when a packet has finished transmitting 1: interrupt enabled; 0: interrupt disabled
	3	INTERRUPT_ADDRESS_MATCH	Interrupt when a received packet has a valid address match 1: interrupt enabled; 0: interrupt disabled
	2	INTERRUPT_CRC_CORRECT	Interrupt when a received packet has the correct CRC 1: interrupt enabled; 0: interrupt disabled
	1	INTERRUPT_SYNC_DETECT	Interrupt when a qualified sync word has been detected in the received packet 1: interrupt enabled; 0: interrupt disabled
	0	INTERRUPT_PREAMBLE_DETECT	Interrupt when a qualified preamble has been detected in the received packet 1: interrupt enabled; 0: interrupt disabled

Register	Bit	Name	Description
INTERRUPT_MASK_1, Address 0x101	7	BATTERY_ALARM	Interrupt when the battery voltage has dropped below the threshold value (BATTERY_MONITOR_THRESHOLD_VOLTAGE, Address 0x32D) 1: interrupt enabled; 0: interrupt disabled
	6	CMD_READY	Interrupt when the communications processor is ready to load a new command; mirrors the CMD_READY bit of the status word 1: interrupt enabled; 0: interrupt disabled
	5	Reserved	
	4	WUC_TIMEOUT	Interrupt when the WUC has timed out 1: interrupt enabled; 0: interrupt disabled
	3	Reserved	
	2	Reserved	
	1	SPI_READY	Interrupt when the SPI is ready for access 1: interrupt enabled; 0: interrupt disabled
	0	CMD_FINISHED	Interrupt when the communications processor has finished performing a command 1: interrupt enabled; 0: interrupt disabled

Table 24. Structure of the Interrupt Source Registers

Register	Bit	Name	Interrupt Description
INTERRUPT_SOURCE_0, Address: 0x336	7	INTERRUPT_NUM_WAKEUPS	Asserted when the number of WUC wake-ups (NUMBER_OF_WAKEUPS[15:0]) has reached the threshold (NUMBER_OF_WAKEUPS_IRQ_THRESHOLD[15:0]).
	6	INTERRUPT_SWM_RSSI_DET	Asserted when the measured RSSI during smart wake mode has exceeded the RSSI threshold value (SWM_RSSI_THRESH, Address 0x108).
	5	INTERRUPT_AES_DONE	Asserted when an AES encryption or decryption command is complete; available only when the AES firmware module has been loaded to the ADF7023 program RAM.
	4	INTERRUPT_TX_EOF	Asserted when a packet has finished transmitting (packet mode only).
	3	INTERRUPT_ADDRESS_MATCH	Asserted when a received packet has a valid address match (packet mode only).
	2	INTERRUPT_CRC_CORRECT	Asserted when a received packet has the correct CRC (packet mode only).
	1	INTERRUPT_SYNC_DETECT	Asserted when a qualified sync word has been detected in the received packet.
	0	INTERRUPT_PREAMBLE_DETECT	Asserted when a qualified preamble has been detected in the received packet.
INTERRUPT_SOURCE_1, Address: 0x337	7	BATTERY_ALARM	Asserted when the battery voltage has dropped below the threshold value (BATTERY_MONITOR_THRESHOLD_VOLTAGE, Address 0x32D).
	6	CMD_READY	Asserted when the communications processor is ready to load a new command; mirrors the CMD_READY bit of the status word.
	5	Reserved	
	4	WUC_TIMEOUT	Asserted when the WUC has timed out.
	3	Reserved	
	2	Reserved	
	1	SPI_READY	Asserted when the SPI is ready for access.
	0	CMD_FINISHED	Asserted when the communications processor has finished performing a command. If the CMD_FINISHED interrupt is enabled, following the issue of CMD_PHY_TX, the first bit of user data is transmitted $1.5 \times T_{BIT} + 2.3 \mu s$ following the interrupt. The PA ramp starts $3.4 \mu s$ after the interrupt. ( $T_{BIT}$ is the time taken to transmit one bit.)

## INTERRUPTS IN SPORT MODE

In sport mode, the interrupts from INTERRUPT\_SOURCE\_1 are all available. However, only INTERRUPT\_PREAMBLE\_DETECT and INTERRUPT\_SYNC\_DETECT are available from INTERRUPT\_SOURCE\_0. A second interrupt pin is

provided on GP4, which gives a dedicated sport mode interrupt on either preamble or sync word detection. For more details, see the Sport Mode section.

## ADF7023 MEMORY MAP

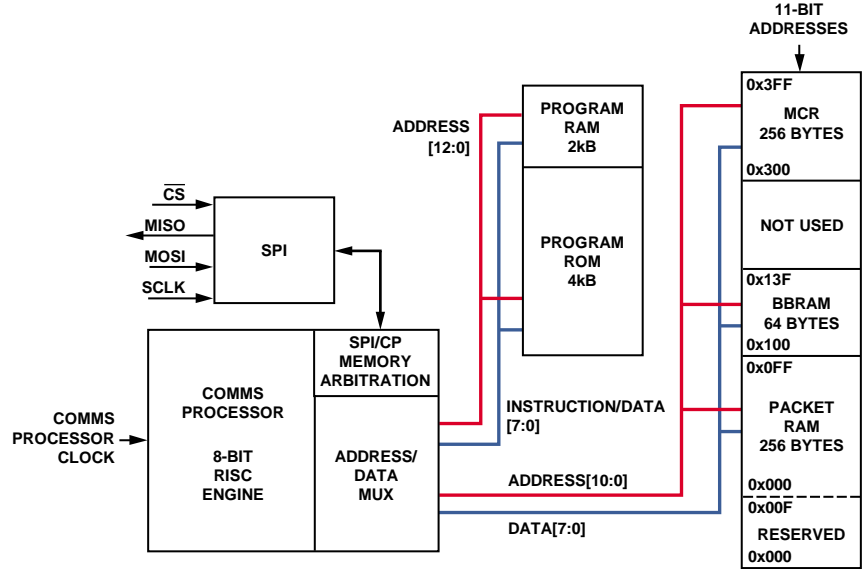

Figure 85. ADF7023 Memory Map

This section describes the various memory locations used by the ADF7023. The radio control, packet management, and smart wake mode capabilities of the part are realized through the use of an integrated RISC processor, which executes instructions stored in the embedded program ROM. There is also a local RAM, subdivided into three sections, that is used as a data packet buffer, both for transmitted and received data (packet RAM), and for storing the radio and packet management configuration (BBRAM and MCR). The RAM addresses of these memory banks are 11 bits long.

**BBRAM**

The battery backup RAM (BBRAM) contains the main radio and packet management registers used to configure the radio. On application of battery power to the ADF7023 for the first time, the entire BBRAM should be initialized by the host processor with the appropriate settings. After the BBRAM has been written to, the `CMD_CONFIG_DEV` command should be issued to update the radio and communications processor with the current BBRAM settings. The `CMD_CONFIG_DEV` command can be issued in the `PHY_OFF` state or the `PHY_ON` state only.

The BBRAM is used to maintain settings needed at wake-up from sleep mode by the wake-up controller. Upon wake-up from sleep, in smart wake mode, the BBRAM contents are read by the on-chip processor to recover the packet management and radio parameters.

**MODEM CONFIGURATION RAM (MCR)**

The 256-byte modem configuration RAM (MCR) contains the various registers used for direct control or observation of the physical layer radio blocks of the ADF7023. The contents of the MCR are not retained in the `PHY_SLEEP` state.

**PROGRAM ROM**

The program ROM consists of 4 kB of nonvolatile memory. It contains the firmware code for radio control, packet management, and smart wake mode.

**PROGRAM RAM**

The program RAM consists of 2 kB of volatile memory. This memory space is used for software modules, such as AES encryption, IR calibration, and Reed Solomon coding, which are available from Analog Devices. The software modules are downloaded to the program RAM memory space over the SPI by the host processor. See the Downloadable Firmware Modules section for details on loading a firmware module to program RAM.

**PACKET RAM**

The packet RAM consists of 256 bytes of memory space. The first 16 bytes of this memory space are allocated for use by the on-chip processor. The remaining 240 bytes of this memory space are allocated for storage of data from valid received packets and packet data to be transmitted. The communications processor stores received payload data at the memory location indicated by the value of the RX\_BASE\_ADR register (Address 0x125), the receive address pointer. The value of the

TX\_BASE\_ADR register (Address 0x124), the transmit address pointer, determines the start address of data to be transmitted by the communications processor. This memory can be arbitrarily assigned to store single or multiple transmit or receive packets, with and without overlap. The RX\_BASE\_ADR value should be chosen to ensure that there is enough allocated packet RAM space for the maximum receiver payload length.

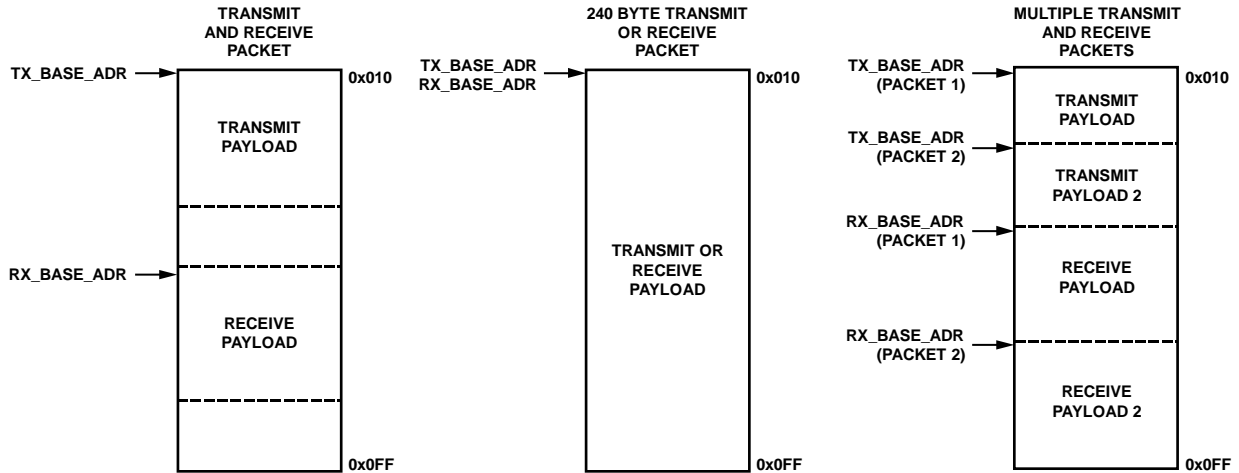

Figure 86. Example Packet RAM Configurations Using the Tx Packet and Rx Packet Address Pointers

08291-071

## SPI INTERFACE

### GENERAL CHARACTERISTICS

The ADF7023 is equipped with a 4-wire SPI interface, using the SCLK, MISO, MOSI, and  $\overline{CS}$  pins. The ADF7023 always acts as a slave to the host processor. Figure 87 shows an example connection diagram between the processor and the ADF7023. The diagram also shows the direction of the signal flow for each pin. The SPI interface is active, and the MISO outputs enabled, only while the  $\overline{CS}$  input is low. The interface uses a word length of eight bits, which is compatible with the SPI hardware of most processors. The data transfer through the SPI interface occurs with the most significant bit first. The MOSI input is sampled at the rising edge of SCLK. As commands or data are shifted in from the MOSI input at the SCLK rising edge, the status word or data is shifted out at the MISO pin synchronous with the SCLK clock falling edge. If  $\overline{CS}$  is brought low, the most significant bit of the status word appears on the MISO output without the need for a rising clock edge on the SCLK input.



Figure 87. SPI Interface Connections

### COMMAND ACCESS

The ADF7023 is controlled through commands. Command words are single octet instructions that control the state transitions of the communications processor and access to the registers and packet RAM. The complete list of valid commands is given in the Command Reference section. Commands that have a CMD prefix are handled by the communications processor. Memory access commands have an SPI prefix and are handled by an independent controller. Thus, SPI commands can be issued independent of the state of the communications processor.

A command is initiated by bringing  $\overline{CS}$  low and shifting in the command word over the SPI, as shown in Figure 88. All commands are executed on the last positive SCLK edge of the command. The  $\overline{CS}$  input must be brought high again after a command has been shifted into the ADF7023 to enable the recognition of successive command words. This is because a single command can be issued only during a  $\overline{CS}$  low period (with the exception of a double NOP command).



Figure 88. Command Write (No Parameters)

### STATUS WORD

The status word of the ADF7023 is automatically returned over the MISO each time a byte is transferred over the MOSI. Shifting in double SPI\_NOP commands (see Table 27) causes the status word to be shifted out as shown in Figure 89. The meaning of the various bit fields is illustrated in Table 25. The FW\_STATE variable can be used to read the current state of the communications processor and is described in Table 26. If it is busy performing an action or state transition, FW\_STATE is busy. The FW\_STATE variable also indicates the current state of the radio.

The SPI\_READY variable is used to indicate when the SPI is ready for access. The CMD\_READY variable is used to indicate when the communications processor is ready to accept a new command. The status word should be polled and the CMD\_READY bit examined before issuing a command to ensure that the communications processor is ready to accept a new command. It is not necessary to check the CMD\_READY bit before issuing a SPI memory access command. It is possible to queue one command while the communications processor is busy. This is discussed in the Command Queuing section.

The ADF7023 interrupt handler can be also be configured to generate an interrupt signal on IRQ\_GP3 when the communications processor is ready to accept a new command (CMD\_READY in the INTERRUPT\_SOURCE\_1 register (Address 0x337)) or when it has finished processing a command (CMD\_FINISHED in the INTERRUPT\_SOURCE\_1 register (Address 0x337)).

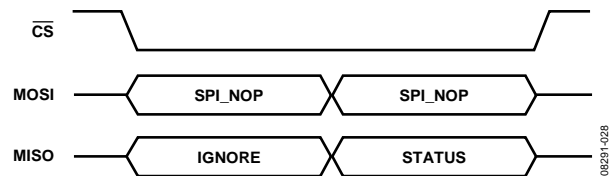

Figure 89. Reading the Status Word Using a Double SPI\_NOP Command

Table 25. Status Word

Bit	Name	Description
[7]	SPI_READY	0: SPI is not ready for access. 1: SPI is ready for access.
[6]	IRQ_STATUS	0: no pending interrupt condition. 1: pending interrupt condition (mirrors the IRQ_GP3 pin).
[5]	CMD_READY	0: the radio controller is not ready to receive a radio controller command. 1: the radio controller is ready to receive a radio controller command.
[4:0]	FW_STATE	Indicates the ADF7023 state (in Table 26).



**Table 26. FW\_STATE Description**

Value	State
0x0F	Initializing
0x00	Busy, performing a state transition
0x11	PHY_OFF
0x12	PHY_ON
0x13	PHY_RX
0x14	PHY_TX
0x06	PHY_SLEEP
0x05	Performing CMD_GET_RSSI
0x07	Performing CMD_IR_CAL
0x08	Performing CMD_AES_DECRYPT_INIT
0x09	Performing CMD_AES_DECRYPT
0x0A	Performing CMD_AES_ENCRYPT

**COMMAND QUEUING**

The CMD\_READY status bit is used to indicate that the command queue used by the communications processor is empty. The queue is one command deep. The FW\_STATE bit is used to indicate

the state of the communications processor. The operation of the status word and these bits is illustrated in Figure 90 when a CMD\_PHY\_ON command is issued in the PHY\_OFF state.

Operation of the status word when a command is being queued is illustrated in Figure 91 when a CMD\_PHY\_ON command is issued in the PHY\_OFF state followed quickly by a CMD\_PHY\_RX command. The CMD\_PHY\_RX command is issued while FW\_STATE is busy (that is, transitioning between the PHY\_OFF and PHY\_ON states) but the CMD\_READY bit is high, indicating that the command queue is empty. After the CMD\_PHY\_RX command is issued, the CMD\_READY bit transitions to a logic low, indicating that the command queue is full. After the PHY\_OFF to PHY\_ON transition is finished, the PHY\_RX command is processed immediately by the communications processor, and the CMD\_READY bit goes high, indicating that the command queue is empty and another command can be issued.

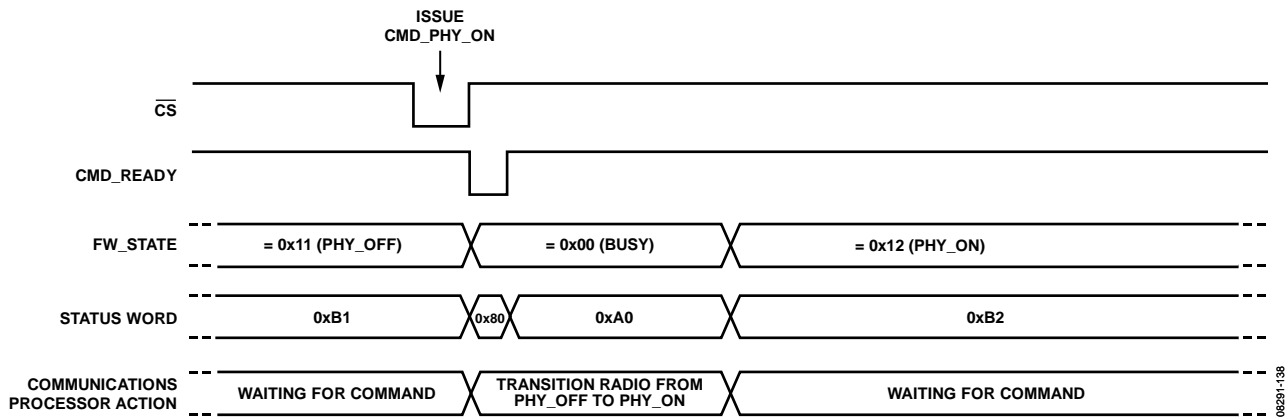

Figure 90. Operation of the CMD\_READY and FW\_STATE Bits in Transitioning the ADF7023 from the PHY\_OFF State to the PHY\_ON State

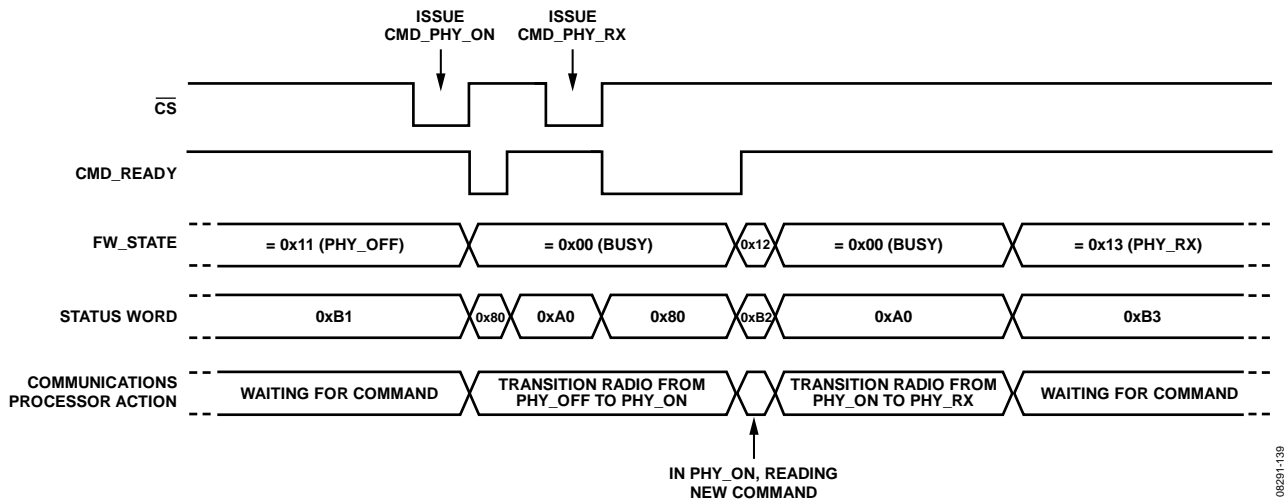

Figure 91. Command Queuing and Operation of the CMD\_READY and FW\_STATE Bits in Transitioning the ADF7023 from the PHY\_OFF State to the PHY\_ON State and Then to the PHY\_RX State

**MEMORY ACCESS**

Memory locations are accessed by invoking the relevant SPI command. An 11-bit address is used to identify registers or locations in the memory space. The most significant three bits of the address are incorporated into the SPI command by appending them as the LSBs of the command word. Figure 92 illustrates command, address, and data partitioning. The various SPI memory access commands are different, depending on the memory location being accessed (see Table 27).

An SPI command should be issued only if the SPI\_READY bit in the INTERRUPT\_SOURCE\_1 register (Address 0x337) of the status word bit is high. The ADF7023 interrupt handler can be also be configured to generate an interrupt signal on IRQ\_GP3 when the SPI\_READY bit is high.

An SPI command should not be issued while the communications processor is initializing (FW\_STATE = 0x0F). SPI commands can be issued in any other communications processor state, including the busy state (FW\_STATE = 0x00). This allows the ADF7023 memory to be accessed while the radio is transitioning between states.

**Block Write**

MCR, BBRAM, and packet RAM memory locations can be written to in block format using the SPI\_MEM\_WR command. The SPI\_MEM\_WR command code is 00011xxx, where xxx represent Bits[10:8] of the first 11-bit address. If more than one data byte is written, the write address is automatically incremented for every byte sent until CS is set high, which terminates the memory access command (see Figure 93 for more details). The maximum block write for the MCR, packet RAM, and BBRAM memories is 256 bytes, 256 bytes, and 64 bytes, respectively. These maximum block-write lengths should not be exceeded.

**Example**

Write 0x00 to the ADC\_CONFIG\_HIGH register (Address 0x35A).

- The first five bits of the SPI\_MEM\_WR command are 00011.
- The 11-bit address of ADC\_CONFIG\_HIGH is 01101011010.
- The first byte sent is 00011011 or 0x1B.
- The second byte sent is 01011010 or 0x5A.
- The third byte sent is 0x00.

Thus, 0x1B, 0x5A, 0x00 is written to the part.

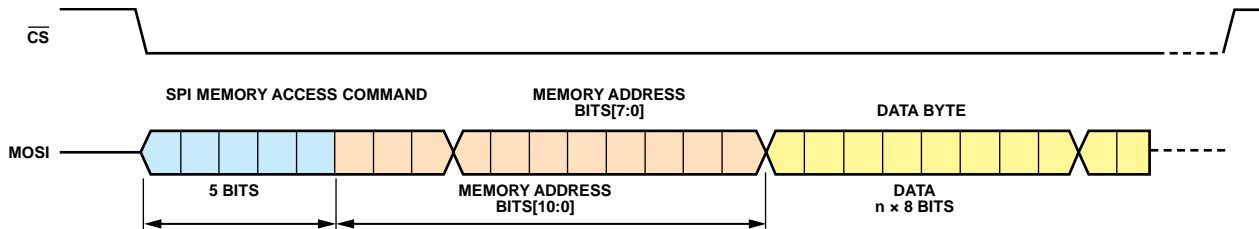

Figure 92. SPI Memory Access Command/Address Format

Table 27. Summary of SPI Memory Access Commands

SPI Command	Command Value	Description
SPI_MEM_WR	0x18 (packet RAM) 0x19 (BBRAM) 0x1B (MCR) 0x1E (program RAM)	Write data to BBRAM, MCR, or packet RAM sequentially. An 11-bit address is used to identify memory locations. The most significant three bits of the address are incorporated into the command (xxx). This command is followed by the remaining eight bits of the address.
SPI_MEM_RD	0x38 (packet RAM) 0x39 (BBRAM) 0x3B (MCR)	Read data from BBRAM, MCR, or packet RAM sequentially. An 11-bit address is used to identify memory locations. The most significant three bits of the address are incorporated into the command (xxx). This command is followed by the remaining eight bits of the address, which is subsequently followed by the appropriate number of SPI_NOP commands.
SPI_MEMR_WR	0x08 (packet RAM) 0x09 (BBRAM) 0x0B (MCR)	Write data to BBRAM, MCR, or packet RAM nonsequentially.
SPI_MEMR_RD	0x28 (packet RAM) 0x29 (BBRAM) 0x2B (MCR)	Read data from BBRAM, MCR, or packet RAM nonsequentially.
SPI_NOP	0xFF	No operation. Use for dummy writes when polling the status word. Also used as dummy data on the MOSI line when performing a memory read.

**Random Address Write**

MCR, BBRAM, and packet RAM memory locations can be written to in a nonsequential manner using the SPI\_MEMR\_WR command. The SPI\_MEMR\_WR command code is 00001xxxxb, where xxxb represent Bits[10:8] of the 11-bit address. The lower eight bits of the address should follow this command and then the data byte to be written to the address. The lower eight bits of the next address are entered, followed by the data for that address until all required addresses within that block are written, as shown in Figure 94.

**Program RAM Write**

The program RAM can be written to only by using the memory block write, as illustrated in Figure 93. SPI\_MEM\_WR should be set to 0x1E. See the Downloadable Firmware Modules section for details on loading a firmware module to program RAM.

**Block Read**

MCR, BBRAM, and packet RAM memory locations can be read from in block format using the SPI\_MEM\_RD command. The SPI\_MEM\_RD command code is 00111xxxxb, where xxxb represent Bits[10:8] of the first 11-bit address. This command is followed by the remaining eight bits of the address to be read and then two SPI\_NOP commands (dummy byte). The first byte available after writing the address should be ignored, with the second byte constituting valid data. If more than one data byte is to be read, the write address is automatically incremented for subsequent SPI\_NOP commands sent. See Figure 95 for more details.

**Random Address Read**

MCR, BBRAM, and packet RAM memory locations can be read from memory in a nonsequential manner using the SPI\_MEMR\_RD command. The SPI\_MEMR\_RD command code is 00101xxxxb, where xxxb represent Bits[10:8] of the 11-bit address. This command is followed by the remaining eight bits of the address to be written. Each subsequent address byte is then written. The last address byte to be written should be followed by two SPI\_NOP commands, as shown in Figure 96. The data bytes from memory, starting at the first address location, are available after the second status byte.

**Example**

Read the value stored in the ADC\_CONFIG\_HIGH register.

- The first five bits of the SPI\_MEM\_RD command are 00111.
- The 11-bit address of ADC\_CONFIG\_HIGH is 01101011010.
- The first byte sent is 00111011 or 0x3B.
- The second byte sent is 01011010 or 0x5A.
- The third byte sent is 0xFF (SPI\_NOP).
- The fourth byte sent is 0xFF.

Thus, 0x3B5AFFFF is written to the part.

The value shifted out on the MISO line while the fourth byte is sent is the value stored in the ADC\_CONFIG\_HIGH register.

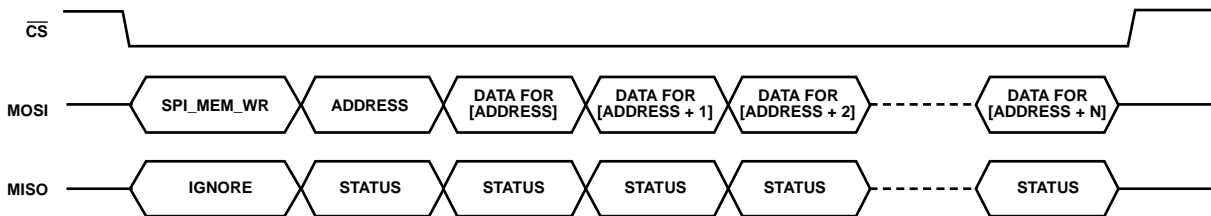

Figure 93. Memory (MCR, BBRAM, or Packet RAM) Block Write

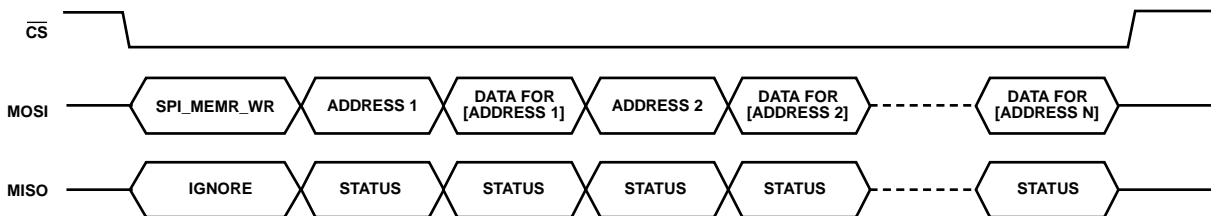

Figure 94. Memory (MCR, BBRAM, or Packet RAM) Random Address Write

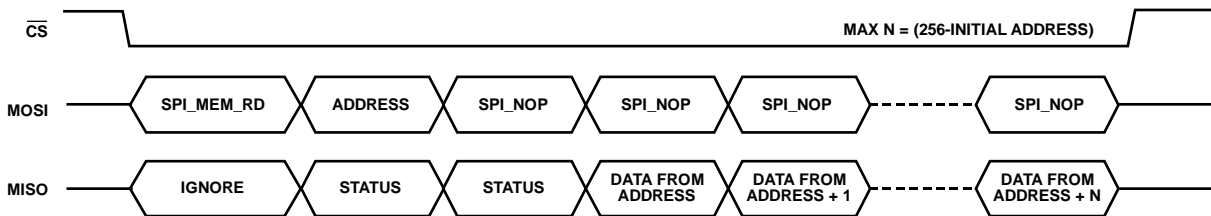

Figure 95. Memory (MCR, BBRAM, or Packet RAM) Block Read

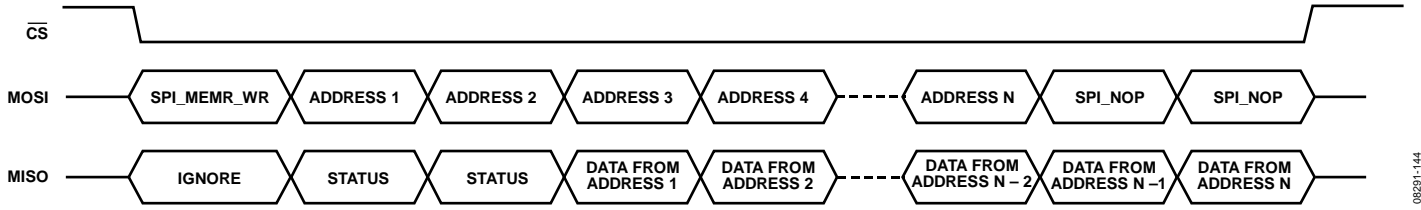

Figure 96. Memory (MCR, BBRAM, or Packet RAM) Random Address Read

06291-144

## LOW POWER MODES

The ADF7023 can be configured to operate in a broad range of energy sensitive applications where battery lifetime is critical. This includes support for applications where the ADF7023 is required to operate in a fully autonomous mode or applications where the host processor controls the transceiver during low power mode operation. These low power modes are implemented using a hardware wake-up controller (WUC), a firmware timer, and the smart wake mode functionality of the on-chip communications processor. The hardware WUC is a low power wake-up controller (WUC) that comprises a 16-bit wake-up timer with a programmable prescaler. The 32.768 kHz RCOSC or XOSC provides the clock source for the timer.

The firmware timer is a software timer residing on the ADF7023. The firmware timer is used to count the number of WUC timeouts and so can be used to count the number of ADF7023 wake-ups. The WUC and the firmware timer, therefore, provide a real-time clock capability.

Using the low power WUC and the firmware timer, the SWM firmware allows the ADF7023 to wake up autonomously from sleep without intervention from the host processor. During this wake-up period, the ADF7023 is controlled by the communications processor. This functionality allows carrier sense, packet sniffing, and packet reception while the host processor is in sleep, thereby dramatically reducing overall system current consumption. The smart wake mode can then wake the host processor on an interrupt condition. An overview of the low power mode configuration is shown in Figure 97, and the register settings that are used for the various low power modes are described in Table 28.

**Table 28. Settings for Low Power Modes**

Low Power Mode	Memory Address	Register Name	Bit	Description
Deep Sleep Modes	0x30D <sup>1</sup>	WUC_CONFIG_LOW	WUC_BBRAM_EN	0: BBRAM contents are not retained during PHY_SLEEP. 1: BBRAM contents are retained during PHY_SLEEP.
WUC	0x30C <sup>1</sup>	WUC_CONFIG_HIGH	WUC_PRESCALER[2:0]	Sets the prescaler value of the WUC.
WUC	0x30D <sup>1</sup>	WUC_CONFIG_LOW	WUC_RCOSC_EN	Enables the 32.768 kHz RC OSC.
WUC	0x30D <sup>1</sup>	WUC_CONFIG_LOW	WUC_XOSC32K_EN	Enables the 32.768 kHz external OSC.
WUC	0x30D <sup>1</sup>	WUC_CONFIG_LOW	WUC_CLKSEL	Sets the WUC clock source. 1: RC OSC selected. 2: XOSC selected.
WUC	0x30D <sup>1</sup>	WUC_CONFIG_LOW	WUC_ARM	Enable to ensure that the device wakes from the PHY_SLEEP state on a WUC timeout.
WUC	0x30E <sup>2</sup> , 0x30F	WUC_VALUE_HIGH WUC_VALUE_LOW	WUC_TIMER_VALUE[15:0]	The WUC timer value. $WUC\ Interval(s) = WUC\_TIMER\_VALUE \times \frac{2^{(WUC\_PRESCALER + 1)}}{32,768}$
WUC	0x101	INTERRUPT_MASK_1	WUC_TIMEOUT	Enables the interrupt on a WUC timeout.
Firmware Timer	0x100	INTERRUPT_MASK_0	INTERRUPT_NUM_WAKEUPS	Enabling this interrupt enables the firmware timer. Interrupt is set when the NUMBER_OF_WAKEUPS count exceeds the threshold.
Firmware Timer	0x102, 0x103	NUMBER_OF_WAKEUPS_0 NUMBER_OF_WAKEUPS_1	NUMBER_OF_WAKEUPS[15:0]	Number of ADF7023 wake-ups.
Firmware Timer	0x104, 0x105	NUMBER_OF_WAKEUPS_IRQ_THRESHOLD_0 NUMBER_OF_WAKEUPS_IRQ_THRESHOLD_1	NUMBER_OF_WAKEUPS_IRQ_THRESHOLD[15:0]	Threshold for the number of ADF7023 wake-ups. When exceeded, the ADF7023 exits low power mode.
SWM	0x11A	MODE_CONTROL	SWM_EN	Enables smart wake mode.
SWM	0x11A	MODE_CONTROL	SWM_RSSI_QUAL	Enables RSSI prequalification in smart wake mode.

Low Power Mode	Memory Address	Register Name	Bit	Description
SWM	0x108	SWM_RSSI_THRESH	SWM_RSSI_THRESH[7:0]	RSSI threshold for RSSI prequalification. RSSI threshold (dBm) = SWM_RSSI_THRESH – 107.
SWM	0x107	PARMTIME_DIVIDER	PARMTIME_DIVIDER[7:0]	Tick rate for the Rx dwell timer.
SWM	0x106	RX_DWELL_TIME	RX_DWELL_TIME[7:0]	Time that the ADF7023 remains awake during SWM. <i>Receive Dwell Time</i> = $RX\_DWELL\_TIME \times \frac{6.5 \text{ MHz}}{128 \times PARMTIME\_DIVIDER}$
SWM	0x100	INTERRUPT_MASK_0	INTERRUPT_SWM_RSSI_DET INTERRUPT_PREAMBLE_DETECT INTERRUPT_SYNC_DETECT INTERRUPT_ADDRESS_MATCH	Various interrupts that can be used in SWM.

<sup>1</sup> It is necessary to write to the 0x30C and 0x30D registers in the following order: WUC\_CONFIG\_HIGH (Address 0x30C), directly followed by writing to WUC\_CONFIG\_LOW (Address 0x30D).

<sup>2</sup> It is necessary to write to the 0x30E and 0x30F registers in the following order: WUC\_VALUE\_HIGH (Address 0x30E), directly followed by writing to WUC\_VALUE\_LOW (Address 0x30F).

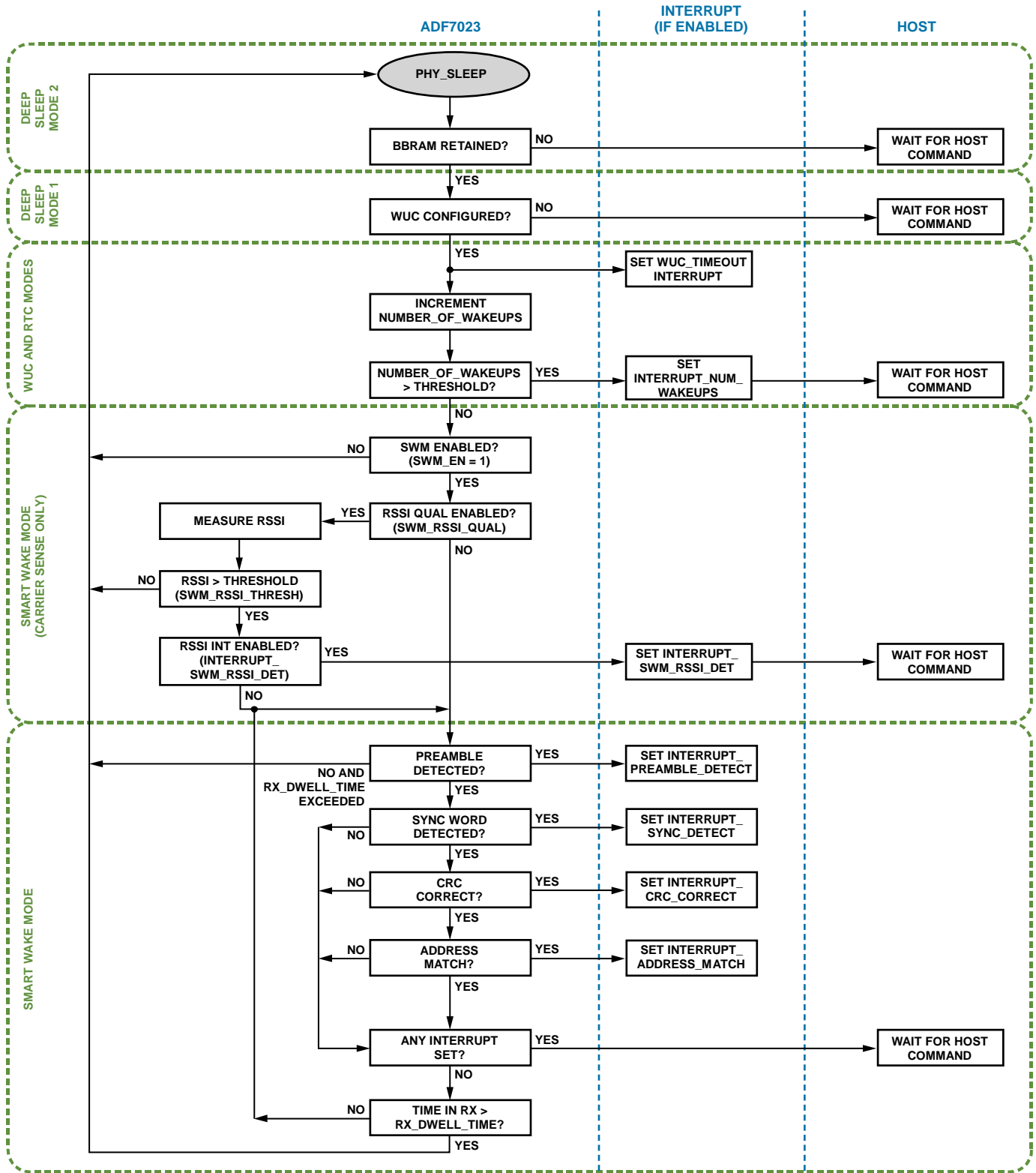

Figure 97. Low Power Mode Operation

08291-1-145

## EXAMPLE LOW POWER MODES

### Deep Sleep Mode 2

Deep Sleep Mode 2 is suitable for applications where the host processor controls the low power mode timing and the lowest possible ADF7023 sleep current is required.

In this low power mode, the ADF7023 is in the PHY\_SLEEP state. The BBRAM contents are not retained. This low power mode is entered by issuing the CMD\_HW\_RESET command from any radio state. To wake the part from the PHY\_SLEEP state, the  $\overline{CS}$  pin should be set low. The initialization routine after a CMD\_HW\_RESET command should be followed as detailed in the Radio Control section.

### Deep Sleep Mode 1

Deep Sleep Mode 1 is suitable for applications where the host processor controls the low power mode timing and the ADF7023 configuration is retained during the PHY\_SLEEP state.

In this low power mode, the ADF7023 is in the PHY\_SLEEP state with the BBRAM contents retained. Before entering the PHY\_SLEEP state, set WUC\_BBRAM\_EN (Address 0x30D) to 1 to ensure that the BBRAM is retained. This low power mode is entered by issuing the CMD\_PHY\_SLEEP command from either the PHY\_OFF or PHY\_ON state. To exit the PHY\_SLEEP state, the  $\overline{CS}$  pin can be set low. Then, follow the  $\overline{CS}$  low initialization routine, as detailed in the Radio Control section.

### WUC Mode

In this low power mode, the hardware WUC is used to wake the ADF7023 from the PHY\_SLEEP state after a user-defined duration. At the end of this duration, the ADF7023 can provide an interrupt to the host processor. While the ADF7023 is in the PHY\_SLEEP state, the host processor can optionally be in a deep sleep state to save power.

Before issuing the CMD\_PHY\_SLEEP command, the host processor should configure the WUC and set the firmware timer threshold to zero (NUMBER\_OF\_WAKEUPS\_IRQ\_THRESHOLD = 0, Address 0x104 and Address 0x105). The WUC\_BBRAM\_EN (Address 0x30D) should be set to 1 to ensure that the BBRAM is retained. On issuing the CMD\_PHY\_SLEEP command, the device goes to sleep for a period until the hardware timer times out. At this point, the device wakes up, and, if WUC\_TIMEOUT or INTERRUPT\_NUM\_WAKEUPS interrupts are enabled (Address 0x100), the device asserts the IRQ\_GP3 pin.

The operation of this low power mode is illustrated in Figure 98.

### WUC Mode with Firmware Timer

In this low power mode, the WUC is used to periodically wake the ADF7023 from the PHY\_SLEEP state, and the firmware timer is used to count the number of WUC timeouts. The combination of the WUC and the firmware timer provides a real-time clock (RTC) capability.

The host processor should set up the WUC and the firmware timer before entering the PHY\_SLEEP state. The WUC\_BBRAM\_EN (Address 0x30D) should be set to 1 to ensure that the BBRAM is retained. The WUC can be configured to time out at some standard time interval (for example, 1 sec, 60 sec). On issuing the CMD\_PHY\_SLEEP command, the device enters the PHY\_SLEEP state for a period until the hardware timer times out. At this point, the device wakes up, increments the 16-bit firmware timer (NUMBER\_OF\_WAKEUPS, Address 0x102 and Address 0x103) and, if WUC\_TIMEOUT is enabled (Address 0x101), the device asserts the IRQ\_GP3 pin. If the 16-bit firmware count is less than or equal to the user set threshold (NUMBER\_OF\_WAKEUPS\_IRQ\_THRESHOLD, Address 0x104 and Address 0x105), the device returns to the PHY\_SLEEP state. With this method, the firmware count (NUMBER\_OF\_WAKEUPS) equates to a real time interval.

When the firmware count exceeds the user-set threshold (NUMBER\_OF\_WAKEUPS\_IRQ\_THRESHOLD), the ADF7023 asserts the IRQ\_GP3 pin, if the INTERRUPT\_NUM\_WAKEUPS bit (Address 0x100) is set, and enters the PHY\_OFF state. The operation of this low power mode is illustrated in Figure 99.

### Smart Wake Mode (Carrier Sense Only)

In this low power mode, the WUC, firmware timer, and smart wake mode are used to implement periodic RSSI measurements on a particular channel (that is, carrier sense). To enable this mode, the WUC and firmware timer should be configured before entering the PHY\_SLEEP state. The WUC\_BBRAM\_EN (Address 0x30D) should be set to 1 to ensure that the BBRAM is retained. The RSSI measurement is enabled by setting SWM\_RSSI\_QUAL = 1 and SWM\_EN = 1 (Address 0x11A). INTERRUPT\_SWM\_RSSI\_DET (Address 0x100) should also be enabled. If the measured RSSI value is below the user-defined threshold set in the SWM\_RSSI\_THRESH register (Address 0x108), the device returns to the PHY\_SLEEP state. If the RSSI measurement is greater than the SWM\_RSSI\_THRESH value, the device sets the INTERRUPT\_SWM\_RSSI\_DET interrupt to alert the host processor and waits in the PHY\_ON state for a host command. The operation of this low power mode is illustrated in Figure 100.



**Smart Wake Mode**

In this low power mode the WUC, firmware timer, and smart wake mode are employed to periodically listen for packets. To enable this mode, the WUC and firmware timer should be configured and smart wake mode (SWM) enabled (SWM\_EN, Address 0x11A) before entering the PHY\_SLEEP state. The WUC\_BBRAM\_EN (Address 0x30D) should be set to 1 to ensure that the BBRAM is retained. RSSI prequalification can be optionally enabled (SWM\_RSSI\_QUAL = 1, Address 0x11A). When RSSI prequalification is enabled, the ADF7023 begins searching for the preamble only if the RSSI measurement is greater than the user-defined threshold.

The ADF7023 is in the PHY\_RX state for a duration determined by the RX\_DWELL\_TIME setting (Address 0x106). If the ADF7023 detects the preamble during the receive dwell time, it searches for the sync word. If the sync word routine is detected, the ADF7023 loads the received data to packet RAM and checks for a CRC and address match, if enabled. If any of the receive packet interrupts has been set, the ADF7023 returns to the PHY\_ON state and waits for a host command.

If the ADF7023 receives preamble detection during the receive dwell time but the remainder of the received packet extends beyond the dwell time, the ADF7023 extends the dwell time

until all of the packet is received or the packet is recognized as invalid (for example, there is an incorrect sync word).

This low power mode terminates when a valid packet interrupt is received. Alternatively, this low power mode can be terminated via a firmware timer timeout. This can be useful if certain radio tasks (for example, IR calibration) or processor tasks must be run periodically while in the low power mode.

The operation of this low power mode is illustrated in Figure 101.

**Exiting Low Power Mode**

As described in Figure 97, the ADF7023 waits for a host command on any of the termination conditions of the low power mode. It is also possible to perform an asynchronous exit from low power mode using the following procedure:

1. Bring the  $\overline{\text{CS}}$  pin of the SPI low and wait until the MISO output goes high.
2. Issue a CMD\_HW\_RESET command.

The host processor should then follow the initialization procedure after a CMD\_HW\_RESET command, as described in the Initialization section.

LOW POWER MODE TIMING DIAGRAMS



Figure 98. Low Power Mode Timing When Using the WUC

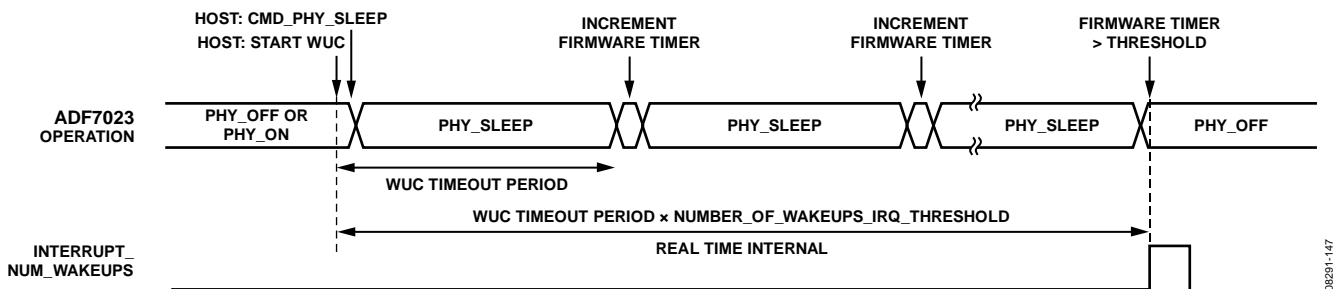

Figure 99. Low Power Mode Timing When Using the WUC and the Firmware Timer

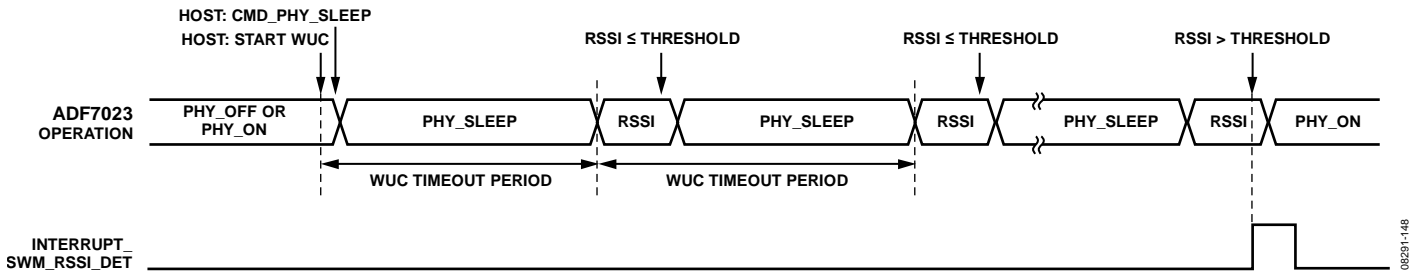

Figure 100. Low Power Mode Timing When Using the WUC, Firmware Timer, and SWM with Carrier Sense

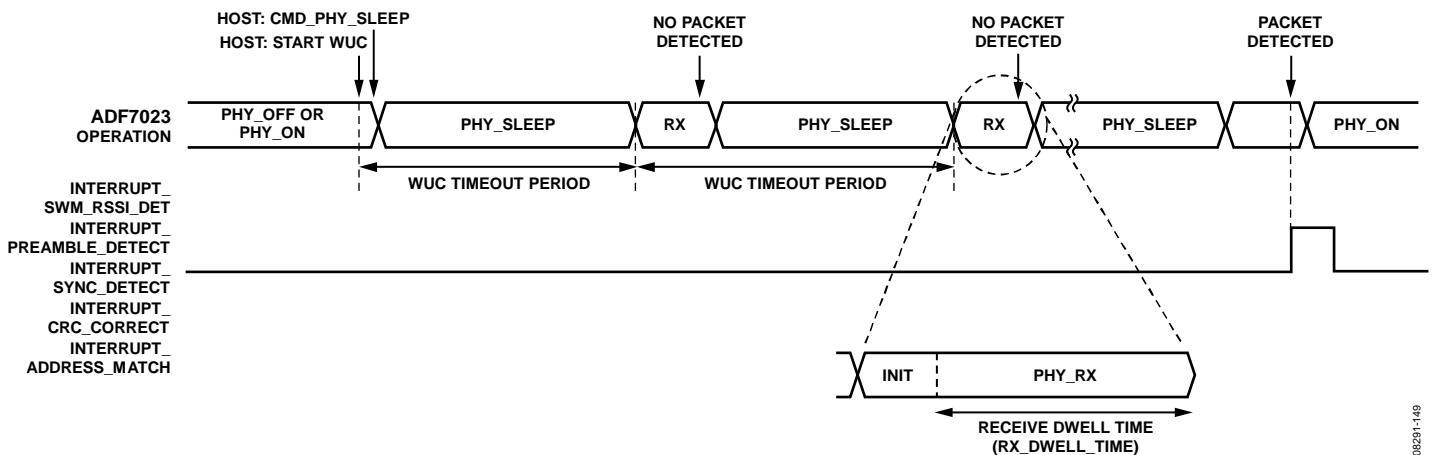

Figure 101. Low Power Mode Timing When Using the WUC, Firmware Timer, and SWM

## WUC SETUP

### Circuit Description

The ADF7023 features a low power wake-up controller comprising a 16-bit wake-up timer with a 3-bit programmable prescaler, as illustrated in Figure 102. The prescaler clock source can be configured to use either the 32.76 kHz internal RC oscillator (RCOSC) or the 32.76 kHz external oscillator (XOSC). This combination of programmable prescaler and 16-bit down counter gives a total hardware timer range of 30.52  $\mu$ s to 36.4 hours.

### Configuration and Operation

The hardware WUC is configured via the following registers:

- WUC\_CONFIG\_HIGH (Address 0x30C)
- WUC\_CONFIG\_LOW (Address 0x30D)
- WUC\_VALUE\_HIGH (Address 0x30E)
- WUC\_VALUE\_LOW (Address 0x30F)

The relevant fields of each register are detailed in Table 29. All four of these registers are write only.

The WUC should be configured as follows:

1. Clear all interrupts.
2. Set required interrupts.
3. Write to WUC\_CONFIG\_HIGH and WUC\_CONFIG\_LOW. Ensure that WUC\_ARM = 1. Ensure that WUC\_CONFIG\_BBRAM\_EN = 1 (retain BBRAM during PHY\_SLEEP). It is necessary to write to both registers together in the following order: WUC\_CONFIG\_HIGH directly followed by writing to WUC\_CONFIG\_LOW.
4. Write to WUC\_VALUE\_HIGH and WUC\_VALUE\_LOW. This configures the WUC\_TIMER\_VALUE[15:0] and, thus, the WUC timeout period. The timer begins counting from the configured value after these registers have been written to. It is necessary to write to both registers together in the following order: WUC\_TIMER\_VALUE\_HIGH directly followed by writing to WUC\_VALUE\_LOW.



Figure 102. Hardware Wake-Up Controller (WUC)

08291-150

Table 29. WUC Register Settings

WUC Setting	Name	Description																																	
WUC_VALUE_HIGH [7:0]	WUC_TIMER_VALUE[15:8]	WUC timer value. $WUC\ Interval(s) = WUC\_TIMER\_VALUE \times \frac{2^{(WUC\_PRESCALER + 1)}}{32,768}$																																	
WUC_VALUE_LOW[7:0]	WUC_TIMER_VALUE[7:0]	WUC timer value.																																	
WUC_CONFIG_HIGH[7]	Reserved	Set to 0.																																	
WUC_CONFIG_HIGH[6:3]	RCOSC_COARSE_CAL_VALUE	<table border="1"> <thead> <tr> <th>RCOSC_COARSE_CAL_VALUE</th> <th>Change in RC Oscillator Frequency</th> <th>Coarse Tune State</th> </tr> </thead> <tbody> <tr><td>0000</td><td>+83%</td><td>State 10</td></tr> <tr><td>0001</td><td>+66%</td><td>State 9</td></tr> <tr><td>1000</td><td>+50%</td><td>State 8</td></tr> <tr><td>1001</td><td>+33%</td><td>State 7</td></tr> <tr><td>1100</td><td>+16%</td><td>State 6</td></tr> <tr><td>1101</td><td>0%</td><td>State 5</td></tr> <tr><td>1110</td><td>-16%</td><td>State 4</td></tr> <tr><td>1111</td><td>-33%</td><td>State 3</td></tr> <tr><td>0110</td><td>-50%</td><td>State 2</td></tr> <tr><td>0111</td><td>-66%</td><td>State 1</td></tr> </tbody> </table>	RCOSC_COARSE_CAL_VALUE	Change in RC Oscillator Frequency	Coarse Tune State	0000	+83%	State 10	0001	+66%	State 9	1000	+50%	State 8	1001	+33%	State 7	1100	+16%	State 6	1101	0%	State 5	1110	-16%	State 4	1111	-33%	State 3	0110	-50%	State 2	0111	-66%	State 1
RCOSC_COARSE_CAL_VALUE	Change in RC Oscillator Frequency	Coarse Tune State																																	
0000	+83%	State 10																																	
0001	+66%	State 9																																	
1000	+50%	State 8																																	
1001	+33%	State 7																																	
1100	+16%	State 6																																	
1101	0%	State 5																																	
1110	-16%	State 4																																	
1111	-33%	State 3																																	
0110	-50%	State 2																																	
0111	-66%	State 1																																	
WUC_CONFIG_HIGH[2:0]	WUC_PRESCALER	<table border="1"> <thead> <tr> <th>WUC_PRESCALER</th> <th>32.768 kHz Divider</th> <th>Tick Period</th> </tr> </thead> <tbody> <tr><td>000</td><td>1</td><td>30.52 μs</td></tr> <tr><td>001</td><td>4</td><td>122.1 μs</td></tr> <tr><td>010</td><td>8</td><td>244.1 μs</td></tr> <tr><td>011</td><td>16</td><td>488.3 μs</td></tr> <tr><td>100</td><td>128</td><td>3.91 ms</td></tr> <tr><td>101</td><td>1024</td><td>31.25 ms</td></tr> <tr><td>110</td><td>8192</td><td>250 ms</td></tr> <tr><td>111</td><td>65,536</td><td>2000 ms</td></tr> </tbody> </table>	WUC_PRESCALER	32.768 kHz Divider	Tick Period	000	1	30.52 μs	001	4	122.1 μs	010	8	244.1 μs	011	16	488.3 μs	100	128	3.91 ms	101	1024	31.25 ms	110	8192	250 ms	111	65,536	2000 ms						
WUC_PRESCALER	32.768 kHz Divider	Tick Period																																	
000	1	30.52 μs																																	
001	4	122.1 μs																																	
010	8	244.1 μs																																	
011	16	488.3 μs																																	
100	128	3.91 ms																																	
101	1024	31.25 ms																																	
110	8192	250 ms																																	
111	65,536	2000 ms																																	
WUC_CONFIG_LOW[7]	Reserved	Set to 0.																																	
WUC_CONFIG_LOW[6]	WUC_RCOSC_EN	1: enable. 0: disable RCOSC32K.																																	
WUC_CONFIG_LOW[5]	WUC_XOSC32K_EN	1: enable. 0: disable XOSC32K.																																	
WUC_CONFIG_LOW[4]	WUC_CLKSEL	1: RC 32.768 kHz oscillator. 0: external crystal oscillator.																																	
WUC_CONFIG_LOW [3]	WUC_BBRAM_EN	1: enable power to BBRAM during the PHY_SLEEP state. 0: disable power to BBRAM during the PHY_SLEEP state.																																	
WUC_CONFIG_LOW[2:1]	Reserved	Set to 0.																																	
WUC_CONFIG_LOW[0]	WUC_ARM	1: enable wake-up on WUC timeout event. 0: disable wake-up on WUC timeout event.																																	

## FIRMWARE TIMER SETUP

The ADF7023 wakes up from the PHY\_SLEEP state at the rate set by the WUC. A firmware timer, implemented by the on-chip processor, can be used to count the number of hardware wake-ups and generate an interrupt to the host processor. Thus, the ADF7023 can be used to handle the wake-up timing of the host processor, reducing overall system power consumption.

To set up the firmware timer, the host processor must set a value in the NUMBER\_OF\_WAKEUPS\_IRQ\_THRESHOLD [15:0] registers (Address 0x104 and Address 0x105). This 16-bit value represents the number of times the device wakes up before it interrupts the host processor. At each wake-up, the ADF7023 increments the NUMBER\_OF\_WAKEUPS[15:0] register (Address 0x103). If this value exceeds the value set by the NUMBER\_OF\_WAKEUPS\_IRQ\_THRESHOLD[15:0] register, the NUMBER\_OF\_WAKEUPS[15:0] value is cleared to 0. At this time, if the INTERRUPT\_NUM\_WAKEUPS bit in the INTERRUPT\_MASK\_0 register (Address 0x100) is set, the device asserts the IRQ\_GP3 pin and enters the PHY\_OFF state.

## CALIBRATING THE RC OSCILLATOR

There are two types of RC oscillator calibration, fine and coarse calibrations. A fine calibration of the RC oscillator is automatically performed upon wake up from PHY\_SLEEP and upon cold start. The user can also manually initiate a fine calibration.

To meet the quoted RC oscillator frequency accuracy given in the Specifications section, it is necessary to perform a coarse calibration of the RC oscillator.

## *Performing a Fine Calibration of the RC Oscillator*

This is performed as follows:

1. Write to the WUC\_CONFIG\_HIGH and WUC\_CONFIG\_LOW registers, setting the WUC\_RCOSC\_EN bit high.
2. Write a 0 to WUC\_RCOSC\_CAL\_EN in the WUC\_FLAG\_RESET register.
3. Write a 1 to WUC\_RCOSC\_CAL\_EN in the WUC\_FLAG\_RESET register.

During calibration, the host microprocessor can write to and read from memory locations and issue commands to the ADF7023. The RC oscillator calibration status can be viewed in the WUC\_STATUS register (Location 0x311).

The result of a fine calibration can be read back from the RCOSC\_CAL\_READBACK\_HIGH (Location 0x34F) and RCOSC\_CAL\_READBACK\_LOW (Location 0x350) registers. A fine calibration typically takes 1.5 ms.

## *Performing a Coarse Calibration of the RC Oscillator*

This calibration involves performing fine calibrations of the RC oscillator for different values of RCOSC\_COARSE\_CAL\_VALUE to determine the optimum value to be written to WUC\_CONFIG\_HIGH (Location 0x30C[6:3]).

The coarse calibration procedure is outlined in Figure 103. Typically, the optimum coarse tune state is State 5, and the algorithm starts in this state to minimize the number of iterations.

Usually, the optimum RCOSC\_COARSE\_CAL\_VALUE is determined at 25°C once, and the result stored in the host microprocessor. This result can be incorporated in the value written to WUC\_CONFIG\_HIGH prior to fine calibrations of the RC oscillator.

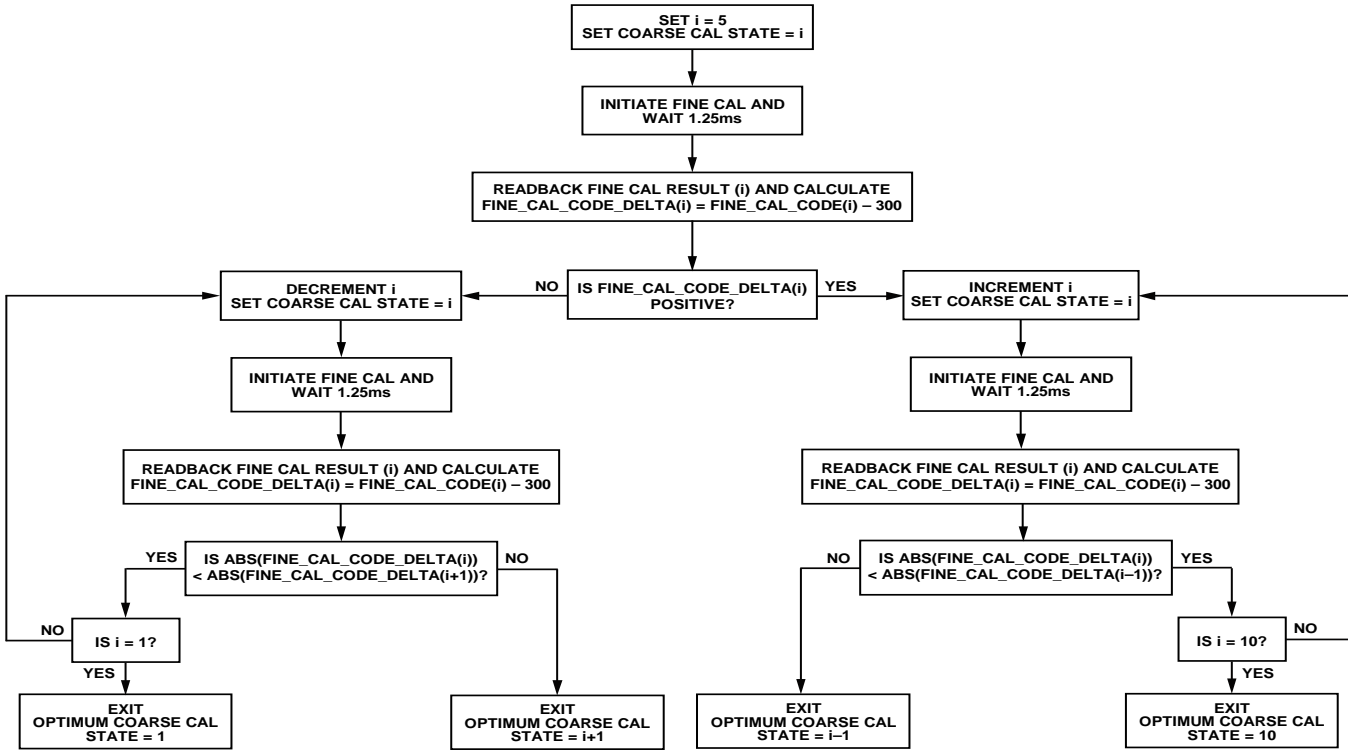

Figure 103. RC Oscillator Coarse Calibration Algorithm

08291-103

## DOWNLOADABLE FIRMWARE MODULES

The program RAM memory of the ADF7023 can be used to store firmware modules for the communications processor that provide the ADF7023 with extra functionality. The binary code for these firmware modules and detail on their functionality are available from Analog Devices. Three modules are briefly described in this section, namely, image rejection calibration, AES encryption and decryption, and Reed Solomon coding.

### WRITING A MODULE TO PROGRAM RAM

The sequence to write a firmware module to program RAM is as follows:

1. Ensure that the ADF7023 is in PHY\_OFF.
2. Issue the CMD\_RAM\_LOAD\_INIT command.
3. Write the module to program RAM using an SPI memory block write (see the SPI Interface section).
4. Issue the CMD\_RAM\_LOAD\_DONE command.

The firmware module is now stored on program RAM.

### IMAGE REJECTION CALIBRATION MODULE

The calibration system initially disables the ADF7023 receiver, and an internal RF source is applied to the RF input at the image frequency. The algorithm then maximizes the receiver image rejection performance by iteratively minimizing the quadrature gain and phase errors in the polyphase filter.

The calibration algorithm takes its initial estimates for quadrature phase correction (Address 0x118) and quadrature gain correction (Address 0x119) from BBRAM. After calibration, new optimum values of phase and gain are loaded back into these locations. These calibration values are maintained in BBRAM during sleep mode and are automatically reapplied from a wake-up event, which keeps the number of calibrations required to a minimum.

Depending on the initial values of quadrature gain and phase correction, the calibration algorithm can take approximately 20 ms to find the optimum image rejection performance. However, the calibration time can be significantly less than this when the seed values used for gain and phase correction are close to optimum.

The image rejection performance is also dependent on temperature. To maintain optimum image rejection performance, a calibration should be activated whenever a temperature change of more than 10°C occurs. The ADF7023 on-chip temperature sensor can be used to determine when the temperature exceeds this limit.

### REED SOLOMON CODING MODULE

This coding module uses Reed Solomon block coding to detect and correct errors in the received packet. A transmit message of  $k$  bytes in length, is appended with an error checking code (ECC) of length  $n - k$  bytes to give a total message length of  $n$  bytes, as shown in Figure 104.

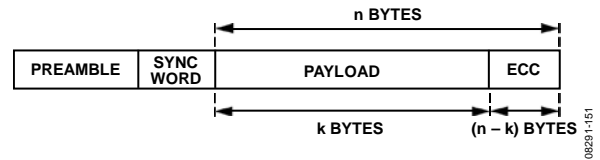

Figure 104. Packet Structure with Appended Reed Solomon Error Check Code (ECC)

The receiver decodes the ECC to detect and correct up to  $t$  bytes in error, where  $t = (n - k)/2$ . The firmware supports correction of up to five bytes in the  $n$  byte field. To correct  $t$  bytes in error, an ECC length of  $2t$  bytes is required, and the byte errors can be randomly distributed throughout the payload and ECC fields.

Reed Solomon coding exhibits excellent burst error correction capability and is commonly used to improve the robustness of a radio link in the presence of transient interference or due to rapid signal fading conditions that can corrupt sections of the message payload.

Reed Solomon coding is also capable of improving the receiver's sensitivity performance by several dB, where random errors tend to dominate under low SNR conditions and the receiver's packet error rate performance is limited by thermal noise.

The number of consecutive bit errors that can be 100% corrected is  $\{(t - 1) \times 8 + 1\}$ . Longer, random bit-error patterns, up to  $t$  bytes, can also be corrected if the error patterns start and end at byte boundaries.

The firmware also takes advantage of an on-chip hardware accelerator module to enhance throughput and minimize the latency of the Reed Solomon processing.

### AES ENCRYPTION AND DECRYPTION MODULE

The downloadable AES firmware module supports 128-bit block encryption and decryption with key sizes of 128 bits, 192 bits, and 256 bits. Two modes are supported: ECB mode and CBC Mode 1. ECB mode simply encrypts/decrypts on a 128-bit block by block with a single secret key as illustrated in Figure 105. CBC Mode 1 encrypts after first adding (Modulo 2), a 128-bit user supplied initialization vector. The resulting cipher text is then used as the initialization vector for the next block and so forth, as illustrated in Figure 106. Decryption provides the inverse functionality. The firmware also takes advantage of an on-chip hardware accelerator module to enhance throughput and minimize the latency of the AES processing.



Figure 105. ECB Mode.

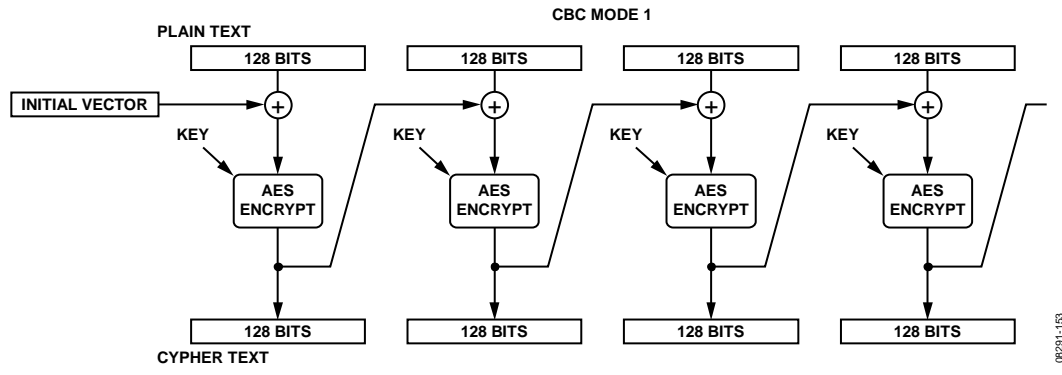

Figure 106. CBC Mode 1



## RADIO BLOCKS

### FREQUENCY SYNTHESIZER

A fully integrated RF frequency synthesizer is used to generate both the transmit signal and the receiver's local oscillator (LO) signal. The architecture of the frequency synthesizer is shown in Figure 107.

The receiver uses a fractional-N frequency synthesizer to generate the mixer's LO for down conversion to the intermediate frequency (IF) of 200 kHz or 300 kHz. In transmit mode, a high resolution sigma-delta ( $\Sigma$ - $\Delta$ ) modulator is used to generate the required frequency deviations at the RF output when FSK data is transmitted. To reduce the occupied FSK bandwidth, the transmitted bit stream can be filtered using a digital Gaussian filter, which is enabled via the RADIO\_CFG\_9 register (Address 0x115). The Gaussian filter uses a bandwidth time (BT) of 0.5.

The VCO and the PLL loop filter of the ADF7023 are fully integrated. To reduce the effect of pulling of the VCO by the power-up of the PA and to minimize spurious emissions, the VCO operates at twice or four times the RF frequency. The VCO signal is then divided by 2 or 4, giving the required frequency for the transmitter and the required LO frequency for the receiver.

A high speed, fully automatic calibration scheme is used to ensure that the frequency and amplitude characteristic of the VCO are maintained over temperature, supply voltage, and process variations.

The calibration is automatically performed when the CMD\_PHY\_RX or CMD\_PHY\_TX command is issued. The calibration duration is 142  $\mu$ s, and if required, the CALIBRATION\_STATUS register (Address 0x339) can be polled to indicate the completion of the VCO self-calibration. After the VCO is calibrated, the frequency synthesizer settles to within  $\pm 5$  ppm of the target frequency in 56  $\mu$ s.

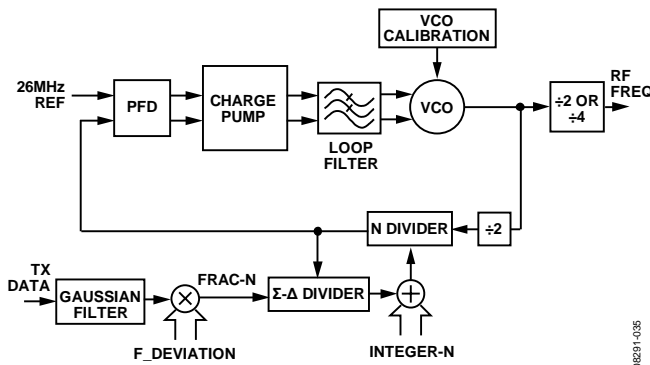

Figure 107. RF Frequency Synthesizer Architecture

### Synthesizer Bandwidth

The synthesizer loop filter is fully integrated on chip and has a programmable bandwidth. The communications processor automatically sets the bandwidth of the synthesizer when the device enters PHY\_TX or PHY\_RX state. On entering the PHY\_TX state, the communications processor chooses the bandwidth based on the programmed modulation scheme

(2FSK, GFSK, or OOK) and the data rate. This ensures optimum modulation quality for each data rate. On entering the PHY\_RX state, the communications processor sets a narrow bandwidth to ensure best receiver rejection. In all, there are eight bandwidth configurations. Each synthesizer bandwidth setting is described in Table 30.

Table 30. Automatic Synthesizer Bandwidth Selections

Description	Data Rate (kbps)	Closed Loop Synthesizer Bandwidth (kHz)
Rx 2FSK/GFSK/MSK/GMSK	All	92
Tx 2FSK/GFSK/MSK/GMSK	1 to 49.5	130
Tx 2FSK/GFSK/MSK/GMSK	49.6 to 99.1	174
Tx 2FSK/GFSK/MSK/GMSK	99.2 to 129.5	174
Tx 2FSK/GFSK/MSK/GMSK	129.6 to 179.1	226
Tx 2FSK/GFSK/MSK/GMSK	179.2 to 239.9	305
Tx 2FSK/GFSK/MSK/GMSK	240 to 300	382
Tx OOK	All	185

### Synthesizer Settling

After the VCO calibration, a 56  $\mu$ s delay is allowed for synthesizer settling. This delay is fixed at 56  $\mu$ s by default and ensures that the synthesizer has fully settled when using any of the default synthesizer bandwidths.

However, in some cases, it may be necessary to use a custom synthesizer settling delay. To use a custom delay, set the CUSTOM\_TRX\_SYNTH\_LOCK\_TIME EN bit to 1 in the MODE\_CONTROL register (Address 0x11A). The synthesizer settling delays for the PHY\_RX and PHY\_TX state transitions can be set independently in RX\_SYNTH\_LOCK\_TIME register (Address 0x13E) and the TX\_SYNTH\_LOCK\_TIME register (Address 0x13F). The settling time can be set in the range 2  $\mu$ s to 512  $\mu$ s in steps of 2  $\mu$ s.

### Bypassing VCO Calibration

It is possible to bypass the VCO calibration for ultrafast frequency hopping in transmit or receive. The calibration data for each RF channel should be stored in the host processor memory. The calibration data comprises two values: the VCO band select value and the VCO amplitude level.

### Read and Store Calibration Data

- Go to the PHY\_TX or PHY\_RX state without bypassing the VCO calibration.
- Read the following MCR registers and store the calibrated data in memory on the host processor:
  - VCO\_BAND\_READBACK (Address 0x3DA)
  - VCO\_AMPL\_READBACK (Address 0x3DB)

**Bypassing VCO Calibration on CMD\_PHY\_TX or CMD\_PHY\_RX**

1. Ensure that the BBRAM is configured.
2. Set VCO\_OVRW\_EN (Address 0x3CD) = 0x3.
3. Set VCO\_CAL\_CFG (Address 0x3D0) = 0x0F.
4. Set VCO\_BAND\_OVRW\_VAL (Address 0x3CB) = stored VCO\_BAND\_READBACK (Address 0x3DA) for that channel.
5. Set VCO\_AMPL\_OVRW\_VAL (Address 0x3CC) = stored VCO\_AMPL\_READBACK (Address 0x3DB) for that channel.
6. Set SYNTH\_CAL\_EN = 0 (in the CALIBRATION\_CONTROL register, Address 0x338).
7. Set SYNTH\_CAL\_EN = 1 (in the CALIBRATION\_CONTROL register, Address 0x338).
8. Issue CMD\_PHY\_TX or CMD\_PHY\_RX to go to the PHY\_TX or PHY\_RX state without the VCO calibration.

**CRYSTAL OSCILLATOR**

A 26 MHz crystal oscillator operating in parallel mode must be connected between the XOSC26P and XOSC26N pins. Two parallel loading capacitors are required for oscillation at the correct frequency. Their values are dependent upon the crystal specification. They should be chosen to ensure that the shunt value of capacitance added to the PCB track capacitance and the input pin capacitance of the ADF7023 equals the specified load capacitance of the crystal, usually 10 pF to 20 pF. Track capacitance values vary from 2 pF to 5 pF, depending on board layout. The total load capacitance is described by

$$C_{LOAD} = \frac{1}{\frac{1}{C_1} + \frac{1}{C_2}} + \frac{C_{PIN}}{2} + C_{PCB}$$

where:

$C_{LOAD}$  is the total load capacitance.

$C_1$  and  $C_2$  are the external crystal load capacitors.

$C_{PIN}$  is the ADF7023 input capacitance of the XOSC26P and XOSC26N pins and is equal to 2.1pF.

$C_{PCB}$  is the PCB track capacitance.

When possible, choose capacitors that have a very low temperature coefficient to ensure stable frequency operation over all conditions.

The crystal frequency error can be corrected by means of an integrated digital tuning varactor. For a typical crystal load capacitance of 10 pF, a tuning range of +15 ppm to -11.25 ppm is available via programming of a 3-bit DAC, according to Table 31. The 3-bit value should be written to XOSC\_CAP\_DAC in the OSC\_CONFIG register (Address 0x3D2).

Alternatively, any error in the RF frequency due to crystal error can be adjusted for by offsetting the RF channel frequency using the RF channel frequency setting in BBRAM memory.

**Table 31. Crystal Frequency Pulling Programming**

XOSC_CAP_DAC	Pulling (ppm)
000	+15
001	+11.25
010	+7.5
011	+3.75
100	0
101	-3.75
110	-7.5
111	-11.25

**MODULATION**

The ADF7023 supports binary frequency shift keying (2FSK), minimum shift keying (MSK), binary level Gaussian filtered 2FSK (GFSK), Gaussian filtered MSK (GMSK), and on-off keying (OOK). The desired transmit and receive modulation formats are set in the RADIO\_CFG\_9 register (Address 0x115).

When using 2FSK/GFSK/MSK/GMSK modulation, the frequency deviation can be set using the  $FREQ\_DEVIATION[11:0]$  parameter in the RADIO\_CFG\_1 register (Address 0x10D) and RADIO\_CFG\_1 register (Address 0x10E). The data rate can be set in the 1 kbps to 300 kbps range using the  $DATA\_RATE[11:0]$  parameter in the RADIO\_CFG\_0 register (Address 0x10C) and RADIO\_CFG\_1 register (Address 0x10D). For GFSK/GMSK modulation, the Gaussian filter uses a fixed bandwidth time (BT) product of 0.5.

When using OOK modulation, it is recommended to enable Manchester encoding ( $MANCHESTER\_ENC = 1$ , Address 0x11C). The data rate can be set in the 2.4 kbps to 19.2 kbps range (4.8 kcps to 38.4 kcps Manchester encoded) using the  $DATA\_RATE[11:0]$  parameter in the RADIO\_CFG\_0 register (Address 0x10C) and RADIO\_CFG\_1 register (Address 0x10D).

**RF OUTPUT STAGE**

**Power Amplifier (PA)**

The ADF7023 PA can be configured for single-ended or differential output operation using the  $PA\_SINGLE\_DIFF\_SEL$  bit in the RADIO\_CFG\_8 register (Address 0x114). The PA level is set by the  $PA\_LEVEL$  bit in the RADIO\_CFG\_8 register and has a range of 0 to 15. For finer control of the output power level, the  $PA\_LEVEL\_MCR$  register (Address 0x307) can be used. It offers more resolution with a setting range of 0 to 63. The relationship between the  $PA\_LEVEL$  and  $PA\_LEVEL\_MCR$  settings is given by

$$PA\_LEVEL\_MCR = 4 \times PA\_LEVEL + 3$$

The single-ended configuration can deliver 13.5 dBm output power. The differential PA can deliver 10 dBm output power and allows a straightforward interface to dipole antennae. The two PA configurations offer a Tx antenna diversity capability. Note that the two PAs cannot be enabled at the same time.

**Automatic PA Ramp**

The ADF7023 has built-in up and down PA ramping for both single-ended and differential PAs. There are eight ramp rate settings, with the ramp rate defined as a certain number of PA power level settings per data bit period. The PA\_RAMP variable in the RADIO\_CFG\_8 register (Address 0x114) sets this PA ramp rate, as illustrated in Figure 108.

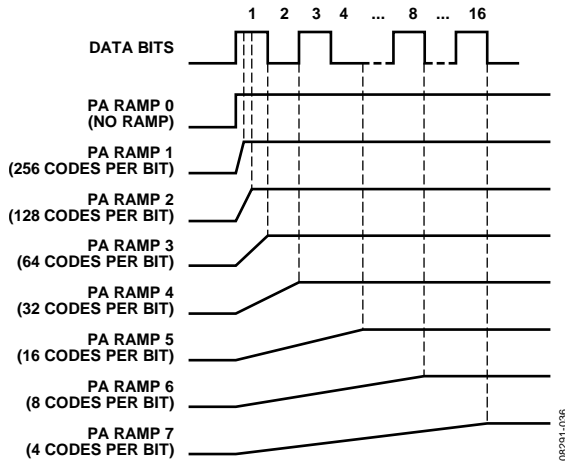

Figure 108. PA Ramp for Different PA\_RAMP Settings

The PA ramps to the level set by the PA\_LEVEL or PA\_LEVEL\_MCR settings. Enabling the PA ramp reduces spectral splatter and helps meet radio regulations (for example, the ETSI EN 300 220 standard), which limit PA transient spurious emissions. To ensure optimum performance, an adequately long PA ramp rate is required based on the data rate and the PA output power setting. The PA\_RAMP setting should, therefore, be set such that

$$\text{Ramp Rate (Codes/Bit)} \leq 10,000 \times \frac{\text{PA\_LEVEL\_MCR}[5:0]}{\text{DATA\_RATE}[11:0]}$$

where PA\_LEVEL\_MCR is related to the PA\_LEVEL setting by PA\_LEVEL\_MCR = 4 × PA\_LEVEL + 3.

**PA/LNA INTERFACE**

The ADF7023 supports both single-ended and differential PA outputs. Only one PA can be active at one time. The differential PA and LNA share the same pins, RFIO\_1P and RFIO\_1N, which facilitate a simpler antenna interface. The single-ended PA output is available on the RFO2 pin. A number of PA/LNA antenna matching options are possible and are described in the PA/LNA section.

**RECEIVE CHANNEL FILTER**

The receiver’s channel filter is a fourth order, active polyphase Butterworth filter with programmable bandwidths of 100 kHz, 150 kHz, 200 kHz, and 300 kHz. The fourth order filter gives very good interference suppression of adjacent and neighboring channels and also suppresses the image channel by approximately 36 dB at a 100 kHz IF bandwidth and an RF frequency of 868 MHz or 915 MHz.

For channel bandwidths of 100 kHz to 200 kHz, an IF frequency of 200 kHz is used, which results in an image frequency located 400 kHz below the wanted RF frequency. When the 300 kHz bandwidth is selected, an IF frequency of 300 kHz is used, and the image frequency is located at 600 kHz below the wanted frequency.

The bandwidth and center frequency of the IF filter are calibrated automatically after entering the PHY\_ON state if the BB\_CAL bit is set in the MODE\_CONTROL register (Address 0x11A). The filter calibration time takes 100 μs.

The IF bandwidth is programmed by setting the IFBW field in the RADIO\_CFG\_9 register (Address 0x115). The filter’s pass band is centered at an IF frequency of 200 kHz when bandwidths of 100 kHz to 200 kHz are used and centered at 300 kHz when an IF bandwidth of 300 kHz is used.

**IMAGE CHANNEL REJECTION**

The ADF7023 is capable of providing improved receiver image rejection performance by the use of a fully integrated image rejection calibration system under the control of the on-chip communications processor. To operate the calibration system, a firmware module is downloaded to the on-chip program RAM. The firmware download is supplied by Analog Devices and described in the Downloadable Firmware Modules section.

To achieve the typical uncalibrated image attenuation values given in the Specifications section, it is required to use recommended default values for IMAGE\_REJECT\_CAL\_PHASE (Address 0x118) and IMAGE\_REJECT\_CAL\_AMPLITUDE (Address 0x119).

To achieve the specified uncalibrated image attenuation at 433 MHz, set IMAGE\_REJECT\_CAL\_AMPLITUDE = 0x03 and IMAGE\_REJECT\_CAL\_PHASE = 0x08.

To achieve the specified uncalibrated image attenuation at 868 MHz/915 MHz, set IMAGE\_REJECT\_CAL\_AMPLITUDE = 0x07 and IMAGE\_REJECT\_CAL\_PHASE = 0x16.

**AUTOMATIC GAIN CONTROL (AGC)**

AGC is enabled by default, and keeps the receiver gain at the correct level by selecting the LNA, mixer, and filter gain settings based on the measured RSSI level. The LNA has three gain levels, the mixer has gain two levels, and the filter has three gain levels. In all, there are six AGC stages, which are defined in Table 32.

Table 32. AGC Gain Modes

Gain Mode	LNA Gain	Mixer Gain	Filter Gain
1	High	High	High
2	High	Low	High
3	Medium	Low	High
4	Low	Low	High
5	Low	Low	Medium
6	Low	Low	Low

The AGC remains at each gain stage for a time defined by the AGC\_CLK\_DIVIDE register (Address 0x32F). The default value of AGC\_CLK\_DIVIDE = 0x28 gives an AGC delay of 25 μs. When the RSSI is above AGC\_HIGH\_THRESHOLD (Address 0x35F), the gain is reduced. When the RSSI is below AGC\_LOW\_THRESHOLD (Address 0x35E), the gain is increased.

The AGC can be configured to remain active while in the PHY\_RX state or can be locked on preamble detection. The AGC can also be set to manual mode, in which case the host processor must set the LNA, filter, and mixer gains by writing to the AGC\_MODE register (Address 0x35D). The AGC operation is set by the AGC\_LOCK\_MODE setting in the RADIO\_CFG\_7 register (Address 0x113) and is described in Table 33.

The LNA, filter and mixer gains can be read back through the AGC\_GAIN\_STATUS register (Address 0x360).

**Table 33. AGC Operation**

AGC_LOCK_MODE Bits in RADIO_CFG_7 Register	Description
0	AGC is free running.
1	AGC is disabled. Gains must be set manually.
2	AGC is held at the current gain level.
3	AGC is locked on preamble detection.

**RSSI**

The RSSI is based on a successive compression, log-amp architecture following the analog channel filter. The analog RSSI level is digitized by an 8-bit SAR ADC for user readback and for use by the digital AGC controller.

The ADF7023 has a total of four RSSI measurement functions that support a wide range of applications. These functions can be used to implement carrier sense (CS) or clear channel assessment (CCA). In packet mode, the RSSI is automatically recorded in MCR memory and is available for user readback after receipt of a packet.

Table 36 details the four RSSI measurement methods.

**RSSI Method 1**

When a valid packet is received in packet mode, the RSSI level during postamble is automatically loaded to the RSSI\_READBACK register (Address 0x312) by the communications processor. The RSSI\_READBACK register contains a twos complement value and can be converted to input power in dBm using

$$RSSI(dBm) = RSSI\_READBACK - 107$$

To extend the linear range of RSSI measurement down to an input power of -110 dBm (see Figure 69), a cosine adjustment can be applied using the following formula:

$$RSSI(dBm) = \cos\left(\frac{8}{RSSI\_READBACK}\right) \times RSSI\_READBACK - 106$$

where COS(X) is the cosine of Angle X (radians).

**RSSI Method 2**

The CMD\_GET\_RSSI command can be used from the PHY\_ON state to read the RSSI. This RSSI measurement method uses additional low pass filtering, resulting in a more accurate RSSI reading. The RSSI result is loaded to the RSSI\_READBACK register (Address 0x312) by the communications processor. The RSSI\_READBACK register contains a twos complement value and can be converted to input power in dBm using the following formula:

$$RSSI(dBm) = RSSI\_READBACK - 107$$

**RSSI Method 3**

This method supports the measurement of RSSI by the host processor at any time while in the PHY\_RX state. The receiver input power can be calculated using the following procedure:

1. Set AGC to hold by setting the AGC\_MODE register (Address 0x35D) = 0x40 (only necessary if AGC has not been locked on the preamble or sync word).
2. Read back the AGC gain settings (AGC\_GAIN\_STATUS register, Address 0x360).
3. Read the ADC\_READBACK[7:0] value (Address 0x327 and Address 0x328; see the Analog-to-Digital Converter section).
4. Re-enable the AGC by setting the AGC\_MODE register (Address 0x35D) = 0x00 (only necessary if AGC has not already been locked on the preamble or sync word).
5. Calculate the RSSI in dBm as follows:

$$RSSI(dBm) = \left( ADC\_READBACK[7:0] \times \frac{1}{7} + Gain\_Correction \right) - 109$$

where Gain\_Correction is determined by the value of the AGC\_GAIN\_STATUS register (Address 0x360) as shown in Table 34.

**Table 34. Gain Mode Correction for 2FSK/GFSK/MSK/GMSK RSSI**

AGC_GAIN_STATUS (Address 0x360)	GAIN_CORRECTION
0x00	44
0x01	35
0x02	26
0x0A	17
0x12	10
0x16	0

To simplify the RSSI calculation, the following approximation can be used by the host processor:

$$\frac{1}{7} \approx \frac{1}{8} \left( 1 + \frac{1}{8} + \frac{1}{64} \right)$$

**RSSI Method 4**

This method is used to provide RSSI readback when using OOK demodulation in the PHY\_RX state. The receiver input power can be calculated using the following procedure:

1. Set AGC to hold by setting the AGC\_MODE register (Address 0x35D) = 0x40 (only necessary if AGC has not been locked on the preamble or sync word).
2. Read back the AGC gain settings (AGC\_GAIN\_STATUS register, Address 0x360).
3. Read the AGC\_ADC\_WORD[6:0] value (Address 0x361).
4. Re-enable the AGC by setting the AGC\_MODE register (Address 0x35D) = 0x00 (only necessary if AGC has not already been locked on the preamble or sync word).
5. Calculate the RSSI in dBm as follows:

$$RSSI(dBm) = (AGC\_ADC\_WORD[6:0] \times \frac{2}{7} + Gain\_Correction) - 110$$

where *Gain\_Correction* is determined by the value of the AGC\_GAIN\_STATUS register (Address 0x360) as shown in Table 35.

**Table 35. Gain Mode Correction for OOK RSSI**

AGC_GAIN_STATUS (Address 0x360)	GAIN_CORRECTION
0x00	47
0x01	37
0x02	28
0x0A	19
0x12	10
0x16	0

To simplify the RSSI calculation, the following approximation can be used by the host processor:

$$\frac{2}{7} \approx \frac{2}{8} \left( 1 + \frac{1}{8} + \frac{1}{64} \right)$$

**Table 36. Summary of RSSI Measurement Methods**

RSSI Method	RSSI Type	Modulation	Available in Packet Mode	Available in Sport Mode	Description
1	Automatic end of packet RSSI	2FSK/GFSK/MSK/GMSK	Yes	No	Automatic RSSI measurement during reception of the postamble in packet mode. The RSSI result is available in the RSSI_READBACK register (Address 0x312).
2	CMD_GET_RSSI command from PHY_ON	2FSK/GFSK/MSK/GMSK	Yes	Yes	Automatic RSSI measurement from PHY_ON using CMD_GET_RSSI. The RSSI result is available in the RSSI_READBACK register (Address 0x312).
3	RSSI via ADC and AGC readback, FSK	2FSK/GFSK/MSK/GMSK	Yes	Yes	RSSI measurement based on the ADC and AGC gain readbacks. The host processor calculates RSSI in dBm.
4	RSSI via ADC and AGC readback, OOK	OOK	Yes	Yes	RSSI measurement based on the ADC and AGC gain readbacks. The host processor calculates RSSI in dBm.

## 2FSK/GFSK/MSK/GMSK DEMODULATION

A correlator demodulator is used for 2FSK, GFSK, MSK, and GMSK demodulation. The quadrature outputs of the IF filter are first limited and then fed to a digital frequency correlator that performs filtering and frequency discrimination of the 2FSK/GFSK/MSK/GMSK spectrum. Data is recovered by comparing the output levels from two correlators. The performance of this frequency discriminator approximates that of a matched filter detector, which is known to provide optimum detection in the presence of additive white Gaussian noise (AWGN). This method of 2FSK/GFSK/MSK/GMSK demodulation provides approximately 3 dB to 4 dB better sensitivity than a linear frequency discriminator. The 2FSK/GFSK/MSK/GMSK demodulator architecture is shown in Figure 109. The ADF7023 is configured for 2FSK/GFSK/MSK/ GMSK demodulation by setting DEMOD\_SCHEME = 0 in the RADIO\_CFG\_9 register (Address 0x115).

To optimize receiver sensitivity, the correlator bandwidth and phase must be optimized for the specific deviation frequency, data rate, and maximum expected frequency error between the transmitter and receiver. The bandwidth and phase of the discriminator must be set using the DISCRIM\_BW bit in the RADIO\_CFG\_3 register (Address 0x10F) and the DISCRIM\_PHASE[1:0] bit in the RADIO\_CFG\_6 register (Address 0x112). The discriminator setup is performed in three steps.

### Step 1: Calculate the Discriminator Bandwidth Coefficient K

The Discriminator Bandwidth Coefficient K depends on the modulation index (MI), which is determined by

$$MI = \frac{2 \times FSK\_Dev}{Datarate}$$

where *FSK\_Dev* is the 2FSK/GFSK/MSK/GMSK frequency deviation in hertz (Hz), measured from the carrier to the +1 symbol frequency (positive frequency deviation) or to the -1 symbol frequency (negative frequency deviation), and *Datarate* is the data rate in bits per second (bps).

The value of K is then determined by

$$MI \geq 1, \text{ AFC off: } K = \text{Floor} \left[ \frac{IF\_Freq}{FSK\_Dev} \right]$$

$$MI < 1, \text{ AFC off: } K = \text{Floor} \left[ \frac{IF\_Freq}{\frac{Datarate}{2}} \right]$$

$$MI \geq 1, \text{ AFC on: } K = \text{Floor} \left[ \frac{IF\_Freq}{FSK\_Dev + Freq\_Error\_Max} \right]$$

$$MI < 1, \text{ AFC on: } K = \text{Floor} \left[ \frac{IF\_Freq}{\frac{Datarate}{2} + Freq\_Error\_Max} \right]$$

where:

*MI* is the modulation index.

*K* is the discriminator coefficient.

*Floor[]* is a function to round down to the nearest integer.

*IF\_Freq* is the IF frequency in hertz (200 kHz or 300 kHz).

*FSK\_Dev* is the 2FSK/GFSK/MSK/GMSK frequency deviation in hertz.

*Freq\_Error\_Max* is the maximum expected frequency error, in hertz, between Tx and Rx.

### Step 2: Calculate the DISCRIM\_BW Setting

The bandwidth setting of the discriminator is calculated based on the Discriminator Coefficient K and the IF frequency. The bandwidth is set using the DISCRIM\_BW setting (Address 0x10F), which is calculated according to

$$DISCRIM\_BW[7:0] = \text{Round} \left[ \frac{K \times 3.25 \text{ MHz}}{IF\_Freq} \right]$$

### Step 3: Calculate the DISCRIM\_PHASE Setting

The phase setting of the discriminator is calculated based on the Discriminator Coefficient K, as described in Table 37. The phase is set using the DISCRIM\_PHASE[1:0] value in the RADIO\_CFG\_6 register (Address 0x112).

**Table 37. Setting the DISCRIM\_PHASE[1:0] Value Based on K**

K	K/2	(K + 1)/2	DISCRIM_PHASE[1:0]
Even	Odd		0
Odd		Even	1
Even	Even		2
Odd		Odd	3

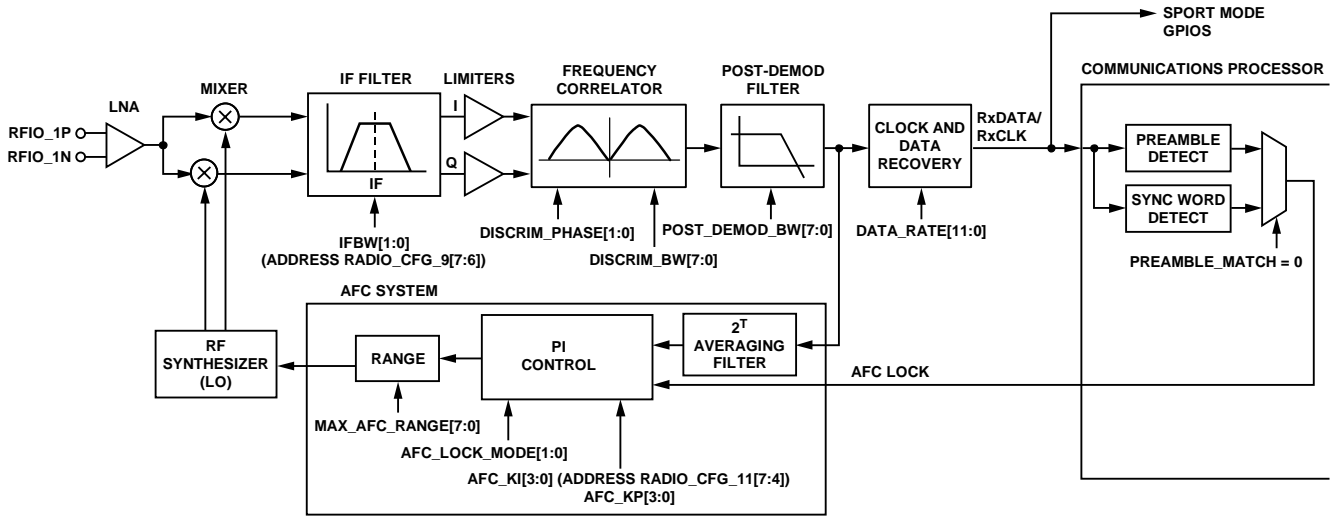

Figure 109. 2FSK/GFSK/MSK/GMSK Demodulation and AFC Architecture

**AFC**

The ADF7023 features an internal real-time automatic frequency control loop. In receive, the control loop automatically monitors the frequency error during the packet preamble sequence and adjusts the receiver synthesizer local oscillator using proportional integral (PI) control. The AFC frequency error measurement bandwidth is targeted specifically at the packet preamble sequence (dc free). AFC is supported during 2FSK/GFSK/MSK/GMSK demodulation.

AFC can be configured to lock on detection of the qualified preamble or on detection of the qualified sync word. To lock AFC on detection of the qualified preamble, set AFC\_LOCK\_MODE = 3 (Address 0x116) and ensure that preamble detection is enabled in the PREAMBLE\_MATCH register (Address 0x11B). AFC lock is released if the sync word is not detected immediately after the end of the preamble. In packet mode, if the qualified preamble is followed by a qualified sync word, the AFC lock is maintained for the duration of the packet. In sport mode, the AFC lock is released on transitioning back to the PHY\_ON state or when a CMD\_PHY\_RX is issued while in the PHY\_RX state.

To lock AFC on detection of the qualified sync word, set AFC\_LOCK\_MODE = 3 and ensure that preamble detection is disabled in the PREAMBLE\_MATCH register (Address 0x11B). If this mode is selected, consideration must be given to the selection of the sync word. The sync word should be dc free and have short run lengths yet low correlation with the preamble sequence. See the sync word description in the Packet Mode section for further details. After lock on detection of the qualified sync word, the AFC lock is maintained for the duration of the packet. In sport mode, the AFC lock is released on transitioning back to the PHY\_ON state or when CMD\_PHY\_RX is issued while in the PHY\_RX state.

AFC is enabled by setting AFC\_LOCK\_MODE in the RADIO\_CFG\_10 register (Address 0x116), as described in Table 38.

**Table 38. AFC Mode**

AFC_LOCK_MODE[1:0]	Mode
0	Free running: AFC is free running.
1	Disabled: AFC is disabled.
2	Hold: AFC is paused.
3	Lock: AFC locks after the preamble or sync word.

The bandwidth of the AFC loop can be controlled by the AFC\_KI and AFC\_KP parameters in the RADIO\_CFG\_11 register (Address 0x117).

The maximum AFC pull-in range is automatically set based on the programmed IF filter bandwidth (IFBW in the RADIO\_CFG\_9 register (Address 0x115)).

**Table 39. Maximum AFC Pull-In Range**

IF Bandwidth	Max AFC Pull-In Range
100 kHz	±50 kHz
150 kHz	±75 kHz
200 kHz	±100 kHz
300 kHz	±150 kHz

**AFC and Preamble Length**

The AFC requires a certain number of the received preamble bits to correct the frequency error between the transmitter and the receiver. The number of preamble bits required depends on the data rate and whether the AFC is locked on detection of the qualified preamble or locked on detection of the qualified sync word. This is discussed in more detail in the Recommended Receiver Settings for 2FSK/GFSK/MSK/GMSK section.

### AFC Readback

The frequency error between the received carrier and the receiver local oscillator can be measured when AFC is enabled. The error value can be read from the FREQUENCY\_ERROR\_READBACK register (Address 0x372), where each LSB equates to 1 kHz. The value is a twos complement number. The FREQUENCY\_ERROR\_READBACK value is valid in the PHY\_RX state after the AFC has been locked. The value is retained in the FREQUENCY\_ERROR\_READBACK register after recovering a packet and transitioning back to the PHY\_ON state.

### Post-Demodulator Filter

A second-order, digital low-pass filter removes excess noise from the demodulated bit stream at the output of the discriminator. The bandwidth of this post-demodulator filter is programmable and must be optimized for the user's data rate and received modulation type. If the bandwidth is set too narrow, performance degrades due to intersymbol interference (ISI). If the bandwidth is set too wide, excess noise degrades the performance of the receiver. For optimum performance, the post-demodulator filter bandwidth should be set close to 0.75 times the data rate (when using FSK/GFSK/MSK/GMSK modulation). The actual bandwidth of the post-demodulator filter is given by

$$\text{Post-Demodulator Filter Bandwidth (kHz)} = \text{POST\_DEMOD\_BW} \times 2$$

where *POST\_DEMOD\_BW* is set in the RADIO\_CFG\_4 register (Address 0x110).

### CLOCK RECOVERY

An oversampled digital clock and data recovery (CDR) PLL is used to resynchronize the received bit stream to a local clock in all modulation modes. The maximum symbol rate tolerance of the CDR PLL is determined by the number of bit transitions in the transmitted bit stream. For example, during reception of a 010101 preamble, the CDR achieves a maximum data rate tolerance of  $\pm 3.0\%$ . However, this tolerance is reduced during recovery of the remainder of the packet where symbol transitions may not be guaranteed to occur at regular intervals during the payload data. To maximize data rate tolerance of the receiver's CDR, 8b/10b encoding or Manchester encoding should be enabled, which guarantees a maximum number of contiguous bits in the transmitted bit stream. Data whitening can also be enabled on the ADF7023 to break up long sequences of contiguous data bit patterns.

Using 2FSK/GFSK/MSK/GMSK modulation, it is also possible to tolerate uncoded payload data fields and payload data fields with long run length coding constraints if the data rate tolerance and packet length are both constrained. More details of CDR operation using uncoded packet formats are discussed in the AN-915 Application Note.

The ADF7023's CDR PLL is optimized for fast acquisition of the recovered symbols during preamble and typically achieves bit synchronization within five symbol transitions of preamble.

### OOK DEMODULATION

The ADF7023 can be configured for OOK demodulation by setting DEMOD\_SCHEME = 2 in the RADIO\_CFG\_9 register (Address 0x115). Manchester encoding should be used with OOK modulation to ensure optimum performance. OOK demodulation is performed using the receiver's RSSI signal in conjunction with a fully automatic threshold detection circuit, which extracts the optimum OOK threshold during preamble and maintains robust packet error performance over the full input power range. The bandwidth of the threshold detection circuit is set by the AFC\_KI and AFC\_KP parameters in the RADIO\_CFG\_11 register (Address 0x117). The AGC loop bandwidth can be independently optimized for acquisition and tracking modes during OOK reception by setting OOK\_AGC\_CLK\_ACQ and OOK\_AGC\_CLK\_TRK (Address 0x35B), respectively. This demodulation scheme delivers high receiver saturation performance in OOK mode. The receiver also supports OOK modulation depths of up to 20 dB.

For optimum performance, the AGC and threshold detection circuit should be set to lock after preamble detection by setting AGC\_LOCK\_MODE = 3 in the RADIO\_CFG\_7 register (Address 0x113) and AFC\_LOCK\_MODE = 3 in the RADIO\_CFG\_10 register (Address 0x116).

The recommended post-demodulator filter bandwidth is 1.6 times the chip rate when using OOK demodulation. This can be configured via the POST\_DEMOD\_BW setting in the RADIO\_CFG\_4 register (Address 0x110).



## RECOMMENDED RECEIVER SETTINGS FOR 2FSK/GFSK/MSK/GMSK

To optimize the ADF7023 receiver performance and to ensure the lowest possible packet error rate, it is recommended to use the following configurations:

- Set the recommended AGC low and high thresholds and the AGC clock divide.
- Set the recommended AFC Ki and Kp parameters.
- Use a preamble length  $\geq$  the minimum recommended preamble length.
- When the AGC is configured to lock on the sync word at data rates greater than 200 kbps, it is recommended to set the sync word error tolerance to one bit.

The recommended settings for AGC, AFC, preamble length, and sync word are summarized in Table 41.

### Recommended AGC Settings

To optimize the receiver for robust packet error rate performance, when using minimum preamble length over the full input power range, it is recommended to overwrite the default AGC settings in the MCR memory. The recommended settings are as follows:

- AGC\_HIGH\_THRESHOLD (Address 0x35F) = 0x78
- AGC\_LOW\_THRESHOLD (Address 0x35E) = 0x46

AGC\_CLOCK\_DIVIDE (Address 0x32F) = 0x0F or 0x19 (depends on the data rate; see Table 41)

MCR memory is not retained in PHY\_SLEEP; therefore, to allow the use of these optimized AGC settings in low power mode applications, a static register fix can be used. An example static register fix to write to the AGC settings in MCR memory is shown in Table 40.

Table 40. Example Static Register Fix for AGC Settings

BBRAM Register	Data	Description
0x128 (STATIC_REG_FIX)	0x2B	Pointer to BBRAM Address 0x12B
0x12B	0x5E	MCR Address 0x35E
0x12C	0x46	Data to write to MCR Address 0x35E (sets AGC low threshold)
0x12D	0x5F	MCR Address 0x35F
0x12E	0x78	Data to write to MCR Address 0x35F (sets AGC high threshold)
0x12F	0x2F	MCR Address 0x32F
0x130	0x0F	Data to write to MCR Address 0x32F (sets AGC clock divide)
0x131	0x00	Ends static MCR register fixes

### Recommended AFC Settings

The bandwidth of the AFC loop is controlled by the AFC\_KI and AFC\_KP parameters in the RADIO\_CFG\_11 register (Address 0x117). To ensure optimum AFC accuracy while minimizing the AFC settling time (and thus the required preamble length), the AFC\_KI and AFC\_KP parameters should be set as outlined in Table 41.

### Recommended Preamble Length

When AFC is locked on preamble detection, the minimum preamble length is between 40 and 60 bits depending on the data rate. When AFC is set to lock on sync word detection, the minimum preamble length is between 14 and 32 bits, depending on the data rate. When AFC and preamble detection are disabled, the minimum preamble length is dependent on the AGC settling time and the CDR acquisition time and is between 8 and 24 bits, depending on the data rate. The required preamble length for various data rates and receiver configurations is summarized in Table 41.

### Recommended Sync Word Tolerance

At data rates greater than 200 kbps and when the AGC is configured to lock on the sync word, it is recommended to set the sync word error tolerance to one bit (SYNC\_ERROR\_TOL = 1). This prevents an AGC gain change during sync word reception causing a packet loss by allowing one bit error in the received sync word.

Table 41. Summary of Recommended AGC, AFC, Preamble Length, and Sync Word Error Tolerance for 2FSK/GFSK/MSK/GMSK

Data Rate (kbps)	Freq Deviation (kHz)	IF BW (kHz)	Setup <sup>1</sup>	AGC <sup>2</sup>			AFC <sup>3</sup>			Minimum Preamble Length (Bits) <sup>4</sup>	Sync Word Error Tolerance (Bits) <sup>5</sup>
				High Threshold	Low Threshold	Clock Divide	On/Off	Ki	Kp		
300	75	300	1	0x78	0x46	0x0F	On	7	3	64	0
			2	0x78	0x46	0x19	On	8	3	32	1
			3	0x78	0x46	0x19	Off			24	1
200	50	200	1	0x78	0x46	0x19	On	7	3	58	0
150	37.5	150	1	0x78	0x46	0x19	On	7	3	54	0
100	25	100	1	0x78	0x46	0x19	On	7	3	52	0
50	12.5	100	1	0x78	0x46	0x19	On	7	3	50	0
38.4	20	100	1	0x78	0x46	0x19	On	7	3	44	0
			2	0x78	0x46	0x19	On	7	3	14	0
			3	0x78	0x46	0x19	Off			8	0
9.6	10	100	1	0x78	0x46	0x19	On	7	3	46	0
			3	0x78	0x46	0x19	Off			8	0
1	10	100	1	0x78	0x46	0x19	On	7	3	40	0
			3	0x78	0x46	0x19	Off			8	0

<sup>1</sup> Setup 1: AFC and AGC are configured to lock on preamble detection by setting AFC\_LOCK\_MODE = 3 and AGC\_LOCK\_MODE = 3.

Setup 2: AFC and AGC are configured to lock on sync word detection by setting AFC\_LOCK\_MODE = 3, AGC\_LOCK\_MODE = 3, and PREAMBLE\_MATCH = 0.

Setup 3: AFC is disabled and AGC is configured to lock on sync word detection by setting AFC\_LOCK\_MODE = 1, AGC\_LOCK\_MODE = 3, and PREAMBLE\_MATCH = 0.

<sup>2</sup> The AGC high threshold is configured by writing to the AGC\_HIGH\_THRESHOLD register (Address 0x35F). The AGC low threshold is configured by writing to the AGC\_LOW\_THRESHOLD register (Address 0x35E). The AGC clock divide is configured by writing to the AGC\_CLOCK\_DIVIDE register (Address 0x32F).

<sup>3</sup> The AFC is enabled or disabled by writing to the AFC\_LOCK\_MODE setting in register RADIO\_CFG\_10 (Address 0x116). The AFC Ki and Kp parameters are configured by writing to the AFC\_KP and AFC\_KI settings in the RADIO\_CFG\_11 register (Address 0x117).

<sup>4</sup> The transmit preamble length (in bytes) is set by writing to the PREAMBLE\_LEN register (Address 0x11D).

<sup>5</sup> The sync word error tolerance (in bits) is set by writing to the SYNC\_ERROR\_TOL setting in the SYNC\_CONTROL register (Address 0x120).

## RECOMMENDED RECEIVER SETTINGS FOR OOK

To ensure robust OOK reception, the AGC threshold detection, preamble length, and post-demodulator filter bandwidth are recommended to be set as detailed in Table 42.

Table 42. Summary of Recommended Settings for AGC, AFC, and Preamble Length in OOK Demodulation

Data Rate (kbps)	Chip Rate (kcps)	IF BW (kHz)	AGC <sup>1</sup>					Threshold Detection <sup>2</sup>			Minimum Preamble Length (Bits)	Post-Demodulator Bandwidth
			High Threshold	Low Threshold	AGC_LOCK_MODE	OOK_AGC_CLK_ACQ	OOK_AGC_CLK_TRK	AFC_KI	AFC_KP	AFC_LOCK_MODE		
2.4 to 19.2	4.8 to 38.4	100	0x69	0x2D	3	1	2	6	3	3	64	1.6 × chip rate

<sup>1</sup> The recommended values for the AGC high threshold (AGC\_HIGH\_THRESHOLD), OOK\_AGC\_CLK\_ACQ, and OOK\_AGC\_CLK\_TRK are the same as the default values and, therefore, do not need to be set by the host processor. The AGC low threshold is configured by writing to the AGC\_LOW\_THRESHOLD register (Address 0x35E). The AGC lock on preamble detection is configured by setting AGC\_LOCK\_MODE = 3 (in register RADIO\_CFG\_7, Address 0x113).

<sup>2</sup> The AFC\_KI and AFC\_KP parameters control the bandwidth of the threshold detection loop in OOK demodulation. They are configured by writing to the RADIO\_CFG\_11 register (Address 0x117). Setting AFC\_LOCK\_MODE = 3 configures the OOK threshold detection to lock on preamble detection.

## PERIPHERAL FEATURES

### ANALOG-TO-DIGITAL CONVERTER

The ADF7023 supports an integrated SAR ADC for digitization of analog signals that include the analog temperature sensor, the analog RSSI level, and an external analog input signal (Pin 30). The conversion time is typically 1  $\mu$ s. The result of the conversion can be read from the ADC\_READBACK\_HIGH register (Address 0x327), and the ADC\_READBACK\_LOW register (Address 0x328). The ADC readback is an 8-bit value.

The signal source for the ADC input is selected via the ADC\_CONFIG\_LOW register (Address 0x359). In the PHY\_RX state, the source is automatically set to the analog RSSI. The ADC is automatically enabled in PHY\_RX. In other radio states, the host processor must enable the ADC by setting POWERDOWN\_RX (Address 0x324) = 0x10.

To perform an ADC readback, the following procedure should be completed:

1. Read ADC\_READBACK\_HIGH. This initializes an ADC readback.
2. Read ADC\_READBACK\_LOW. This returns ADC\_READBACK[1:0] of the ADC sample.
3. Read ADC\_READBACK\_HIGH. This returns ADC\_READBACK[7:2] of the ADC sample.

### TEMPERATURE SENSOR

The integrated temperature sensor has an operating range between  $-40^{\circ}\text{C}$  and  $+85^{\circ}\text{C}$ . To enable readback of the temperature sensor in PHY\_OFF, PHY\_ON, or PHY\_TX, the following registers must be set:

1. Set POWERDOWN\_RX (Address 0x324) = 0x10 = 0x10. This enables the ADC.
2. Set POWERDOWN\_AUX (Address 0x325) = 0x02. This enables the temperature sensor.
3. Set ADC\_CONFIG\_LOW (Address 0x359) = 0x08. This sets the ADC input to the temperature sensor.

The temperature is determined from the ADC readback value using the following formula:

$$\text{Temperature } (^{\circ}\text{C}) = 0.9474 \times (\text{ADC\_READBACK}[7:0]) - \text{Calibration Value}[7:0] + T_{\text{CALIBRATION}}$$

The Calibration Value[7:0] is determined via an ADC readback at a single known temperature,  $T_{\text{CALIBRATION}}$ . When this correction is applied, the temperature sensor is accurate to  $+7^{\circ}\text{C}$  to  $-4^{\circ}\text{C}$  over the full operating temperature range.

### TEST DAC

The test DAC allows the output of the post-demodulator filter to be viewed externally. It takes the 16-bit filter output and converts it to a high frequency, single-bit output using a second order  $\Sigma$ - $\Delta$  converter. The output can be viewed on the GP0 pin. This signal, when filtered appropriately, can be used to

- Monitor the signal at the post-demodulator filter output
- Measure the demodulator output SNR
- Construct an eye diagram of the received bit stream to measure the received signal quality
- Implement analog FM demodulation

To enable the test DAC, the GPIO\_CONFIGURE setting (Address 0x3FA) should be set to 0xC9. The TEST\_DAC\_GAIN setting (Address 0x3FD) should be set to 0x00. The test DAC signal at the GP0 pin can be filtered with a three-stage, low-pass RC filter to reconstruct the demodulated signal. For more information, see the AN-852 Application Note.

### TRANSMIT TEST MODES

There are two transmit test modes that are enabled by setting the VAR\_TX\_MODE parameter (Address 0x00D in packet RAM memory), as described in Table 43. VAR\_TX\_MODE should be set before entering the PHY\_TX state.

**Table 43. Transmit Test Modes**

VAR_TX_MODE	Mode
0	Default; no transmit test mode
1	Transmit random data continuously
2	Transmit the preamble continuously
3	Transmit the carrier continuously
4 to 255	Reserved

### SILICON REVISION READBACK

The product code and silicon revision code can be read from the packet RAM memory as described in Table 44. The values of the product code and silicon revision code are valid only on power-up or wake-up from the PHY\_SLEEP state because the communications processor overwrites these values on transitioning from the PHY\_ON state.

**Table 44. Product Code and Silicon Revision Code**

Packet Ram Location	Description
0x001	Product code, most significant byte = 0x70
0x002	Product code, least significant byte = 0x23
0x003	Silicon revision code, most significant byte
0x004	Silicon revision code least significant byte

# APPLICATIONS INFORMATION

## APPLICATION CIRCUIT

A typical application circuit for the ADF7023 is shown in Figure 110. All external components required for operation of the device, excluding supply decoupling capacitors, are shown.

This example circuit uses a combined single-ended PA and LNA match. Further details on matching topologies and different host processor interfaces are given in the following sections.



Figure 110. Typical ADF7023 Application Circuit Diagram

08291-039

**HOST PROCESSOR INTERFACE**

The interface, when using packet mode, between the ADF7023 and the host processor is shown in Figure 111. In packet mode, all communication between the host processor and the ADF7023 occurs on the SPI interface and the IRQ\_GP3 pin. The interface between the ADF7023 and the host processor in sport mode is shown in Figure 112. In sport mode, the transmit and receive data interface consists of the GP0, GP1, and GP2 pins and a separate interrupt is available on GP4, while the SPI interface is used for memory access and issuing of commands.



Figure 111. Processor Interface in Packet Mode



Figure 112. Processor Interface in Sport Mode

**PA/LNA MATCHING**

The AD7023 has a differential LNA and both a single-ended PA and differential PA. This flexibility allows numerous possibilities in interfacing the ADF7023 to the antenna.

**Combined Single-Ended PA and LNA Match**

The combined single-ended PA and LNA match allows the transmit and receive paths to be combined without the use of an external transmit/receive switch. The matching network design is shown in Figure 113. The differential LNA match is a five-element discrete balun giving a single-ended input. The single-ended PA output is a three-element match consisting of the choke inductor to the CREGRF2 regulated supply and an inductor and capacitor series.

The LNA and PA paths are combined, and a T-stage harmonic filter provides attenuation of the transmit harmonics. In a combined match, the off impedances of the PA and LNA must be considered. This can lead to a small loss in transmit power and degradation in receiver sensitivity in comparison with a separate single-ended PA and LNA match. However, with optimum matching, the typical loss in transmit power is <1dB, and the degradation in sensitivity is < 1 dB when compared with a separate PA and LNA matching topology.

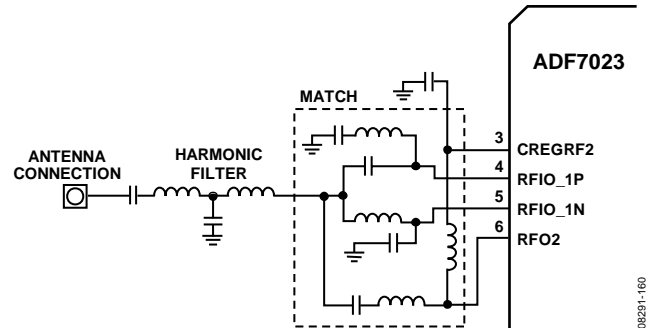

Figure 113. Combined Single-Ended PA and LNA Match

**Separate Single-Ended PA/LNA Match**

The separate single-ended PA and LNA matching configuration is illustrated in Figure 114. The network is the same as the combined matching network shown in Figure 113 except that the transmit and receive paths are separate. An external transmit/receive antenna switch can be used to combine the transmit and receive paths to allow connection to an antenna. In designing this matching network, it is not necessary to consider the off impedances of the PA and LNA, and, thus, achieving an optimum match is less complex than with the combined single-ended PA and LNA match.

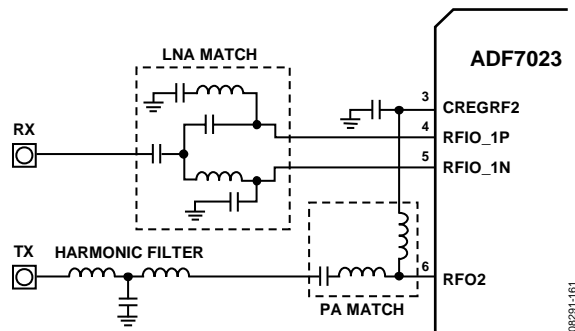

Figure 114. Separate Single-Ended PA and LNA Match

**Combined Differential PA/LNA Match**

In this matching topology, the single-ended PA is not used. The differential PA and LNA match comprises a five-element discrete balun giving a single-ended input/output as illustrated in Figure 115. The harmonic filter is used to minimize the RF harmonics from the differential PA.

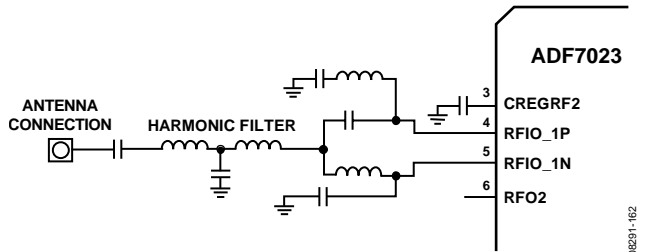

Figure 115. Combined Differential PA and LNA Match

**Transmit Antenna Diversity**

Transmit antenna diversity is possible using the differential PA and single-ended PA. The required matching network is shown in Figure 116.



Figure 116. Matching Topology for Transmit Antenna Diversity

**Support for External PA and LNA Control**

The ADF7023 provides independent control signals for an external PA or LNA. If the EXT\_PA\_EN bit is set to 1 in the MODE\_CONTROL register (Address 0x11A), the external PA control signal is logic high while the ADF7023 is in the PHY\_TX state and logic low while in any other state. If the EXT\_LNA\_EN bit is set to 1 in the MODE\_CONTROL register (Address 0x11A), the external LNA control signal is logic high while the ADF7023 is in the PHY\_RX state and logic low while in any other state.

The external PA and LNA control signals can be configured using the EXT\_PA\_LNA\_ATB\_CONFIG setting (Address 0x139, Bit[7]) as described in Table 45.

**Table 45. Configuration of the External PA and LNA Control Signals**

EXT_PA_LNA_ATB_CONFIG	Configuration
1	ADCIN_ATB3 and ATB4 used for control of external PA and external LNA, respectively (1.8 V logic outputs).
0	XOSC32KP_GP5_ATB1 and XOSC32KN_ATB2 used for control of external PA and external LNA, respectively (V <sub>DD</sub> logic outputs).

## COMMAND REFERENCE

Table 46. Radio Controller Commands

Command	Code	Description
CMD_SYNC	0xA2	This is an optional command. It is not necessary to use it during device initialization
CMD_PHY_OFF	0xB0	Performs a transition of the device into the PHY_OFF state.
CMD_PHY_ON	0xB1	Performs a transition of the device into the PHY_ON state.
CMD_PHY_RX	0xB2	Performs a transition of the device into the PHY_RX state.
CMD_PHY_TX	0xB5	Performs a transition of the device into the PHY_TX state.
CMD_PHY_SLEEP	0xBA	Performs a transition of the device into the PHY_SLEEP state.
CMD_CONFIG_DEV	0xBB	Configures the radio parameters based on the BBRAM values.
CMD_GET_RSSI	0xBC	Performs an RSSI measurement.
CMD_BB_CAL	0xBE	Performs a calibration of the IF filter.
CMD_HW_RESET	0xC8	Performs a full hardware reset. The device enters the PHY_SLEEP state.
CMD_RAM_LOAD_INIT	0xBF	Prepares the program RAM for a firmware module download.
CMD_RAM_LOAD_DONE	0xC7	Performs a reset of the communications processor after download of a firmware module to program RAM.
CMD_IR_CAL <sup>1</sup>	0xBD	Initiates an image rejection calibration routine.
CMD_AES_ENCRYPT <sup>2</sup>	0xD0	Performs an AES encryption on the transmit payload data stored in packet RAM.
CMD_AES_DECRYPT <sup>2</sup>	0xD2	Performs an AES decryption on the received payload data stored in packet RAM.
CMD_AES_DECRYPT_INIT	0xD1	Initializes the internal variables required for AES decryption.
CMD_RS_ENCODE_INIT <sup>3</sup>	0xD1	Initializes the internal variables required for the Reed Solomon encoding.
CMD_RS_ENCODE <sup>3</sup>	0xD0	Calculates and appends the Reed Solomon check bytes to the transmit payload data stored in packet RAM.
CMD_RS_DECODE <sup>3</sup>	0xD2	Performs a Reed Solomon error correction on the received payload data stored in packet RAM.

<sup>1</sup> The image rejection calibration firmware module must be loaded to program RAM for this command to be functional.

<sup>2</sup> The AES firmware module must be loaded to program RAM for this command to be functional.

<sup>3</sup> The Reed Solomon Coding firmware module must be loaded to program RAM for this command to be functional.

Table 47. SPI Commands

Command	Code	Description
SPI_MEM_WR	00011xxx = 0x18 (packet RAM) 0x19 (BBRAM) 0x1B (MCR) 0x1E (program RAM)	Writes data to BBRAM, MCR, or packet RAM memory sequentially. An 11-bit address is used to identify memory locations. The most significant three bits of the address are incorporated into the command (xxx). This command is followed by the remaining eight bits of the address, which are subsequently followed by the data bytes to be written.
SPI_MEM_RD	00111xxx = 0x38 (packet RAM) 0x39 (BBRAM) 0x3B (MCR)	Reads data from BBRAM, MCR, or packet RAM memory sequentially. An 11-bit address is used to identify memory locations. The most significant three bits of the address are incorporated into the command (xxx). This command is followed by the remaining eight bits of the address, which are subsequently followed by the appropriate number of SPI_NOP commands.
SPI_MEMR_WR	00001xxx = 0x08 (packet RAM) 0x09 (BBRAM) 0x0B (MCR)	Writes data to BBRAM, MCR, or packet RAM memory nonsequentially.
SPI_MEMR_RD	00101xxx = 0x28 (packet RAM) 0x29 (BBRAM) 0x2B (MCR)	Reads data from BBRAM, MCR, or packet RAM memory nonsequentially.
SPI_NOP	0xFF	No operation. Use for dummy writes when polling the status word; used also as dummy data when performing a memory read.

## REGISTER MAPS

Table 48. Battery Backup Memory (BBRAM)

Address (Hex)	Register	Retained in PHY_SLEEP	R/W	Group
0x100	INTERRUPT_MASK_0	Yes	R/W	MAC
0x101	INTERRUPT_MASK_1	Yes	R/W	MAC
0x102	NUMBER_OF_WAKEUPS_0	Yes	R/W	MAC
0x103	NUMBER_OF_WAKEUPS_1	Yes	R/W	MAC
0x104	NUMBER_OF_WAKEUPS_IRQ_THRESHOLD_0	Yes	R/W	MAC
0x105	NUMBER_OF_WAKEUPS_IRQ_THRESHOLD_1	Yes	R/W	MAC
0x106	RX_DWELL_TIME	Yes	R/W	MAC
0x107	PARMTIME_DIVIDER	Yes	R/W	MAC
0x108	SWM_RSSI_THRESH	Yes	R/W	PHY
0x109	CHANNEL_FREQ_0	Yes	R/W	PHY
0x10A	CHANNEL_FREQ_1	Yes	R/W	PHY
0x10B	CHANNEL_FREQ_2	Yes	R/W	PHY
0x10C	RADIO_CFG_0	Yes	R/W	PHY
0x10D	RADIO_CFG_1	Yes	R/W	PHY
0x10E	RADIO_CFG_2	Yes	R/W	PHY
0x10F	RADIO_CFG_3	Yes	R/W	PHY
0x110	RADIO_CFG_4	Yes	R/W	PHY
0x111	RADIO_CFG_5	Yes	R/W	PHY
0x112	RADIO_CFG_6	Yes	R/W	PHY
0x113	RADIO_CFG_7	Yes	R/W	PHY
0x114	RADIO_CFG_8	Yes	R/W	PHY
0x115	RADIO_CFG_9	Yes	R/W	PHY
0x116	RADIO_CFG_10	Yes	R/W	PHY
0x117	RADIO_CFG_11	Yes	R/W	PHY
0x118	IMAGE_REJECT_CAL_PHASE	Yes	R/W	PHY
0x119	IMAGE_REJECT_CAL_AMPLITUDE	Yes	R/W	PHY
0x11A	MODE_CONTROL	Yes	R/W	PHY
0x11B	PREAMBLE_MATCH	Yes	R/W	Packet
0x11C	SYMBOL_MODE	Yes	R/W	Packet
0x11D	PREAMBLE_LEN	Yes	R/W	Packet
0x11E	CRC_POLY_0	Yes	R/W	Packet
0x11F	CRC_POLY_1	Yes	R/W	Packet
0x120	SYNC_CONTROL	Yes	R/W	Packet
0x121	SYNC_BYTE_0	Yes	R/W	Packet
0x122	SYNC_BYTE_1	Yes	R/W	Packet
0x123	SYNC_BYTE_2	Yes	R/W	Packet
0x124	TX_BASE_ADR	Yes	R/W	Packet
0x125	RX_BASE_ADR	Yes	R/W	Packet
0x126	PACKET_LENGTH_CONTROL	Yes	R/W	Packet
0x127	PACKET_LENGTH_MAX	Yes	R/W	Packet
0x128	STATIC_REG_FIX	Yes	R/W	PHY
0x129	ADDRESS_MATCH_OFFSET	Yes	R/W	Packet
0x12A to 0x137	Address filtering	Yes	R/W	Packet
0x138	RSSI_WAIT_TIME	Yes	R/W	PHY
0x139	TESTMODES	Yes	R/W	MAC
0x13A	TRANSITION_CLOCK_DIV	Yes	R/W	PHY
0x13B to 0x13D	Reserved; set to 0x00	Not applicable	R/W	Not applicable
0x13E	RX_SYNTH_LOCK_TIME	Yes	R/W	PHY
0x13F	TX_SYNTH_LOCK_TIME	Yes	R/W	PHY



Table 49. Modem Configuration Memory (MCR)

Address (Hex)	Register	Retained in PHY_SLEEP	R/W
0x307	PA_LEVEL_MCR	No	R/W
0x30C	WUC_CONFIG_HIGH	No	W
0x30D	WUC_CONFIG_LOW	No	W
0x30E	WUC_VALUE_HIGH	No	W
0x30F	WUC_VALUE_LOW	No	W
0x310	WUC_FLAG_RESET	No	R/W
0x311	WUC_STATUS	No	R
0x312	RSSI_READBACK	No	R
0x315	MAX_AFC_RANGE	No	R/W
0x319	IMAGE_REJECT_CAL_CONFIG	No	R/W
0x322	CHIP_SHUTDOWN	No	R/W
0x324	POWERDOWN_RX	No	R/W
0x325	POWERDOWN_AUX	No	R/W
0x327	ADC_READBACK_HIGH	No	R
0x328	ADC_READBACK_LOW	No	R
0x32D	BATTERY_MONITOR_THRESHOLD_VOLTAGE	No	R/W
0x32E	EXT_UC_CLK_DIVIDE	No	R/W
0x32F	AGC_CLK_DIVIDE	No	R/W
0x336	INTERRUPT_SOURCE_0	No	R/W
0x337	INTERRUPT_SOURCE_1	No	R/W
0x338	CALIBRATION_CONTROL	No	R/W
0x339	CALIBRATION_STATUS	No	R
0x345	RXBB_CAL_CALWRD_READBACK	No	R
0x346	RXBB_CAL_CALWRD_OVERWRITE	No	RW
0x34F	RCOSC_CAL_READBACK_HIGH	No	R
0x350	RCOSC_CAL_READBACK_LOW	No	R
0x359	ADC_CONFIG_LOW	No	R/W
0x35A	ADC_CONFIG_HIGH	No	R/W
0x35B	AGC_OOK_CONTROL	No	R/W
0x35C	AGC_CONFIG	No	R/W
0x35D	AGC_MODE	No	R/W
0x35E	AGC_LOW_THRESHOLD	No	R/W
0x35F	AGC_HIGH_THRESHOLD	No	R/W
0x360	AGC_GAIN_STATUS	No	R
0x361	AGC_ADC_WORD	No	R
0x372	FREQUENCY_ERROR_READBACK	No	R
0x3CB	VCO_BAND_OVRW_VAL	No	R/W
0x3CC	VCO_AMPL_OVRW_VAL	No	R/W
0x3CD	VCO_OVRW_EN	No	R/W
0x3D0	VCO_CAL_CFG	No	R/W
0x3D2	OSC_CONFIG	No	R/W
0x3DA	VCO_BAND_READBACK	No	R
0x3DB	VCO_AMPL_READBACK	No	R
0x3F8	ANALOG_TEST_BUS	No	R/W
0x3F9	RSSI_TSTMUX_SEL	No	R/W
0x3FA	GPIO_CONFIGURE	No	R/W
0x3FD	TEST_DAC_GAIN	No	R/W

Table 50. Packet RAM Memory

Address	Register	R/W
0x000	VAR_COMMAND	R/W
0x001 <sup>1</sup>	Product code, most significant byte = 0x70	R
0x002 <sup>1</sup>	Product code, least significant byte = 0x23	R
0x003 <sup>1</sup>	Silicon revision code, most significant byte	R
0x004 <sup>1</sup>	Silicon revision code, least significant byte	R
0x005 to 0x00B	Reserved	R
0x00D	VAR_TX_MODE	R/W
0x00E to 0x00F	Reserved	R

<sup>1</sup> Only valid on power-up or wake-up from the PHY\_SLEEP state because the communications processor overwrites these values on exit from the PHY\_ON state.

## BGRAM REGISTER DESCRIPTION

Table 51. 0x100: INTERRUPT\_MASK\_0

Bit	Name	R/W	Description
[7]	INTERRUPT_NUM_WAKEUPS	R/W	Interrupt when the number of WUC wake-ups (NUMBER_OF_WAKEUPS[15:0]) has reached the threshold (NUMBER_OF_WAKEUPS_IRQ_THRESHOLD[15:0]) 1: interrupt enabled; 0: interrupt disabled
[6]	INTERRUPT_SWM_RSSI_DET	R/W	Interrupt when the measured RSSI during smart wake mode has exceeded the RSSI threshold value (SWM_RSSI_THRESH, Address 0x108) 1: interrupt enabled; 0: interrupt disabled
[5]	INTERRUPT_AES_DONE	R/W	Interrupt when an AES encryption or decryption command is complete; available only when the AES firmware module has been loaded to the ADF7023 program RAM 1: interrupt enabled; 0: interrupt disabled
[4]	INTERRUPT_TX_EOF	R/W	Interrupt when a packet has finished transmitting 1: interrupt enabled; 0: interrupt disabled
[3]	INTERRUPT_ADDRESS_MATCH	R/W	Interrupt when a received packet has a valid address match 1: interrupt enabled; 0: interrupt disabled
[2]	INTERRUPT_CRC_CORRECT	R/W	Interrupt when a received packet has the correct CRC 1: interrupt enabled; 0: interrupt disabled
[1]	INTERRUPT_SYNC_DETECT	R/W	Interrupt when a qualified sync word has been detected in the received packet 1: interrupt enabled; 0: interrupt disabled
[0]	INTERRUPT_PREMABLE_DETECT	R/W	Interrupt when a qualified preamble has been detected in the received packet 1: interrupt enabled; 0: interrupt disabled

Table 52. 0x101: INTERRUPT\_MASK\_1

Bit	Name	R/W	Description
[7]	BATTERY_ALARM	R/W	Interrupt when the battery voltage has dropped below the threshold value (BATTERY_MONITOR_THRESHOLD_VOLTAGE, Address 0x32D) 1: interrupt enabled; 0: interrupt disabled
[6]	CMD_READY	R/W	Interrupt when the communications processor is ready to load a new command; mirrors the CMD_READY bit of the status word 1: interrupt enabled; 0: interrupt disabled
[5]	Reserved	R/W	
[4]	WUC_TIMEOUT	R/W	Interrupt when the WUC has timed out 1: interrupt enabled; 0: interrupt disabled
[3]	Reserved	R/W	
[2]	Reserved	R/W	
[1]	SPI_READY	R/W	Interrupt when the SPI is ready for access 1: interrupt enabled; 0: interrupt disabled
[0]	CMD_FINISHED	R/W	Interrupt when the communications processor has finished performing a command 1: interrupt enabled; 0: interrupt disabled

Table 53. 0x102: NUMBER\_OF\_WAKEUPS\_0

Bit	Name	R/W	Description
[7:0]	NUMBER_OF_WAKEUPS[7:0]	R/W	Bits[7:0] of [15:0] of an internal 16-bit count of the number of wake-ups (WUC timeouts) the device has gone through. It can be initialized to 0x0000.

Table 54. 0x103: NUMBER\_OF\_WAKEUPS\_1

Bit	Name	R/W	Description
[7:0]	NUMBER_OF_WAKEUPS[15:8]	R/W	Bits[15:8] of [15:0] of an internal 16-bit count of the number of WUC wake-ups the device has gone through. It can be initialized to 0x0000.

Table 55. 0x104: NUMBER\_OF\_WAKEUPS\_IRQ\_THRESHOLD\_0

Bit	Name	R/W	Description
[7:0]	NUMBER_OF_WAKEUPS_IRQ_THRESHOLD[7:0]	R/W	Bits[7:0] of [15:0] (see Table 56). The threshold for the number of wake-ups (WUC timeouts). It is a 16-bit count threshold that is compared against the NUMBER_OF_WAKEUPS parameter. When this threshold is exceeded, the device wakes up in the PHY_OFF state and optionally generates INTERRUPT_NUM_WAKEUPS.

Table 56. 0x105: NUMBER\_OF\_WAKEUPS\_IRQ\_THRESHOLD\_1

Bit	Name	R/W	Description
[7:0]	NUMBER_OF_WAKEUPS_IRQ_THRESHOLD[15:8]	R/W	Bits[15:8] of [15:0] (see Table 55).

Table 57. 0x106: RX\_DWELL\_TIME

Bit	Name	R/W	Description
[7:0]	RX_DWELL_TIME	R/W	When the WUC is used and SWM is enabled, the radio powers up and enables the receiver on the channel defined in the BBRAM and listens for this period of time. If no preamble pattern is detected in this period, the device goes back to sleep. $\text{Receive Dwell Time (s)} = \frac{\text{RX\_DWELL\_TIME} \times 128 \times \text{PARMTIME\_DIVIDER}}{6.5 \text{ MHz}}$

Table 58. 0x107: PARMTIME\_DIVIDER

Bit	Name	R/W	Description
[7:0]	PARMTIME_DIVIDER	R/W	Units of time used to define the RX_DWELL_TIME time period. $\text{Timer Tick Rate} = \frac{128 \times \text{PARMTIME\_DIVIDER}}{6.5 \text{ MHz}}$ <p>A value of 0x33 gives a clock of 995.7 Hz or a period of 1.004 ms.</p>

Table 59. 0x108: SWM\_RSSI\_THRESH

Bit	Name	R/W	Description
[7:0]	SWM_RSSI_THRESH	R/W	This sets the RSSI threshold when in smart wake mode with RSSI detection enabled. $\text{Threshold (dBm)} = \text{SWM\_RSSI\_THRESH} - 107$

Table 60. 0x109: CHANNEL\_FREQ\_0

Bit	Name	R/W	Description
[7:0]	CHANNEL_FREQ[7:0]	R/W	The RF channel frequency in hertz is set according to $\text{Frequency (Hz)} = F_{\text{PFD}} \times \frac{(\text{CHANNEL\_FREQ}[23 : 0])}{2^{16}}$ <p>where <math>F_{\text{PFD}}</math> is the PFD frequency and is equal to 26 MHz.</p>

Table 61. 0x10A: CHANNEL\_FREQ\_1

Bit	Name	R/W	Description
[7:0]	CHANNEL_FREQ[15:8]	R/W	See the CHANNEL_FREQ_0 description in Table 60.

Table 62. 0x10B: CHANNEL\_FREQ\_2

Bit	Name	R/W	Description
[7:0]	CHANNEL_FREQ[23:16]	R/W	See the CHANNEL_FREQ_0 description in Table 60.

Table 63. 0x10C: RADIO\_CFG\_0

Bit	Name	R/W	Description
[7:0]	DATA_RATE[7:0]	R/W	The data rate in bps is set according to $\text{Data Rate (bps)} = \text{DATA\_RATE}[11:0] \times 100$

Table 64. 0x10D: RADIO\_CFG\_1

Bit	Name	R/W	Description
[7:4]	FREQ_DEVIATION[11:8]	R/W	See the FREQ_DEVIATION description in RADIO_CFG_2 (Table 65).
[3:0]	DATA_RATE[11:8]	R/W	See the DATA_RATE description in RADIO_CFG_0 (Table 63).

Table 65. 0x10E: RADIO\_CFG\_2

Bit	Name	R/W	Description
[7:0]	FREQ_DEVIATION[7:0]	R/W	The binary level 2FSK/GFSK/MSK/GMSK frequency deviation in hertz (defined as the frequency difference between carrier frequency and 1/0 tones) is set according to $\text{Frequency Deviation (Hz)} = \text{FREQ\_DEVIATION}[11 : 0] \times 100$

Table 66. 0x10F: RADIO\_CFG\_3

Bit	Name	R/W	Description
[7:0]	DISCRIM_BW[7:0]	R/W	The DISCRIM_BW value sets the bandwidth of the correlator demodulator. See the 2FSK/GFSK/MSK/GMSK Demodulation section for the steps required to set the DISCRIM_BW value.

Table 67. 0x110: RADIO\_CFG\_4

Bit	Name	R/W	Description
[7:0]	POST_DEMOD_BW[7:0]	R/W	For optimum performance, the post-demodulator filter bandwidth should be set close to 0.75 times the data rate. The actual bandwidth of the post-demodulator filter is given by $\text{Post-Demodulator Filter Bandwidth (kHz)} = \text{POST\_DEMOD\_BW} \times 2$ The range of POST_DEMOD_BW is 1 to 255.

Table 68. 0x111: RADIO\_CFG\_5

Bit	Name	R/W	Description
[7:0]	Reserved	R/W	Set to zero.

Table 69. 0x112: RADIO\_CFG\_6

Bit	Name	R/W	Description
[7:2]	SYNTH_LUT_CONFIG_0	R/W	If SYNTH_LUT_CONTROL (Address 0x113, Table 70) = 0 or 2, set SYNTH_LUT_CONFIG_0 = 0. If SYNTH_LUT_CONTROL = 1 or 3, this setting allows the receiver PLL loop bandwidth to be changed to optimize the receiver local oscillator phase noise.
[1:0]	DISCRIM_PHASE[1:0]	R/W	The DISCRIM_PHASE value sets the phase of the correlator demodulator. See the 2FSK/GFSK/MSK/GMSK Demodulation section for the steps required to set the DISCRIM_PHASE value.

Table 70. 0x113: RADIO\_CFG\_7

Bit	Name	R/W	Description										
[7:6]	AGC_LOCK_MODE	R/W	Set to 0: free running 1: manual 2: hold 3: lock after preamble/sync word (only locks on a sync word if PREAMBLE_MATCH = 0)										
[5:4]	SYNTH_LUT_CONTROL	R/W	By default, the synthesizer loop bandwidth is automatically selected from lookup tables (LUT) in ROM memory. A narrow bandwidth is selected in receive to ensure optimum interference rejection, whereas in transmit, the bandwidth is selected based on the data rate and modulation settings. For the majority of applications, these automatically selected PLL loop bandwidths are optimum. However, in some applications, it may be necessary to use custom transmit or receive bandwidths, in which case, various options exist, as follows. <table border="1" data-bbox="771 709 1539 1304"> <thead> <tr> <th>SYNTH_LUT_CONTROL</th> <th>Description</th> </tr> </thead> <tbody> <tr> <td>0</td> <td>Use predefined transmit and receive LUTs. The LUTs are automatically selected from ROM memory on transitioning into the PHY_TX or PHY_RX state.</td> </tr> <tr> <td>1</td> <td>Use custom receive LUT based on SYNTH_LUT_CONFIG_0 and SYNTH_LUT_CONFIG_1. In transmit, the predefined LUT in ROM is used.</td> </tr> <tr> <td>2</td> <td>Use a custom transmit LUT. The custom transmit LUT must be written to the 0x10 to 0x18 packet RAM locations. In receive, the predefined LUT in ROM is used.</td> </tr> <tr> <td>3</td> <td>Use a custom receive LUT based on SYNTH_LUT_CONFIG_0 and SYNTH_LUT_CONFIG_1, and use a custom transmit LUT. The custom transmit LUT must be written to the 0x10 to 0x18 packet RAM locations</td> </tr> </tbody> </table>	SYNTH_LUT_CONTROL	Description	0	Use predefined transmit and receive LUTs. The LUTs are automatically selected from ROM memory on transitioning into the PHY_TX or PHY_RX state.	1	Use custom receive LUT based on SYNTH_LUT_CONFIG_0 and SYNTH_LUT_CONFIG_1. In transmit, the predefined LUT in ROM is used.	2	Use a custom transmit LUT. The custom transmit LUT must be written to the 0x10 to 0x18 packet RAM locations. In receive, the predefined LUT in ROM is used.	3	Use a custom receive LUT based on SYNTH_LUT_CONFIG_0 and SYNTH_LUT_CONFIG_1, and use a custom transmit LUT. The custom transmit LUT must be written to the 0x10 to 0x18 packet RAM locations
SYNTH_LUT_CONTROL	Description												
0	Use predefined transmit and receive LUTs. The LUTs are automatically selected from ROM memory on transitioning into the PHY_TX or PHY_RX state.												
1	Use custom receive LUT based on SYNTH_LUT_CONFIG_0 and SYNTH_LUT_CONFIG_1. In transmit, the predefined LUT in ROM is used.												
2	Use a custom transmit LUT. The custom transmit LUT must be written to the 0x10 to 0x18 packet RAM locations. In receive, the predefined LUT in ROM is used.												
3	Use a custom receive LUT based on SYNTH_LUT_CONFIG_0 and SYNTH_LUT_CONFIG_1, and use a custom transmit LUT. The custom transmit LUT must be written to the 0x10 to 0x18 packet RAM locations												
			Because packet RAM memory is lost in the PHY_SLEEP state, the custom LUT for transmit must be reloaded to packet RAM after waking from the PHY_SLEEP state.										
[3:0]	SYNTH_LUT_CONFIG_1	R/W	If SYNTH_LUT_CONTROL = 0 or 2, set SYNTH_LUT_CONFIG_1 to 0. If SYNTH_LUT_CONTROL = 1 or 3, this setting allows the receiver PLL loop bandwidth to be changed to optimize the receiver local oscillator phase noise.										

Table 71. 0x114: RADIO\_CFG\_8

Bit	Name	R/W	Description	
[7]	PA_SINGLE_DIFF_SEL	R/W	<b>PA_SINGLE_DIFF_SEL</b>	<b>PA</b>
			0	Single-ended PA enabled
			1	Differential PA enabled
[6:3]	PA_LEVEL	R/W	Sets the PA output power. A value of zero sets the minimum RF output power, and a value of 15 sets the maximum PA output power. The PA level can also be set with finer resolution using the PA_LEVEL_MCR setting (Address 0x307). The PA_LEVEL setting is related to the PA_LEVEL_MCR setting by $PA\_LEVEL\_MCR = 4 \times PA\_LEVEL + 3$	
			<b>PA_LEVEL</b>	<b>PA Level (PA_LEVEL_MCR)</b>
			0	Setting 3
			1	Setting 7
			2	Setting 11
	...	...		
	15	Setting 63		
[2:0]	PA_RAMP	R/W	Sets the PA ramp rate. The PA ramps at the programmed rate until it reaches the level indicated by the PA_LEVEL_MCR (Address 0x307) setting. The ramp rate is dependent on the programmed data rate.	
			<b>PA_RAMP</b>	<b>Ramp Rate</b>
			0	Reserved
			1	256 codes per data bit
			2	128 codes per data bit
			3	64 codes per data bit
			4	32 codes per data bit
			5	16 codes per data bit
6	Eight codes per data bit			
7	Four codes per data bit			
			To ensure the correct PA ramp-up and -down timing, the PA ramp rate has a minimum value based on the data rate and the PA_LEVEL or PA_LEVEL_MCR settings. This minimum value is described by $Ramp\ Rate(Codes/Bit) < 10,000 \times \frac{PA\_LEVEL\_MCR[5 : 0]}{DATA\_RATE[11 : 0]}$ where PA_LEVEL_MCR is related to the PA_LEVEL setting by PA_LEVEL_MCR = 4 × PA_LEVEL + 3.	

Table 72. 0x115: RADIO\_CFG\_9

Bit	Name	R/W	Description	
[7:6]	IFBW	R/W	Sets the receiver IF filter bandwidth. Note that setting an IF filter bandwidth of 300 kHz automatically changes the receiver IF frequency from 200 kHz to 300 kHz.	
			<b>IFBW</b>	<b>IF Bandwidth</b>
			0	100 kHz
			1	150 kHz
			2	200 kHz
	3	300 kHz		
[5:3]	MOD_SCHEME	R/W	Sets the transmitter modulation scheme.	
			<b>MOD_SCHEME</b>	<b>Modulation Scheme</b>
			0	Two-level 2FSK/MSK
			1	Two-level GFSK/GSMK
			2	OOK
			3	Carrier only
	4 to 7	Reserved		

Bit	Name	R/W	Description										
[2:0]	DEMOD_SCHEME	R/W	Sets the receiver demodulation scheme.										
			<table border="1"> <thead> <tr> <th>DEMOD_SCHEME</th> <th>Demodulation Scheme</th> </tr> </thead> <tbody> <tr> <td>0</td> <td>2FSK/GFSK/MSK/GMSK</td> </tr> <tr> <td>1</td> <td>Reserved</td> </tr> <tr> <td>2</td> <td>OOK</td> </tr> <tr> <td>3 to 7</td> <td>Reserved</td> </tr> </tbody> </table>	DEMOD_SCHEME	Demodulation Scheme	0	2FSK/GFSK/MSK/GMSK	1	Reserved	2	OOK	3 to 7	Reserved
DEMOD_SCHEME	Demodulation Scheme												
0	2FSK/GFSK/MSK/GMSK												
1	Reserved												
2	OOK												
3 to 7	Reserved												

Table 73. 0x116: RADIO\_CFG\_10

Bit	Name	R/W	Description										
[7:5]	Reserved	R/W	Set to 0.										
[4]	AFC_POLARITY	R/W	Set to 0.										
[3:2]	AFC_SCHEME	R/W	Set to 2.										
[1:0]	AFC_LOCK_MODE	R/W	Sets the AFC mode.										
			<table border="1"> <thead> <tr> <th>AFC_LOCK_MODE</th> <th>Mode</th> </tr> </thead> <tbody> <tr> <td>0</td> <td>Free running: AFC is free running.</td> </tr> <tr> <td>1</td> <td>Disabled: AFC is disabled.</td> </tr> <tr> <td>2</td> <td>Hold AFC: AFC is paused.</td> </tr> <tr> <td>3</td> <td>Lock: AFC locks after the preamble or sync word (only locks on a sync word if PREAMBLE_MATCH = 0).</td> </tr> </tbody> </table>	AFC_LOCK_MODE	Mode	0	Free running: AFC is free running.	1	Disabled: AFC is disabled.	2	Hold AFC: AFC is paused.	3	Lock: AFC locks after the preamble or sync word (only locks on a sync word if PREAMBLE_MATCH = 0).
AFC_LOCK_MODE	Mode												
0	Free running: AFC is free running.												
1	Disabled: AFC is disabled.												
2	Hold AFC: AFC is paused.												
3	Lock: AFC locks after the preamble or sync word (only locks on a sync word if PREAMBLE_MATCH = 0).												

Table 74. 0x117: RADIO\_CFG\_11

Bit	Name	R/W	Description												
[7:4]	AFC_KP	R/W	Sets the AFC PI controller proportional gain in 2FSK/GFSK/MSK/GMSK; the recommended value is 0x3. In OOK demodulation, this setting is used to control the OOK threshold loop; the recommended value is 0x3.												
			<table border="1"> <thead> <tr> <th>AFC_KP</th> <th>Proportional Gain</th> </tr> </thead> <tbody> <tr> <td>0</td> <td>2<sup>0</sup></td> </tr> <tr> <td>1</td> <td>2<sup>1</sup></td> </tr> <tr> <td>2</td> <td>2<sup>2</sup></td> </tr> <tr> <td>...</td> <td>...</td> </tr> <tr> <td>15</td> <td>2<sup>15</sup></td> </tr> </tbody> </table>	AFC_KP	Proportional Gain	0	2 <sup>0</sup>	1	2 <sup>1</sup>	2	2 <sup>2</sup>	...	...	15	2 <sup>15</sup>
AFC_KP	Proportional Gain														
0	2 <sup>0</sup>														
1	2 <sup>1</sup>														
2	2 <sup>2</sup>														
...	...														
15	2 <sup>15</sup>														
[3:0]	AFC_KI	R/W	Sets the AFC PI controller integral gain in 2FSK/GFSK/MSK/GMSK; the recommended value is 0x7. In OOK modulation, this setting is used to control the OOK threshold loop; the recommended value is 0x6.												
			<table border="1"> <thead> <tr> <th>AFC_KI</th> <th>Integral Gain</th> </tr> </thead> <tbody> <tr> <td>0</td> <td>2<sup>0</sup></td> </tr> <tr> <td>1</td> <td>2<sup>1</sup></td> </tr> <tr> <td>2</td> <td>2<sup>2</sup></td> </tr> <tr> <td>...</td> <td>...</td> </tr> <tr> <td>15</td> <td>2<sup>15</sup></td> </tr> </tbody> </table>	AFC_KI	Integral Gain	0	2 <sup>0</sup>	1	2 <sup>1</sup>	2	2 <sup>2</sup>	...	...	15	2 <sup>15</sup>
AFC_KI	Integral Gain														
0	2 <sup>0</sup>														
1	2 <sup>1</sup>														
2	2 <sup>2</sup>														
...	...														
15	2 <sup>15</sup>														

Table 75. 0x118: IMAGE\_REJECT\_CAL\_PHASE

Bit	Name	R/W	Description
[7]	Reserved	R/W	Set to 0
[6:0]	IMAGE_REJECT_CAL_PHASE	R/W	Sets the I/Q phase adjustment

Table 76. 0x119: IMAGE\_REJECT\_CAL\_AMPLITUDE

Bit	Name	R/W	Description
[7]	Reserved	R/W	Set to 0
[6:0]	IMAGE_REJECT_CAL_AMPLITUDE	R/W	Sets the I/Q amplitude adjustment

Table 77. 0x11A: MODE\_CONTROL

Bit	Name	R/W	Description
[7]	SWM_EN	R/W	1: smart wake mode enabled. 0: smart wake mode disabled.
[6]	BB_CAL	R/W	1: IF filter calibration enabled. 0: IF filter calibration disabled. IF filter calibration is automatically performed on the transition from the PHY_OFF state to the PHY_ON state if this bit is set.
[5]	SWM_RSSI_QUAL	R/W	1: RSSI qualify in low power mode enabled. 0: RSSI qualify in low power mode disabled.
[4]	TX_TO_RX_AUTO_TURNAROUND	R/W	If TX_TO_RX_AUTO_TURNAROUND = 1, the device automatically transitions to the PHY_RX state at the end of a packet transmission, on the same RF channel frequency. If TX_TO_RX_AUTO_TURNAROUND = 0, this operation is disabled. TX_TO_RX_AUTO_TURNAROUND is only available in packet mode.
[3]	RX_TO_TX_AUTO_TURNAROUND	R/W	If RX_TO_TX_AUTO_TURNAROUND = 1, the device automatically transitions to the PHY_TX state at the end of a valid packet reception, on the same RF channel frequency. If RX_TO_TX_AUTO_TURNAROUND = 0, this operation is disabled. RX_TO_TX_AUTO_TURNAROUND is only available in packet mode.
[2]	CUSTOM_TRX_SYNTH_LOCK_TIME_EN	R/W	1: use the custom synthesizer lock time defined in Register 0x13E and Register 0x13F. 0: default synthesizer lock time.
[1]	EXT_LNA_EN	R/W	1: external LNA enable signal on ATB4 is enabled. The signal is logic high while the ADF7023 is in the PHY_RX state and logic low while in any other nonsleep state. 0: external LNA enable signal on ATB4 is disabled.
[0]	EXT_PA_EN	R/W	1: external PA enable signal on ATB3 is enabled. The signal is logic high while the ADF7023 is in the PHY_TX state and logic low while in any other nonsleep state. 0: external PA enable signal on ADCIN_ATB3 is disabled.

Table 78. 0x11B: PREAMBLE\_MATCH

Bit	Name	R/W	Description																		
[7:4]	Reserved	R/W	Set to 0																		
[3:0]	PREAMBLE_MATCH	R/W	<table border="1"> <thead> <tr> <th>PREAMBLE_MATCH</th> <th>Description</th> </tr> </thead> <tbody> <tr> <td>12</td> <td>0 errors allowed.</td> </tr> <tr> <td>11</td> <td>One erroneous bit-pair allowed in 12 bit-pairs.</td> </tr> <tr> <td>10</td> <td>Two erroneous bit-pairs allowed in 12 bit-pairs.</td> </tr> <tr> <td>9</td> <td>Three erroneous bit-pairs allowed in 12 bit-pairs.</td> </tr> <tr> <td>8</td> <td>Four erroneous bit-pairs allowed in 12 bit-pairs.</td> </tr> <tr> <td>0</td> <td>Preamble detection disabled.</td> </tr> <tr> <td>1 to 7</td> <td>Not recommended.</td> </tr> <tr> <td>13 to 15</td> <td>Reserved.</td> </tr> </tbody> </table>	PREAMBLE_MATCH	Description	12	0 errors allowed.	11	One erroneous bit-pair allowed in 12 bit-pairs.	10	Two erroneous bit-pairs allowed in 12 bit-pairs.	9	Three erroneous bit-pairs allowed in 12 bit-pairs.	8	Four erroneous bit-pairs allowed in 12 bit-pairs.	0	Preamble detection disabled.	1 to 7	Not recommended.	13 to 15	Reserved.
PREAMBLE_MATCH	Description																				
12	0 errors allowed.																				
11	One erroneous bit-pair allowed in 12 bit-pairs.																				
10	Two erroneous bit-pairs allowed in 12 bit-pairs.																				
9	Three erroneous bit-pairs allowed in 12 bit-pairs.																				
8	Four erroneous bit-pairs allowed in 12 bit-pairs.																				
0	Preamble detection disabled.																				
1 to 7	Not recommended.																				
13 to 15	Reserved.																				



Table 79. 0x11C: SYMBOL\_MODE

Bit	Name	R/W	Description								
[7]	Reserved	R/W	Set to 0.								
[6]	MANCHESTER_ENC	R/W	1: Manchester encoding and decoding enabled. 0: Manchester encoding and decoding disabled.								
[5]	PROG_CRC_EN	R/W	1: programmable CRC selected. 0: default CRC selected.								
[4]	EIGHT_TEN_ENC	R/W	1: 8b/10b encoding and decoding enabled. 0: 8b/10b encoding and decoding disabled.								
[3]	DATA_WHITENING	R/W	1: data whitening and dewhitening enabled. 0: data whitening and dewhitening disabled.								
[2:0]	SYMBOL_LENGTH	R/W	<table border="1"> <thead> <tr> <th>SYMBOL_LENGTH</th> <th>Description</th> </tr> </thead> <tbody> <tr> <td>0</td> <td>8-bit (recommended except when 8b/10b is being used).</td> </tr> <tr> <td>1</td> <td>10-bit (for 8b/10b encoding).</td> </tr> <tr> <td>2 to 7</td> <td>Reserved.</td> </tr> </tbody> </table>	SYMBOL_LENGTH	Description	0	8-bit (recommended except when 8b/10b is being used).	1	10-bit (for 8b/10b encoding).	2 to 7	Reserved.
SYMBOL_LENGTH	Description										
0	8-bit (recommended except when 8b/10b is being used).										
1	10-bit (for 8b/10b encoding).										
2 to 7	Reserved.										

Table 80. 0x11D: PREAMBLE\_LEN

Bit	Name	R/W	Description
[7:0]	PREAMBLE_LEN	R/W	Length of preamble in bytes. Example: a value of decimal 3 results in a preamble of 24 bits.

Table 81. 0x11E: CRC\_POLY\_0

Bit	Name	R/W	Description
[7:0]	CRC_POLY[7:0]	R/W	Lower byte of CRC_POLY[15:0], which sets the CRC polynomial.

Table 82. 0x11F: CRC\_POLY\_1

Bit	Name	R/W	Description
[7:0]	CRC_POLY[15:8]	R/W	Upper byte of CRC_POLY[15:0], which sets the CRC polynomial. See the Packet Mode section for more details on how to configure a CRC polynomial.

Table 83. 0x120: SYNC\_CONTROL

Bit	Name	R/W	Description										
[7:6]	SYNC_ERROR_TOL	R/W	<p>Sets the sync word error tolerance in bits.</p> <table border="1"> <thead> <tr> <th>SYNC_ERROR_TOL</th> <th>Bit Error Tolerance</th> </tr> </thead> <tbody> <tr> <td>0</td> <td>0 bit errors allowed.</td> </tr> <tr> <td>1</td> <td>One bit error allowed.</td> </tr> <tr> <td>2</td> <td>Two bit errors allowed.</td> </tr> <tr> <td>3</td> <td>Three bit errors allowed.</td> </tr> </tbody> </table>	SYNC_ERROR_TOL	Bit Error Tolerance	0	0 bit errors allowed.	1	One bit error allowed.	2	Two bit errors allowed.	3	Three bit errors allowed.
SYNC_ERROR_TOL	Bit Error Tolerance												
0	0 bit errors allowed.												
1	One bit error allowed.												
2	Two bit errors allowed.												
3	Three bit errors allowed.												
[5]	Reserved	R/W	Set to 0.										
[4:0]	SYNC_WORD_LENGTH	R/W	<p>Sets the sync word length in bits; 24 bits is the maximum. Note that the sync word matching length can be any value up to 24 bits, but the transmitted sync word pattern is a multiple of eight bits. Therefore, for non-byte-length sync words, the transmitted sync pattern should be filled out with the preamble pattern.</p> <table border="1"> <thead> <tr> <th>SYNC_WORD_LENGTH</th> <th>Length in Bits</th> </tr> </thead> <tbody> <tr> <td>0</td> <td>0</td> </tr> <tr> <td>1</td> <td>1</td> </tr> <tr> <td>...</td> <td>...</td> </tr> <tr> <td>24</td> <td>24</td> </tr> </tbody> </table>	SYNC_WORD_LENGTH	Length in Bits	0	0	1	1	...	...	24	24
SYNC_WORD_LENGTH	Length in Bits												
0	0												
1	1												
...	...												
24	24												

Table 84. 0x121: SYNC\_BYTE\_0

Bit	Name	R/W	Description
[7:0]	SYNC_BYTE[23:16]	R/W	Upper byte of the sync word pattern. The sync word pattern is transmitted most significant bit first starting with SYNC_BYTE_0. For nonbyte length sync words, the remainder of the least significant byte should be stuffed with the preamble. If SYNC_WORD_LENGTH length is >16 bits, SYNC_BYTE_0, SYNC_BYTE_1, and SYNC_BYTE_2 are all transmitted for a total of 24 bits. If SYNC_WORD_LENGTH is between 8 and 15, SYNC_BYTE_1 and SYNC_BYTE_2 are transmitted. If SYNC_WORD_LENGTH is between 1 and 7, SYNC_BYTE_2 is transmitted for a total of eight bits. If the SYNC WORD LENGTH is 0, no sync bytes are transmitted.

Table 85. 0x122: SYNC\_BYTE\_1

Bit	Name	R/W	Description
[7:0]	SYNC_BYTE[15:8]	R/W	Middle byte of the sync word pattern.

Table 86. 0x123: SYNC\_BYTE\_2

Bit	Name	R/W	Description
[7:0]	SYNC_BYTE[7:0]	R/W	Lower byte of the sync word pattern.

Table 87. 0x124: TX\_BASE\_ADR

Bit	Name	R/W	Description
[7:0]	TX_BASE_ADR	R/W	Address in packet RAM of the transmit packet. This address indicates to the communications processor the location of the first byte of the transmit packet.

Table 88. 0x125: RX\_BASE\_ADR

Bit	Name	R/W	Description
[7:0]	RX_BASE_ADR	R/W	Address in packet RAM of the receive packet. The communications processor writes any qualified received packet to packet RAM, starting at this memory location.

Table 89. 0x126: PACKET\_LENGTH\_CONTROL

Bit	Name	R/W	Description										
[7]	DATA_BYTE	R/W	Over-the-air arrangement of each transmitted packet RAM byte. A byte is transmitted either MSB or LSB first. The same setting should be used on the Tx and Rx sides of the link. 1: data byte MSB first. 0: data byte LSB first.										
[6]	PACKET_LEN	R/W	1: fixed packet length mode. Fixed packet length in Tx and Rx modes, given by PACKET_LENGTH_MAX. 0: variable packet length mode. In Rx mode, packet length is given by the first byte in packet RAM. In Tx mode, the packet length is given by PACKET_LENGTH_MAX.										
[5]	CRC_EN	R/W	1: append CRC in transmit mode. Check CRC in receive mode. 0: no CRC addition in transmit mode. No CRC check in receive mode.										
[4:3]	DATA_MODE	R/W	Sets the ADF7023 to packet mode or sport mode for transmit and receive data. <table border="1" data-bbox="711 1661 1498 1877"> <thead> <tr> <th>DATA_MODE</th> <th>Description</th> </tr> </thead> <tbody> <tr> <td>0</td> <td>Packet mode enabled.</td> </tr> <tr> <td>1</td> <td>Sport mode enabled. GP4 interrupt enabled on preamble detection. Rx data enabled on preamble detection.</td> </tr> <tr> <td>2</td> <td>Sport mode enabled. GP4 interrupt enabled on sync word detection. Rx data enabled on preamble detection.</td> </tr> <tr> <td>3</td> <td>Unused.</td> </tr> </tbody> </table>	DATA_MODE	Description	0	Packet mode enabled.	1	Sport mode enabled. GP4 interrupt enabled on preamble detection. Rx data enabled on preamble detection.	2	Sport mode enabled. GP4 interrupt enabled on sync word detection. Rx data enabled on preamble detection.	3	Unused.
DATA_MODE	Description												
0	Packet mode enabled.												
1	Sport mode enabled. GP4 interrupt enabled on preamble detection. Rx data enabled on preamble detection.												
2	Sport mode enabled. GP4 interrupt enabled on sync word detection. Rx data enabled on preamble detection.												
3	Unused.												

Bit	Name	R/W	Description
[2:0]	LENGTH_OFFSET	R/W	Offset value in bytes that is added to the received packet length field value (in variable length packet mode) so that the communications processor knows the correct number of bytes to read. The communications processor calculates the actual received payload length as $Rx\ Payload\ Length = Length + LENGTH\_OFFSET - 4$ where <i>Length</i> is the length field (the first byte in the received payload).

Table 90. 0x127: PACKET\_LENGTH\_MAX

Bit	Name	R/W	Description
[7:0]	PACKET_LENGTH_MAX	R/W	If variable packet length mode is used (PACKET_LENGTH_CONTROL = 0), PACKET_LENGTH_MAX sets the maximum receive packet length in bytes. If fixed packet length mode is used (PACKET_LENGTH_CONTROL = 1), PACKET_LENGTH_MAX sets the length of the fixed transmit and receive packet in bytes. Note that the packet length is defined as the number of bytes from the end of the sync word to the start of the CRC. It also does not include the LENGTH_OFFSET value.

Table 91. 0x128: STATIC\_REG\_FIX

Bit	Name	R/W	Description																					
[7:0]	STATIC_REG_FIX	R/W	The ADF7023 has the ability to implement automatic static register fixes from BBRAM memory to MCR memory. This feature allows a maximum of nine MCR registers to be programmed via BBRAM memory. This feature is useful if MCR registers must be configured for optimum receiver performance in low power mode. The STATIC_REG_FIX value is an address pointer to any BBRAM memory address between 0x12A and 0x13D. For example, to point to BBRAM Address 0x12B, set STATIC_REG_FIX = 0x2B. <ul style="list-style-type: none"> <li>If STATIC_REG_FIX = 0x00, then static register fixes are disabled.</li> <li>If STATIC_REG_FIX is nonzero, the communications processor looks for the MCR address and corresponding data at the BBRAM address beginning at STATIC_REG_FIX.</li> </ul> Example: write 0x46 to MCR Register 0x35E and write 0x78 to MCR Register 0x35F. Set STATIC_REG_FIX = 0x2B. <table border="1" data-bbox="479 1108 1565 1333"> <thead> <tr> <th>BBRAM Register</th> <th>Data</th> <th>Description</th> </tr> </thead> <tbody> <tr> <td>0x128 (STATIC_REG_FIX)</td> <td>0x2B</td> <td>Pointer to BBRAM Address 0x12B</td> </tr> <tr> <td>0x12B</td> <td>0x5E</td> <td>MCR Address 1</td> </tr> <tr> <td>0x12C</td> <td>0x46</td> <td>Data to write to MCR Address 1</td> </tr> <tr> <td>0x12D</td> <td>0x5F</td> <td>MCR Address 2</td> </tr> <tr> <td>0x12E</td> <td>0x78</td> <td>Data to write to MCR Address 2</td> </tr> <tr> <td>0x12F</td> <td>0x00</td> <td>Ends static MCR register fixes</td> </tr> </tbody> </table>	BBRAM Register	Data	Description	0x128 (STATIC_REG_FIX)	0x2B	Pointer to BBRAM Address 0x12B	0x12B	0x5E	MCR Address 1	0x12C	0x46	Data to write to MCR Address 1	0x12D	0x5F	MCR Address 2	0x12E	0x78	Data to write to MCR Address 2	0x12F	0x00	Ends static MCR register fixes
BBRAM Register	Data	Description																						
0x128 (STATIC_REG_FIX)	0x2B	Pointer to BBRAM Address 0x12B																						
0x12B	0x5E	MCR Address 1																						
0x12C	0x46	Data to write to MCR Address 1																						
0x12D	0x5F	MCR Address 2																						
0x12E	0x78	Data to write to MCR Address 2																						
0x12F	0x00	Ends static MCR register fixes																						

Table 92. 0x129: ADDRESS\_MATCH\_OFFSET

Bit	Name	R/W	Description
[7:0]	ADDRESS_MATCH_OFFSET	R/W	Location of first byte of address information in packet RAM

Table 93. 0x12A: ADDRESS\_LENGTH

Bit	Name	R/W	Description
[7:0]	ADDRESS_LENGTH	R/W	Number of bytes in the first address field ( $N_{ADR\_1}$ ). Set to zero if address filtering is not being used.

Table 94. 0x12B to 0x137: Address Filtering (or Static Register Fix)

Address	Bit	R/W	Description
0x12B	[7:0]	R/W	Address 1 Match Byte 0.
0x12C	[7:0]	R/W	Address 1 Mask Byte 0.
0x12D	[7:0]	R/W	Address 1 Match Byte 1.
0x12E	[7:0]	R/W	Address 1 Mask Byte 1.
...			...
	[7:0]	R/W	Address 1 Match Byte $N_{ADR\_1}$ .
	[7:0]	R/W	Address 1 Mask Byte $N_{ADR\_1}$ .
	[7:0]	R/W	0x00 to end or number of bytes in the second address field ( $N_{ADR\_2}$ )

Table 95. 0x138: RSSI\_WAIT\_TIME

Bit	Name	R/W	Description
[7:0]	RSSI_WAIT_TIME	R/W	Settling time in $\mu$ s before taking an RSSI measurement in SWM or when using CMD_GET_RSSI. A value of 0xA7 can be used safely in all situations; however, this can be reduced for particular implementations.

Table 96. 0x139: TESTMODES

Bit	Name	R/W	Description
[7]	EXT_PA_LNA_ATB_CONFIG	R/W	1: ATB3 and ATB4 used for control of extPA and extLNA, respectively (1.8 V logic outputs). 0: ATB1 and ATB2 used for control of extPA and extLNA, respectively ( $V_{DD}$ logic outputs). Must also enable external PA/LNA in Register 0x11A.
[6:4]	Reserved	R/W	Set to 0.
[3]	PER_IRQ_SELF_CLEAR	R/W	1: Automatic clear of INTERRUPT_TX_EOF and INTERRUPT_CORRECT_CRC. 0: Normal operation.
[2]	PER_ENABLE	R/W	1: Packet error rate enabled. 0: Packet error rate disabled.
[1]	CONTINUOUS_TX	R/W	1: Restart TX after transmitting a packet. 0: Normal end of TX.
[0]	CONTINUOUS_RX	R/W	1: Restart RX after transmitting a packet. 0: Normal end of RX.

Table 97. 0x13A: TRANSITION\_CLOCK\_DIV

Bit	Name	R/W	Description
[7:0]	TRANSITION_CLOCK_DIV	R/W	0x00: Normal transition times. 0x01: Fast transition times. 0x04: Normal transition times. Else: Reserved.

Table 98. 0x13E: RX\_SYNTH\_LOCK\_TIME

Bit	Name	R/W	Description
[7:0]	RX_SYNTH_LOCK_TIME	R/W	Allows the use of a custom synthesizer lock time counter in receive mode in conjunction with the CUSTOM_TRX_SYNTH_LOCK_TIME_EN setting in the MODE_CONTROL register. Applies after VCO calibration is complete. Each bit equates to a 2 $\mu$ s increment.

Table 99. 0x13F: TX\_SYNTH\_LOCK\_TIME

Bit	Name	R/W	Description
[7:0]	TX_SYNTH_LOCK_TIME	R/W	Allows the use of a custom synthesizer lock time counter in transmit mode in conjunction with the CUSTOM_TRX_SYNTH_LOCK_TIME_EN setting in the MODE_CONTROL register. Applies after VCO calibration is complete. Each bit equates to a 2 $\mu$ s increment.

## MCR REGISTER DESCRIPTION

The MCR register settings are not retained when the device enters the PHY\_SLEEP state.

Table 100. 0x307: PA\_LEVEL\_MCR

Bit	Name	R/W	Reset	Description
[5:0]	PA_LEVEL_MCR	R/W	0	Power amplifier level. If PA ramp is enabled, the PA ramps to this target level. The PA level can be set in the 0 to 63 range. The PA level (with less resolution) can also be set via the BBRAM; therefore, the MCR setting should be used only if more resolution is required.

Table 101. 0x30C: WUC\_CONFIG\_HIGH

Bit	Name	R/W	Reset	Description																																	
[7]	Reserved	W	0	Set to 0.																																	
[6:3]	RCOSC_COARSE_CAL_VALUE	W	0	<table border="1"> <thead> <tr> <th>RCOSC_COARSE_CAL_VALUE</th> <th>Change in RC Oscillator Frequency</th> <th>Coarse Tune State</th> </tr> </thead> <tbody> <tr><td>0000</td><td>+83%</td><td>State 10</td></tr> <tr><td>0001</td><td>+66%</td><td>State 9</td></tr> <tr><td>1000</td><td>+50%</td><td>State 8</td></tr> <tr><td>1001</td><td>+33%</td><td>State 7</td></tr> <tr><td>1100</td><td>+16%</td><td>State 6</td></tr> <tr><td>1101</td><td>0%</td><td>State 5</td></tr> <tr><td>1110</td><td>-16%</td><td>State 4</td></tr> <tr><td>1111</td><td>-33%</td><td>State 3</td></tr> <tr><td>0110</td><td>-50%</td><td>State 2</td></tr> <tr><td>0111</td><td>-66%</td><td>State 1</td></tr> </tbody> </table>	RCOSC_COARSE_CAL_VALUE	Change in RC Oscillator Frequency	Coarse Tune State	0000	+83%	State 10	0001	+66%	State 9	1000	+50%	State 8	1001	+33%	State 7	1100	+16%	State 6	1101	0%	State 5	1110	-16%	State 4	1111	-33%	State 3	0110	-50%	State 2	0111	-66%	State 1
RCOSC_COARSE_CAL_VALUE	Change in RC Oscillator Frequency	Coarse Tune State																																			
0000	+83%	State 10																																			
0001	+66%	State 9																																			
1000	+50%	State 8																																			
1001	+33%	State 7																																			
1100	+16%	State 6																																			
1101	0%	State 5																																			
1110	-16%	State 4																																			
1111	-33%	State 3																																			
0110	-50%	State 2																																			
0111	-66%	State 1																																			
[2:0]	WUC_PRESCALER	W	0	<table border="1"> <thead> <tr> <th>WUC_PRESCALER</th> <th>32.768 kHz Divider</th> <th>Tick Period</th> </tr> </thead> <tbody> <tr><td>0</td><td>1</td><td>30.52 <math>\mu</math>s</td></tr> <tr><td>1</td><td>4</td><td>122.1 <math>\mu</math>s</td></tr> <tr><td>2</td><td>8</td><td>244.1 <math>\mu</math>s</td></tr> <tr><td>3</td><td>16</td><td>488.3 <math>\mu</math>s</td></tr> <tr><td>4</td><td>128</td><td>3.91 ms</td></tr> <tr><td>5</td><td>1024</td><td>31.25 ms</td></tr> <tr><td>6</td><td>8192</td><td>250 ms</td></tr> <tr><td>7</td><td>65,536</td><td>2000 ms</td></tr> </tbody> </table>	WUC_PRESCALER	32.768 kHz Divider	Tick Period	0	1	30.52 $\mu$ s	1	4	122.1 $\mu$ s	2	8	244.1 $\mu$ s	3	16	488.3 $\mu$ s	4	128	3.91 ms	5	1024	31.25 ms	6	8192	250 ms	7	65,536	2000 ms						
WUC_PRESCALER	32.768 kHz Divider	Tick Period																																			
0	1	30.52 $\mu$ s																																			
1	4	122.1 $\mu$ s																																			
2	8	244.1 $\mu$ s																																			
3	16	488.3 $\mu$ s																																			
4	128	3.91 ms																																			
5	1024	31.25 ms																																			
6	8192	250 ms																																			
7	65,536	2000 ms																																			

Register WUC\_CONFIG\_LOW should never be written to without updating Register WUC\_CONFIG\_HIGH first.

Table 102. 0x30D: WUC\_CONFIG\_LOW

Bit	Name	R/W	Reset	Description
[7]	Reserved	W	0	Set to 0.
[6]	WUC_RCOSC_EN	W	0	1: enable RCOSC32K. 0: disable RCOSC32K.
[5]	WUC_XOSC32K_EN	W	0	1: enable XOSC32K. 0: disable XOSC32K.
[4]	WUC_CLKSEL	W	0	Select the WUC timer clock source. 1: RC 32.768 kHz oscillator. 0: external crystal oscillator.
[3]	WUC_BBRAM_EN	W	0	1: enable power to the BBRAM during the PHY_SLEEP state. 0: disable power to the BBRAM during the PHY_SLEEP state.
[2:1]	Reserved	W	0	Set to 0.
[0]	WUC_ARM	W	0	1: enable wake-up on a WUC timeout event. 0: disable wake-up on a WUC timeout event.

Updates to Register WUC\_VALUE\_HIGH become effective only after Register WUC\_VALUE\_LOW is written to.

Table 103. 0x30E: WUC\_VALUE\_HIGH

Bit	Name	R/W	Reset	Description
[7:0]	WUC_TIMER_VALUE[15:8]	W	0	WUC timer reload value, Bits[15:8] of [15:0]. A wake-up event is triggered when the WUC unit is enabled and the timer has counted down to 0. The timer is clocked with the prescaler output rate. An update to this register becomes effective only after WUC_VALUE_LOW is written.

Register WUC\_VALUE\_LOW should never be written to without updating register WUC\_VALUE\_HIGH first.

Table 104. 0x30F: WUC\_VALUE\_LOW

Bit	Name	R/W	Reset	Description
[7:0]	WUC_TIMER_VALUE[7:0]	W	0	WUC timer reload value, Bits[7:0] of [15:0]. A wake-up event is triggered when the WUC unit is enabled and the timer has counted down to 0. The timer is clocked with the prescaler output rate.

Table 105. 0x310: WUC\_FLAG\_RESET

Bit	Name	R/W	Reset	Description
[1]	WUC_RCOSC_CAL_EN	R/W	0	1: enable. 0: disable RCOSC32K calibration.
[0]	WUC_FLAG_RESET	R/W		1: reset the WUC_TMR_PRIM_TOFLAG and WUC_PORFLAG bits (Address 0x311, Table 106). 0: normal operation.

Table 106. 0x311: WUC\_STATUS

Bit	Name	R/W	Reset	Description	
[7]	Reserved		R	0	Reserved.
[6]	WUC_RCOSC_CAL_ERROR		R	0	1: RCOSC32K calibration exited with error 0: without error (only valid if WUC_RCOSC_CAL_EN = 1).
[5]	WUC_RCOSC_CAL_READY		R	0	1: RCOSC32K calibration finished 0: in progress (only valid if WUC_RCOSC_CAL_EN = 1).
[4]	XOSC32K_RDY		R	0	1: XOSC32K oscillator has settled 0: not settled (only valid if WUC_XOSC32K_EN = 1).
[3]	XOSC32K_OUT		R	0	Output signal of the XOSC32K oscillator (instantaneous).
[2]	WUC_PORFLAG		R	0	1: chip cold start event has been registered. 0: not registered.
[1]	WUC_TMR_PRIM_TOFLAG		R	0	1: WUC timeout event has been registered. 0: not registered (the output of a latch triggered by a timeout event).
[0]	WUC_TMR_PRIM_TOEVENT		R	0	1: WUC timeout event is present. 0: not present (this bit is set when the counter reaches 0; it is not latched).

Table 107. 0x312: RSSI\_READBACK

Bit	Name	R/W	Reset	Description	
[7:0]	RSSI_READBACK		R	0	Receive input power. After reception of a packet, the RSSI_READBACK value is valid. $RSSI (dBm) = RSSI\_READBACK - 107$

Table 108. 0x315: MAX\_AFC\_RANGE

Bit	Name	R/W	Reset	Description	
[7:0]	MAX_AFC_RANGE	R/W		50	Limits the AFC pull-in range. Automatically set by the communications processor on transitioning into the PHY_RX state. The range is set equal to half the IF bandwidth. Example: IF bandwidth = 200 kHz, AFC pull-in range = $\pm 100$ kHz (MAX_AFC_RANGE = 100).

Table 109. 0x319: IMAGE\_REJECT\_CAL\_CONFIG

Bit	Name	R/W	Reset	Description	
[7:6]	Reserved		R/W	0	
[5]	IMAGE_REJECT_CAL_OVWRT_EN		R/W	0	Override control for image reject calibration results.
[4:3]	IMAGE_REJECT_FREQUENCY		R/W	0	Set the fundamental frequency of the IR calibration signal source. A harmonic of this frequency can be used as an internal RF signal source for the image rejection calibration. 0: IR calibration source disabled in XTAL divider 1: IR calibration source fundamental frequency = XTAL/4 2: IR calibration source fundamental frequency = XTAL/8 3: IR calibration source fundamental frequency = XTAL/16
[2:0]	IMAGE_REJECT_POWER		R/W	0	Set power level of IR calibration source. 0: IR calibration source disabled at mixer input 1: power level = min 2: power level = min 3: power level = min $\times$ 2 4: power level = min $\times$ 2 5: power level = min $\times$ 3 6: power level = min $\times$ 3 7: power level = min $\times$ 4

Table 110. 0x322: CHIP\_SHUTDOWN

Bit	Name	R/W	Reset	Description
[7:1]	Reserved	R/W	0	
[0]	CHIP_SHTDN_REQ	R/W	0	WUC chip-state control flag. 0: remain in active state. 1: invoke chip shutdown. $\overline{CS}$ must also be high to initiate a shutdown.

Table 111. 0x324: POWERDOWN\_RX

Bit	Name	R/W	Reset	Description
[7:5]	Reserved	R/W	0	
[4]	ADC_PD_N	R/W	0	1: ADC enabled 0: ADC disabled
[3]	RSSI_PD_N	R/W	0	1: RSSI enabled 0: RSSI disabled
[2]	RXBBFILT_PD_N	R/W	0	1: IF filter enabled 0: IF filter disabled
[1]	RXMIXER_PD_N	R/W	0	1: mixer enabled 0: mixer disabled
[0]	LNA_PD_N	R/W	0	1: LNA enabled 0: LNA disabled

Table 112. 0x325: POWERDOWN\_AUX

Bit	Name	R/W	Reset	Description
[7:2]	Reserved	R/W	0	
[1]	TEMPMON_PD_EN	R/W	0	1: enable 0: disable temperature monitor
[0]	BATTMON_PD_EN	R/W	0	1: enable 0: disable battery monitor

Table 113. 0x327: ADC\_READBACK\_HIGH

Bit	Name	R/W	Reset	Description
[7:6]	Reserved	R	0	
[5:0]	ADC_READBACK[7:2]	R	0	ADC readback of MSBs

Table 114. 0x328: ADC\_READBACK\_LOW

Bit	Name	R/W	Reset	Description
[7:6]	ADC_READBACK[1:0]	R	0	ADC readback of LSBs
[5:0]	Reserved	R	0	

Table 115. 0x32D: BATTERY\_MONITOR\_THRESHOLD\_VOLTAGE

Bit	Name	R/W	Reset	Description
[7:5]	Reserved	R/W	0	
[4:0]	BATTMON_VOLTAGE	R/W	0	The battery monitor threshold voltage sets the alarm level for the battery monitor. The alarm is raised by the interrupt. Battery monitor trip voltage, $V_{TRIP} = 1.7\text{ V} + 62\text{ mV} \times \text{BATTMON\_VOLTAGE}$ .

Table 116. 0x32E: EXT\_UC\_CLK\_DIVIDE

Bit	Name	R/W	Reset	Description
[7:4]	Reserved	R/W	0	
[3:0]	EXT_UC_CLK_DIVIDE	R/W	4	Optional output clock frequency on XOSC32KP_GP5_ATB1. Output frequency = XTAL/EXT_UC_CLK_DIVIDE. To disable, set EXT_UC_CLK_DIVIDE = 0.

Table 117. 0x32F: AGC\_CLK\_DIVIDE

Bit	Name	R/W	Reset	Description
[7:0]	AGC_CLOCK_DIVIDE	R/W	40	AGC clock divider for 2FSK/GFSK/MSK/GMSK mode. The AGC rate is (26 MHz/(16 × AGC_CLK_DIVIDE)).

Table 118. 0x336: INTERRUPT\_SOURCE\_0

Bit	Name	R/W	Reset	Description
[7]	INTERRUPT_NUM_WAKEUPS	R/W	0	Asserted when the number of WUC wake-ups (NUMBER_OF_WAKEUPS[15:0]) has reached the threshold (NUMBER_OF_WAKEUPS_IRQ_THRESHOLD[15:0])
[6]	INTERRUPT_SWM_RSSI_DET	R/W	0	Asserted when the measured RSSI during smart wake mode has exceeded the RSSI threshold value (SWM_RSSI_THRESH, Address 0x108)
[5]	INTERRUPT_AES_DONE	R/W	0	Asserted when an AES encryption or decryption command is complete; available only when the AES firmware module has been loaded to the ADF7023 program RAM
[4]	INTERRUPT_TX_EOF	R/W	0	Asserted when a packet has finished transmitting (packet mode only)
[3]	INTERRUPT_ADDRESS_MATCH	R/W	0	Asserted when a received packet has a valid address match (packet mode only)
[2]	INTERRUPT_CRC_CORRECT	R/W	0	Asserted when a received packet has the correct CRC (packet mode only)
[1]	INTERRUPT_SYNC_DETECT	R/W	0	Asserted when a qualified sync word has been detected in the received packet
[0]	INTERRUPT_PREAMBLE_DETECT	R/W	0	Asserted when a qualified preamble has been detected in the received packet

Table 119. 0x337: INTERRUPT\_SOURCE\_1

Bit	Name	R/W	Reset	Description
[7]	BATTERY_ALARM	R/W	0	Battery voltage dropped below the user-set threshold value.
[6]	CMD_READY	R/W	0	Communications processor ready to accept a new command.
[5]	Unused	R/W	0	
[4]	WUC_TIMEOUT	R/W	0	Wake-up timer has timed out.
[3]	Unused	R/W	0	
[2]	Unused	R/W	0	
[1]	SPI_READY	R/W	0	SPI ready for access.
[0]	CMD_FINISHED	R/W	0	Command has finished.

Table 120. 0x338: CALIBRATION\_CONTROL

Bit	Name	R/W	Reset	Description
[7:2]	Reserved	R/W	0	
[1]	SYNTH_CAL_EN	R/W	0	1: enable the synthesizer calibration state machine. 0: disable the synthesizer calibration state machine.
[0]	RXBB_CAL_EN	R/W	0	1: enable receiver baseband filter (RXBB) calibration. 0: disable receiver baseband filter (RXBB) calibration.

Table 121. 0x339: CALIBRATION\_STATUS

Bit	Name	R/W	Reset	Description
[7:3]	Reserved	R	0	
[2]	PA_RAMP_FINISHED	R	0	
[1]	SYNTH_CAL_READY	R	0	1: synthesizer calibration finished successfully. 0: synthesizer calibration in progress.
[0]	RXBB_CAL_READY	R	0	Receive IF filter calibration. 1: complete. 0: in progress (valid while RXBB_CAL_EN = 1).



Table 122. 0x345: RXBB\_CAL\_CALWRD\_READBACK

Bit	Name	R/W	Reset	Description
[5:0]	RXBB_CAL_CALWRD	R	0	RXBB reference oscillator calibration word; valid after RXBB calibration cycle has been completed.

Table 123. 0x346: RXBB\_CAL\_CALWRD\_OVERWRITE

Bit	Name	R/W	Reset	Description
[6:1]	RXBB_CAL_DCALWRD_OVWRT_IN	RW	0	RXBB reference oscillator calibration overwrite word
[0]	RXBB_CAL_DCALWRD_OVWRT_EN	RW	0	1: enable RXBB reference oscillator calibration word overwrite mode 0: disable RXBB reference oscillator calibration word overwrite mode

Table 124. 0x34F: RCOSC\_CAL\_READBACK\_HIGH

Bit	Name	R/W	Reset	Description
[7:0]	RCOSC_CAL_READBACK[15:8]	R	0x0	Fine RC oscillator calibration result, Bits[15:8]

Table 125. 0x350: RCOSC\_CAL\_READBACK\_LOW

Bit	Name	R/W	Reset	Description
[7:0]	RCOSC_CAL_READBACK[7:0]	R	0x0	Fine RC oscillator calibration result, Bits[7:0]

Table 126. 0x359: ADC\_CONFIG\_LOW

Bit	Name	R/W	Reset	Description
[7:4]	Reserved	R/W	0	Set to 0.
[3:2]	ADC_REF_CHSEL	R/W	0	0: RSSI (default). 1: external AIN 2: temperature sensor 3: unused
[1:0]	ADC_REFERENCE_CONTROL	R/W	0	The following reference values are valid for a 3 V supply: 0: 1.85 V (default) 1: 1.95 V 2: 1.75 V 3: 1.65 V

Table 127. 0x35A: ADC\_CONFIG\_HIGH

Bit	Name	R/W	Reset	Description
[7]	Reserved	R/W	0	
[6:5]	FILTERED_ADC_MODE	R/W	0	Filtering modes. 00: normal operation (no filter). 01: unfiltered AGC loop, filtered readback (updated upon MCR read). 10: unfiltered AGC loop, filtered readback (update at AGC clock rate). 11: filtered AGC loop, filtered readback.
[4]	ADC_EXT_REF_ENB	R/W	1	Bring low to power down the ADC reference.
[3:0]	Reserved	R/W	1	Set to 1.

Table 128. 0x35B: AGC\_OOK\_CONTROL

Bit	Name	R/W	Reset	Description
[5:3]	OOK_AGC_CLK_TRK	R/W	2	AGC update rate during tracking phase $AGC\ Update\ Rate = \frac{F_{MAN}}{2^{(OOK\_AGE\_CLK\_TRK + 1)}}$ where $F_{MAN}$ = the Manchester symbol rate. Manchester encoding is recommended for OOK; OOK_AGC_CLK_TRK must be $\geq$ OOK_AGC_CLK_ACQ.

Bit	Name	R/W	Reset	Description
[2:0]	OOK_AGC_CLK_ACQ	R/W	1	AGC update rate during acquisition phase.  $AGC\ Update\ Rate = \frac{F_{MAN}}{2^{(OOK\_AGE\_CLK\_ACQ + 1)}}$ where $F_{MAN}$ = the Manchester symbol rate. Manchester encoding is recommended for OOK; OOK_AGC_CLK_TRK must be $\geq$ OOK_AGC_CLK_ACQ.

Table 129. 0x35C: AGC\_CONFIG

Bit	Name	R/W	Reset	Description
[7:6]	LNA_GAIN_CHANGE_ORDER	R/W	2	LNA gain change order
[5:4]	MIXER_GAIN_CHANGE_ORDER	R/W	1	Mixer gain change order
[3:2]	FILTER_GAIN_CHANGE_ORDER	R/W	3	Filter gain change order
[1]	ALLOW_EXTRA_LO_LNA_GAIN	R/W	0	Allow extra low LNA gain setting
[0]	DISALLOW_MAX_GAIN	R/W	0	Disallow maximum AGC gain setting

Table 130. 0x35D: AGC\_MODE

Bit	Name	R/W	Reset	Description
[7]	Reserved	R/W	0	
[6:5]	AGC_OPERATION_MCR	R/W	0	0: free-running AGC 1: manual AGC 2: hold AGC 3: lock AGC after preamble
[4:3]	LNA_GAIN	R/W	0	0: low 1: medium 2: high 3: reserved
[2]	MIXER_GAIN	R/W	0	0: low 1: high
[1:0]	FILTER_GAIN	R/W	0	0: low 1: medium 2: high 3: reserved

Table 131. 0x35E: AGC\_LOW\_THRESHOLD

Bit	Name	R/W	Reset	Description
[7:0]	AGC_LOW_THRESHOLD	R/W	55	AGC low threshold

Table 132. 0x35F: AGC\_HIGH\_THRESHOLD

Bit	Name	R/W	Reset	Description
[7:0]	AGC_HIGH_THRESHOLD	R/W	105	AGC high threshold

Table 133. 0x360: AGC\_GAIN\_STATUS

Bit	Name	R/W	Reset	Description
[7:5]	Reserved	R	0	
[4:3]	LNA_GAIN_READBACK	R	0	0: low 1: medium 2: high 3: reserved
[2]	MIXER_GAIN_READBACK	R	0	0: low 1: high
[1:0]	FILTER_GAIN_READBACK	R	0	0: low 1: medium 2: high 3: reserved

Table 134. 0x361: AGC\_ADC\_WORD

Bit	Name	R/W	Reset	Description
[7]	Reserved	R	0	Reserved.
[6:0]	AGC_ADC_WORD	R	0	Auxiliary ADC sample word used when calculating RSSI of OOK signals. See the RSSI Method 4 section for more information.

Table 135. 0x372: FREQUENCY\_ERROR\_READBACK

Bit	Name	R/W	Reset	Description
[7:0]	FREQUENCY_ERROR_READBACK	R	0	Frequency error between received signal frequency and receive channel frequency = FREQUENCY_ERROR_READBACK × 1 kHz. The FREQUENCY_ERROR_READBACK value is in twos complement format.

Table 136. 0x3CB: VCO\_BAND\_OVRW\_VAL

Bit	Name	R/W	Reset	Description
[7:0]	VCO_BAND_OVRW_VAL	R/W	0	Overwrite value for the VCO frequency band; active when VCO_BAND_OVRW_EN = 1.

Table 137. 0x3CC: VCO\_AMPL\_OVRW\_VAL

Bit	Name	R/W	Reset	Description
[7:0]	VCO_AMPL_OVRW_VAL	R/W	0	Overwrite value for the VCO bias current DAC; active when VCO_AMPL_OVRW_EN = 1.

Table 138. 0x3CD: VCO\_OVRW\_EN

Bit	Name	R/W	Reset	Description
[7:6]	Reserved	R/W	0	Reserved.
[5:2]	VCO_Q_AMP_REF	R/W	0	VCO amplitude level control reference DAC during Q phase.
[1]	VCO_AMPL_OVRW_EN	R/W	0	1: enable VCO bias current DAC overwrite. 0: disable VCO bias current DAC overwrite.
[0]	VCO_BAND_OVRW_EN	R/W	0	1: enable VCO frequency band overwrite. 0: disable VCO frequency band overwrite.

Table 139. 0x3D0: VCO\_CAL\_CFG

Bit	Name	R/W	Reset	Description
[7:4]	Reserved	R/W	0	Reserved.
[3:0]	VCO_CAL_CFG	R/W	1	VCO calibration state machine configuration. Set VCO_CAL_CFG = 0xF to bypass VCO calibration on the PHY_TX and PHY_RX transitions. Set VCO_CAL_CFG = 0x1 to enable the VCO calibrations on the transitions.

Table 140. 0x3D2: OSC\_CONFIG

Bit	Name	R/W	Reset	Description
[7:6]	Reserved	R/W	0	Write 0.
[5:3]	XOSC_CAP_DAC	R/W	0	26 MHz crystal oscillator (XOSC26N) tuning capacitor control word.
[2:0]	Reserved	R/W	0	Write 0.

Table 141. 0x3DA: VCO\_BAND\_READBACK

Bit	Name	R/W	Reset	Description
[7:0]	VCO_BAND_READBACK	R	0	Readback of the VCO bias current DAC after calibration

Table 142. 0x3DB: VCO\_AMPL\_READBACK

Bit	Name	R/W	Reset	Description
[7:0]	VCO_AMPL_READBACK	R	0	Readback of the VCO bias current DAC after calibration

Table 143. 0x3F8: ANALOG\_TEST\_BUS

Bit	Name	R/W	Reset	Description
[7:0]	ANALOG_TEST_BUS	R/W	0	To enable analog RSSI on ATB3, set ANALOG_TEST_BUS = 0x64 in conjunction with setting RSSI_TSTMUX_SEL = 0x3.

Table 144. 0x3F9: RSSI\_TSTMUX\_SEL

Bit	Name	R/W	Reset	Description
[7]	Reserved	R/W	0	
[6:2]	Reserved	R/W	0	
[1:0]	RSSI_TSTMUX_SEL	R/W	0	To enable analog RSSI on ATB3, set RSSI_TSTMUX_SEL = 0x3 in conjunction with setting ANALOG_TEST_BUS = 0x64.

Table 145. 0x3FA: GPIO\_CONFIGURE

Bit	Name	R/W	Reset	Description
[7:0]	GPIO_CONFIGURE	R/W	0	0x00: default 0x21: slicer output on GP5 (that is, bypass CDR) 0x40: limiter outputs on GP0(Q) and GP1(I) 0x41: filtered limiter outputs on GP0(Q) and GP1(I) and unfiltered limiter outputs on GP2(Q) and IRQ_GP3 (I) 0x50: packet transmit data from communications processor on GP0 0x53: PA ramp finished on GP0 0xA0: Sport Mode 0 0xA1: Sport Mode 1 0xA2: Sport Mode 2 0xA3: Sport Mode 3 0xA4: Sport Mode 4 0xA5: Sport Mode 5 0xA6: Sport Mode 6 0xA7: Sport Mode 7 0xA8: Sport Mode 8 0xC9: Test DAC output on GP0 (also must set TEST_DAC_GAIN)

Table 146. 0x3FD: TEST\_DAC\_GAIN

Bit	Name	R/W	Reset	Description
[7:4]	Reserved	R/W	0	Reserved.
[3:0]	TEST_DAC_GAIN	R/W	4	Set TEST_DAC_GAIN = 0 when using the test DAC.

# OUTLINE DIMENSIONS

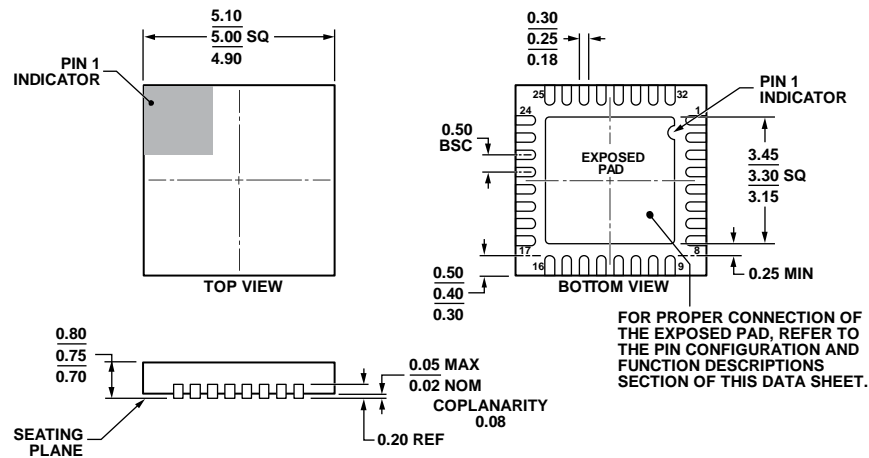

COMPLIANT TO JEDEC STANDARDS MO-220-WHHD.

Figure 117. 32-Lead Lead Frame Chip Scale Package [LFCSP\_WQ]  
 5 mm × 5 mm Body, Very Very Thin Quad  
 (CP-32-13)

Dimensions shown in millimeters

033009-A

## ORDERING GUIDE

Model <sup>1</sup>	Temperature Range	Package Description	Package Option
ADF7023BCPZ	-40°C to +85°C	32-Lead Lead Frame Chip Scale Package [LFCSP_WQ]	CP-32-13
ADF7023BCPZ-RL	-40°C to +85°C	32-Lead Lead Frame Chip Scale Package [LFCSP_WQ]	CP-32-13
EVAL-ADF7XXMB3Z		Evaluation Board (USB Motherboard)	
EVAL-ADF7023DB1Z		Evaluation Board (RF Daughterboard, 868 MHz/915 MHz, Separate Match)	
EVAL-ADF7023DB2Z		Evaluation Board (RF Daughterboard, 868 MHz/915 MHz, Combined Match)	
EVAL-ADF7023DB3Z		Evaluation Board (RF Daughterboard, 433 MHz, Separate Match)	
EVAL-ADF7023DB4Z		Evaluation Board (RF Daughterboard, 433 MHz, Combined Match)	

<sup>1</sup> Z = RoHS Compliant Part.

**ADF7023**

**NOTES**

**NOTES**

**ADF7023**

**NOTES**



Компания «Океан Электроники» предлагает заключение долгосрочных отношений при поставках импортных электронных компонентов на взаимовыгодных условиях!

Наши преимущества:

- Поставка оригинальных импортных электронных компонентов напрямую с производств Америки, Европы и Азии, а так же с крупнейших складов мира;
- Широкая линейка поставок активных и пассивных импортных электронных компонентов (более 30 млн. наименований);
- Поставка сложных, дефицитных, либо снятых с производства позиций;
- Оперативные сроки поставки под заказ (от 5 рабочих дней);
- Экспресс доставка в любую точку России;
- Помощь Конструкторского Отдела и консультации квалифицированных инженеров;
- Техническая поддержка проекта, помощь в подборе аналогов, поставка прототипов;
- Поставка электронных компонентов под контролем ВП;
- Система менеджмента качества сертифицирована по Международному стандарту ISO 9001;
- При необходимости вся продукция военного и аэрокосмического назначения проходит испытания и сертификацию в лаборатории (по согласованию с заказчиком);
- Поставка специализированных компонентов военного и аэрокосмического уровня качества (Xilinx, Altera, Analog Devices, Intersil, Interpoint, Microsemi, Actel, Aeroflex, Peregrine, VPT, Syfer, Eurofarad, Texas Instruments, MS Kennedy, Miteq, Cobham, E2V, MA-COM, Hittite, Mini-Circuits, General Dynamics и др.);

Компания «Океан Электроники» является официальным дистрибьютором и эксклюзивным представителем в России одного из крупнейших производителей разъемов военного и аэрокосмического назначения «JONHON», а так же официальным дистрибьютором и эксклюзивным представителем в России производителя высокотехнологичных и надежных решений для передачи СВЧ сигналов «FORSTAR».



## JONHON

«JONHON» (основан в 1970 г.)

Разъемы специального, военного и аэрокосмического назначения:

(Применяются в военной, авиационной, аэрокосмической, морской, железнодорожной, горно- и нефтедобывающей отраслях промышленности)

«FORSTAR» (основан в 1998 г.)

ВЧ соединители, коаксиальные кабели, кабельные сборки и микроволновые компоненты:

(Применяются в телекоммуникациях гражданского и специального назначения, в средствах связи, РЛС, а так же военной, авиационной и аэрокосмической отраслях промышленности).



Телефон: 8 (812) 309-75-97 (многоканальный)

Факс: 8 (812) 320-03-32

Электронная почта: [ocean@oceanchips.ru](mailto:ocean@oceanchips.ru)

Web: <http://oceanchips.ru/>

Адрес: 198099, г. Санкт-Петербург, ул. Калинина, д. 2, корп. 4, лит. А