

## Features of Intelligent Flag/Intelligent Flag II

### Upgrade Production Lines with Surprising Ease

1. Easy to Use Like a Sensor

Simply operate the Amplifier switches to select the mode and to set transmission settings. Programming is not necessary as was the case with conventional ID models.

2. No Need to be Concerned About Mechanical Troubles or Component Life

Flag codes can be overwritten through wireless transmission, which is unique to the ID System. No need to be concerned about mechanical troubles or component life because there are no mechanical parts like cylinders which are provided for older mechanical flags.

3. Precise Installation Not Required

With the long transmission distance of 65 mm max., accurate positioning as required for older sensors is not necessary. Furthermore, there is no need to be concerned about mutual interference during installation.

4. Minimal Investment for High-level Line Construction

Previously, it was necessary to make as many mechanical flags as the number of models (for example: 256 flags for 256 models). With the Intelligent Flags, however, one Data Carrier can distinguish 256 types.

Type	Flags	Sensors
Mechanical Flags	256 pieces	8 pieces
Intelligent Flags	1 piece	1 piece

5. Saves Space

A single R/W Head of the Intelligent Flag is equivalent to eight sensors and that of the Intelligent Flag II is equivalent to sixteen sensors. Accordingly, the space required for flags is largely reduced due to the use of a single Data Carrier.

6. Wide Variation

The optimum Data Carrier can be selected out of the V600-series Data Carriers depending on the application. Besides which, the Intelligent Flag can be connected to an existing line where V600-series Data Carriers can be used.

7. Provided with a Verification Function

The Intelligent Flag is provided with a verification function that is designed to collate the data read from the Data Carrier with the preset data. With this function, the Intelligent Flag can be easily used for various applications such as automatic line switching or an ID room access control system.

8. Communications Control with Only an Input Unit, Such as One From a Programmable Controller

The Intelligent Flag II saves wiring effort and makes it possible with a 16-point Input Unit, such as one from a Programmable Controller, to perform the communications control of the Intelligent Flag II.

9. Highly Reliable Data Communications

Highly reliable data communications are ensured with the parity-check output of the Intelligent Flag II, which includes parity-check results of 16-bit data to easily check for the disconnection and incorrect connection of the communications line and noise interference during communications.

## Technical Guide

### Intelligent Flag II Has More Advanced Functions

#### ■ Output Used Like Sensor Output

The conventional Intelligent Flag reads data from the Data Carrier and outputs the data for a time that can be set to 10 ms, 50 ms, or continuous, the period of which may be less than the period the Data Carrier is within the transmission area. The Intelligent Flag II reads data from the Data Carrier and outputs the data for the whole period the Data Carrier is within the transmission area plus the output OFF-delay time that can be set to 10 ms, 50 ms, or 500 ms.

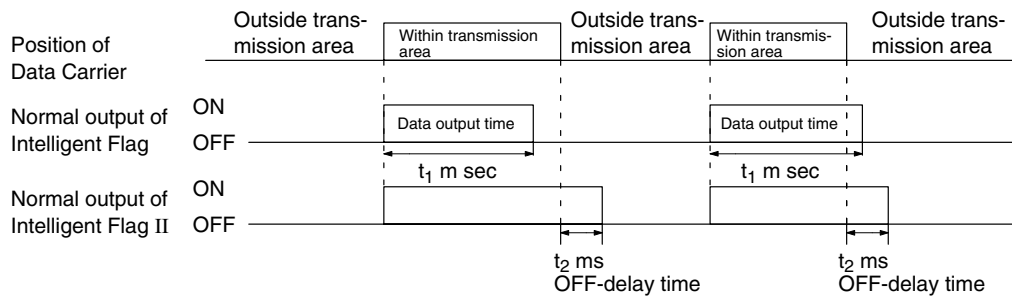

#### ■ Wiring Saving Mode

The Intelligent Flag II has 19 output lines, which are an error output line, strobe output line, parity-check output line, and 16 data output lines, and also has two output modes. The Intelligent Flag II in mode 2 saves wiring man-hours and makes it possible for a single Input Unit, such as one from a Programmable Controller, to perform the 16-bit communications control of the Intelligent Flag II unless all 16 bits are set to 0 or 1.

#### ■ Parity-check Output

The parity-check output line of the Intelligent Flag II makes it possible to easily check for the disconnection and incorrect connection of the line between the Intelligent Flag II and Input Unit and noise interference during communications.

The parity-check output of the Intelligent Flag II will be OFF if the number of its data output lines turned ON is even and ON if the number of its data output lines turned ON is odd.

The construction of an advanced line and system is possible with the Intelligent Flag or Intelligent Flag II at a minimal cost. The following are typical application examples, each in which the Intelligent Flag or Intelligent Flag II is used.

## 8-bit Intelligent Flag Ideal for a Wide Variety of Applications

### Product Distinction

The system is designed to distinguish different products by reading their codes. With the V600-HAR91, the read data is output in parallel for easy distinction. The V600-HAM91 allows the data to be overwritten freely and can easily cope with changes in product types. When used in combination with the Programmable Controller and a display, the system facilitates on-site line distribution or status confirmation.

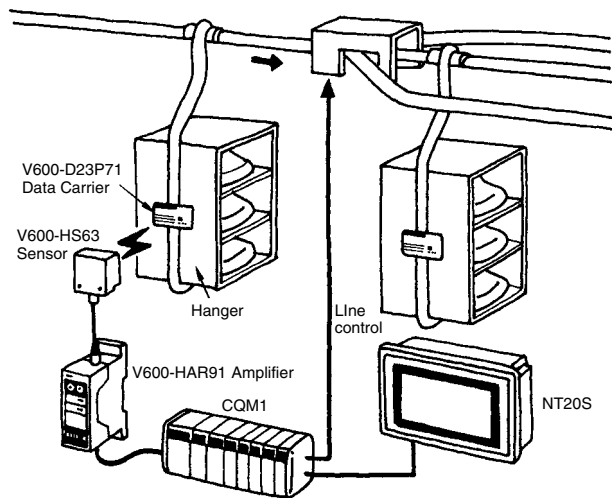

### Room Access Control

It is costly and takes up much space to provide a personal computer control system that unlocks the door only for those with a special registered code. room access control can be realized more easily and at a lower cost by forming a system in which the V600-HAM91 is connected to a compact Programmable Controller or sensor controller. The verification function, if used in the system, will allow easy distinction between the preset code registered on the door side and the code registered on the Data Carrier carried by the DC holders, resulting in a more simplified system configuration.

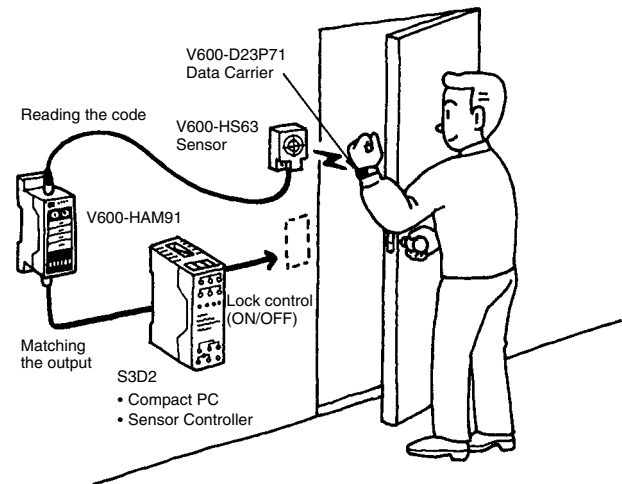

### Production Process Control

The system is designed to read product codes and Process Completion Flags from the Data Carrier in order to check each process and perform the designated tasks. When the tasks in the process are completed, the Process Completion Flag is turned ON (writing "1"). The V600-HAM91 allows overwriting of each bit with an independent meaning assigned to each one of the 8 bits.

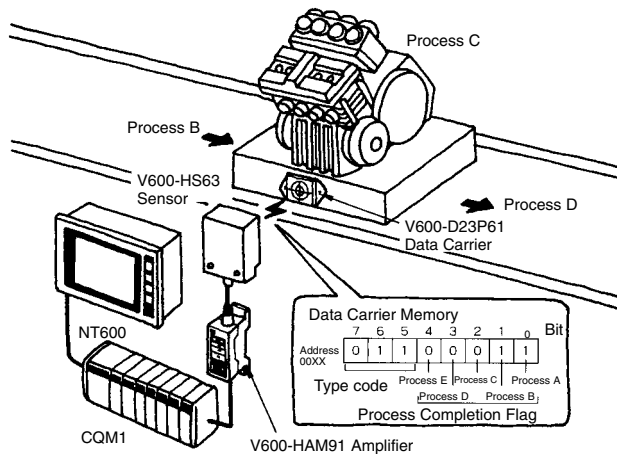

## 16-bit Intelligent Flag

### Product Distinction with Electronic Kanban

The V600-HAR92 reads each product code to display it in alphanumeric characters within four characters on the Display Unit as an electronic Kanban, thus reducing the number of paper sheets used for production process control and careless mistakes.

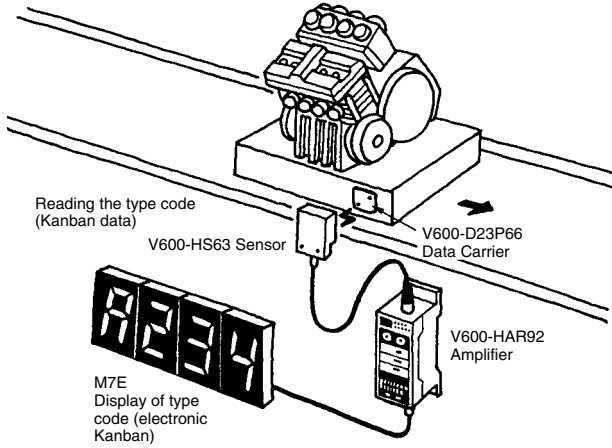

### Product Quality Control for Conforming to ISO and GMP Requirements and in Consideration of Product Liability

The V600-HAR92 handles the product codes, product inspection data, and production process data of a variety of products, thus making it possible to manufacture the products efficiently while referring to the product inspection data and ensuring improvements in product quality control.

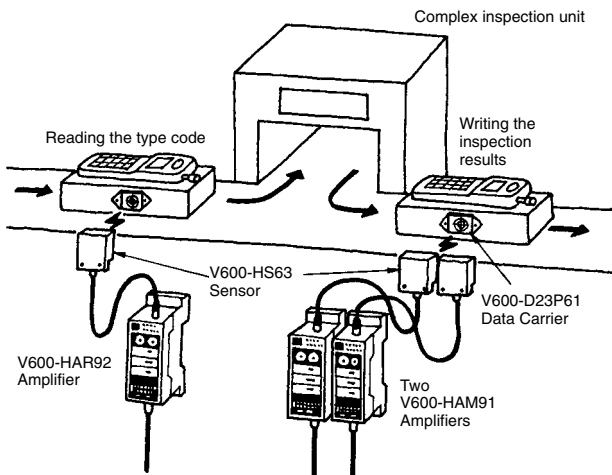

### Distinction of Different Products

The V600-HAR92 in mode 2 saves wiring effort and makes it possible for a 16-point Input Unit to perform the 16-input communications control of the V600-HAR92 via a Unit saving wiring, and is ideal for the distinction of the different products on a belt conveyor line.

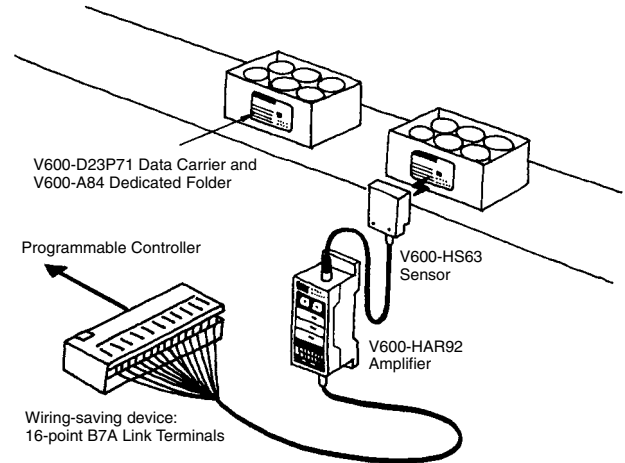

## 16-bit Intelligent Flag II and 8-bit Intelligent Flag are Ideal for a Greater Variety of Applications

### Products and Main Functions

#### ■ Products

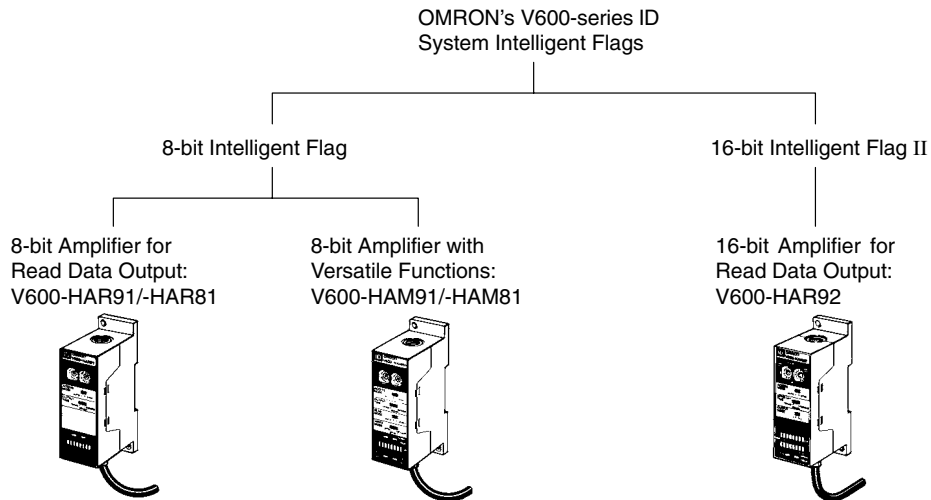

#### ■ Main Functions

Functions		V600-HAR91/-HAR81	V600-HAM91/-HAM81	V600-HAR92
Data reading	8 bits	Yes	Yes	(Yes)
	16 bits			Yes
Data writing	8 bits (1 byte), block		Yes	
	1 bit (ON or OFF), independent		Yes	
Verification of read data with set data			Yes	
Parity-check code output				Yes
Wiring saving mode				Yes

#### Ideal Combinations

The construction of an advanced line and system is possible with the Intelligent Flag or Intelligent Flag II at a minimal cost. The following lists the Intelligent Flag or Intelligent Flag II that will operate the most efficiently for a given application.

**List of Application Examples**

Application	Data		Process	Model				Page
				V600-HAR91/-HAR81	V600-HAM91/-HAM81	V600-HAR92	General-purpose ID system	
Product distinction	256 types/8 bits max.		Writing of product data		Yes		(Yes)*	11
			Reading of product data	Yes				
	257 types/9 bits min.		Writing of product data		(Yes) Two Units		Yes	
			Reading of product data			Yes		
Kanban	Alphanumeric characters 3 to 4 digits (12 to 16 bits)		Writing of Kanban data				Yes	12
			Reading of Kanban data			Yes		
Product distinction and production process control	A total of 8 bits max. Example: Distinction of 16 types of products/4 bits max. Production process control of 4 processes/4 bits max.		Writing of product data and resetting of production process control data		Yes		(Yes)*	14
			Reading of product data	Yes	(Yes)			
			Writing of production Process Completion Flag		Yes			
			Reading of all data (product data and production process control data)	Yes				
Product distinction and production process control	A total of 16 bits max.	Example: Distinction of 256 types of products/ 8 bits max. Production process control of 8 processes/ 8 bits max.	Writing of product data write and resetting of production process control data		Yes		(Yes)*	15
			Reading of product data	Yes				
			Writing of production Process Completion Flag		Yes			
			Reading of all data (product data and production process control data)			Yes		
	Example: Distinction of 128 types of products/ 7 bits max. Production process control of 9 processes/ 9 bits max.	Example: Distinction of 128 types of products/ 7 bits max. Production process control of 9 processes/ 9 bits max.	Writing of product data and resetting of production process control data		Yes		(Yes)*	16
			Reading of product data	Yes				
			Writing of production Process Completion Flag		Yes			
			Reading of all data (product data and production process control data)			Yes		

Application	Data		Process	Model				Page
				V600-HAR91/-HAR81	V600-HAM91/-HAM81	V600-HAR92	General-purpose ID system	
Product distinction and production quality control	A total of 8 bits max. Example: Distinction of 8 types of products/3 bits max. Product quality control of 5 processes/5 bits max.		Writing of product data and resetting of product quality control data		Yes		(Yes)*	17
			Reading of product data	Yes				
			Writing of product quality control data (Accepted or Rejected)		Yes			
			Reading of all data (product data and product quality control data)			Yes		
A total of 16 bits max.	Example: Distinction of 256 types of products/ 8 bits max. Production process control of 8 processes/ 8 bits max.		Writing of product data and resetting of product quality control data		Yes		(Yes)*	18
			Reading of product data	Yes				
			Writing of product quality control data (Accepted or Rejected)		Yes			
			Reading of all data (product data and product quality control data)			Yes		
A total of 9 bits max.	Example: Distinction of 128 types of products/ 7 bits max. Production process control of 9 processes/ 9 bits max.		Writing of product data and resetting product quality control data		Yes		(Yes)*	19
			Reading of product data	Yes				
			Writing of product quality control data (Accepted or Rejected)		Yes			
			Reading of all data (product data and product quality control data)			Yes		

**Note:** \*When other data is written simultaneously.

## Applications of Intelligent Flag or Intelligent Flag II According to the Process

### Product Distinction

**Processes bit data.  
Used as a mechanical flag.**

#### ■ Number of Product Types to Distinguish: 256 or Less

##### Example: 256 Types

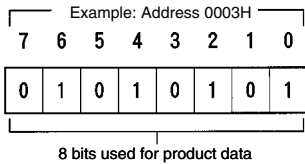

##### Example: 16 Types

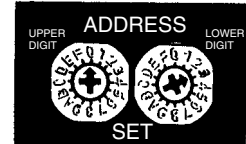
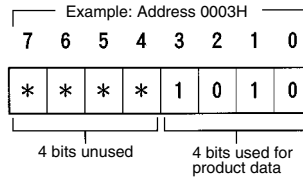

1. To write product data:  
Use the V600-HAM91 and set the address to 0003H.
2. To read product data from each process:  
Use the V600-HAR91. If the address is set to 0003H, 8 bits will be read.

#### ■ Number of Product Types to Distinguish: 257 or More (64,000 max.)

##### Example: 1,024 Types

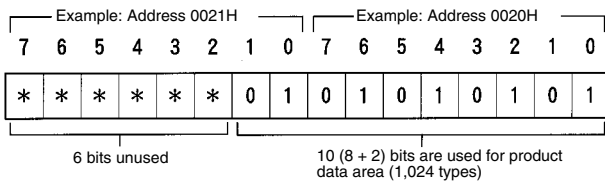

First Unit

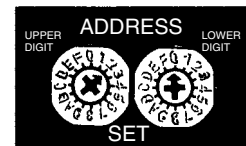

16th Unit

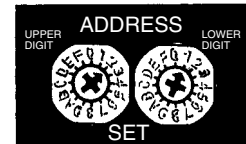

1. To write product data:  
Use the conventional ID System or two V600-HAM91 Units. The address of each Unit must be unique (e.g., set the address of a Unit to 0020H and the address of the other Unit to 0021H).
2. To read product data from each process:  
Use the V600-HAR92. If the address is set to 0020H, the 16 bits of 0020H and 0021H will be read.



## Product Distinction

Processes Kanban data in alphanumeric characters.  
With a maximum of 4 digits (16 bits).

1. To write Kanban data: Use the conventional ID System.  
Example: 000 to 999  
0000 to FFFF

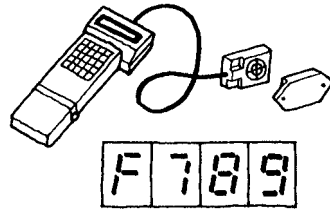
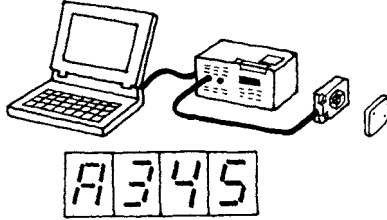

2. To read Kanban data: Use the V600-HAR92 and set the address to 0010H.

To read and convert bit data to alphanumeric characters for display.

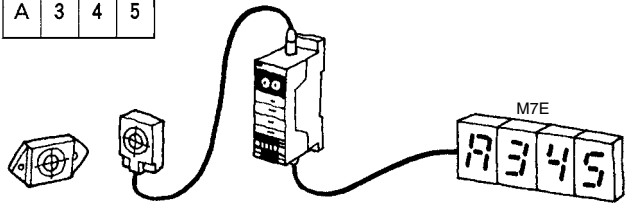
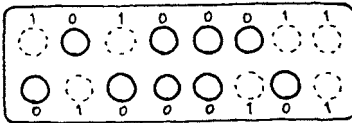
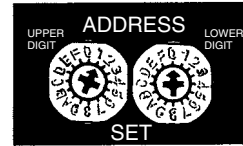
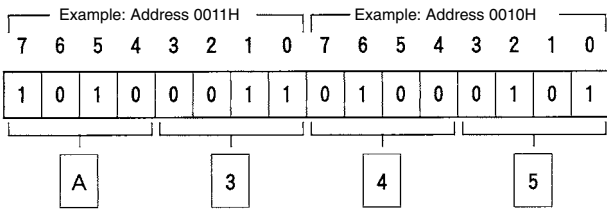

## ■ Utilization of Conventional ID System

The conventional ID System can be used with the Intelligent Flag II. The use of the ID System varies with the proximity system or application.

- Host: Personal computer or Serial Interface Unit with RS-232C or RS-422  
Example: Serial Host Interface ID Controller
- No host  
Example: IDSC-C1D□-A ID Controller

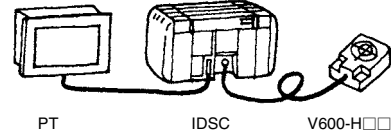
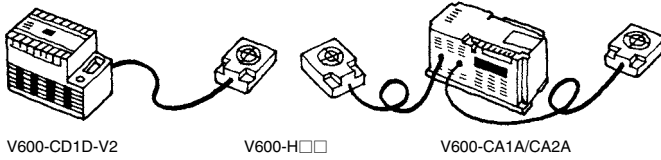

- Host: Programmable Controller  
Example: Dedicated ID Sensor Unit
- On-site Operation with No Host  
Example: Hand-held ID Controller

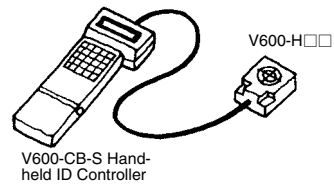
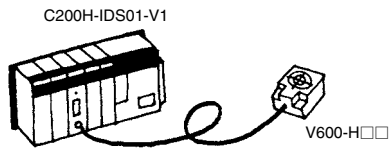

- Example: Parallel Host Interface ID Controller

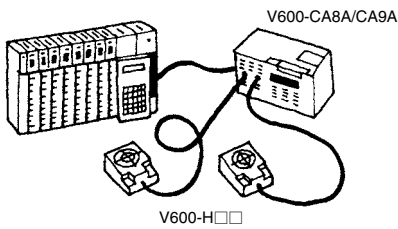

# Production Process Control

**Production process control with bit data and product inspection data.**  
**Used as a mechanical flag to distinguish products and will set a bit to 1**  
**when a process is completed without error.**

## Application 1

### ■ No. of Product Types + No. of Processes: 8 Bits or Less

**Example: 16 Product Types and 4 Processes**

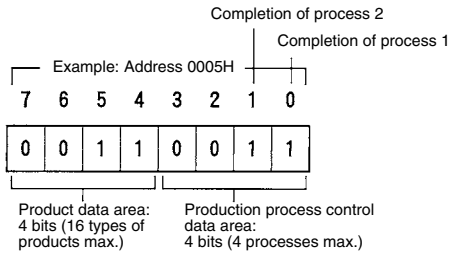

**Example: 4 Product Types and 6 Processes**

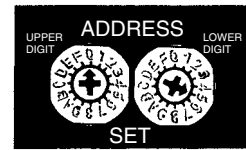
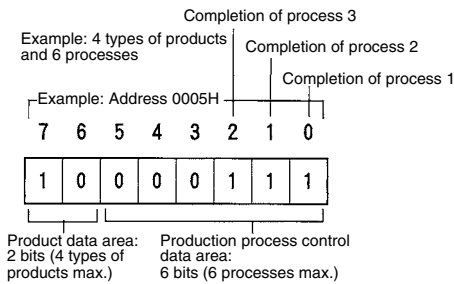

1. To write product data and reset product quality control data (set to 0):  
 Use V600-HAM91 Units and set the address of each Unit to 0005H.
2. To read product data from each process:  
 Use V600-HAR91 Units and set the address of each Unit to 0005H.
3. To read a Process Completion Flag from each completed process:  
 Use V600-HAR91 Units and set the address each Unit to 0005H.  
 A single V600-HAR91 can be used to read product data from each process and a Process Completion Flag from each completed process if they are executed at the same station.
4. To write a Process Completion Flag to each completed process. (A single bit is written by the V600-HAM91 for each process in bit set mode.):  
 Use V600-HAM91 Units and set the address of each Unit to 0005H.  
 A single V600-HAM91 can be used to read a Process Completion Flag from each completed process and write a Process Completion Flag to each completed process if they are executed at the same station.
5. To read all data (product data and product quality control data) at the final process:  
 Use the V600-HAR91 and set the address to 0005H.

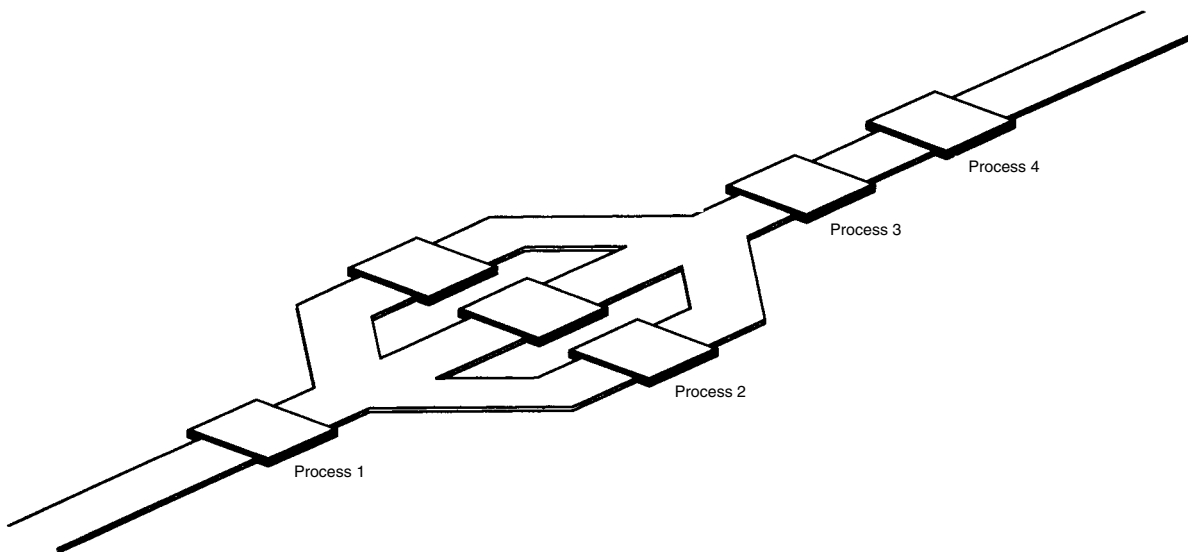

## Application 2

- **No. of Product Types + No. of Processes: Between 8 and 16 Bits**  
**No. of Product Types: 8 Bits (256 Types) or Less and**  
**No. of Processes: 8 Bits (8 Processes) or Less**

**Example: 256 Product Types and 8 Processes**

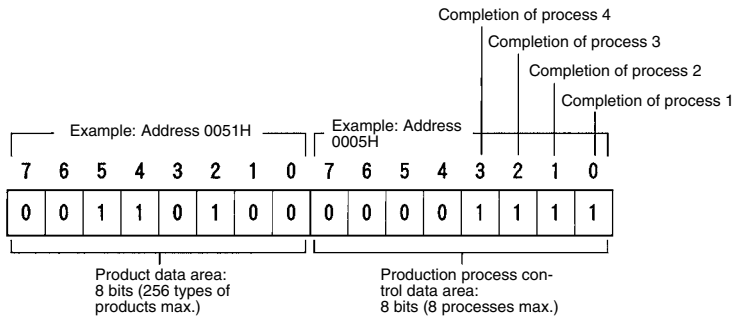

First Unit

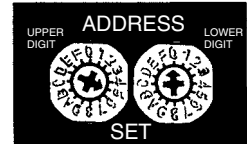

Second Unit

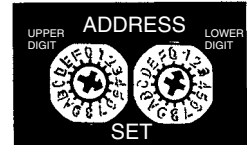

1. To write product data and reset production process control data (set to 0):  
*Use the conventional ID System or two V600-HAM91 Units. The address of each Unit must be unique (e.g., set the address of a Unit to 0050H and the address of the other Unit to 0051H).*
2. To read product data from each process:  
*Use V600-HAR91 Units and set the address of each Unit to 0051H.*
3. To read a Process Completion Flag from each completed process:  
*Use V600-HAR91 Units and set the address each Unit to 0050H.*  
*A single V600-HAR92 can be used to read product data from each process and a Process Completion Flag from each completed process if they are executed at the same station, in which case 0050H will be used.*
4. To write a Process Completion Flag to each completed process. (A single bit is written by the V600-HAM91 for each process in bit set mode.):  
*Use V600-HAM91 Units and set the address of each Unit to 0050H.*  
*A single V600-HAM91 can be used to read a Process Completion Flag from each completed process and write a Process Completion Flag to each completed process if they are executed at the same station, in which case set the address to 0050H.*
5. To read all data (product data and product quality control data) at the final process:  
*A total of 16 bits is read simultaneously.*

## Application 3

- **No. of Product Types + No. of Processes: 16 Bits or Less**  
**No. of Product Types: 7 Bits (128 Types) or Less and**  
**No. of Processes: 9 Bits (9 Processes) or More**

**Example: 8 Product Types and 13 Processes**

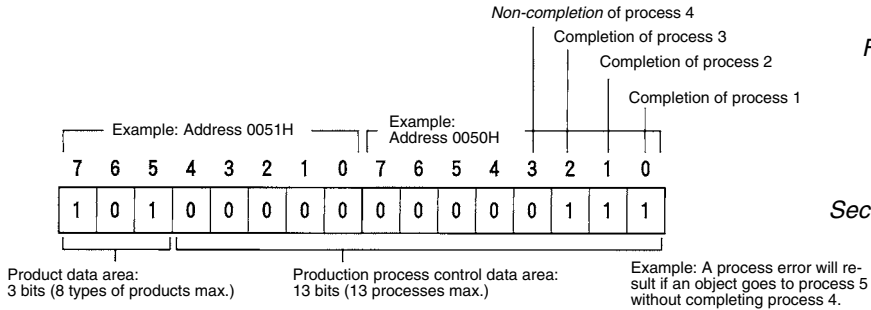

First Unit

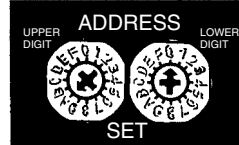

Second Unit



1. To write product data and reset production process control data (set to 0):  
 Use the conventional ID System or two V600-HAM91 Units. The address of each Unit must be unique (e.g., set the address of a Unit to 00A0H and the address of the other Unit to 00A1H).
2. To read product data from each process:  
 Use V600-HAR91 Units and set the address of each Unit to 00A1H.
3. To read a Process Completion Flag from each completed process:  
 Use V600-HAR91 Units and set the address of each Unit for processes 1 to 8 to 00A0H and the address of each Unit for processes 9 to 13 to 00A1H.  
 A single V600-HAR92 can be used to read product data from each process and a Process Completion Flag from each completed process if they are executed at the same station, in which case 00A0H will be used.
4. To write a Process Completion Flag each for all completed process. (A single bit is written by the V600-HAM91 for each process in bit set mode.):  
 Use V600-HAM91 Units and set the address of each Unit for processes 1 to 8 to 00A0H and the address of each Unit for processes 9 to 13 to 00A1H.
5. To read all data (product data and product quality control data) at the final process:  
 A total of 16 bits is read simultaneously.  
 Use V600-HAR92 Units and set the address of each Unit to 00A0H.

**Note:** If Process Completion Flags are written to more than nine processes, set the address of each Unit for the first eight processes to 0010H and the address of each Unit for the succeeding processes to 0011H, for example.

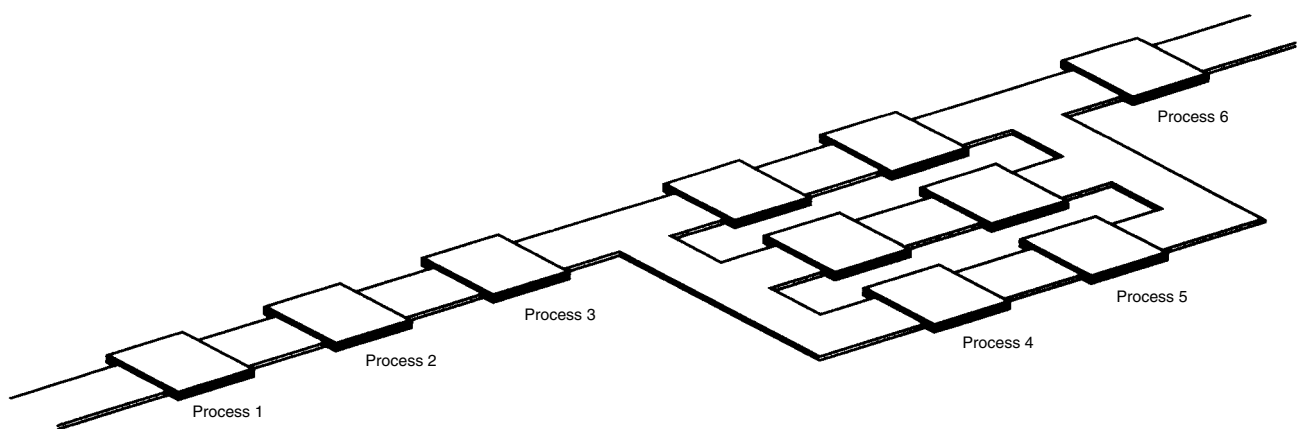

## Product Quality Control

**Product quality control with bit data and product inspection data.**  
 Used as a mechanical flag to distinguish products and will set an Accepted or Rejected Flag when a product inspection is completed.

### Application 1

■ **No. of Product Types + No. of Processes: 8 Bits or Less**

**Example: 8 Product Types and 5 Inspection Processes**

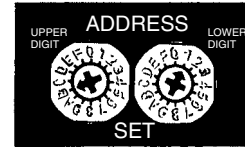
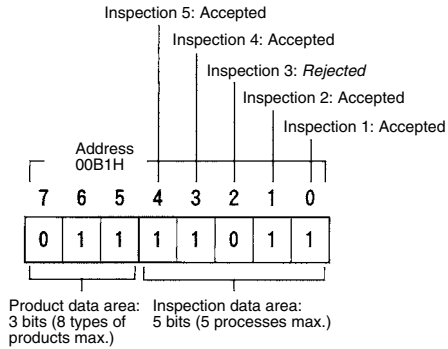

1. To write product data and reset inspection data area (set 0):  
 Use the V600-HAM91 and set the address to 00B1H.
2. To read product data from each inspection process. (An inspection varies with the type of product.):  
 Use V600-HAR91 Units and set the address of each Unit to 00B1H.
3. To read the inspection result from the previous process. (This is effective when a product must not go to the next process until the product finishes an inspection at the previous process.):  
 Use V600-HAR91 Units and set the address of each Unit to 00B1H.  
*A single V600-HAR91 can be used to read product data from each inspection process and the result of inspection from the previous process if they are executed at the same station.*
4. To write the inspection result at each stage (1 for Accepted and 0 for Rejected) (A single bit is written by the V600-HAM91 for each process in bit set mode.):  
 Use V600-HAM91 Units and set the address of each Unit to 00B1H.  
*A single V600-HAM91 can be used to read product data from each inspection process, read the result of inspection from the previous process, and write the result of inspection at each process if they are executed at the same station.*
5. To read all data (product data and product inspection data) at the final process:  
 Use the V600-HAR91 and set the address to 00B1H.

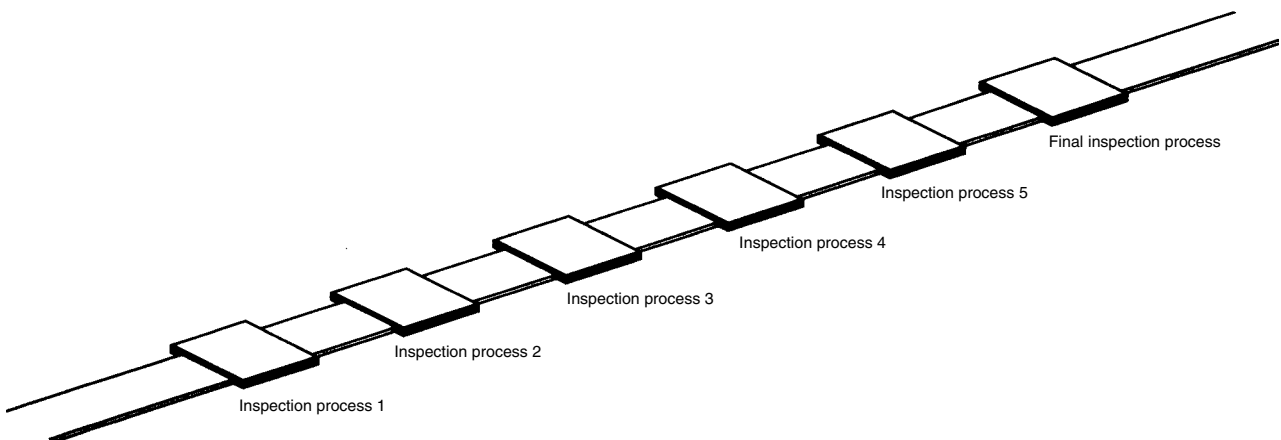

## Application 2

- **No. of Product Types + No. of Processes: 16 Bits or Less**  
**No. of Product Types: 8 Bits (256 Types) or Less and**  
**No. of Processes: 8 Bits (8 Processes) or Less**

**Example: 256 Product Types and 8 Processes**

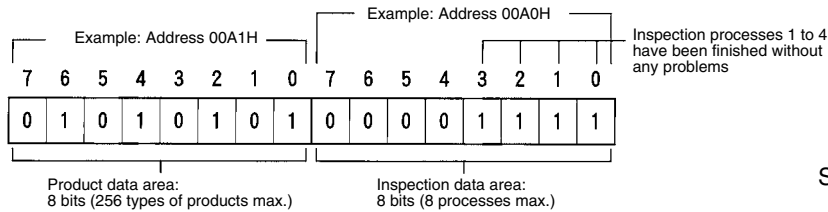

First Unit

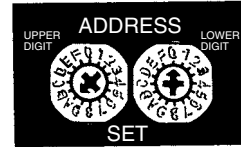

Second Unit

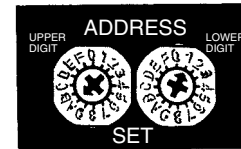

1. To write product data and reset inspection data area (set 0):  
*Use the conventional ID System or two V600-HAM91 Units. The address of each Unit must be unique (e.g., set the address of a Unit to 00A0H and the address of the other Unit to 00A1H).*
2. To read product data from each inspection process. (An inspection varies with the type of product.):  
*Use V600-HAR91 Units and set the address of each Unit to 00A1H.*
3. To read the inspection result from the previous process. (This is effective when a product must not go to the next process until the product finishes an inspection at the previous process.):  
*Use V600-HAR91 Units and set the address of each Unit to 00A1H.*  
*A single V600-HAR92 can be used to read product data from each inspection process and the result of inspection from the previous process if they are executed at the same station, in which case set the address to 00A0H.*
4. To write the inspection result at each stage (1 for Accepted and 0 for Rejected) (A single bit is written by the V600-HAM91 for each process in bit set mode.):  
*Use V600-HAM91 Units and set the address of each Unit to 00A1H.*  
*A single V600-HAM91 can be used to read product data from each inspection process, read the result of inspection from the previous process, and write the result of inspection at each process if they are executed at the same station.*
5. To read all data (product data and product inspection data) at the final process. (A total of 16 bits is read simultaneously.):  
*Use the V600-HAR92 and set the address to 00A0H.*

## Application 3

- No. of Product Types + No. of Processes: 16 Bits or Less**  
**No. of Product Types: 7 Bits (128 Types) or Less and**  
**No. of Processes: 9 Bits (9 Processes) or More**

**Example: 16 Product Types and 12 Processes**

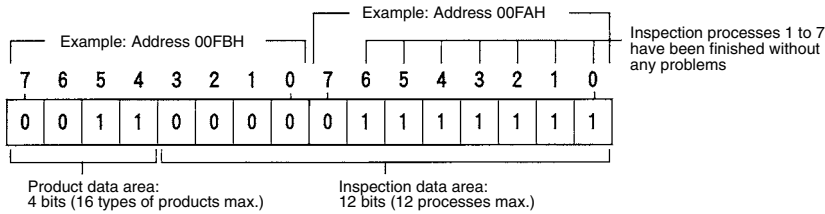

First Unit

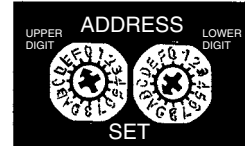

Second Unit

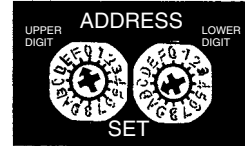

- To write product data and reset inspection data area (set 0):  
Use the conventional ID System or two V600-HAM91 Units. The address of each Unit must be unique (e.g., set the address of a Unit to 00FAH and the address of the other Unit to 00FBH).
- To read product data from each inspection process. (An inspection varies with the type of product.):  
Use V600-HAR91 Units and set the address of each Unit to 00FBH.
- To read the inspection result from the previous process. (This is effective when a product must not go to the next process until the product finishes an inspection at the previous process.):  
Use V600-HAR92 Units and set the address of each Unit for inspection processes 1 to 8 to 00FAH and the address of each Unit for processes 9 to 12 to 00FBH.  
*A single V600-HAR92 can be used to read product data from each inspection process and the result of inspection from the previous process if they are executed at the same station, in which case set the address to 00FAH.*
- To write the inspection result at each inspection process (1 for Accepted and 0 for Rejected) (A single bit is written by the V600-HAM91 for each process in bit set mode.):  
Use V600-HAM91 Units and set the address of each Unit for inspection processes 1 to 8 to 00FAH and the address of each Unit for processes 9 to 12 to 00FBH.
- To read all data (product data and product inspection data) at the final process. (A total of 16 bits is read simultaneously):  
Use the V600-HAR92 and set the address to 00FAH.

**Note:** For example, set the address of each V600-HAM91 Unit for the first eight processes to 00FAH and the address of each V600-HAM91 Unit for the succeeding processes to 00FBH if product inspection data is written to more than nine inspection processes. The V600-HAM91 in bit set mode makes it possible to easily write the result of inspection to one bit only. If the result of inspection is Rejected, the data will be 0 or cleared by the V600-HAM91 in bit clear mode.



# Intelligent Flag I/II V600-HA

An RFID system that is as easy and simple to use as a sensor. No programming required.

- Saves space.
- Transmission distance: 100 mm max.
- A verification function provided on multi-functional type.
- Addition of 16-bit models to the series enables a wide range of applications that include even quality control management.
- Equipped with a wiring reduction mode and communications parity check function (16-bit models).
- Both NPN and PNP output available.
- CE marking/FCC approvals.



**Caution**  
Refer to "Correct Use" on page 27 for details.

## Ordering Information/Specifications

### ■ Amplifier

Item	Type Model	Read-only		Multi-functional		Read-only
		V600-HAR91	V600-HAR81	V600-HAM91	V600-HAM81	V600-HAR92
Power supply	24 VDC ±10%, ripple (p-p): 10%					
Current consumption	130 mA max.					
Input	Transistor output or contact output Short-circuit current: 3 mA (typical) (IN terminal and 0-V short-circuit) OFF voltage: 15 to 30 VDC ON voltage: 0 to 5 VDC Input impedance: 8.2 kΩ Applied voltage: 30 VDC max.					Transistor output OFF voltage: 15 to 30 VDC Input impedance: 8.2 kΩ Short-circuit current: 3 mA (typical) (for 0-V short-circuit of INHIBIT/TRG) ON voltage: 0 to 5 VDC Applied voltage: 30 VDC max.
Output	NPN open collector output, 20 mA max. at 30 VDC, residual voltage: 2 V max.	PNP open collector output, 20 mA max. at 30 VDC, residual voltage: 2 V max.	NPN open collector output, 20 mA max. at 30 VDC, residual voltage: 2 V max.	PNP open collector output, 20 mA max. at 30 VDC, residual voltage: 2 V max.	NPN open collector output, 20 mA max. at 30 VDC, residual voltage: 2 V max.	
Diagnostic functions	Checks for CPU errors and transmission errors					
Insulation resistance	50 MΩ max. (at 500 VDC) between cable terminals and case					
Dielectric strength	500 VAC, 50/60 Hz for 1 min between cable terminals and case (leakage current: 1 mA max.)					

Item	Type Model	Read-only		Multi-functional		Read-only
		V600-HAR91	V600-HAR81	V600-HAM91	V600-HAM81	V600-HAR92
Vibration resistance		Destruction: 10 to 150 Hz, 0.3-mm double amplitude, with 4 sweeps of 8 min each in 3 directions				Destruction: 10 to 150 Hz, 1.5-mm double amplitude, with 4 sweeps of 8 min each in 3 directions
Shock resistance		Destruction: 294 m/s <sup>2</sup> , 3 times each in 6 directions				
Ambient temperature		-10 to 55°C (with no icing)				
Ambient humidity		35% to 85% (with no condensation)				
Storage temperature		-25 to 65°C				
Degree of protection		IEC 60529: IP40				
Ground		Ground to 100 Ω or less.				
Material		ABS resin (case)				
Cable length		Standard, 0.5 m with a dedicated connector (See note.)				
Weight		Approx. 170 g				Approx. 180 g





**Note:** The connector is not watertight. If there is a possibility that the connector may be exposed to water, keep it inside the control box. Be sure to use the connector together with the separately sold interface cable.

### ■ Interface Cable

Amplifier	Cable length	Interface Cable
V600-HAR91/81 (Connector: 20 pin)	2 m	V600-A60R
	5 m	V600-A61R
	10 m	V600-A62R
V600-HAM91/81 V600-HAR92 (Connector: 26 pin)	2 m	V600-A60M
	5 m	V600-A61M
	10 m	V600-A62M

**Note:** The interface cable connector is not watertight. If there is a possibility that the connector may be exposed to water, keep it inside the control box. The maximum cable length is 10 m.

### ■ Sensor

Item	Model Shape	V600-HS51	V600-HS61	V600-HS63	V600-HS67
					
Transmission frequency	530 kHz				
Ambient temperature	-10 to 60°C			-10 to 70°C	
Storage temperature	-25 to 75°C				
Ambient humidity	35% to 95%				
Insulation resistance	50 MΩ (at 500 VDC) between cable terminal and case				
Dielectric strength	1,000 VAC, 50/60 Hz for 1 min between cable terminal and case (leakage current: 1 mA max.)				
Degree of protection	IEC 60529: IP67				
Vibration resistance	Destruction: 10 to 2,000 Hz, 3-mm double amplitude, with 2 sweeps of 15 min each in 3 directions			Destruction: 10 to 500 Hz, 2-mm double amplitude, with 3 sweeps of 11 min each in 3 directions	
Shock resistance	Destruction: 981 m/s <sup>2</sup> , 3 times each in 3 directions (18 times total)			Destruction: 490 m/s <sup>2</sup> , 3 times each in 3 directions (18 times total)	
Cable length	2 m (fixed)				
Wireless transmission error direction	16-bit CRC (Cyclic Redundancy Check) in both directions				
Indicator	---			Power: green	
Weight	Approx. 70 g			Approx. 190 g	Approx. 540 g

# System Configuration

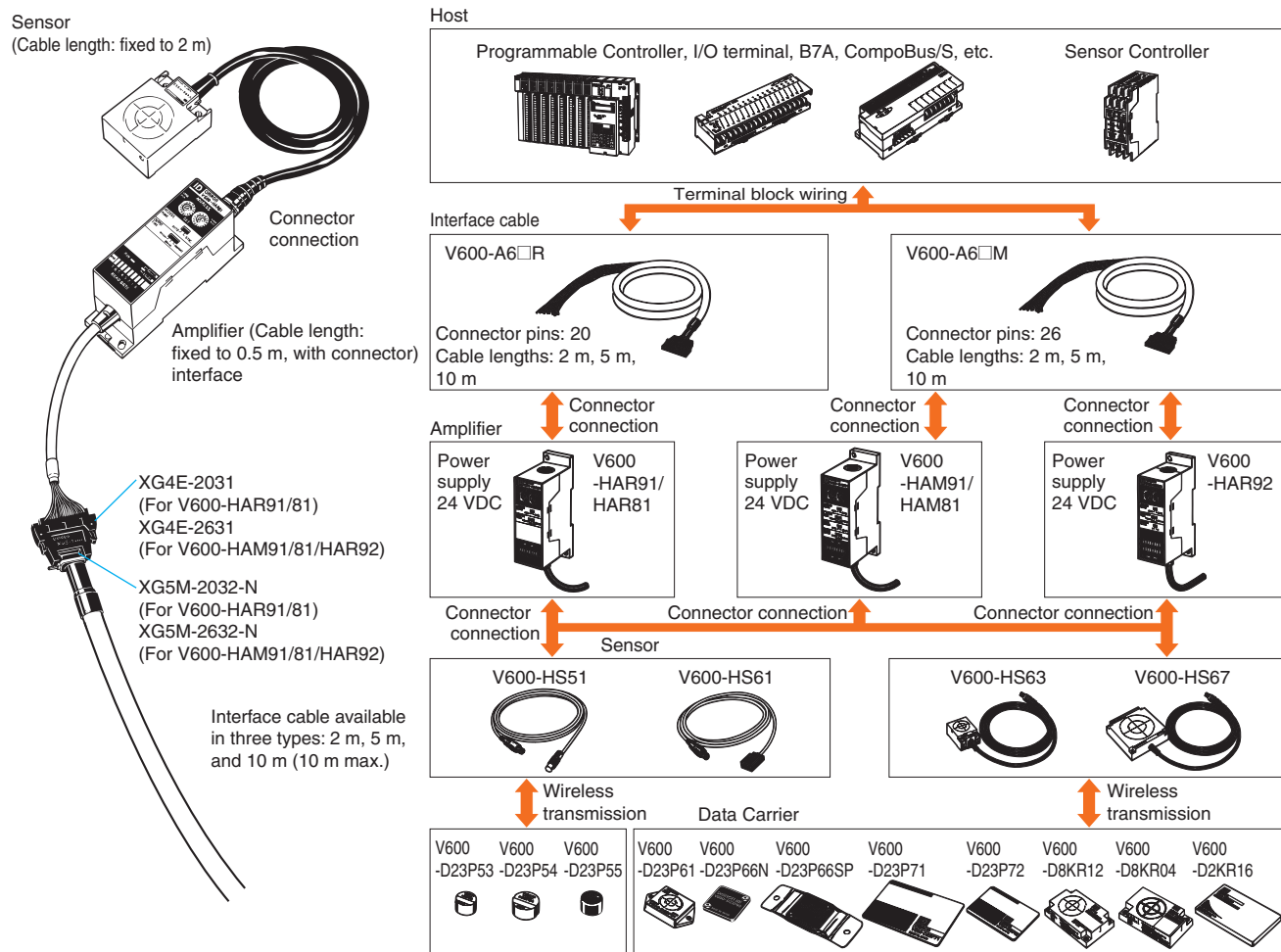

## Functions and Specifications

### ■ Functions

#### V600-HAR91/-HAR81 (Read-only type)

Reads the 8-bit data (1 byte) of the set address and outputs to the 8 data output lines.

#### V600-HAM91/-HAM81 (Multi-functional type)

The amplifier has the following three basic functions.

##### Read

Reads the 8-bit (1 byte) data of the set address and outputs to the 8 data output lines.

##### Write

Writes on the set address the 8-bit (1 byte) data designated via the 8 data input lines.

##### Verify

Reads the 8-bit data (1 byte) of the set address, compares with the 8-bit (1 byte) data input via the 8 verification data input lines, and outputs the verification result.

#### V600-HAR92 (Read-only type)

Reads the 16-bit data (2 bytes) of the set address and outputs to the 16 data output lines.

# Transmission Distance Specifications

## Recommended Combinations

Data Carrier	Amplifier Sensor	V600-HAR91/-HAR81/-HAM91/-HAM81/-HAR92			
		V600-HS51	V600-HS61	V600-HS63	V600-HS67
Memory EEPROM (Battery-less type)	V600-D23P53	0.5 to 3.0 mm	0.5 to 3.0 mm	---	---
	V600-D23P54	0.5 to 5.0 mm	0.5 to 5.5 mm	---	---
	V600-D23P55	0.5 to 7.0 mm	0.5 to 7.0 mm	0.5 to 9.5 mm	---
	V600-D23P61	0.5 to 8.0 mm	0.5 to 9.0 mm	2 to 16 mm	---
	V600-D23P66N	---	---	5 to 30 mm	5 to 35 mm
	V600-D23P66SP	---	---	5 to 25 mm	5 to 30 mm
	V600-D23P71	---	---	5 to 35 mm	10 to 70 mm
	V600-D23P72	---	0.5 to 18 mm	5 to 35 mm	10 to 50 mm
Memory SRAM (Built-in-battery type)	V600-D8KR12	5 to 15 mm	5 to 18 mm	5 to 45 mm	10 to 60 mm
	V600-D8KR13	---	---	10 to 30 mm	10 to 40 mm
	V600-D8KR04	---	---	10 to 65 mm	10 to 100 mm
	V600-D2KR16	---	---	2 to 15 mm	---

- Note:**
- The specifications take fluctuations in ambient temperature and slight differences between products into account.
  - The read distance and write distance are the same.
  - Sensor Installation Conditions
    - V600-HS51: When flush-mounted in iron  
Axial offset from the Data Carrier:  $\pm 2.0$  mm
    - V600-HS61: When surface-mounted on metal (ferrous)  
Axial offset from the Data Carrier:  $\pm 2.0$  mm
    - V600-HS63: When surface-mounted on metal (ferrous)  
Axial offset from the Data Carrier:  $\pm 10.0$  mm
    - V600-HS67: When surface-mounted on metal (ferrous)  
Axial offset from the Data Carrier:  $\pm 10.0$  mm
  - Data Carrier Installation Conditions
    - V600-D23P53/-P54: When flush-mounted in iron
    - V600-D23P55/-P66N/-P66SP/-P71/-P72: When surface-mounted on resin (no metal on the backside)
    - V600-D23P61: When surface-mounted on metal (ferrous)
    - V600-D8KR12/-13/-04: When surface-mounted on metal (ferrous)
    - V600-D2KR16: When the Data Carrier attached to the holder is mounted on a metal (ferrous) surface
  - The transmission distance specified in the specifications is also applicable when the Data Carrier is mounted on non-metallic surfaces.
  - The Data Carrier is stationary.

## Circuit Configuration

### V600-HAR91 V600-HAM91

#### Input Circuit

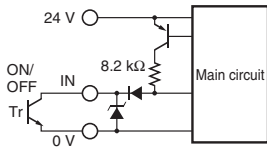

#### Output Circuit

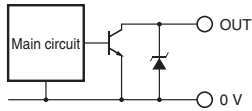

### V600-HAR92

#### Input Circuit

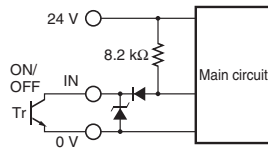

#### Output Circuit

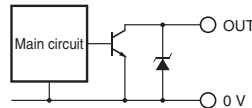

### V600-HAR81 V600-HAM81

#### Input Circuit

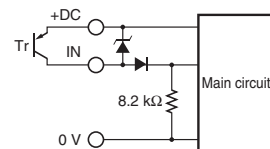

#### Output Circuit

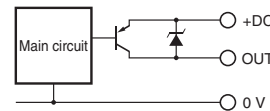

# Characteristic Data (Typical)

## ■ Transmission Range

### Combinations with the V600-HS51 Sensor

V600-HS51 & V600-D23P53

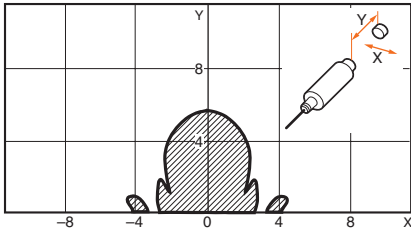

V600-HS51 & V600-D23P54

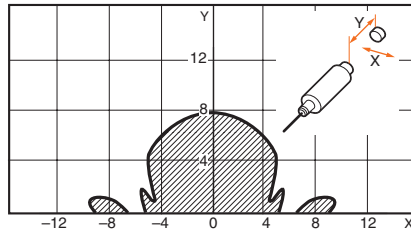

V600-HS51 & V600-D23P55

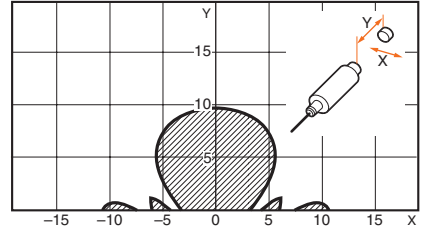

V600-HS51 & V600-D23P61

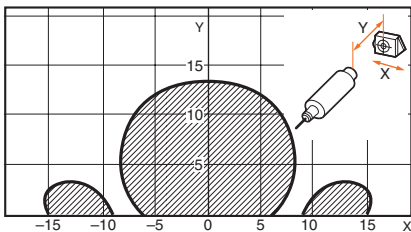

V600-HS51 & V600-D8KR12

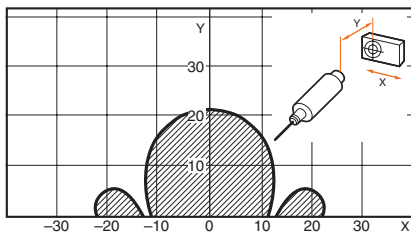

### Combinations with the V600-HS61 Sensor

V600-HS61 & V600-D23P53

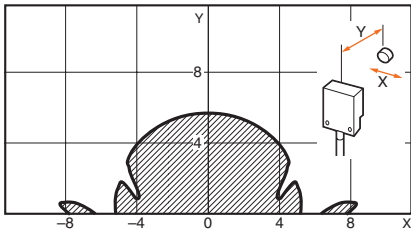

V600-HS61 & V600-D23P54

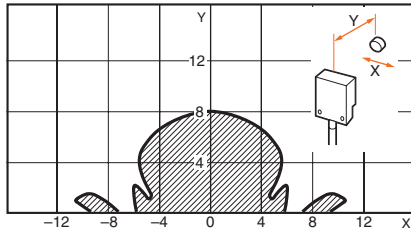

V600-HS61 & V600-D23P55

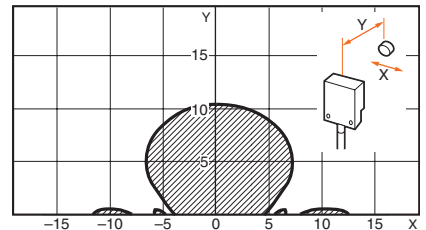

V600-HS61 & V600-D23P61

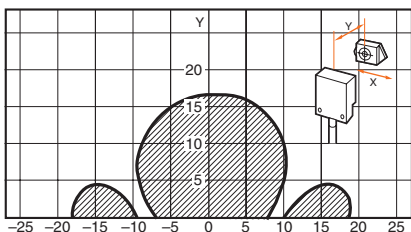

V600-HS61 & V600-D23P72

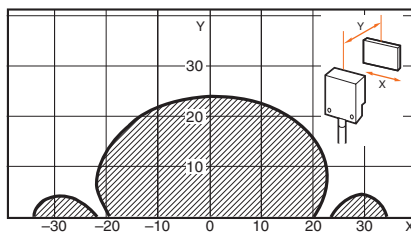

V600-HS61 & V600-D8KR12

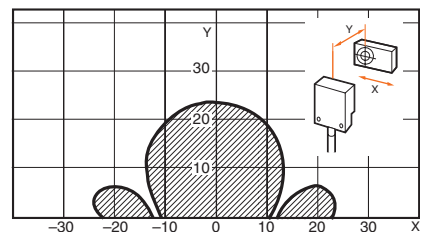

## Combinations with the V600-HS63 Sensor

V600-HS63 & V600-D23P55

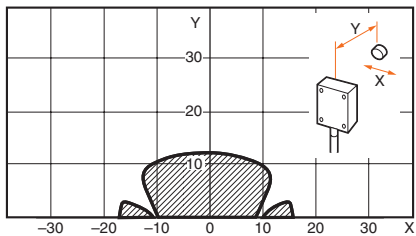

V600-HS63 & V600-D23P61

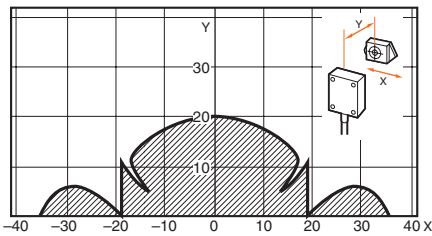

V600-HS63 & V600-D23P66N

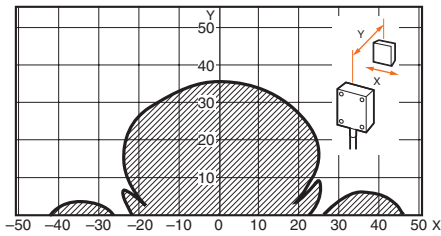

V600-HS63 & V600-D23P66SP

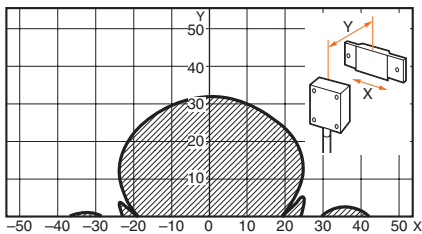

V600-HS63 & V600-D23P71

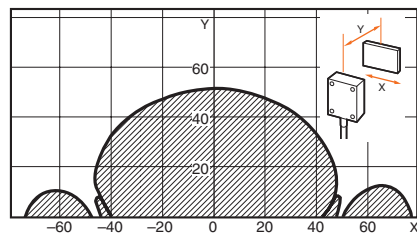

V600-HS63 & V600-D23P72

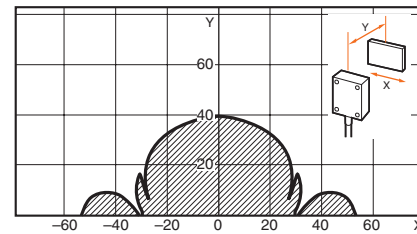

V600-HS63 & V600-D8KR12

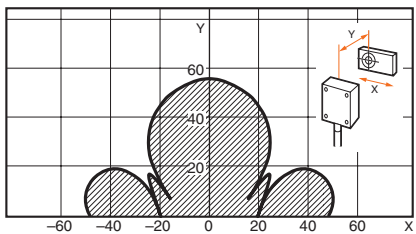

V600-HS63 & V600-D8KR04

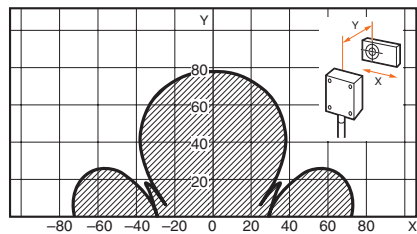

V600-HS63 & V600-D2KR16

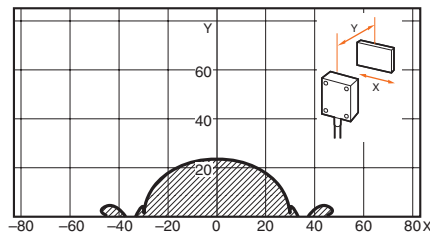

V600-HS63 & V600-D8KR13

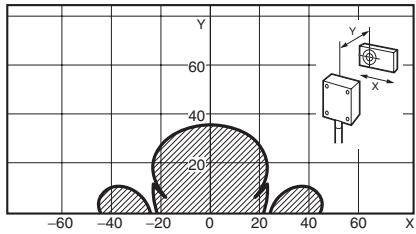

## Combinations with the V600-HS67 Sensor

V600-HS67 & V600-D23P66N

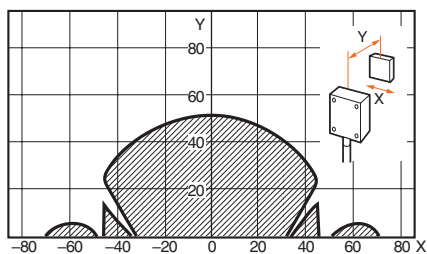

V600-HS67 & V600-D23P66SP

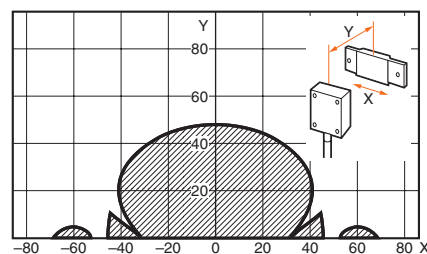

V600-HS67 & V600-D23P71

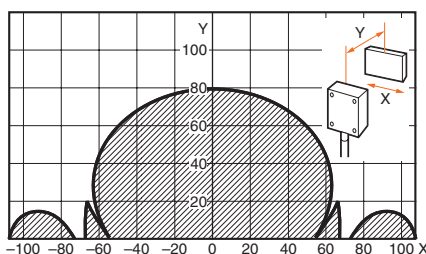

V600-HS67 & V600-D23P72

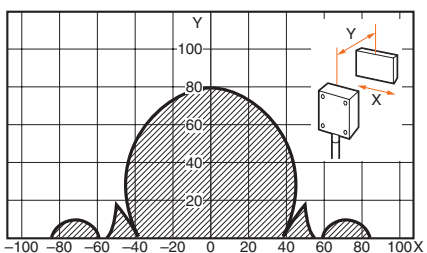

V600-HS67 & V600-D8KR12

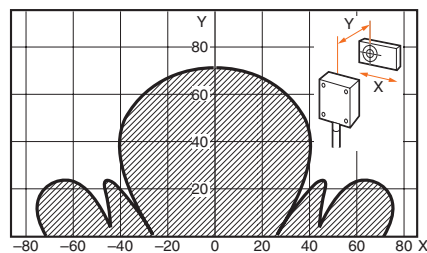

V600-HS67 & V600-D8KR13

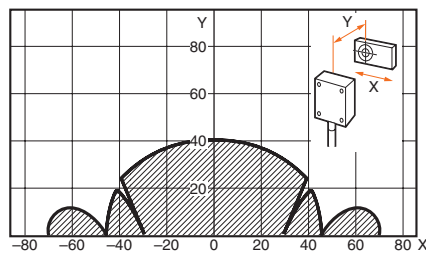

V600-HS67 & V600-D8KR04

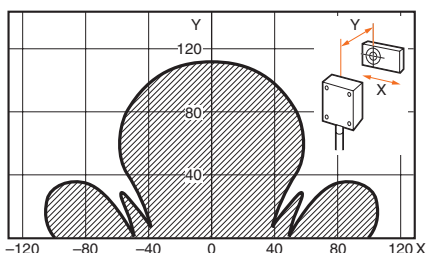

## Transmission Time

The transmission time refers to the time required for communications between the Sensor and the Data Carrier. It is used for calculating the travel speed of the auto command.

$$\text{DC speed (conveyor speed)} = \frac{\text{Distance travelled in the transmission range}}{\text{Transmission time}}$$

Model		V600-HAR91/-HAR81/-HAM91/-HAM81			V600-HAR92
		Read	Write		Read
Mode type		DATA READ mode, VERIFY READ mode	BYTE mode	BIT SET mode, BIT CLEAR mode	DATA READ mode
Data Carrier type	EEPROM	75 ms	138 ms	150 ms	77 ms
	SRAM	60 ms	95 ms	107 ms	62 ms

Example: Combinations with the V600-HAR91, V600-HS63, and V600-D8KR04 Sensors.

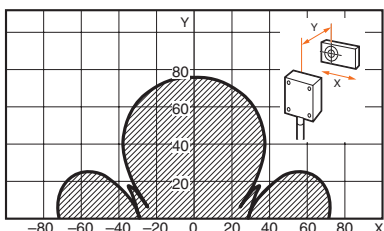

$$\text{DC speed (conveyor speed)} = \frac{75 \text{ (mm)}}{60 \text{ (ms)}} = \frac{75 \times 10^{-3} \text{ (m)}}{60 \times 10^{-3} \times 1/60 \text{ (min)}} = 75 \text{ (m/min)}$$

- Note:**
1. The DC speed varies depending on transmission distance Y and the axial offset. It is recommended that you refer to the transmission range graphs and use the product where the range is the largest.
  2. This calculation is intended as a guideline only. Perform a test with the actual product prior to use.
  3. This equation does not include transmission error processing.

# Precautions

## ■ Cautions

### ⚠ CAUTION

Be sure to house the V600-HA□91/-HA□81/-HA□92 together with their connectors and cable in control boxes when using them and do not expose them to water, oil, dust, metal powder, corrosive gas, or organic solvent, otherwise they may malfunction, suffer damage, or burn.

The connectors of the V600-HA□91/-HA□81/-HA□92 can be mounted to metal plates, provided that there is an insulation plate with a thickness of 1.5 mm minimum between each of the connectors and metal plates.

## Input/Output

The Data Input and Data Output lines are set to "1" when the transistor turns ON and to "0" when it turns OFF.

Do not use a solid-state output with the following ratings with the V600-HAM91/-HAM81, otherwise an external input error may result.

1. Maximum switching current: 1 A min.
2. Minimum switching current: 10 mA min.
3. Response time (ON to OFF): 3 ms min.

The following OMRON products cannot be connected to this product.

- CVM1-OD219, C20H, C28H, C40H, or C60H Programmable Controllers
- Sensor Controllers other than from the S3D2 Series

When using a contact output, pay careful attention to chattering and to the minimum switching current. Also note that the minimum switching current may be specified for some solid-state outputs.

When connecting an inductive load or an electrical device that tends to generate noise to the output, connect a diode in parallel with the load. Connect the cathode side of the diode to the positive side of the power source.

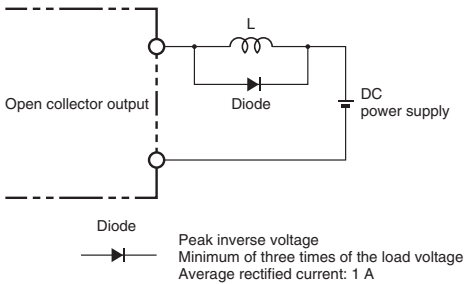

## Power Supply Voltage

Do not impose any voltage exceeding the rated voltage range. Doing so, or applying alternating current (100 VAC) may cause the product to explode or burn.

## Load Short-circuiting

Do not short-circuit the load connected to the product or connect to the power supply. Doing so may cause the product to explode or burn.

## Wiring

Avoid wiring mistakes such as incorrect polarity in the power supply. Wiring mistakes may cause the product to explode or burn.

## ■ Correct Use

### Grounding

The FG line is provided for grounding to the earth. When using the Amplifier in an environment where it is exposed to large amounts of noise or if the V600-HA□91/-HA□81/-HA□92 Amplifier malfunctions, provide a Class-3 ground (ground resistance of 100 Ω or less). Note that sharing the grounding wire with other equipment or grounding to the beam of a building will adversely affect the grounding effect.

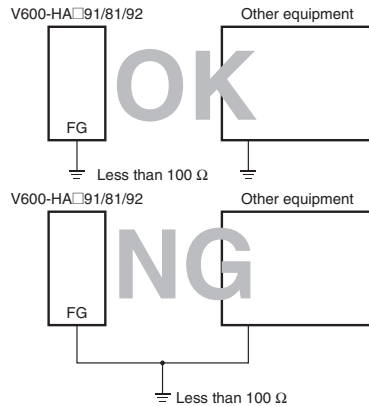

### Mounting

#### Amplifier Spacing

When installing V600-HA□91/V600-HA□81/V600-HA□92 Amplifiers in a row, provide a minimum space of 10 mm between Amplifiers in order to prevent them from being affected by the heat produced by each Amplifier.

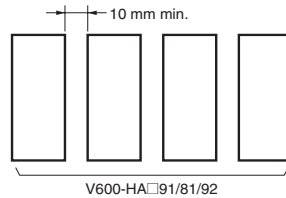

When housing the Amplifiers in a box, provide a fan or ventilation opening for radiating the heat.

When wiring power cables, which carry large current such as motor drive cables, near the V600-HA□91/81/92 Amplifiers, conduct necessary tests to make sure that the installation conditions are fully satisfied.

### I/O Interface Requirements

1. The TRG input must be 10 ms min.
2. The INHIBIT input must be 20 ms min.
3. Minimum of 5 ms is required as the transfer time of the Read/Write Selection Input (W/R).
4. The read data output must be read after the Normal End Output is set to ON.



## Connecting the Sensor

Hold the black part of the connector, line up the notch and push it in until it clicks.

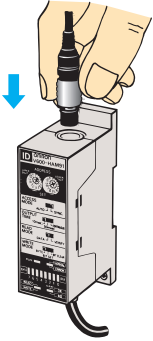

## Compatibility with the SRAM Memory Type Data Carrier

1. If the Data Carrier is stationary in the transmission area for a long time when using the V600-HA□91/81 in the AUTO mode, or when using the V600-HAR92, it will drastically reduce the battery life. Therefore, stop the oscillation in the sensor either by turning off the power of the V600-HA□91/81/92 Amplifier or by setting the Inhibit input to ON.
2. Use a Data Carrier that has the oscillation frequency of 530 kHz. Note that the following models manufactured before February 1991 cannot be used.
  - V600-D2KR01
  - V600-D2KR02

## Precautions When Using the AUTO Mode

If transmitting to the Data Carrier while it is traveling under the AUTO mode, conduct tests to make sure that the travel speed and installation conditions are fully satisfied.

## Dimensions

**Note:** All units are in millimeters unless otherwise indicated.

### Amplifier

V600-HAR91/-HAR81

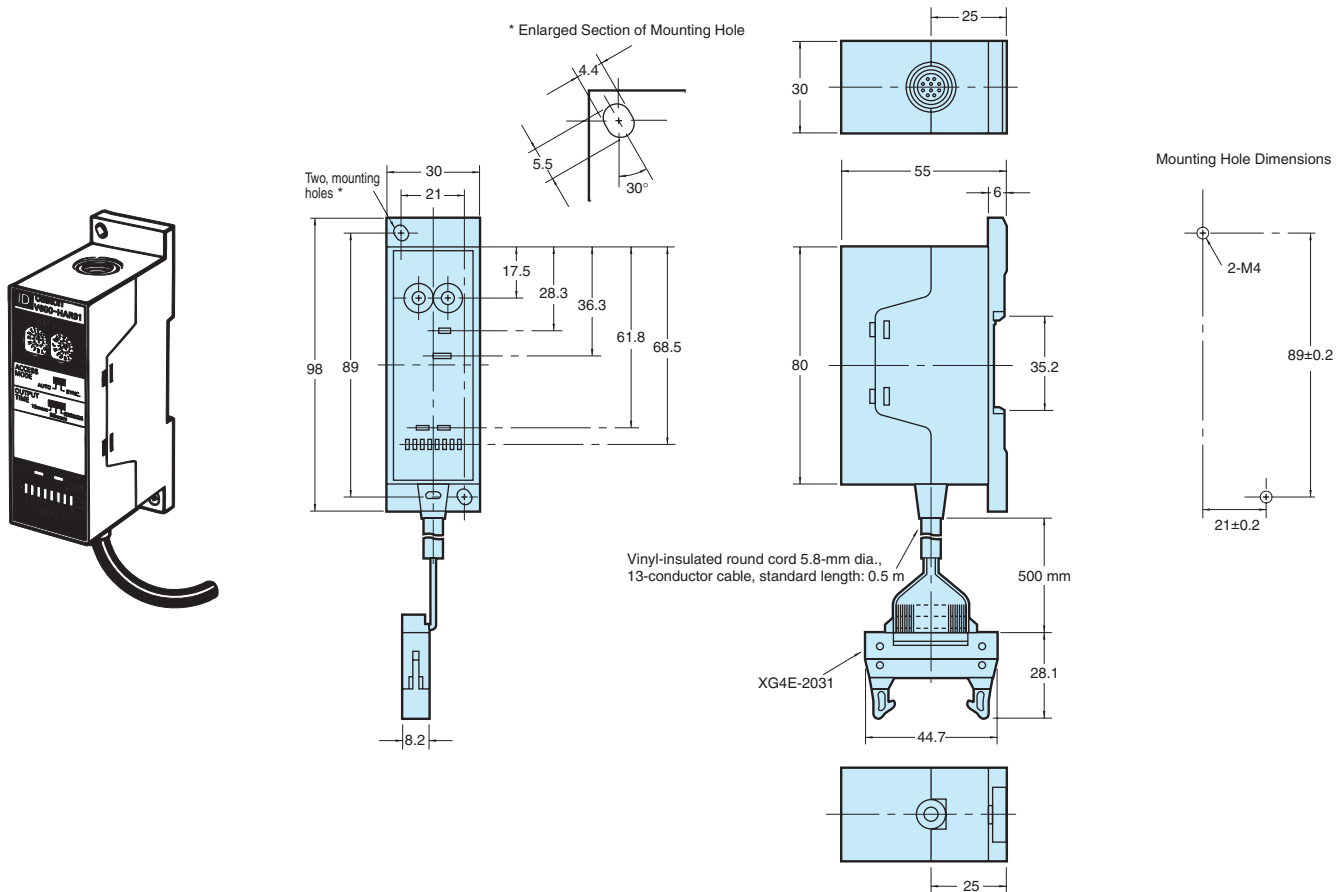

V600-HAM91/-HAM81

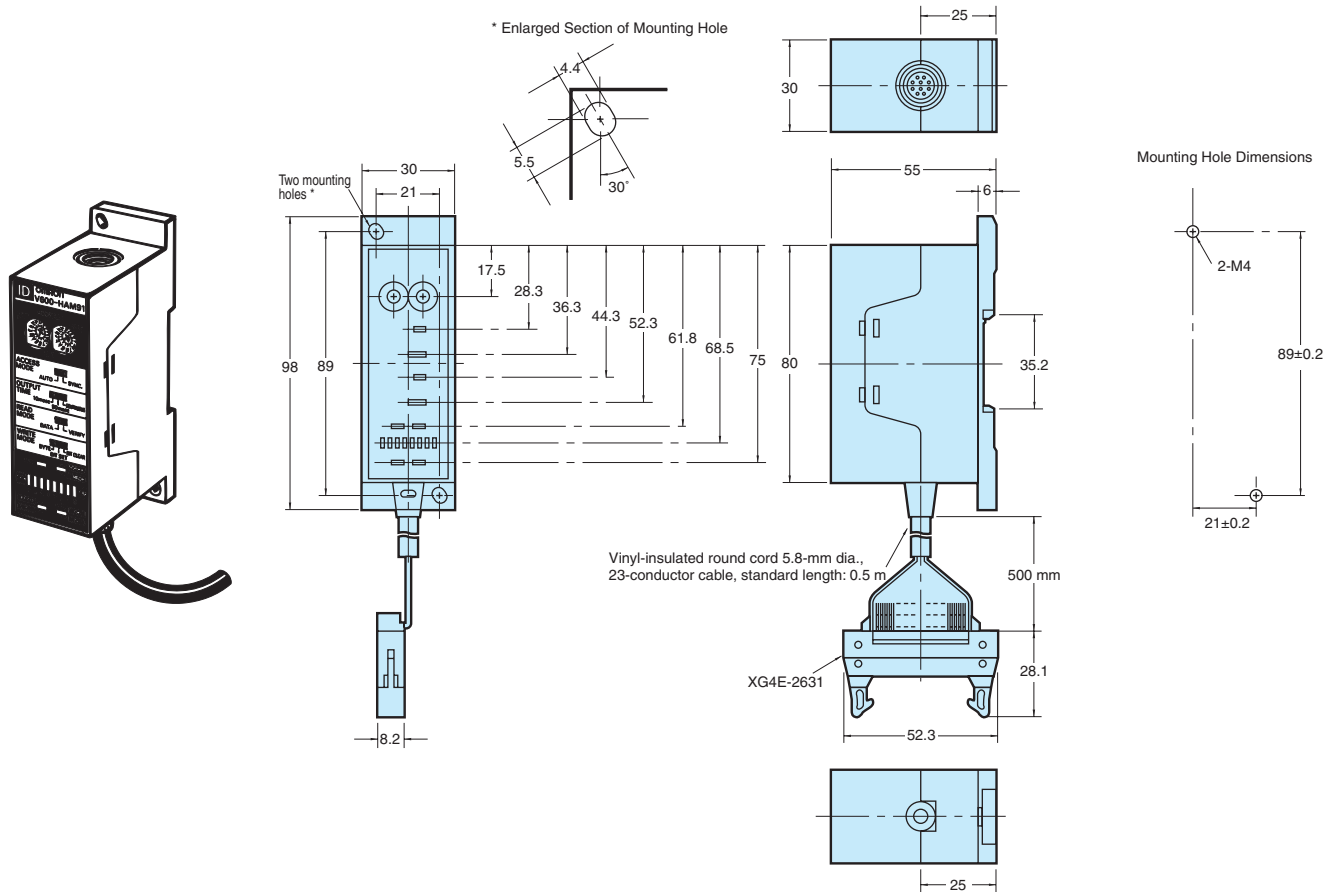

V600-HAR92

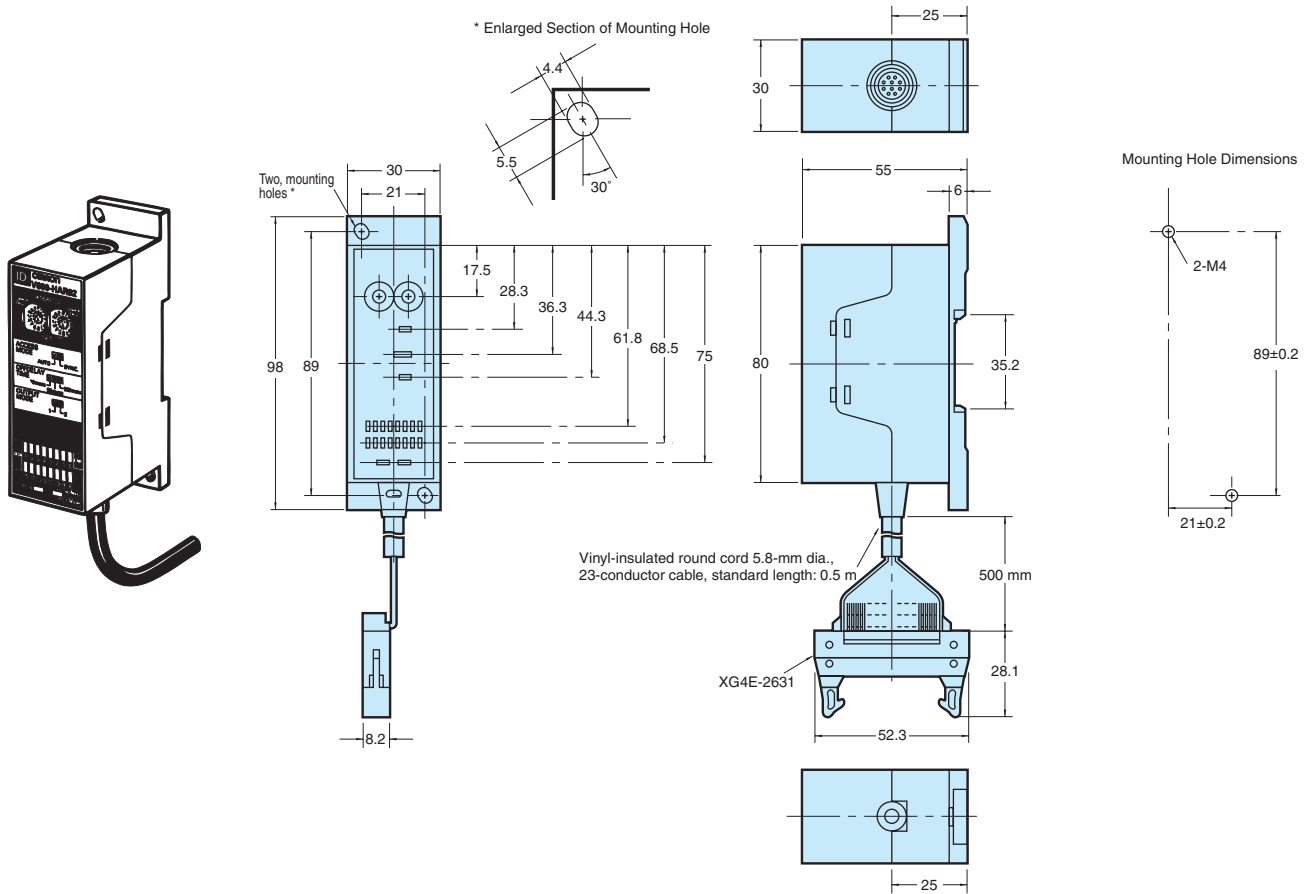

Sensor

V600-HS51

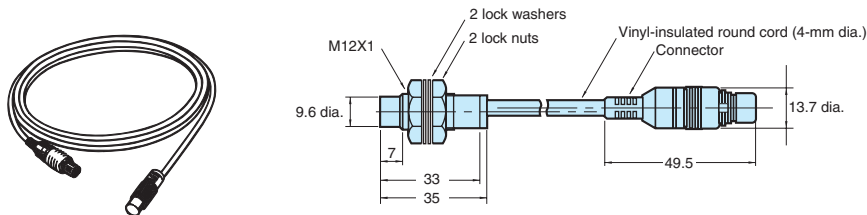

V600-HS61

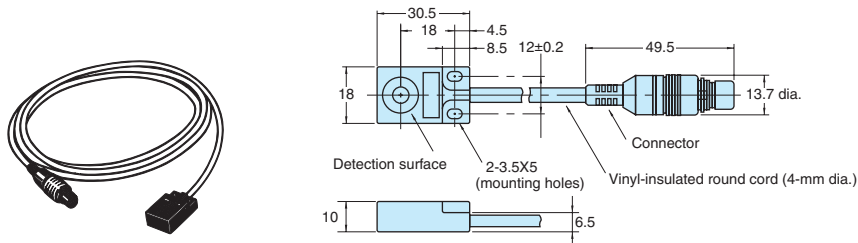

V600-HS63

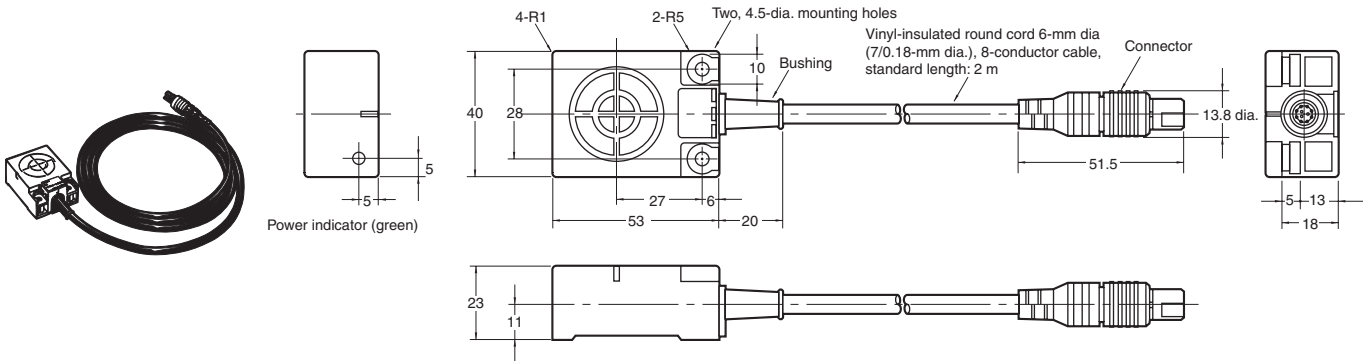

V600-HS67

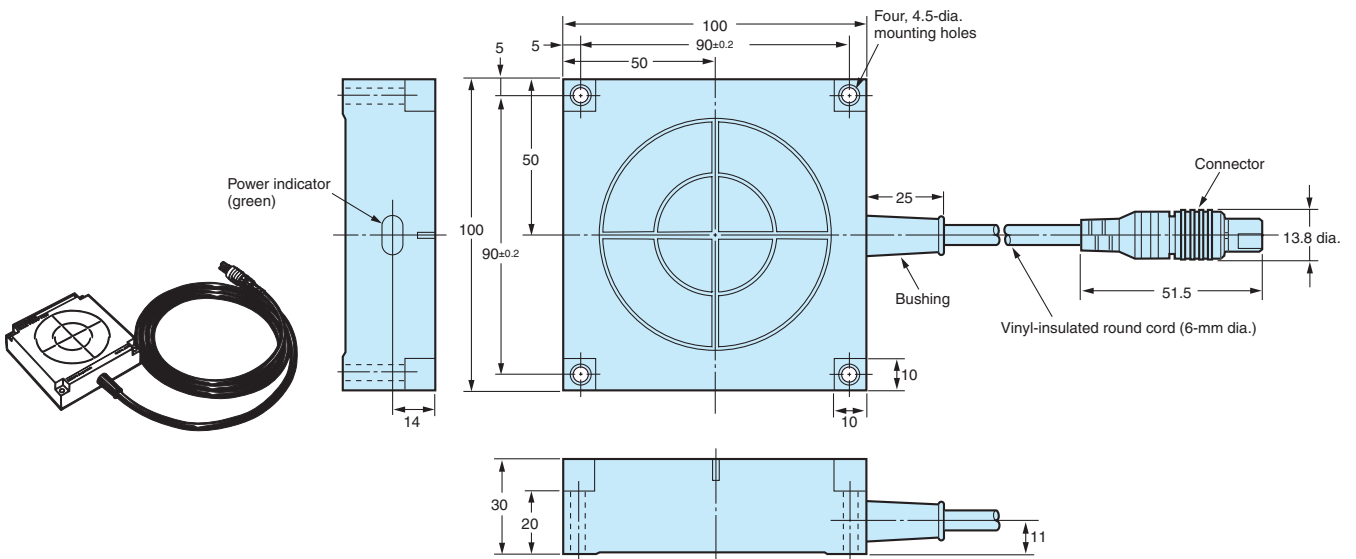

Interface Cable

V600-A6□R (for V600-HAR91/-HAR81)

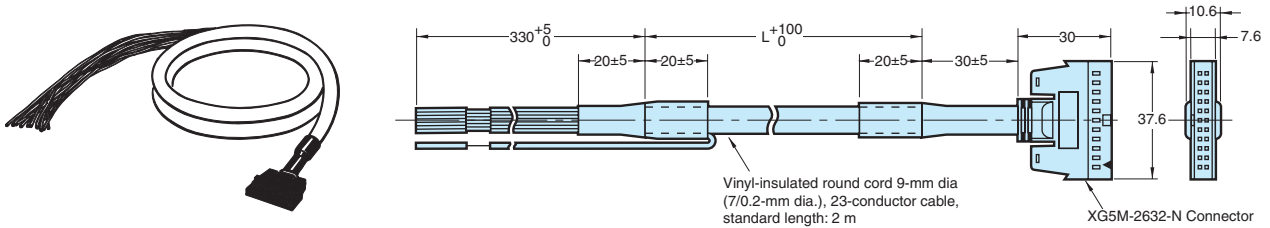

V600-A6□M (for V600-HAM91/-HAM81/-HAR92)

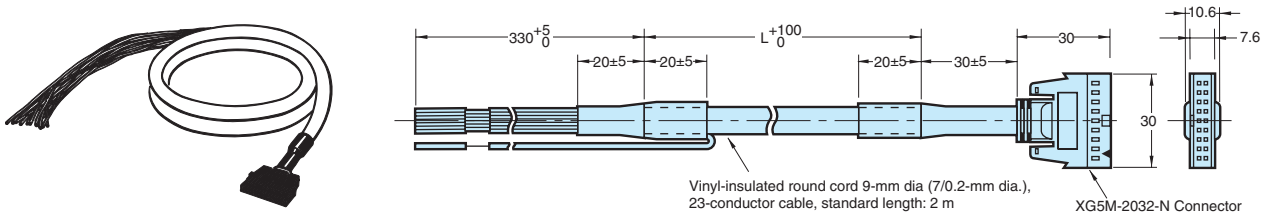

Model	L (m)
V600-A60R/60M	2
V600-A61R/61M	5
V600-A62R/62M	10

## V600-series Data Carrier

### Built-in-battery DCs

#### V600-D8KR12

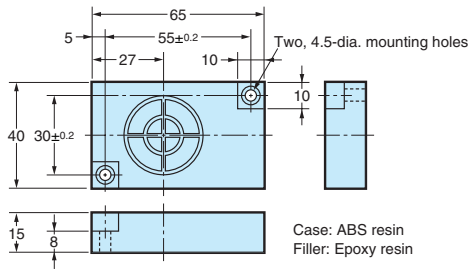

#### V600-D8KR13

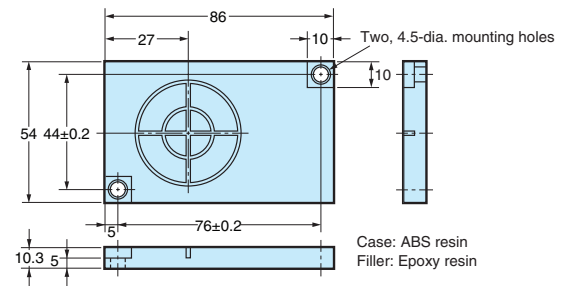

#### V600-D8KR04

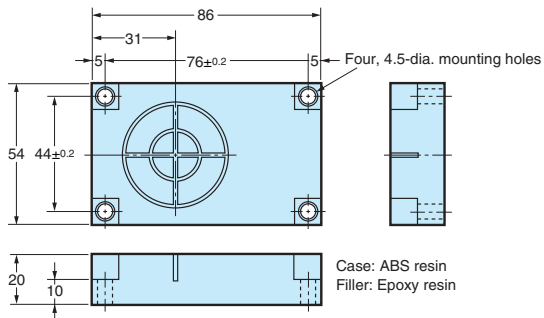

### Replaceable-battery DCs

#### V600-D2KR16

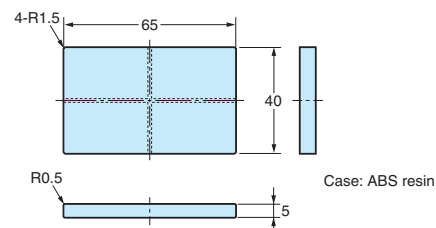

### Battery-less DCs

#### V600-D23P53

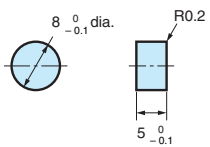

Case: ABS resin  
Filler: Epoxy resin

#### V600-D23P54

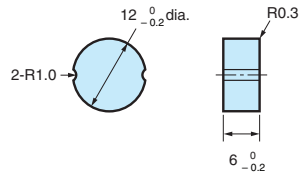

Case: ABS resin  
Filler: Epoxy resin

#### V600-D23P55

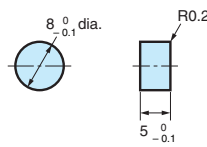

Case: PPS resin  
Filler: Epoxy resin

#### V600-D23P61

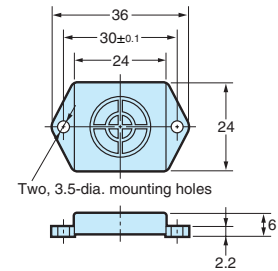

#### V600-D23P66N

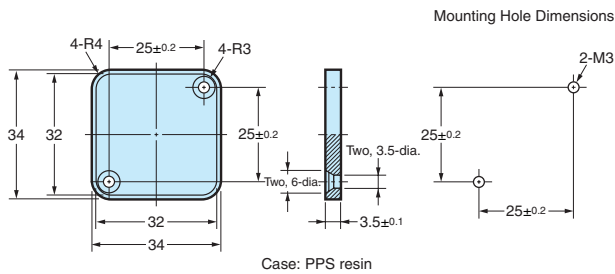

#### V600-D23P66SP

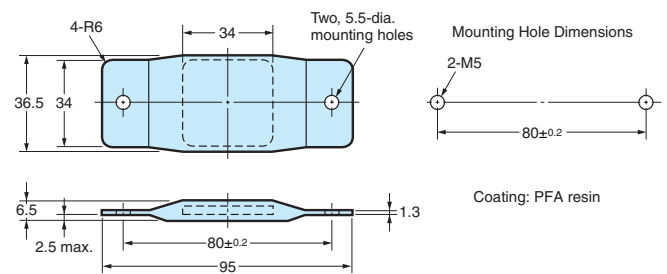

V600-D23P71

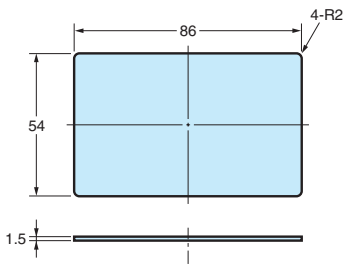

Case: Glass epoxy resin  
Coating: Polyurethane resin

V600-D23P72

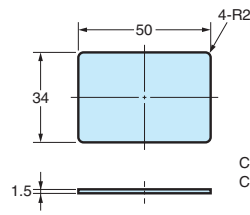

Case: Glass epoxy resin  
Coating: Polyurethane resin

ALL DIMENSIONS SHOWN ARE IN MILLIMETERS.  
To convert millimeters into inches, multiply by 0.03937. To convert grams into ounces, multiply by 0.03527.

## **READ AND UNDERSTAND THIS DOCUMENT**

Please read and understand this document before using the products. Please consult your OMRON representative if you have any questions or comments.

## **WARRANTY**

OMRON's exclusive warranty is that the products are free from defects in materials and workmanship for a period of one year (or other period if specified) from date of sale by OMRON.

OMRON MAKES NO WARRANTY OR REPRESENTATION, EXPRESS OR IMPLIED, REGARDING NON-INFRINGEMENT, MERCHANTABILITY, OR FITNESS FOR PARTICULAR PURPOSE OF THE PRODUCTS. ANY BUYER OR USER ACKNOWLEDGES THAT THE BUYER OR USER ALONE HAS DETERMINED THAT THE PRODUCTS WILL SUITABLY MEET THE REQUIREMENTS OF THEIR INTENDED USE. OMRON DISCLAIMS ALL OTHER WARRANTIES, EXPRESS OR IMPLIED.

## **LIMITATIONS OF LIABILITY**

OMRON SHALL NOT BE RESPONSIBLE FOR SPECIAL, INDIRECT, OR CONSEQUENTIAL DAMAGES, LOSS OF PROFITS OR COMMERCIAL LOSS IN ANY WAY CONNECTED WITH THE PRODUCTS, WHETHER SUCH CLAIM IS BASED ON CONTRACT, WARRANTY, NEGLIGENCE, OR STRICT LIABILITY.

In no event shall responsibility of OMRON for any act exceed the individual price of the product on which liability is asserted.

IN NO EVENT SHALL OMRON BE RESPONSIBLE FOR WARRANTY, REPAIR, OR OTHER CLAIMS REGARDING THE PRODUCTS UNLESS OMRON'S ANALYSIS CONFIRMS THAT THE PRODUCTS WERE PROPERLY HANDLED, STORED, INSTALLED, AND MAINTAINED AND NOT SUBJECT TO CONTAMINATION, ABUSE, MISUSE, OR INAPPROPRIATE MODIFICATION OR REPAIR.

## **SUITABILITY FOR USE**

THE PRODUCTS CONTAINED IN THIS DOCUMENT ARE NOT SAFETY RATED. THEY ARE NOT DESIGNED OR RATED FOR ENSURING SAFETY OF PERSONS, AND SHOULD NOT BE RELIED UPON AS A SAFETY COMPONENT OR PROTECTIVE DEVICE FOR SUCH PURPOSES. Please refer to separate catalogs for OMRON's safety rated products.

OMRON shall not be responsible for conformity with any standards, codes, or regulations that apply to the combination of products in the customer's application or use of the product.

At the customer's request, OMRON will provide applicable third party certification documents identifying ratings and limitations of use that apply to the products. This information by itself is not sufficient for a complete determination of the suitability of the products in combination with the end product, machine, system, or other application or use.

The following are some examples of applications for which particular attention must be given. This is not intended to be an exhaustive list of all possible uses of the products, nor is it intended to imply that the uses listed may be suitable for the products:

- Outdoor use, uses involving potential chemical contamination or electrical interference, or conditions or uses not described in this document.
- Nuclear energy control systems, combustion systems, railroad systems, aviation systems, medical equipment, amusement machines, vehicles, safety equipment, and installations subject to separate industry or government regulations.
- Systems, machines, and equipment that could present a risk to life or property.

Please know and observe all prohibitions of use applicable to the products.

NEVER USE THE PRODUCTS FOR AN APPLICATION INVOLVING SERIOUS RISK TO LIFE OR PROPERTY WITHOUT ENSURING THAT THE SYSTEM AS A WHOLE HAS BEEN DESIGNED TO ADDRESS THE RISKS, AND THAT THE OMRON PRODUCT IS PROPERLY RATED AND INSTALLED FOR THE INTENDED USE WITHIN THE OVERALL EQUIPMENT OR SYSTEM.

## **PERFORMANCE DATA**

Performance data given in this document is provided as a guide for the user in determining suitability and does not constitute a warranty. It may represent the result of OMRON's test conditions, and the users must correlate it to actual application requirements. Actual performance is subject to the OMRON Warranty and Limitations of Liability.

## **CHANGE IN SPECIFICATIONS**

Product specifications and accessories may be changed at any time based on improvements and other reasons.

It is our practice to change model numbers when published ratings or features are changed, or when significant construction changes are made. However, some specifications of the product may be changed without any notice. When in doubt, special model numbers may be assigned to fix or establish key specifications for your application on your request. Please consult with your OMRON representative at any time to confirm actual specifications of purchased products.

## **DIMENSIONS AND WEIGHTS**

Dimensions and weights are nominal and are not to be used for manufacturing purposes, even when tolerances are shown.

## **ERRORS AND OMISSIONS**

The information in this document has been carefully checked and is believed to be accurate; however, no responsibility is assumed for clerical, typographical, or proofreading errors, or omissions.

## **PROGRAMMABLE PRODUCTS**

OMRON shall not be responsible for the user's programming of a programmable product, or any consequence thereof.

## **COPYRIGHT AND COPY PERMISSION**

This document shall not be copied for sales or promotions without permission.

This document is protected by copyright and is intended solely for use in conjunction with the product. Please notify us before copying or reproducing this document in any manner, for any other purpose. If copying or transmitting this document to another, please copy or transmit it in its entirety.

Cat. No. Q104-E1-03

In the interest of product improvement, specifications are subject to change without notice.

---

## **OMRON Corporation**

Industrial Automation Company

Application Sensors Division  
Sensing Devices and Components Division H.Q.  
Shiokoji Horikawa, Shimogyo-ku,  
Kyoto, 600-8530 Japan  
Tel: (81)75-344-7068/Fax: (81)75-344-7107

Printed in Japan  
1004





# Mouser Electronics

Authorized Distributor

Click to View Pricing, Inventory, Delivery & Lifecycle Information:

Omron:

[V600-HAM91](#) [V600-HAR81](#) [V600-HAM81](#)

Компания «Океан Электроники» предлагает заключение долгосрочных отношений при поставках импортных электронных компонентов на взаимовыгодных условиях!

Наши преимущества:

- Поставка оригинальных импортных электронных компонентов напрямую с производств Америки, Европы и Азии, а так же с крупнейших складов мира;
- Широкая линейка поставок активных и пассивных импортных электронных компонентов (более 30 млн. наименований);
- Поставка сложных, дефицитных, либо снятых с производства позиций;
- Оперативные сроки поставки под заказ (от 5 рабочих дней);
- Экспресс доставка в любую точку России;
- Помощь Конструкторского Отдела и консультации квалифицированных инженеров;
- Техническая поддержка проекта, помощь в подборе аналогов, поставка прототипов;
- Поставка электронных компонентов под контролем ВП;
- Система менеджмента качества сертифицирована по Международному стандарту ISO 9001;
- При необходимости вся продукция военного и аэрокосмического назначения проходит испытания и сертификацию в лаборатории (по согласованию с заказчиком);
- Поставка специализированных компонентов военного и аэрокосмического уровня качества (Xilinx, Altera, Analog Devices, Intersil, Interpoint, Microsemi, Actel, Aeroflex, Peregrine, VPT, Syfer, Eurofarad, Texas Instruments, MS Kennedy, Miteq, Cobham, E2V, MA-COM, Hittite, Mini-Circuits, General Dynamics и др.);

Компания «Океан Электроники» является официальным дистрибьютором и эксклюзивным представителем в России одного из крупнейших производителей разъемов военного и аэрокосмического назначения «JONHON», а так же официальным дистрибьютором и эксклюзивным представителем в России производителя высокотехнологичных и надежных решений для передачи СВЧ сигналов «FORSTAR».



## JONHON

«JONHON» (основан в 1970 г.)

Разъемы специального, военного и аэрокосмического назначения:

(Применяются в военной, авиационной, аэрокосмической, морской, железнодорожной, горно- и нефтедобывающей отраслях промышленности)

«FORSTAR» (основан в 1998 г.)

ВЧ соединители, коаксиальные кабели, кабельные сборки и микроволновые компоненты:

(Применяются в телекоммуникациях гражданского и специального назначения, в средствах связи, РЛС, а так же военной, авиационной и аэрокосмической отраслях промышленности).



Телефон: 8 (812) 309-75-97 (многоканальный)

Факс: 8 (812) 320-03-32

Электронная почта: [ocean@oceanchips.ru](mailto:ocean@oceanchips.ru)

Web: <http://oceanchips.ru/>

Адрес: 198099, г. Санкт-Петербург, ул. Калинина, д. 2, корп. 4, лит. А