

Z1 Foil Ultra High Precision Wrap-around Chip Resistor for Improved Load Life Stability of 0.0025% (25 ppm) with TCR of ± 0.05 ppm/°C and withstands ESD of 25 KV min

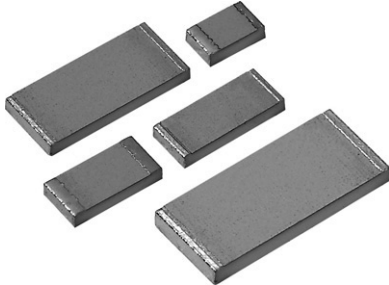

Top View

INTRODUCTION

The FRSM is based on the new generation Z1-technology of the Bulk Metal® Precision Foil resistor elements by Vishay Precision Group (VPG), which makes these resistors virtually insensitive to destabilizing factors. Their element, based on the new Z1 Foil is a solid alloy that displays the desirable bulk properties of its parent material; thus, it is inherently stable (remarkably improved load life stability of 25 ppm), noise-free and withstands ESD to 25KV or more. The alloy is matched to the substrate and forms a single entity with balanced temperature characteristics for an unusually low and predictable TCR over a wide range from -55 °C to more than 175°C. Resistance patterns are photo-etched to permit trimming of resistance values to very tight tolerances.

Our application engineering department is available to advise and make recommendations. For non-standard technical requirements and special applications, please contact us using the e-mail address in the footer below.

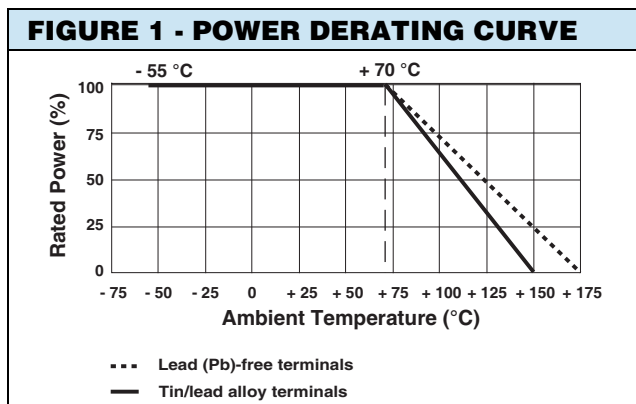

FEATURES

- Temperature coefficient of resistance (TCR):
0.05 ppm/°C typical (0 °C to + 60 °C)
0.2 ppm/°C typical (- 55 °C to + 125 °C, + 25 °C ref.)
- Resistance tolerance: to ± 0.01 %
- Power coefficient "ΔR due to self heating":
5 ppm at rated power
- Power rating: to 750 mW at + 70 °C
- **Load life stability:**
 ± 0.0025 % at 70 °C, 2000 h at rated power.
 ± 0.005 % at 70 °C, 10,000 h at rated power.
- Resistance Range: 5 Ω to 125 kΩ (for higher and lower values, please contact us)
- Vishay Foil resistors are not restricted to standard values; we can supply specific "as required" values at no extra cost or delivery (e.g. 1K2345 vs. 1K)
- Thermal stabilization time < 1 s (nominal value achieved within 10 ppm of steady state value)
- **Electrostatic discharge (ESD) at least to 25kV**
- Short time overload: 0.005 %
- Rise time: 1 ns effectively no ringing
- Current noise: 0.010 μV_{RMS}/V of applied voltage (< - 40 dB)
- Voltage coefficient: 0.1 ppm/V
- Non inductive: 0.08 μH
- Non hot spot design
- Terminal finishes available: lead (Pb)-free, tin/lead alloy⁽¹⁾
- Matched sets are available on request
- Prototype quantities available in just 5 working days or sooner. For more information, please contact foil@vpgsensors.com
- For higher temperature application up to +240 °C and for better performances, please contact us



RoHS*
COMPLIANT

TABLE 1 - TOLERANCE AND TCR VS. RESISTANCE VALUE (1)
(- 55 °C to + 125 °C, + 25 °C Ref.)

RESISTANCE VALUE (Ω)	TOLERANCE (%)	TYPICAL TCR AND MAX. SPREAD (ppm/°C)
250 to 125K	± 0.01	$\pm 0.2 \pm 1.8$
100 to < 250	± 0.02	$\pm 0.2 \pm 1.8$
50 to < 100	± 0.05	$\pm 0.2 \pm 2.8$
25 to < 50	± 0.1	$\pm 0.2 \pm 3.8$
10 to < 25	± 0.25	$\pm 0.2 \pm 3.8$
5 to < 10	± 0.5	$\pm 0.2 \pm 7.8$

⁽¹⁾ Pb containing terminations are not RoHS compliant, exemptions may apply.

ABOUT THE FRSM

Several factors need to be considered when choosing a resistor for applications that require long term stability, including TCR (ambient temperature), Power TCR (self heating), load-life stability for more than 10K hours (instead of the typical 1000 or 2000 hours load-life), end-of-life tolerance (which is more important than the initial tolerance), thermal EMF (low values, D.C), thermal stabilization and ESD. Some precision resistor technologies such as Precision Thin Film offer designers tight initial tolerances as low as 0.02 % but have poor load life stability, high end-of-life tolerance, long thermal stabilization, high drifts during operational life and ESD sensitivity. Other resistor technologies, such as Wirewounds, provide low absolute TCR and excellent current noise of -40 dB but have high inductance and poor rise time (or thermal lag) for more than a few seconds.

There are essentially only three resistance technologies widely used for precision resistors in military and space applications: Thin Film, Wirewound and Bulk Metal® Foil. Each has its own balance of characteristics and costs that justify its selection in these applications. Thin Films are most cost-efficient within their normal range of characteristics but have the highest TCR, highest noise and have the least stability of the three technologies. Wirewounds have low noise, low TCR and a high level of stability at moderate cost but also have high impedance and slow signal response. Wirewounds can also have a higher power density, but some stability is lost through temperature cycling and load-life when made in smaller configurations. Bulk Metal® Foil resistors have the lowest noise, lowest TCR, highest stability and highest speed of any technology but may have a higher cost, depending upon model. With Bulk Metal® Foil resistors, savvy designers often save overall by concentrating the circuit stability in the foil resistors where exceptional stability allows for use of less-costly active devices---an option not available with other resistor technologies because foil requires a smaller total error budget through all cumulative resistor life exposures. Also, foil often eliminates extra circuitry added merely for the purpose of correcting the limitations of other resistor components. FRSM's Bulk Metal® Foil resistors, based on new generation technology and improved production methods starting from February 2011, offer designers the complete set of top performance characteristics to simplify circuitry and lower overall system costs by reducing the number of required parts while assuring a better end product. The new series of FRSM feature a long-term load-life stability within 0.0025 % after 2000 hours and 0.005% after 10000 hours under full rated power at + 70 °C, first time in the history of all resistor technologies. In addition to their low absolute TCR of almost zero TCR, the devices offer Power TCR ("ΔR due to self heating") to ±5 ppm at rated power; tight tolerance from 0.01% and thermal EMF of 0.05 μV/°C. Current design practice has been to over specify resistors to allow for expected tolerance degradation during service and there is a trend to move to commercial off the shelf (COTS) parts instead of MIL spec Qualified (QPL) parts. Vishay Precision Group offers a new approach with lower prices to bring Foil resistors within the reach of designers whose end-of-life tolerance target is 0.05 % (total end of life cumulative deviation from nominal) or less with COTS resistors having all the inherent features for long term reliability.

While other resistor technologies can take several seconds or even minutes to achieve a steady state thermal stabilization (thermal lag), Vishay Foil resistors feature an almost instantaneous thermal stabilization time and a nearly immeasurable 1 ns rise time effectively with no ringing. The stress levels of each application are different so the designer must make an estimation of what they might be and assign a stress factor to each one. The stress may normally be low but for these purposes, we must assure that the installed precision resistor is capable of reliability withstanding all potential stresses. For example, if the resistor is installed in a piece of equipment that is expected to go out into an oil field in the back of a pickup truck, shock and vibration and heat from the sun are obvious factors. The specific causes of resistor drift are listed in Table 4 and the allowances shown are for full scale exposure. The designer may choose to use a percentage of full scale stress factor if the equipment will never see the full scale conditions. For example, a laboratory instrument that is expected to be permanently installed in an air-conditioned laboratory does not need an end-of-life allowance for excessive heat. There are other reasons for tolerancing the resistors tighter than the initial calculation: Measurement equipment accuracy is traditionally ten times better than the expected accuracy of the devices under test. So, these tighter tolerance applications require a Foil resistor. Also, the drift of the resistor without any stress factor considerations results in a shift over time that must be considered. FRSMs have the least amount of time shift. The manufacturer's recommended recalibration cycle is a factor in the saleability of the product and the longer the cycle, the more acceptable the product. Foil resistors contribute significantly to the longer calibration cycle.

FIGURE 2 - TRIMMING TO VALUES*
(Conceptual Illustration)

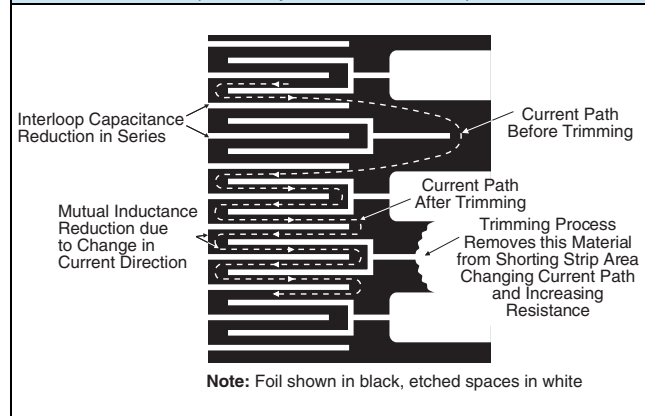

* To acquire a precision resistance value, the Bulk Metal® Foil chip is trimmed by selectively removing built-in "shorting bars." To increase the resistance in known increments, marked areas are cut, producing progressively smaller increases in resistance. This method eliminates "hot spot" and improves the long term stability of the resistor.

FIGURE 3 - TYPICAL RESISTANCE/TEMPERATURE CURVE(2)

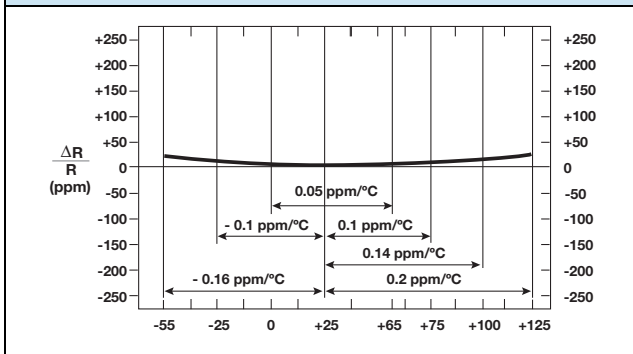
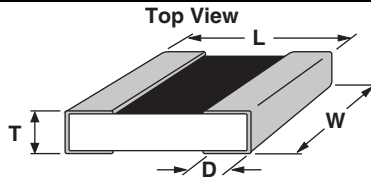

TABLE 3 - SPECIFICATIONS(1)

CHIP SIZE	RATED POWER (mW) at +70 °C	MAX. WORKING VOLTAGE ($\leq \sqrt{P \times R}$)	RESISTANCE RANGE (Ω)	MAXIMUM WEIGHT (mg)
0402 ⁽³⁾	50	5 V	100 to 500	2
0603	100	22 V	100 to 4K*	4
0805	200	40 V	5 to 8K	6
1206	300	87 V	5 to 25K	11
1506	300	95 V	5 to 30K	12
2010	500	187 V	5 to 70K	27
2512	750	220 V	5 to 125K	40

* For 0603 values between 4K and 5K, please contact us

TABLE 2 - DIMENSIONS in Inches (Millimeters)



CHIP SIZE	L ± 0.005 (0.13)	W ± 0.005 (0.13)	THICKNESS MAXIMUM	D ± 0.005 (0.13)
0603	0.063 (1.60)	0.032 (0.81)	0.025 (0.64)	0.011 (0.28)
0805	0.080 (2.03)	0.050 (1.27)	0.025 (0.64)	0.015 (0.38)
1206	0.126 (3.20)	0.062 (1.57)	0.025 (0.64)	0.020 (0.51)
1506	0.150 (3.81)	0.062 (1.57)	0.025 (0.64)	0.020 (0.51)
2010	0.198 (5.03)	0.097 (2.46)	0.025 (0.64)	0.025 (0.64)
2512	0.249 (6.32)	0.127 (3.23)	0.025 (0.64)	0.032 (0.81)

Notes

- (1) For tighter performances and non-standard values up to 150K, please contact VPG application engineering using the e-mail addresses in the footer below.
- (2) The TCR values for < 100 Ω are influenced by the termination composition and result in deviation from this curve.

TABLE 4 - PERFORMANCES

TEST OR CONDITIONS	ΔR LIMITS OF PRECISION THIN FILM	TYPICAL ΔR LIMITS OF FRSM SERIES	MAXIMUM ΔR LIMITS OF FRSM SERIES ⁽³⁾
Thermal Shock, 100 x (-65 °C to +150 °C) (see Figure 6)	± 0.1 %	± 0.005% (50 ppm)	± 0.01% (100 ppm)
Low Temperature Operation, -65 °C, 45 min at P _{nom}	± 0.1 %	± 0.0025% (25 ppm)	± 0.005% (50 ppm)
Short Time Overload, 6.25 x Rated Power, 5 s	± 0.1 %	± 0.005% (50 ppm)	± 0.01% (100 ppm)
High Temperature Exposure, +150 °C, 100 h	± 0.1 %	± 0.0025% (25 ppm)	± 0.005% (50 ppm)
Resistance to Soldering Heat, +245°C for 5 sec, +235°C for 30 sec	± 0.1 %	± 0.005 % (50 ppm)	± 0.01% (100 ppm)
Moisture Resistance	± 0.1 %	± 0.003% (30 ppm)	± 0.01% (100 ppm)
Load Life Stability +70 °C for 2000 h at Rated Power (see Figure 8)	± 0.1 %	0.0025% (25 ppm)	± 0.005% (50ppm)
Load Life Stability +70 °C for 10,000 h at Rated Power	± 0.5 %	0.005% (50 ppm)	± 0.015% (150ppm)

Note

- (3) As shown + 0.01 Ω to allow for measurement errors at low values.

FIGURE 4 - RECOMMENDED MOUNTING

Notes

- (1) IR and vapor phase reflow are recommended.
- (2) Avoid the use of cleaning agents which could attack epoxy resins, which form part of the resistor construction
- (3) Vacuum pick up is recommended for handling
- (4) If the use of a soldering iron becomes necessary, precautionary measures should be taken to avoid any possible damage / overheating of the resistor

* Recommendation: The solder fillet profile should be such as to avoid running over the top metallization

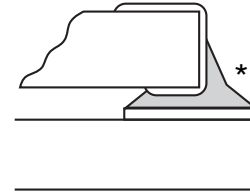

PULSE TEST

TEST DESCRIPTION

All parts baked at +125°C for 1 hr and allowed to cool at room temperature for 1 hr, prior to testing. By using an electrolytic 0.01µF capacitor charged to 1000 VDC, a single pulse was performed on 20 units of 1206, for each value: 100Ω, 1KΩ and 10KΩ of Surface Mount Vishay Foil resistor and Thin Film resistor. The unit was allowed time to cool down, after which the resistance measurement was taken and displayed in ppm deviation from the initial reading.

TEST RESULTS

FIGURE 5 - PULSE TEST DESCRIPTION

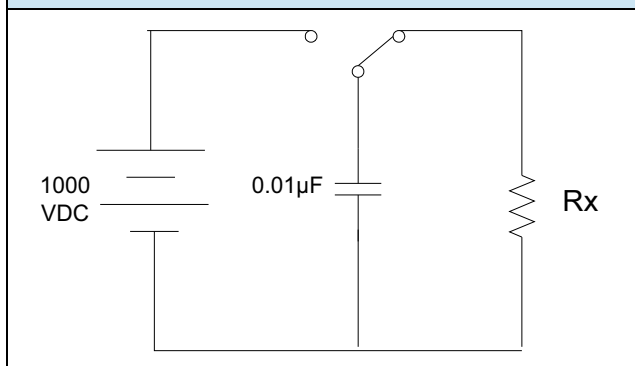
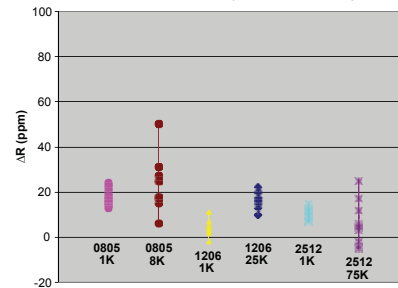

TABLE 5 - PULSE TEST RESULTS

VALUE	VOLTAGE	T= RC	AVERAGE DEVIATION (%)	
			VISHAY FOIL RESISTOR	THIN FILM
100R	1000VDC	1µsec	<0.001	Open
1K		10 µsec		>35
10K		100 µsec		>0.008

FIGURE 6 - THERMAL SHOCK TEST

Test per MIL PRF 55342 4.8.3 Mil STD 202, Method 107
Test Conditions: 100 X (-65°C to +150°C), n=10



ELECTROSTATIC DISCHARGE (ESD)

ESD can be categorized into three types of damages

Parametric Failure - occurs when the ESD event alters one or more device parameters (resistance in the case of resistors), causing it to shift from its required tolerance. This failure does not directly pertain to functionality; thus a parametric failure may be present while the device is still functional.

Catastrophic Damage - occurs when the ESD event causes the device to immediately stop functioning. This may occur after one or a number of ESD events with diverse causes, such as human body discharge or the mere presence of an electrostatic field.

Latent Damage - occurs when the ESD event causes moderate damage to the device, which is not noticeable, as the device appears to be functioning correctly. However, the load life of the device has been dramatically reduced, and further degradation caused by operating stresses may cause the device to fail during service. Latent damage is the source for greatest concern, since it is very difficult to detect by re-measurement or by visual inspection, since damage may have occurred under the external coating.

TEST DESCRIPTION

By using an electrolytic 500 pF capacitor charged up to 4500 V, pulses were performed on 10 units of 1206, 10KΩ of three different Surface Mount Chip Resistors technologies, with an initial voltage spike of 2500 V (Figure 7). The unit was allowed time to cool down, after which the resistance measurement was taken and displayed in ppm deviation from the initial reading. Readings were then taken in 500 V increments up to 4500 V.

TEST RESULTS

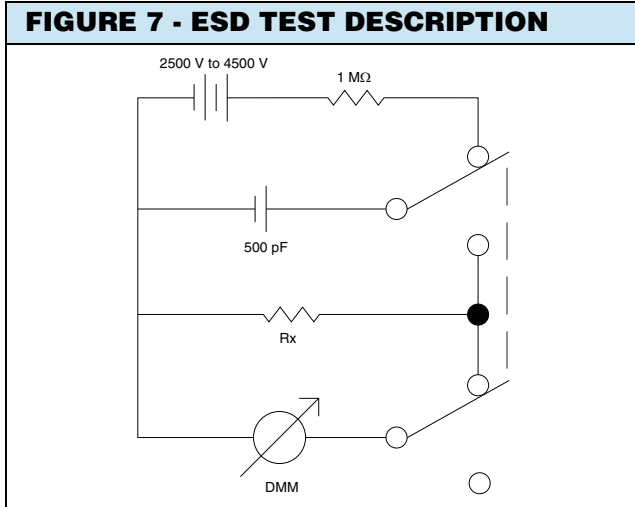
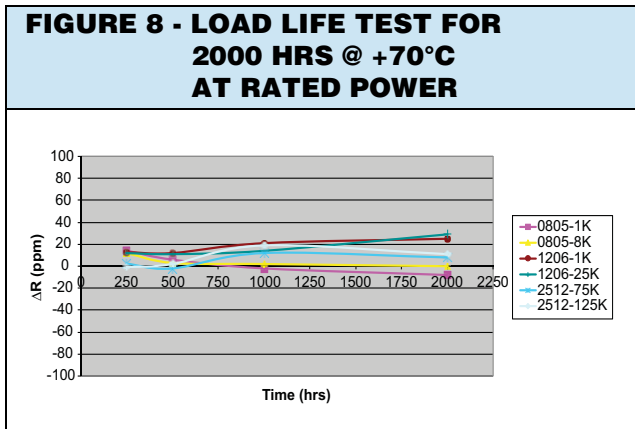

TABLE 6 - ESD TEST RESULTS

VOLTS	ΔR (%)		
	THICK FILM	THIN FILM	FOIL
2500	-2.7	97	<0.005
3000	-4.2	366	<0.005
3500	-6.2	>5000	<0.005
4000	-7.4	>5000	<0.005
4500	-8.6	OPEN	<0.005



POWER COEFFICIENT OF RESISTANCE (PCR)

In precision resistors with low TCR, the self heating (Joule effect) causes the resistor not to perform strictly to its TCR specifications. This inaccuracy will result in an error at the end in the resistance value under applied power. Vishay Foil Resistors introduced a new concept of Power Coefficient of Resistance (PCR) along with a new Z-Foil technology which leads to reduction of the sensitivity of precision resistor to ambient temperature variations and changes of applied power.

Figure 9 represents PCR behavior of three different resistor technologies under applied power.

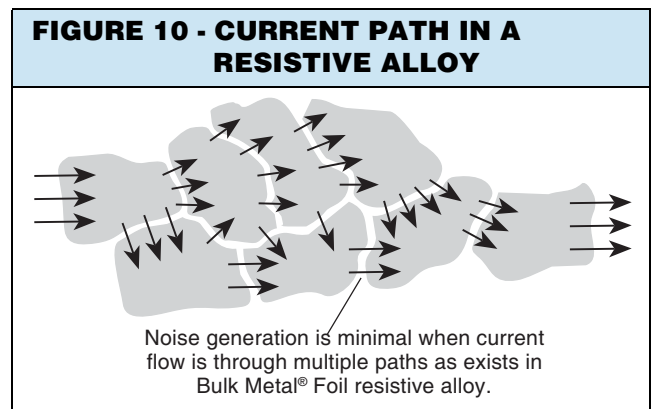
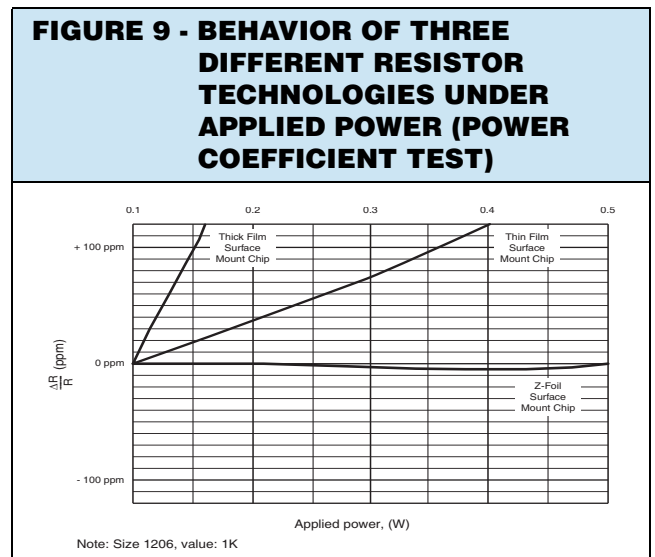

POST MANUFACTURE OPERATIONS (PMO)

What is the importance of resistor stability in an electronic circuit?

Answer: The circuit was probably not intended for just a onetime use. Also, the equipment may have to endure some environmental and operational stresses. So, the ongoing use of the equipment is expected and the more stable the resistors, the longer the time before recalibrations. FRSM offers the most stability in all categories but there is more than recalibration at stake here: extremes of surge voltage can cause thin film resistors to go open while the Foil resistor based on the Z1 technology is not affected. An open means the equipment must be returned to the maintenance department to have the resistor replaced or, worse yet, mission failure. The cost of a Foil resistor would have been insignificant compared to the cost of mission failure or the cost of returning an instrument for repair or replacement of a blown resistor. Add to this the down time of the equipment.

the end of that period, and in spite of permissible service conditions, the equipment is expected to still be functional in its intended service and within its accuracy limits. All the components contribute in some way to the stability of the equipment but the resistors are the devices relied upon most to retain the original accuracy of the equipment. Any departure from the end-of-life accuracy limits set for one resistor renders the entire equipment "out of service" and subject to repair or recalibration. The prospect of repair or recalibration is unthinkable in certain applications (space for example) and only devices that can be given an appropriate initial tolerance with the expectation of retaining proximity to the initial value throughout the service life are suitable. This is especially true of the resistors in a circuit which may have power applied causing self heating, load applied for extended periods or load life and load applied differentially from other resistors resulting in a ratio offset. The equipment itself may see elevated temperatures for extended periods of storage. Foil resistors are the best solution when these factors come into play.

Designing for extended service - All electronic equipment is expected to do something useful for a specified period of time. At

TABLE 7 - GLOBAL PART NUMBER INFORMATION (1)

NEW GLOBAL PART NUMBER: Y402412K7560T9R (preferred part number format)														
DENOTES PRECISION Y			VALUE R = Ω K = $k\Omega$						CHARACTERISTICS 0 = standard 9 = lead (Pb)-free 1 to 999 = custom					
Y	4	0	2	4	1	2	K	7	5	6	0	T	9	R
PRODUCT CODE 4020 = FRSM0402 ⁽²⁾ 4021 = FRSM0603 4022 = FRSM0805 4023 = FRSM1206 4024 = FRSM1506 4025 = FRSM2010 4027 = FRSM2512					RESISTANCE TOLERANCE T = $\pm 0.01\%$ Q = $\pm 0.02\%$ A = $\pm 0.05\%$ B = $\pm 0.10\%$ C = $\pm 0.25\%$ D = $\pm 0.5\%$ F = $\pm 1.0\%$				PACKAGING R = tape and reel W = waffle pack					
FOR EXAMPLE: ABOVE GLOBAL ORDER Y4024 12K7560 T 9 R:														
TYPE: FRSM1506														
VALUES: 12.7560 $k\Omega$														
ABSOLUTE TOLERANCE: 0.01 %														
TERMINATION: lead (Pb)-free														
PACKAGING: tape and reel														
HISTORICAL PART NUMBER: FRSM1506 12K756 TCR0.2 T S T (will continue to be used)														
FRSM1506			12K756			TCR0.2			T		S		T	
MODEL			RESISTANCE VALUE			TCR CHARACTERISTICS			TOLERANCE		TERMINATION		PACKAGING	
FRSM0402 ⁽²⁾ FRSM0603 FRSM0805 FRSM1206 FRSM1506 FRSM2010 FRSM2512			12.756 $k\Omega$						T = $\pm 0.01\%$ Q = $\pm 0.02\%$ A = $\pm 0.05\%$ B = $\pm 0.10\%$ C = $\pm 0.25\%$ D = $\pm 0.5\%$ F = $\pm 1.0\%$		S = lead (Pb)-free B = tin/lead		T = tape and reel W = waffle pack	

Note

(1) For non-standard requests, please contact application engineering.

(2) 0402 is planned to be released to production at 2012.



Disclaimer

ALL PRODUCTS, PRODUCT SPECIFICATIONS AND DATA ARE SUBJECT TO CHANGE WITHOUT NOTICE.

Vishay Precision Group, Inc., its affiliates, agents, and employees, and all persons acting on its or their behalf (collectively, "VPG"), disclaim any and all liability for any errors, inaccuracies or incompleteness contained herein or in any other disclosure relating to any product.

The product specifications do not expand or otherwise modify VPG's terms and conditions of purchase, including but not limited to, the warranty expressed therein.

VPG makes no warranty, representation or guarantee other than as set forth in the terms and conditions of purchase. **To the maximum extent permitted by applicable law, VPG disclaims (i) any and all liability arising out of the application or use of any product, (ii) any and all liability, including without limitation special, consequential or incidental damages, and (iii) any and all implied warranties, including warranties of fitness for particular purpose, non-infringement and merchantability.**

Information provided in datasheets and/or specifications may vary from actual results in different applications and performance may vary over time. Statements regarding the suitability of products for certain types of applications are based on VPG's knowledge of typical requirements that are often placed on VPG products. It is the customer's responsibility to validate that a particular product with the properties described in the product specification is suitable for use in a particular application. You should ensure you have the current version of the relevant information by contacting VPG prior to performing installation or use of the product, such as on our website at vpgsensors.com.

No license, express, implied, or otherwise, to any intellectual property rights is granted by this document, or by any conduct of VPG.

The products shown herein are not designed for use in life-saving or life-sustaining applications unless otherwise expressly indicated. Customers using or selling VPG products not expressly indicated for use in such applications do so entirely at their own risk and agree to fully indemnify VPG for any damages arising or resulting from such use or sale. Please contact authorized VPG personnel to obtain written terms and conditions regarding products designed for such applications.

Product names and markings noted herein may be trademarks of their respective owners.

Copyright Vishay Precision Group, Inc., 2014. All rights reserved.

Компания «Океан Электроники» предлагает заключение долгосрочных отношений при поставках импортных электронных компонентов на взаимовыгодных условиях!

Наши преимущества:

- Поставка оригинальных импортных электронных компонентов напрямую с производств Америки, Европы и Азии, а так же с крупнейших складов мира;
- Широкая линейка поставок активных и пассивных импортных электронных компонентов (более 30 млн. наименований);
- Поставка сложных, дефицитных, либо снятых с производства позиций;
- Оперативные сроки поставки под заказ (от 5 рабочих дней);
- Экспресс доставка в любую точку России;
- Помощь Конструкторского Отдела и консультации квалифицированных инженеров;
- Техническая поддержка проекта, помощь в подборе аналогов, поставка прототипов;
- Поставка электронных компонентов под контролем ВП;
- Система менеджмента качества сертифицирована по Международному стандарту ISO 9001;
- При необходимости вся продукция военного и аэрокосмического назначения проходит испытания и сертификацию в лаборатории (по согласованию с заказчиком);
- Поставка специализированных компонентов военного и аэрокосмического уровня качества (Xilinx, Altera, Analog Devices, Intersil, Interpoint, Microsemi, Actel, Aeroflex, Peregrine, VPT, Syfer, Eurofarad, Texas Instruments, MS Kennedy, Miteq, Cobham, E2V, MA-COM, Hittite, Mini-Circuits, General Dynamics и др.);

Компания «Океан Электроники» является официальным дистрибьютором и эксклюзивным представителем в России одного из крупнейших производителей разъемов военного и аэрокосмического назначения «JONHON», а так же официальным дистрибьютором и эксклюзивным представителем в России производителя высокотехнологичных и надежных решений для передачи СВЧ сигналов «FORSTAR».



JONHON

«JONHON» (основан в 1970 г.)

Разъемы специального, военного и аэрокосмического назначения:

(Применяются в военной, авиационной, аэрокосмической, морской, железнодорожной, горно- и нефтедобывающей отраслях промышленности)

«FORSTAR» (основан в 1998 г.)

ВЧ соединители, коаксиальные кабели, кабельные сборки и микроволновые компоненты:

(Применяются в телекоммуникациях гражданского и специального назначения, в средствах связи, РЛС, а так же военной, авиационной и аэрокосмической отраслях промышленности).



Телефон: 8 (812) 309-75-97 (многоканальный)

Факс: 8 (812) 320-03-32

Электронная почта: ocean@oceanchips.ru

Web: <http://oceanchips.ru/>

Адрес: 198099, г. Санкт-Петербург, ул. Калинина, д. 2, корп. 4, лит. А