

## 4K I<sup>2</sup>C Serial EEPROM with Half-Array Write-Protect

### Device Selection Table

Part Number	V <sub>cc</sub> Range	Max. Clock Frequency	Temp. Ranges	Available Packages
24AA04H	1.7V-5.5V	400 kHz <sup>(1)</sup>	I	MNY, P, MS, SN, ST, OT
24LC04BH	2.5-V5.5V	400 kHz	I, E	MNY, P, MS, SN, ST, OT
24FC04H	1.7V-5.5V	1 MHz	I, E	MUY, P, MS, SN, ST, OT

**Note 1:** 100 kHz for V<sub>cc</sub> < 2.5V

### Features

- Single Supply with Operation Down to 1.7V for 24AA04H and 24FC04H Devices, 2.5V for 24LC04BH Devices
- Low-Power CMOS Technology:
  - Read current 1 mA, maximum
  - Standby current 1 μA, maximum (I-temp.)
- 2-Wire Serial Interface, I<sup>2</sup>C Compatible
- Schmitt Trigger Inputs for Noise Suppression
- Output Slope Control to Eliminate Ground Bounce
- 100 kHz, 400 kHz and 1 MHz Clock Compatibility
- Page Write Time 5 ms, Maximum
- Self-Timed Erase/Write Cycle
- 16-Byte Page Write Buffer
- Hardware Write-Protect for Half-Array (100h-1FFh)
- ESD Protection >4,000V
- More than 1 Million Erase/Write Cycles
- Data Retention >200 years
- Factory Programming Available
- RoHS Compliant
- Temperature Ranges:
  - Industrial (I): -40°C to +85°C
  - Extended (E): -40°C to +125°C
- Automotive AEC-Q100 Qualified

### Packages

- 8-Lead MSOP, 8-Lead PDIP, 8-Lead SOIC, 8-Lead TDFN, 8-Lead TSSOP, 8-Lead UDFN and 5-Lead SOT-23

### Description

The Microchip Technology Inc. 24XX04H<sup>(1)</sup> is a 4 Kbit Electrically Erasable PROM. The device is organized as two blocks of 256 x 8-bit memory with a 2-wire serial interface. Its low-voltage design permits operation down to 1.7V, with standby and active currents of only 1 μA and 1 mA, respectively. The 24XX04H also has a page write capability for up to 16 bytes of data.

**Note 1:** 24XX04H is used in this document as a generic part number for the 24AA04H/24LC04BH/24FC04H devices.

### Package Types



# 24AA04H/24LC04BH/24FC04H

## Block Diagram



# 24AA04H/24LC04BH/24FC04H

## 1.0 ELECTRICAL CHARACTERISTICS

### Absolute Maximum Ratings (†)

V <sub>CC</sub> .....	6.5V
All inputs and outputs w.r.t. V <sub>SS</sub> .....	-0.3V to V <sub>CC</sub> +1.0V
Storage temperature .....	-65°C to +150°C
Ambient temperature with power applied.....	-40°C to +125°C
ESD protection on all pins .....	≥ 4 kV

† NOTICE: Stresses above those listed under “Absolute Maximum Ratings” may cause permanent damage to the device. This is a stress rating only and functional operation of the device at those or any other conditions above those indicated in the operational listings of this specification is not implied. Exposure to maximum rating conditions for extended periods may affect device reliability.

**TABLE 1-1: DC CHARACTERISTICS**

DC CHARACTERISTICS		Industrial (I): TA = -40°C to +85°C, V <sub>CC</sub> = +1.7V to +5.5V Extended (E): TA = -40°C to +125°C, V <sub>CC</sub> = +2.5V to +5.5V (24LC04BH) Extended (E): TA = -40°C to +125°C, V <sub>CC</sub> = +1.7V to +5.5V (24FC04H)					
Param. No.	Symbol	Characteristic	Min.	Typ.	Max.	Units	Conditions
D1	V <sub>IH</sub>	High-level Input Voltage	0.7 V <sub>CC</sub>	—	—	V	
D2	V <sub>IL</sub>	Low-level Input Voltage	—	—	0.3 V <sub>CC</sub>	V	
D3	V <sub>HYS</sub>	Hysteresis of Schmitt Trigger Inputs	0.05 V <sub>CC</sub>	—	—	V	Note
D4	V <sub>OL</sub>	Low-level Output Voltage	—	—	0.40	V	I <sub>OL</sub> = 3.0 mA, V <sub>CC</sub> = 2.5V
D5	I <sub>LI</sub>	Input Leakage Current	—	—	±1	μA	V <sub>IN</sub> = V <sub>SS</sub> or V <sub>CC</sub>
D6	I <sub>LO</sub>	Output Leakage Current	—	—	±1	μA	V <sub>OUT</sub> = V <sub>SS</sub> or V <sub>CC</sub>
D7	C <sub>IN</sub> , C <sub>OUT</sub>	Pin Capacitance (all inputs/outputs)	—	—	10	pF	V <sub>CC</sub> = 5.0V (Note) TA = 25°C, F <sub>CLK</sub> = 1 MHz
D8	I <sub>CCWRITE</sub>	Operating Current	—	—	3	mA	V <sub>CC</sub> = 5.5V, SCL = 400 kHz
D9	I <sub>CCREAD</sub>		—	—	1	mA	V <sub>CC</sub> = 5.5V, SCL = 400 kHz
D10	I <sub>CCS</sub>	Standby Current	—	—	1	μA	SDA = SCL = V <sub>CC</sub> WP = V <sub>SS</sub> , I-Temp.
			—	—	3	μA	SDA = SCL = V <sub>CC</sub> WP = V <sub>SS</sub> , E-Temp. (24FC04H)
			—	—	5	μA	SDA = SCL = V <sub>CC</sub> WP = V <sub>SS</sub> , E-Temp. (24LC04BH)

**Note:** This parameter is periodically sampled and not 100% tested.

# 24AA04H/24LC04BH/24FC04H

**TABLE 1-2: AC CHARACTERISTICS**

AC CHARACTERISTICS			Industrial (I): TA = -40°C to +85°C, Vcc = +1.7V to +5.5V Extended (E): TA = -40°C to +125°C, Vcc = +2.5V to +5.5V (24LC04BH) Extended (E): TA = -40°C to +125°C, Vcc = +1.7V to +5.5V (24FC04H)			
Param. No.	Symbol	Characteristic	Min.	Max	Units	Conditions
1	FCLK	Clock Frequency	—	400	kHz	2.5V ≤ Vcc ≤ 5.5V
			—	100	kHz	1.7V ≤ Vcc < 2.5V (24AA04H)
			—	1000	kHz	1.7V ≤ VCC ≤ 5.5V (24FC04H)
2	THIGH	Clock High Time	600	—	ns	2.5V ≤ Vcc ≤ 5.5V
			4000	—	ns	1.7V ≤ Vcc < 2.5V (24AA04H)
			260	—	ns	1.7V ≤ VCC ≤ 5.5V (24FC04H)
3	TLOW	Clock Low Time	1300	—	ns	2.5V ≤ Vcc ≤ 5.5V
			4700	—	ns	1.7V ≤ Vcc < 2.5V (24AA04H)
			500	—	ns	1.7V ≤ VCC ≤ 5.5V (24FC04H)
4	TR	SDA and SCL Rise Time	—	300	ns	2.5V ≤ Vcc ≤ 5.5V (Note 1)
			—	1000	ns	1.7V ≤ Vcc < 2.5V (24AA04H) (Note 1)
			—	1000	ns	1.7V ≤ VCC ≤ 5.5V (24FC04H) (Note 1)
5	TF	SDA and SCL Fall Time	—	300	ns	Note 1
6	THD:STA	Start Condition Hold Time	600	—	ns	2.5V ≤ Vcc ≤ 5.5V
			4000	—	ns	1.7V ≤ Vcc < 2.5V (24AA04H)
			250	—	ns	1.7V ≤ VCC ≤ 5.5V (24FC04H)
7	TSU:STA	Start Condition Setup Time	600	—	ns	2.5V ≤ Vcc ≤ 5.5V
			4700	—	ns	1.7V ≤ Vcc < 2.5V (24AA04H)
			250	—	ns	1.7V ≤ VCC ≤ 5.5V (24FC04H)
8	THD:DAT	Data Input Hold Time	0	—	ns	Note 2
9	TSU:DAT	Data Input Setup Time	100	—	ns	2.5V ≤ Vcc ≤ 5.5V
			250	—	ns	1.7V ≤ Vcc < 2.5V (24AA04H)
			50	—	ns	1.7V ≤ VCC ≤ 5.5V (24FC04H)
10	TSU:STO	Stop Condition Setup Time	600	—	ns	2.5V ≤ Vcc ≤ 5.5V
			4000	—	ns	1.7V ≤ Vcc < 2.5V (24AA04H)
			250	—	ns	1.7V ≤ VCC ≤ 5.5V (24FC04H)
11	TSU:WP	WP Setup Time	600	—	ns	2.5V ≤ Vcc ≤ 5.5V
			4000	—	ns	1.7V ≤ Vcc < 2.5V (24AA04H)
			600	—	ns	1.7V ≤ VCC ≤ 5.5V (24FC04H)
12	THD:WP	WP Hold Time	1300	—	ns	2.5V ≤ Vcc ≤ 5.5V
			4700	—	ns	1.7V ≤ Vcc < 2.5V (24AA04H)
			600	—	ns	1.7V ≤ VCC ≤ 5.5V (24FC04H)

**Note 1:** Not 100% tested. CB = total capacitance of one bus line in pF.

**2:** As a transmitter the device must provide an internal minimum delay time to bridge the undefined region (minimum 300 ns) of the falling edge of SCL to avoid unintended generation of Start or Stop conditions.

**3:** CB = total capacitance of one bus line in pF.

**4:** This parameter is not tested but ensured by characterization. For endurance estimates in a specific application, please consult the Total Endurance™ Model which can be obtained on Microchip's website at [www.microchip.com](http://www.microchip.com).

# 24AA04H/24LC04BH/24FC04H

**TABLE 1-2: AC CHARACTERISTICS (CONTINUED)**

AC CHARACTERISTICS			Industrial (I): TA = -40°C to +85°C, VCC = +1.7V to +5.5V Extended (E): TA = -40°C to +125°C, VCC = +2.5V to +5.5V (24LC04BH) Extended (E): TA = -40°C to +125°C, VCC = +1.7V to +5.5V (24FC04H)			
Param. No.	Symbol	Characteristic	Min.	Max	Units	Conditions
13	TAA	Output Valid from Clock	—	900	ns	2.5V ≤ VCC ≤ 5.5V ( <b>Note 2</b> )
			—	3500	ns	1.7V ≤ VCC < 2.5V ( <b>24AA04H</b> ) ( <b>Note 2</b> )
			—	450	ns	1.7V ≤ VCC ≤ 5.5V ( <b>24FC04H</b> ) ( <b>Note 2</b> )
14	TBUF	Bus Free Time: The time the bus must be free before a new transmission can start	1300	—	ns	2.5V ≤ VCC ≤ 5.5V
			4700	—	ns	1.7V ≤ VCC < 2.5V ( <b>24AA04H</b> )
			500	—	ns	1.7V ≤ VCC ≤ 5.5V ( <b>24FC04H</b> )
15	TOF	Output Fall Time from VIH Minimum to VIL Maximum	—	250	ns	2.5V ≤ VCC ≤ 5.5V ( <b>24LC04BH</b> ) ( <b>Notes 1, 2 and 3</b> )
			—	250	ns	1.7V ≤ VCC < 2.5V ( <b>24AA04H</b> ) ( <b>Notes 1 and 2</b> )
16	TSP	Input Filter Spike Suppression (SDA and SCL pins)	—	50	ns	<b>Note 1</b>
17	TWC	Write Cycle Time (byte or page)	—	5	ms	—
18	—	Endurance	1,000,000	—	cycles	25°C, 5.5V, Page Mode ( <b>Note 4</b> )

**Note 1:** Not 100% tested. CB = total capacitance of one bus line in pF.

**2:** As a transmitter the device must provide an internal minimum delay time to bridge the undefined region (minimum 300 ns) of the falling edge of SCL to avoid unintended generation of Start or Stop conditions.

**3:** CB = total capacitance of one bus line in pF.

**4:** This parameter is not tested but ensured by characterization. For endurance estimates in a specific application, please consult the Total Endurance™ Model which can be obtained on Microchip's website at [www.microchip.com](http://www.microchip.com).

**FIGURE 1-1: BUS TIMING DATA**



# 24AA04H/24LC04BH/24FC04H

## 2.0 PIN DESCRIPTIONS

The descriptions of the pins are listed in [Table 2-1](#).

**TABLE 2-1: PIN FUNCTION TABLE**

Name	PDIP	SOIC	TSSOP	TDFN	MSOP	UDFN	SOT-23	Description
A0	1	1	1	1	1	1	—	Not Connected
A1	2	2	2	2	2	2	—	Not Connected
A2	3	3	3	3	3	3	—	Not Connected
Vss	4	4	4	4	4	4	2	Ground
SDA	5	5	5	5	5	5	3	Serial Address/Data I/O
SCL	6	6	6	6	6	6	1	Serial Clock
WP	7	7	7	7	7	7	5	Write-Protect Input
Vcc	8	8	8	8	8	8	4	Power Supply

**Note:** The exposed pad on the UDFN/TDFN package can be connected to Vss or left floating.

### 2.1 A0, A1, A2

The A0, A1 and A2 pins are not used by the 24XX04H. They may be left floating or tied to either Vss or Vcc.

### 2.2 Serial Address/Data Input/Output (SDA)

The SDA input is a bidirectional pin used to transfer addresses and data into and out of the device. Since it is an open-drain terminal, the SDA bus requires a pull-up resistor to Vcc (typical 10 k $\Omega$  for 100 kHz, 2 k $\Omega$  for 400 kHz and 1 MHz).

For normal data transfer, SDA is allowed to change only during SCL low. Changes during SCL high are reserved for indicating Start and Stop conditions.

### 2.3 Serial Clock (SCL)

The SCL input is used to synchronize the data transfer to and from the device.

### 2.4 Write-Protect (WP)

This pin must be connected to either Vss or Vcc.

If tied to Vss, normal memory operation is enabled (read/write the entire memory 000h-1FFh).

If tied to Vcc, write operations are inhibited. Half of the memory will be write-protected (100h-1FFh). Read operations are not affected.

## 3.0 FUNCTIONAL DESCRIPTION

The 24XX04H supports a bidirectional, 2-wire bus and data transmission protocol. A device that sends data onto the bus is defined as a transmitter, while a device receiving data is defined as a receiver. The bus has to be controlled by a master device which generates the Serial Clock (SCL), controls the bus access and generates the Start and Stop conditions, while the 24XX04H works as slave. Both master and slave can operate as transmitter or receiver, but the master device determines which mode is activated.

## 4.0 BUS CHARACTERISTICS

The following **bus protocol** has been defined:

- Data transfer may be initiated only when the bus is not busy.
- During data transfer, the data line must remain stable whenever the clock line is high. Changes in the data line while the clock line is high will be interpreted as a Start or Stop condition.

Accordingly, the following bus conditions have been defined (Figure 4-1).

### 4.1 Bus Not Busy (A)

Both data and clock lines remain high.

### 4.2 Start Data Transfer (B)

A high-to-low transition of the SDA line while the clock (SCL) is high determines a Start condition. All commands must be preceded by a Start condition.

### 4.3 Stop Data Transfer (C)

A low-to-high transition of the SDA line while the clock (SCL) is high determines a Stop condition. All operations must be ended with a Stop condition.

### 4.4 Data Valid (D)

The state of the data line represents valid data when, after a Start condition, the data line is stable for the duration of the high period of the clock signal.

The data on the line must be changed during the low period of the clock signal. There is one clock pulse per bit of data.

Each data transfer is initiated with a Start condition and terminated with a Stop condition. The number of the data bytes transferred between the Start and Stop conditions is determined by the master device and is, theoretically, unlimited (although only the last sixteen will be stored when doing a write operation). When an overwrite does occur it will replace data in a first-in first-out (FIFO) principle.

### 4.5 Acknowledge

Each receiving device, when addressed, is obliged to generate an acknowledge after the reception of each byte. The master device must generate an extra clock pulse which is associated with this Acknowledge bit.

**Note:** The 24XX04H does not generate any Acknowledge bits if an internal programming cycle is in progress.

The device that acknowledges has to pull down the SDA line during the acknowledge clock pulse in such a way that the SDA line is stable-low during the high period of the acknowledge-related clock pulse. Moreover, setup and hold times must be taken into account. During reads, a master must signal an end of data to the slave by not generating an Acknowledge bit on the last byte that has been clocked out of the slave. In this case, the slave (24XX04H) will leave the data line high to enable the master to generate the Stop condition.

**FIGURE 4-1: DATA TRANSFER SEQUENCE ON THE SERIAL BUS**



# 24AA04H/24LC04BH/24FC04H

## 5.0 DEVICE ADDRESSING

A control byte is the first byte received following the Start condition from the master device. The control byte consists of a four-bit control code. For the 24XX04H, this is set as '1010' binary for read and write operations. The next two bits of the control byte are "don't cares" for the 24XX04H. The last bit, B0, is used by the master device to select which of the two 256-word blocks of memory are to be accessed. This bit is, in effect, the Most Significant bit of the word address. The combination of the 4-bit control code and the next three bits are called the slave address.

The last bit of the control byte is the Read/Write (R/W) bit and it defines the operation to be performed. When set to '1', a read operation is selected. When set to '0', a write operation is selected. Following the Start condition, the 24XX04H monitors the SDA bus, checking the device type identifier being transmitted. Upon receiving a valid slave address and the R/W bit, the slave device outputs an Acknowledge signal on the SDA line. Depending on the state of the R/W bit, the 24XX04H will select a read or write operation.

The next byte received defines the address of the first data byte within the selected block (Figure 5-2). The word address byte uses all eight bits.

Operation	Control Code	Block Select	R/W
Read	1010	Block Address	1
Write	1010	Block Address	0

**FIGURE 5-1: CONTROL BYTE ALLOCATION**



**FIGURE 5-2: ADDRESS SEQUENCE BIT ASSIGNMENTS**





# 24AA04H/24LC04BH/24FC04H

## 6.0 WRITE OPERATION

### 6.1 Byte Write

Following the Start condition from the master, the device code (4 bits), the block address (2 bits, “don’t care”, plus B0 bit) and the  $R/\overline{W}$  bit, which is a logic-low, is placed onto the bus by the master transmitter. This indicates to the addressed slave receiver that a byte with a word address will follow after it has generated an Acknowledge bit during the ninth clock cycle. Therefore, the next byte transmitted by the master is the word address and will be written into the Address Pointer of the 24XX04H. After receiving another Acknowledge signal from the 24XX04H, the master device will transmit the data word to be written into the addressed memory location. The 24XX04H acknowledges again and the master generates a Stop condition. This initiates the internal write cycle, and, during this time, the 24XX04H will not generate Acknowledge signals (Figure 6-1).

### 6.2 Page Write

The write control byte, word address and the first data byte are transmitted to the 24XX04H in the same way as in a byte write. However, instead of generating a Stop condition, the master transmits up to 16 data bytes to the 24XX04H, which are temporarily stored in the on-chip page buffer and will be written into memory once the master has transmitted a Stop condition. Upon receipt of each word, the four lower-order Address Pointer bits, which form the byte counter, are internally incremented by one. The higher-order four bits of the word address and bit B0 remain constant. If the master should transmit more than 16 words prior to generating the Stop condition, the address counter will roll over and the previously received data will be overwritten. As with the byte write operation, once the Stop condition is received an internal write cycle will begin (Figure 6-2).

**Note:** Page write operations are limited to writing bytes within a single physical page, regardless of the number of bytes actually being written. Physical page boundaries start at addresses that are integer multiples of the page buffer size (or ‘page-size’) and end at addresses that are integer multiples of page size – 1. If a page write command attempts to write across a physical page boundary, the result is that the data wraps around to the beginning of the current page (overwriting data previously stored there), instead of being written to the next page, as might be expected. It is therefore necessary for the application software to prevent page write operations that would attempt to cross a page boundary.

### 6.3 Write Protection

The WP pin allows the user to write-protect half of the array (100h-1FFh) when the pin is tied to Vcc. If the pin is tied to Vss, the write protection is disabled.

FIGURE 6-1: BYTE WRITE



# 24AA04H/24LC04BH/24FC04H

FIGURE 6-2: PAGE WRITE



## 7.0 ACKNOWLEDGE POLLING

Since the device will not acknowledge during a write cycle, this can be used to determine when the cycle is complete (this feature can be used to maximize bus throughput). Once the Stop condition for a write command has been issued from the master, the device initiates the internally-timed write cycle. ACK polling can then be initiated immediately. This involves the master sending a Start condition followed by the control byte for a write command ( $R/\overline{W} = 0$ ). If the device is still busy with the write cycle, no ACK will be returned. If the cycle is complete, the device will return the ACK and the master can then proceed with the next read or write operation. See [Figure 7-1](#) for a flow diagram of this operation.

**FIGURE 7-1: ACKNOWLEDGE POLLING FLOW**



# 24AA04H/24LC04BH/24FC04H

## 8.0 READ OPERATION

Read operations are initiated in the same way as write operations, with the exception that the R/W bit of the slave address is set to '1'. There are three basic types of read operations: current address read, random read and sequential read.

### 8.1 Current Address Read

The 24XX04H contains an address counter that maintains the address of the last word accessed, internally incremented by one. Therefore, if the previous access (either a read or write operation) was to address  $n$ , the next current address read operation would access data from address  $n + 1$ . Upon receipt of the slave address with R/W bit set to '1', the 24XX04H issues an acknowledge and transmits the 8-bit data word. The master will not acknowledge the transfer, but does generate a Stop condition and the 24XX04H discontinues transmission (Figure 8-1).

### 8.2 Random Read

Random read operations allow the master to access any memory location in a random manner. To perform this type of read operation, the word address must first be set. This is accomplished by sending the word address to the 24XX04H as part of a write operation. Once the word address is sent, the master generates a Start condition following the acknowledge. This terminates the write operation, but not before the internal Address Pointer is set. The master then issues the control byte again, but with the R/W bit set to a '1'. The 24XX04H will then issue an acknowledge and transmits the 8-bit data word. The master will not acknowledge the transfer, but does generate a Stop condition and the 24XX04H will discontinue transmission (Figure 8-2).

### 8.3 Sequential Read

Sequential reads are initiated in the same way as a random read, except that once the 24XX04H transmits the first data byte, the master issues an acknowledge (as opposed to a Stop condition in a random read). This directs the 24XX04H to transmit the next sequentially addressed 8-bit word (Figure 8-3).

To provide sequential reads, the 24XX04H contains an internal Address Pointer that is incremented by one at the completion of each operation. This Address Pointer allows the entire memory contents to be serially read during one operation.

### 8.4 Noise Protection

The SCL and SDA inputs have Schmitt Trigger and filter circuits which suppress noise spikes to assure proper device operation even on a noisy bus.

FIGURE 8-1: CURRENT ADDRESS READ



# 24AA04H/24LC04BH/24FC04H

**FIGURE 8-2: RANDOM READ**



**FIGURE 8-3: SEQUENTIAL READ**



# 24AA04H/24LC04BH/24FC04H

## 9.0 PACKAGING INFORMATION

### 9.1 Package Marking Information

8-Lead PDIP (300 mil)

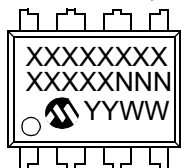

Example

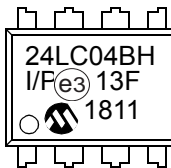

8-Lead SOIC (3.90 mm)

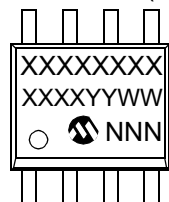

Example

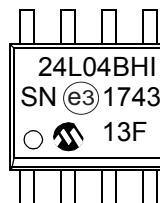

8-Lead TSSOP



Example

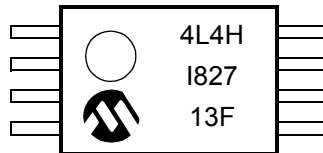

8-Lead MSOP

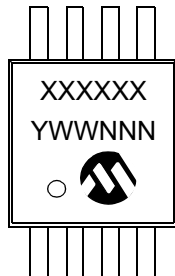

Example

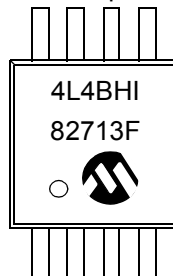

5-Lead SOT-23 (1-Line Marking)

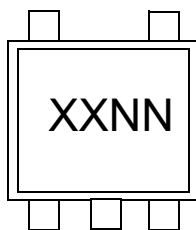

Example

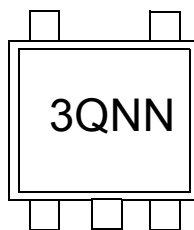

5-Lead SOT-23 (2-Line Marking)

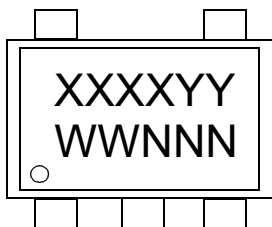

Example

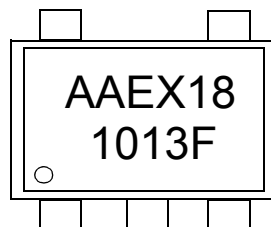

# 24AA04H/24LC04BH/24FC04H

8-Lead 2x3 TDFN



Example



8-Lead 2x3 UDFN



Example



1st Line Marking									
Part No.	TSSOP	MSOP	PDIP	SOIC	UDFN	SOT-23		TDFN	
						I-Temp	E-Temp	I-Temp	E-Temp
24AA04H	4A4H	4A4HT <sup>(1)</sup>	24AA04H	24AA04HT <sup>(1)</sup>	—	3MNN <sup>(2, 3)</sup>	—	AE1	—
24LC04BH	4L4H	4L4BHT <sup>(1)</sup>	24LC04BH	24LC04BHT <sup>(1)</sup>	—	3QNN <sup>(2, 3)</sup>	3RNN <sup>(2, 3)</sup>	AE4	AE5
24FC04H	AADV	4FC04H	24FC04H	24FC04H	ADQ	AAEXYY <sup>(4)</sup>	AAEXYY <sup>(4)</sup>	—	—

- Note 1:** T = Temperature grade (I, E)  
**2:** NN = Alphanumeric traceability code  
**3:** These parts use the 1-line SOT-23 marking format  
**4:** These parts use the 2-line SOT-23 marking format

<b>Legend:</b>	XX...X	Part number or part number code
	T	Temperature (I, E)
	Y	Year code (last digit of calendar year)
	YY	Year code (last 2 digits of calendar year)
	WW	Week code (week of January 1 is week '01')
	NNN	Alphanumeric traceability code (2 characters for small packages)
	e3	JEDEC <sup>®</sup> designator for Matte Tin (Sn)
* Standard OTP marking consists of Microchip part number, year code, week code, and traceability code.		
<b>Note:</b>	For very small packages with no room for the JEDEC <sup>®</sup> designator e3, the marking will only appear on the outer carton or reel label	
<b>Note:</b>	In the event the full Microchip part number cannot be marked on one line, it will be carried over to the next line, thus limiting the number of available characters for customer-specific information.	

# 24AA04H/24LC04BH/24FC04H

## 8-Lead Plastic Dual In-Line (P) - 300 mil Body [PDIP]

**Note:** For the most current package drawings, please see the Microchip Packaging Specification located at <http://www.microchip.com/packaging>

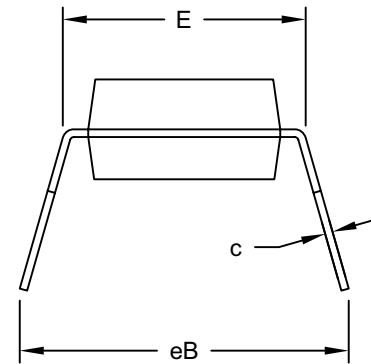
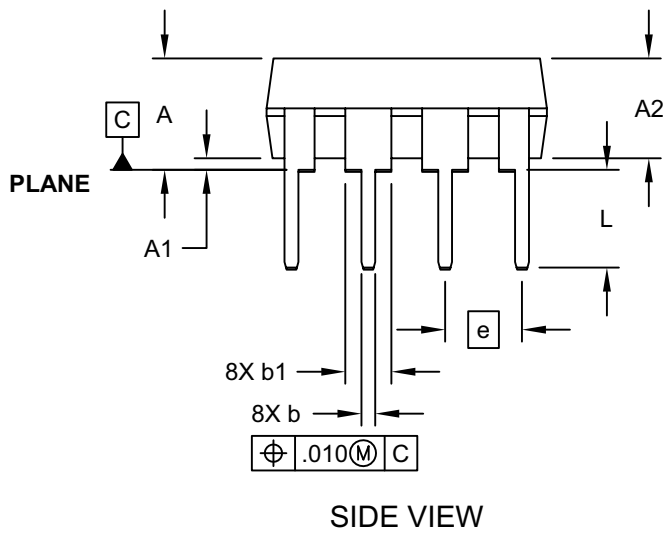
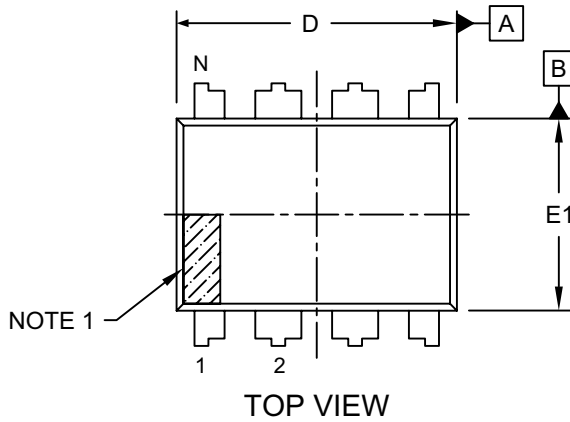

Microchip Technology Drawing No. C04-018D Sheet 1 of 2



# 24AA04H/24LC04BH/24FC04H

## 8-Lead Plastic Dual In-Line (P) - 300 mil Body [PDIP]

**Note:** For the most current package drawings, please see the Microchip Packaging Specification located at <http://www.microchip.com/packaging>



		Units	INCHES		
Dimension Limits			MIN	NOM	MAX
Number of Pins	N		8		
Pitch	e		.100 BSC		
Top to Seating Plane	A	-	-	-	.210
Molded Package Thickness	A2	.115	.130	.130	.195
Base to Seating Plane	A1	.015	-	-	-
Shoulder to Shoulder Width	E	.290	.310	.310	.325
Molded Package Width	E1	.240	.250	.250	.280
Overall Length	D	.348	.365	.365	.400
Tip to Seating Plane	L	.115	.130	.130	.150
Lead Thickness	c	.008	.010	.010	.015
Upper Lead Width	b1	.040	.060	.060	.070
Lower Lead Width	b	.014	.018	.018	.022
Overall Row Spacing	§	eB	-	-	.430

**Notes:**

- Pin 1 visual index feature may vary, but must be located within the hatched area.
- § Significant Characteristic
- Dimensions D and E1 do not include mold flash or protrusions. Mold flash or protrusions shall not exceed .010" per side.
- Dimensioning and tolerancing per ASME Y14.5M  
BSC: Basic Dimension. Theoretically exact value shown without tolerances.

Microchip Technology Drawing No. C04-018D Sheet 2 of 2

# 24AA04H/24LC04BH/24FC04H

## 8-Lead Plastic Small Outline (SN) - Narrow, 3.90 mm (.150 In.) Body [SOIC]

**Note:** For the most current package drawings, please see the Microchip Packaging Specification located at <http://www.microchip.com/packaging>



Microchip Technology Drawing No. C04-057-SN Rev D Sheet 1 of 2

# 24AA04H/24LC04BH/24FC04H

## 8-Lead Plastic Small Outline (SN) - Narrow, 3.90 mm (.150 In.) Body [SOIC]

**Note:** For the most current package drawings, please see the Microchip Packaging Specification located at <http://www.microchip.com/packaging>



Dimension Limits	Units	MILLIMETERS		
		MIN	NOM	MAX
Number of Pins	N	8		
Pitch	e	1.27 BSC		
Overall Height	A	-	-	1.75
Molded Package Thickness	A2	1.25	-	-
Standoff §	A1	0.10	-	0.25
Overall Width	E	6.00 BSC		
Molded Package Width	E1	3.90 BSC		
Overall Length	D	4.90 BSC		
Chamfer (Optional)	h	0.25	-	0.50
Foot Length	L	0.40	-	1.27
Footprint	L1	1.04 REF		
Foot Angle	$\varphi$	0°	-	8°
Lead Thickness	c	0.17	-	0.25
Lead Width	b	0.31	-	0.51
Mold Draft Angle Top	$\alpha$	5°	-	15°
Mold Draft Angle Bottom	$\beta$	5°	-	15°

**Notes:**

1. Pin 1 visual index feature may vary, but must be located within the hatched area.
2. § Significant Characteristic
3. Dimensions D and E1 do not include mold flash or protrusions. Mold flash or protrusions shall not exceed 0.15mm per side.
4. Dimensioning and tolerancing per ASME Y14.5M  
BSC: Basic Dimension. Theoretically exact value shown without tolerances.  
REF: Reference Dimension, usually without tolerance, for information purposes only.
5. Datums A & B to be determined at Datum H.

Microchip Technology Drawing No. C04-057-SN Rev D Sheet 2 of 2

# 24AA04H/24LC04BH/24FC04H

## 8-Lead Plastic Small Outline (SN) - Narrow, 3.90 mm Body [SOIC]

**Note:** For the most current package drawings, please see the Microchip Packaging Specification located at <http://www.microchip.com/packageing>



RECOMMENDED LAND PATTERN

Dimension Limits	Units	MILLIMETERS		
		MIN	NOM	MAX
Contact Pitch	E	1.27 BSC		
Contact Pad Spacing	C		5.40	
Contact Pad Width (X8)	X1			0.60
Contact Pad Length (X8)	Y1			1.55

Notes:

1. Dimensioning and tolerancing per ASME Y14.5M  
BSC: Basic Dimension. Theoretically exact value shown without tolerances.

Microchip Technology Drawing C04-2057-SN Rev B

# 24AA04H/24LC04BH/24FC04H

## 8-Lead Plastic Thin Shrink Small Outline (ST) – 4.4 mm Body [TSSOP]

**Note:** For the most current package drawings, please see the Microchip Packaging Specification located at <http://www.microchip.com/packaging>



Dimension Limits	Units	MILLIMETERS		
		MIN	NOM	MAX
Number of Pins	N	8		
Pitch	e	0.65 BSC		
Overall Height	A	–	–	1.20
Molded Package Thickness	A2	0.80	1.00	1.05
Standoff	A1	0.05	–	0.15
Overall Width	E	6.40 BSC		
Molded Package Width	E1	4.30	4.40	4.50
Molded Package Length	D	2.90	3.00	3.10
Foot Length	L	0.45	0.60	0.75
Footprint	L1	1.00 REF		
Foot Angle	$\phi$	0°	–	8°
Lead Thickness	c	0.09	–	0.20
Lead Width	b	0.19	–	0.30

**Notes:**

- Pin 1 visual index feature may vary, but must be located within the hatched area.
- Dimensions D and E1 do not include mold flash or protrusions. Mold flash or protrusions shall not exceed 0.15 mm per side.
- Dimensioning and tolerancing per ASME Y14.5M.

BSC: Basic Dimension. Theoretically exact value shown without tolerances.

REF: Reference Dimension, usually without tolerance, for information purposes only.

Microchip Technology Drawing C04-086B

# 24AA04H/24LC04BH/24FC04H

8-Lead Plastic Thin Shrink Small Outline (ST) - 4.4 mm Body [TSSOP]

**Note:** For the most current package drawings, please see the Microchip Packaging Specification located at <http://www.microchip.com/packaging>



## RECOMMENDED LAND PATTERN

Units		MILLIMETERS		
Dimension Limits		MIN	NOM	MAX
Contact Pitch	E	0.65 BSC		
Contact Pad Spacing	C1		5.90	
Contact Pad Width (X8)	X1			0.45
Contact Pad Length (X8)	Y1			1.45
Distance Between Pads	G	0.20		

**Notes:**

1. Dimensioning and tolerancing per ASME Y14.5M

BSC: Basic Dimension. Theoretically exact value shown without tolerances.

Microchip Technology Drawing No. C04-2086A

# 24AA04H/24LC04BH/24FC04H

## 8-Lead Plastic Micro Small Outline Package (MS) [MSOP]

**Note:** For the most current package drawings, please see the Microchip Packaging Specification located at <http://www.microchip.com/packaging>



Microchip Technology Drawing C04-111C Sheet 1 of 2

# 24AA04H/24LC04BH/24FC04H

## 8-Lead Plastic Micro Small Outline Package (MS) [MSOP]

**Note:** For the most current package drawings, please see the Microchip Packaging Specification located at <http://www.microchip.com/packaging>



Dimension Limits	Units	MILLIMETERS		
		MIN	NOM	MAX
Number of Pins	N		8	
Pitch	e	0.65 BSC		
Overall Height	A	-	-	1.10
Molded Package Thickness	A2	0.75	0.85	0.95
Standoff	A1	0.00	-	0.15
Overall Width	E	4.90 BSC		
Molded Package Width	E1	3.00 BSC		
Overall Length	D	3.00 BSC		
Foot Length	L	0.40	0.60	0.80
Footprint	L1	0.95 REF		
Foot Angle	$\phi$	0°	-	8°
Lead Thickness	c	0.08	-	0.23
Lead Width	b	0.22	-	0.40

**Notes:**

- Pin 1 visual index feature may vary, but must be located within the hatched area.
- Dimensions D and E1 do not include mold flash or protrusions. Mold flash or protrusions shall not exceed 0.15mm per side.
- Dimensioning and tolerancing per ASME Y14.5M.  
 BSC: Basic Dimension. Theoretically exact value shown without tolerances.  
 REF: Reference Dimension, usually without tolerance, for information purposes only.

Microchip Technology Drawing C04-111C Sheet 2 of 2



# 24AA04H/24LC04BH/24FC04H

## 8-Lead Plastic Micro Small Outline Package (MS) [MSOP]

**Note:** For the most current package drawings, please see the Microchip Packaging Specification located at <http://www.microchip.com/packaging>



RECOMMENDED LAND PATTERN

Dimension Limits	Units	MILLIMETERS		
		MIN	NOM	MAX
Contact Pitch	E	0.65 BSC		
Contact Pad Spacing	C		4.40	
Overall Width	Z			5.85
Contact Pad Width (X8)	X1			0.45
Contact Pad Length (X8)	Y1			1.45
Distance Between Pads	G1	2.95		
Distance Between Pads	GX	0.20		

Notes:

1. Dimensioning and tolerancing per ASME Y14.5M

BSC: Basic Dimension. Theoretically exact value shown without tolerances.

Microchip Technology Drawing No. C04-2111A

# 24AA04H/24LC04BH/24FC04H

## 5-Lead Plastic Small Outline Transistor (OT) [SOT23]

**Note:** For the most current package drawings, please see the Microchip Packaging Specification located at <http://www.microchip.com/packaging>

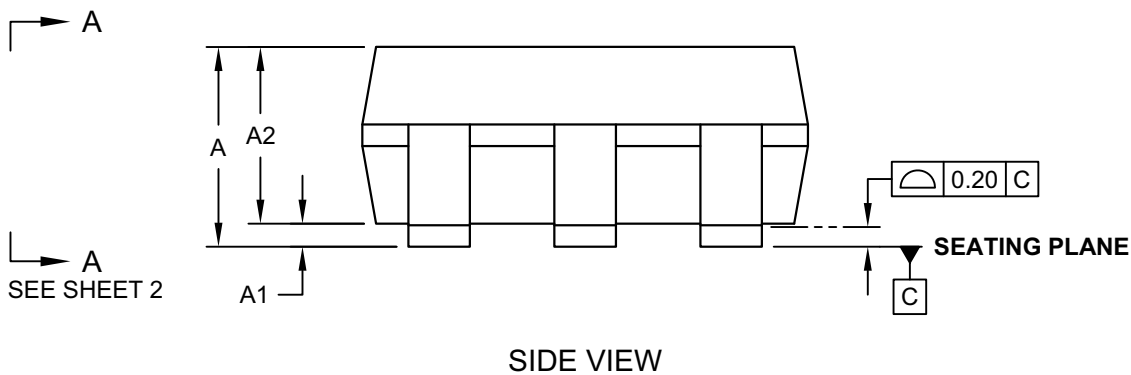

Microchip Technology Drawing C04-091-OT Rev E Sheet 1 of 2

# 24AA04H/24LC04BH/24FC04H

## 5-Lead Plastic Small Outline Transistor (OT) [SOT23]

**Note:** For the most current package drawings, please see the Microchip Packaging Specification located at <http://www.microchip.com/packaging>



VIEW A-A  
SHEET 1

Dimension Limits	Units	MILLIMETERS		
		MIN	NOM	MAX
Number of Pins	N	5		
Pitch	e	0.95 BSC		
Outside lead pitch	e1	1.90 BSC		
Overall Height	A	0.90	-	1.45
Molded Package Thickness	A2	0.89	-	1.30
Standoff	A1	-	-	0.15
Overall Width	E	2.80 BSC		
Molded Package Width	E1	1.60 BSC		
Overall Length	D	2.90 BSC		
Foot Length	L	0.30	-	0.60
Footprint	L1	0.60 REF		
Foot Angle	$\phi$	0°	-	10°
Lead Thickness	c	0.08	-	0.26
Lead Width	b	0.20	-	0.51

**Notes:**

- Dimensions D and E1 do not include mold flash or protrusions. Mold flash or protrusions shall not exceed 0.25mm per side.
- Dimensioning and tolerancing per ASME Y14.5M  
BSC: Basic Dimension. Theoretically exact value shown without tolerances.  
REF: Reference Dimension, usually without tolerance, for information purposes only.

Microchip Technology Drawing C04-091-OT Rev E Sheet 2 of 2

# 24AA04H/24LC04BH/24FC04H

## 5-Lead Plastic Small Outline Transistor (OT) [SOT23]

**Note:** For the most current package drawings, please see the Microchip Packaging Specification located at <http://www.microchip.com/packaging>



RECOMMENDED LAND PATTERN

Dimension Limits	Units	MILLIMETERS		
		MIN	NOM	MAX
Contact Pitch	E	0.95 BSC		
Contact Pad Spacing	C		2.80	
Contact Pad Width (X5)	X			0.60
Contact Pad Length (X5)	Y			1.10
Distance Between Pads	G	1.70		
Distance Between Pads	GX	0.35		
Overall Width	Z			3.90

**Notes:**

1. Dimensioning and tolerancing per ASME Y14.5M

BSC: Basic Dimension. Theoretically exact value shown without tolerances.

Microchip Technology Drawing No. C04-2091B [OT]

# 24AA04H/24LC04BH/24FC04H

## 8-Lead Plastic Dual Flat, No Lead Package (MN) – 2x3x0.8 mm Body [TDFN] With 1.4x1.3 mm Exposed Pad (JEDEC Package type WDFN)

**Note:** For the most current package drawings, please see the Microchip Packaging Specification located at <http://www.microchip.com/packaging>



Microchip Technology Drawing No. C04-129-MN Rev E Sheet 1 of 2

# 24AA04H/24LC04BH/24FC04H

## 8-Lead Plastic Dual Flat, No Lead Package (MN) – 2x3x0.8 mm Body [TDFN] With 1.4x1.3 mm Exposed Pad (JEDEC Package type WDFN)

**Note:** For the most current package drawings, please see the Microchip Packaging Specification located at <http://www.microchip.com/packaging>



Dimension Limits	Units	MILLIMETERS		
		MIN	NOM	MAX
Number of Pins	N	8		
Pitch	e	0.50 BSC		
Overall Height	A	0.70	0.75	0.80
Standoff	A1	0.00	0.02	0.05
Contact Thickness	A3	0.20 REF		
Overall Length	D	2.00 BSC		
Overall Width	E	3.00 BSC		
Exposed Pad Length	D2	1.35	1.40	1.45
Exposed Pad Width	E2	1.25	1.30	1.35
Contact Width	b	0.20	0.25	0.30
Contact Length	L	0.25	0.30	0.45
Contact-to-Exposed Pad	K	0.20	-	-

### Notes:

1. Pin 1 visual index feature may vary, but must be located within the hatched area.
2. Package may have one or more exposed tie bars at ends.
3. Package is saw singulated
4. Dimensioning and tolerancing per ASME Y14.5M

BSC: Basic Dimension. Theoretically exact value shown without tolerances.

REF: Reference Dimension, usually without tolerance, for information purposes only.

Microchip Technology Drawing No. C04-129-MN Rev E Sheet 2 of 2

# 24AA04H/24LC04BH/24FC04H

## 8-Lead Plastic Dual Flat, No Lead Package (MN) – 2x3x0.8 mm Body [TDFN] With 1.4x1.3 mm Exposed Pad (JEDEC Package type WDFN)

**Note:** For the most current package drawings, please see the Microchip Packaging Specification located at <http://www.microchip.com/packaging>



RECOMMENDED LAND PATTERN

Dimension Limits	Units	MILLIMETERS		
		MIN	NOM	MAX
Contact Pitch	E	0.50 BSC		
Optional Center Pad Width	X2			1.60
Optional Center Pad Length	Y2			1.50
Contact Pad Spacing	C		2.90	
Contact Pad Width (X8)	X1			0.25
Contact Pad Length (X8)	Y1			0.85
Thermal Via Diameter	V		0.30	
Thermal Via Pitch	EV		1.00	

**Notes:**

- Dimensioning and tolerancing per ASME Y14.5M  
BSC: Basic Dimension. Theoretically exact value shown without tolerances.
- For best soldering results, thermal vias, if used, should be filled or tented to avoid solder loss during reflow process

Microchip Technology Drawing No. C04-129-MN Rev. B

# 24AA04H/24LC04BH/24FC04H

## 8-Lead Ultra Thin Plastic Dual Flat, No Lead Package (Q4B) - 2x3 mm Body [UDFN] Atmel Legacy YNZ Package

**Note:** For the most current package drawings, please see the Microchip Packaging Specification located at <http://www.microchip.com/packaging>



Microchip Technology Drawing C04-21355-Q4B Rev A Sheet 1 of 2



# 24AA04H/24LC04BH/24FC04H

## 8-Lead Ultra Thin Plastic Dual Flat, No Lead Package (Q4B) - 2x3 mm Body [UDFN] Atmel Legacy YNZ Package

**Note:** For the most current package drawings, please see the Microchip Packaging Specification located at <http://www.microchip.com/packaging>



Dimension Limits	Units	MILLIMETERS		
		MIN	NOM	MAX
Number of Terminals	N	8		
Pitch	e	0.50 BSC		
Overall Height	A	0.50	0.55	0.60
Standoff	A1	0.00	0.02	0.05
Terminal Thickness	A3	0.152 REF		
Overall Length	D	2.00 BSC		
Exposed Pad Length	D2	1.40	1.50	1.60
Overall Width	E	3.00 BSC		
Exposed Pad Width	E2	1.20	1.30	1.40
Terminal Width	b	0.18	0.25	0.30
Terminal Length	L	0.35	0.40	0.45
Terminal-to-Exposed-Pad	K	0.20	-	-

**Notes:**

1. Pin 1 visual index feature may vary, but must be located within the hatched area.
2. Package is saw singulated
3. Dimensioning and tolerancing per ASME Y14.5M

BSC: Basic Dimension. Theoretically exact value shown without tolerances.

REF: Reference Dimension, usually without tolerance, for information purposes only.

Microchip Technology Drawing C04-21355-Q4B Rev A Sheet 2 of 2

# 24AA04H/24LC04BH/24FC04H

## 8-Lead Ultra Thin Plastic Dual Flat, No Lead Package (Q4B) - 2x3 mm Body [UDFN] Atmel Legacy YNZ Package

**Note:** For the most current package drawings, please see the Microchip Packaging Specification located at <http://www.microchip.com/packaging>



RECOMMENDED LAND PATTERN

Dimension Limits	Units	MILLIMETERS		
		MIN	NOM	MAX
Contact Pitch	E	0.50 BSC		
Optional Center Pad Width	X2			1.60
Optional Center Pad Length	Y2			1.40
Contact Pad Spacing	C		2.90	
Contact Pad Width (X8)	X1			0.30
Contact Pad Length (X8)	Y1			0.85
Contact Pad to Center Pad (X8)	G1	0.20		
Contact Pad to Contact Pad (X6)	G2	0.33		
Thermal Via Diameter	V		0.30	
Thermal Via Pitch	EV		1.00	

**Notes:**

1. Dimensioning and tolerancing per ASME Y14.5M  
BSC: Basic Dimension. Theoretically exact value shown without tolerances.
2. For best soldering results, thermal vias, if used, should be filled or tented to avoid solder loss during reflow process

Microchip Technology Drawing C04-21355-Q4B Rev A

## **APPENDIX A: REVISION HISTORY**

### **Revision B (01/2019)**

Added the 24FC04H device; Updated Package Drawings; Updated content throughout for clarification.

### **Revision A (11/2008)**

Original release.

# 24AA04H/24LC04BH/24FC04H

---

NOTES:

## THE MICROCHIP WEBSITE

Microchip provides online support via our website at [www.microchip.com](http://www.microchip.com). This website is used as a means to make files and information easily available to customers. Accessible by using your favorite Internet browser, the website contains the following information:

- **Product Support** – Data sheets and errata, application notes and sample programs, design resources, user's guides and hardware support documents, latest software releases and archived software
- **General Technical Support** – Frequently Asked Questions (FAQ), technical support requests, online discussion groups, Microchip consultant program member listing
- **Business of Microchip** – Product selector and ordering guides, latest Microchip press releases, listing of seminars and events, listings of Microchip sales offices, distributors and factory representatives

## CUSTOMER CHANGE NOTIFICATION SERVICE

Microchip's customer notification service helps keep customers current on Microchip products. Subscribers will receive e-mail notification whenever there are changes, updates, revisions or errata related to a specified product family or development tool of interest.

To register, access the Microchip website at [www.microchip.com](http://www.microchip.com). Under "Support", click on "Customer Change Notification" and follow the registration instructions.

## CUSTOMER SUPPORT

Users of Microchip products can receive assistance through several channels:

- Distributor or Representative
- Local Sales Office
- Field Application Engineer (FAE)
- Technical Support

Customers should contact their distributor, representative or Field Application Engineer (FAE) for support. Local sales offices are also available to help customers. A listing of sales offices and locations is included in the back of this document.

**Technical support is available through the website at: <http://microchip.com/support>**

# 24AA04H/24LC04BH/24FC04H

---

NOTES:

# 24AA04H/24LC04BH/24FC04H

## PRODUCT IDENTIFICATION SYSTEM

To order or obtain information, e.g., on pricing or delivery, refer to the factory or the listed sales office.

<u>PART NO.</u>	<u>XI</u> <sup>(1)</sup>	<u>X</u>	<u>XX</u>	
Device	Tape and Reel Option	Temperature Range	Package	
<p><b>Device:</b></p> <p>24AA04H: = 1.7V, 4-Kbit I<sup>2</sup>C Serial EEPROM</p> <p>24LC04BH: = 2.5V, 4-Kbit I<sup>2</sup>C Serial EEPROM</p> <p>24FC04H: = 1.7V, High Speed 4-Kbit I<sup>2</sup>C Serial EEPROM</p>				
<p><b>Tape and Reel Option:</b></p> <p>Blank = -Standard packaging (tube or tray)</p> <p>T = Tape and Reel <sup>(1)</sup></p>				
<p><b>Temperature Range:</b></p> <p>I = -40°C to +85°C (Industrial)</p> <p>E = -40°C to +125°C (Extended)</p>				
<p><b>Package:</b></p> <p>P = Plastic Dual In-Line - 300 mil Body, 8-lead (PDIP)</p> <p>SN = Plastic Small Outline - Narrow, 3.90 mm Body, 8-lead (SOIC)</p> <p>ST = Plastic Thin Shrink Small Outline - 4.4 mm, 8-lead (TSSOP)</p> <p>MNY = Plastic Dual Flat, No Lead Package - 2x3x0.8 mm Body, 8-lead (TDFN)</p> <p>MS = Plastic Micro Small Outline Package, 8-lead (MSOP)</p> <p>OT = Plastic Small Outline Transistor, 5-lead (SOT-23) (Tape and Reel only)</p> <p>MUY = Plastic Dual Flat, No Lead Package - 2x3x0.6 mm Body, 8-lead (UDFN)</p>				
				<p><b>Examples:</b></p> <p>a) 24AA04H-I/P: Industrial Temperature, 1.7V, PDIP package</p> <p>b) 24AA04H-I/SN: Industrial Temperature, 1.7V, SOIC package</p> <p>c) 24AA04HT-I/OT: Tape and Reel, Industrial Temperature, 1.7V, SOT-23 package</p> <p>d) 24LC04BH-I/P: Industrial Temperature, 2.5V, PDIP package</p> <p>e) 24LC04BH-E/SN: Extended Temp., 2.5V SOIC package</p> <p>f) 24LC04BHT-I/OT: Tape and Reel, Industrial Temperature, 2.5V, SOT-23 package</p> <p>g) 24AA04HT-I/MNY: Tape and Reel, Industrial Temperature, 1.7V, TDFN package</p> <p>h) 24FC04H-I/SN: Industrial Temperature, 1.7V, SOIC package</p> <p>i) 24FC04HT-E/ST: Tape and Reel, Extended Temperature, 1.7V, TSSOP package</p> <p>j) 24FC04HT-I/MUY: Tape and Reel, Industrial Temperature, 1.7V, UDFN package</p> <p><b>Note 1:</b> Tape and Reel identifier only appears in the catalog part number description. This identifier is used for ordering purposes and is not printed on the device package. Check with your Microchip Sales Office for package availability with the Tape and Reel option.</p> <p><b>2:</b> Contact Microchip for Automotive grade ordering part numbers.</p>

# 24AA04H/24LC04BH/24FC04H

---

NOTES:



# 24AA04H/24LC04BH/24FC04H

---

**Note the following details of the code protection feature on Microchip devices:**

- Microchip products meet the specification contained in their particular Microchip Data Sheet.
- Microchip believes that its family of products is one of the most secure families of its kind on the market today, when used in the intended manner and under normal conditions.
- There are dishonest and possibly illegal methods used to breach the code protection feature. All of these methods, to our knowledge, require using the Microchip products in a manner outside the operating specifications contained in Microchip's Data Sheets. Most likely, the person doing so is engaged in theft of intellectual property.
- Microchip is willing to work with the customer who is concerned about the integrity of their code.
- Neither Microchip nor any other semiconductor manufacturer can guarantee the security of their code. Code protection does not mean that we are guaranteeing the product as “unbreakable.”

Code protection is constantly evolving. We at Microchip are committed to continuously improving the code protection features of our products. Attempts to break Microchip's code protection feature may be a violation of the Digital Millennium Copyright Act. If such acts allow unauthorized access to your software or other copyrighted work, you may have a right to sue for relief under that Act.

---

Information contained in this publication regarding device applications and the like is provided only for your convenience and may be superseded by updates. It is your responsibility to ensure that your application meets with your specifications. MICROCHIP MAKES NO REPRESENTATIONS OR WARRANTIES OF ANY KIND WHETHER EXPRESS OR IMPLIED, WRITTEN OR ORAL, STATUTORY OR OTHERWISE, RELATED TO THE INFORMATION, INCLUDING BUT NOT LIMITED TO ITS CONDITION, QUALITY, PERFORMANCE, MERCHANTABILITY OR FITNESS FOR PURPOSE. Microchip disclaims all liability arising from this information and its use. Use of Microchip devices in life support and/or safety applications is entirely at the buyer's risk, and the buyer agrees to defend, indemnify and hold harmless Microchip from any and all damages, claims, suits, or expenses resulting from such use. No licenses are conveyed, implicitly or otherwise, under any Microchip intellectual property rights unless otherwise stated.

*Microchip received ISO/TS-16949:2009 certification for its worldwide headquarters, design and wafer fabrication facilities in Chandler and Tempe, Arizona; Gresham, Oregon and design centers in California and India. The Company's quality system processes and procedures are for its PIC® MCUs and dsPIC® DSCs, KEELOQ® code hopping devices, Serial EEPROMs, microperipherals, nonvolatile memory and analog products. In addition, Microchip's quality system for the design and manufacture of development systems is ISO 9001:2000 certified.*

**QUALITY MANAGEMENT SYSTEM  
CERTIFIED BY DNV  
= ISO/TS 16949 =**

## Trademarks

The Microchip name and logo, the Microchip logo, AnyRate, AVR, AVR logo, AVR Freaks, BitCloud, chipKIT, chipKIT logo, CryptoMemory, CryptoRF, dsPIC, FlashFlex, flexPWR, Helder, JukeBlox, KeeLoq, Klear, LANCheck, LINK MD, maXStylus, maXTouch, MediaLB, megaAVR, MOST, MOST logo, MPLAB, OptoLyzer, PIC, picoPower, PICSTART, PIC32 logo, Prochip Designer, QTouch, SAM-BA, SpyNIC, SST, SST Logo, SuperFlash, tinyAVR, UNI/O, and XMEGA are registered trademarks of Microchip Technology Incorporated in the U.S.A. and other countries.

ClockWorks, The Embedded Control Solutions Company, EtherSynch, Hyper Speed Control, HyperLight Load, IntelliMOS, mTouch, Precision Edge, and Quiet-Wire are registered trademarks of Microchip Technology Incorporated in the U.S.A.

Adjacent Key Suppression, AKS, Analog-for-the-Digital Age, Any Capacitor, AnyIn, AnyOut, BodyCom, CodeGuard, CryptoAuthentication, CryptoAutomotive, CryptoCompanion, CryptoController, dsPICDEM, dsPICDEM.net, Dynamic Average Matching, DAM, ECAN, EtherGREEN, In-Circuit Serial Programming, ICSP, INICnet, Inter-Chip Connectivity, JitterBlocker, KlearNet, KlearNet logo, memBrain, Mindi, MiWi, motorBench, MPASM, MPF, MPLAB Certified logo, MPLIB, MPLINK, MultiTRAK, NetDetach, Omniscient Code Generation, PICDEM, PICDEM.net, PICKit, PICtail, PowerSmart, PureSilicon, QMatrix, REAL ICE, Ripple Blocker, SAM-ICE, Serial Quad I/O, SMART-I.S., SQI, SuperSwitcher, SuperSwitcher II, Total Endurance, TSHARC, USBCheck, VariSense, ViewSpan, WiperLock, Wireless DNA, and ZENA are trademarks of Microchip Technology Incorporated in the U.S.A. and other countries.

SQTP is a service mark of Microchip Technology Incorporated in the U.S.A.

Silicon Storage Technology is a registered trademark of Microchip Technology Inc. in other countries.

GestIC is a registered trademark of Microchip Technology Germany II GmbH & Co. KG, a subsidiary of Microchip Technology Inc., in other countries.

All other trademarks mentioned herein are property of their respective companies.

© 2018, Microchip Technology Incorporated, All Rights Reserved.  
ISBN: 978-1-5224-4048-2



# MICROCHIP

## Worldwide Sales and Service

### AMERICAS

**Corporate Office**  
2355 West Chandler Blvd.  
Chandler, AZ 85224-6199  
Tel: 480-792-7200  
Fax: 480-792-7277  
Technical Support:  
<http://www.microchip.com/support>  
Web Address:  
[www.microchip.com](http://www.microchip.com)

#### Atlanta

Duluth, GA  
Tel: 678-957-9614  
Fax: 678-957-1455

#### Austin, TX

Tel: 512-257-3370

#### Boston

Westborough, MA  
Tel: 774-760-0087  
Fax: 774-760-0088

#### Chicago

Itasca, IL  
Tel: 630-285-0071  
Fax: 630-285-0075

#### Dallas

Addison, TX  
Tel: 972-818-7423  
Fax: 972-818-2924

#### Detroit

Novi, MI  
Tel: 248-848-4000

#### Houston, TX

Tel: 281-894-5983

#### Indianapolis

Noblesville, IN  
Tel: 317-773-8323  
Fax: 317-773-5453  
Tel: 317-536-2380

#### Los Angeles

Mission Viejo, CA  
Tel: 949-462-9523  
Fax: 949-462-9608  
Tel: 951-273-7800

#### Raleigh, NC

Tel: 919-844-7510

#### New York, NY

Tel: 631-435-6000

#### San Jose, CA

Tel: 408-735-9110  
Tel: 408-436-4270

#### Canada - Toronto

Tel: 905-695-1980  
Fax: 905-695-2078

### ASIA/PACIFIC

**Australia - Sydney**  
Tel: 61-2-9868-6733

**China - Beijing**  
Tel: 86-10-8569-7000

**China - Chengdu**  
Tel: 86-28-8665-5511

**China - Chongqing**  
Tel: 86-23-8980-9588

**China - Dongguan**  
Tel: 86-769-8702-9880

**China - Guangzhou**  
Tel: 86-20-8755-8029

**China - Hangzhou**  
Tel: 86-571-8792-8115

**China - Hong Kong SAR**  
Tel: 852-2943-5100

**China - Nanjing**  
Tel: 86-25-8473-2460

**China - Qingdao**  
Tel: 86-532-8502-7355

**China - Shanghai**  
Tel: 86-21-3326-8000

**China - Shenyang**  
Tel: 86-24-2334-2829

**China - Shenzhen**  
Tel: 86-755-8864-2200

**China - Suzhou**  
Tel: 86-186-6233-1526

**China - Wuhan**  
Tel: 86-27-5980-5300

**China - Xian**  
Tel: 86-29-8833-7252

**China - Xiamen**  
Tel: 86-592-2388138

**China - Zhuhai**  
Tel: 86-756-3210040

### ASIA/PACIFIC

**India - Bangalore**  
Tel: 91-80-3090-4444

**India - New Delhi**  
Tel: 91-11-4160-8631

**India - Pune**  
Tel: 91-20-4121-0141

**Japan - Osaka**  
Tel: 81-6-6152-7160

**Japan - Tokyo**  
Tel: 81-3-6880-3770

**Korea - Daegu**  
Tel: 82-53-744-4301

**Korea - Seoul**  
Tel: 82-2-554-7200

**Malaysia - Kuala Lumpur**  
Tel: 60-3-7651-7906

**Malaysia - Penang**  
Tel: 60-4-227-8870

**Philippines - Manila**  
Tel: 63-2-634-9065

**Singapore**  
Tel: 65-6334-8870

**Taiwan - Hsin Chu**  
Tel: 886-3-577-8366

**Taiwan - Kaohsiung**  
Tel: 886-7-213-7830

**Taiwan - Taipei**  
Tel: 886-2-2508-8600

**Thailand - Bangkok**  
Tel: 66-2-694-1351

**Vietnam - Ho Chi Minh**  
Tel: 84-28-5448-2100

### EUROPE

**Austria - Wels**  
Tel: 43-7242-2244-39  
Fax: 43-7242-2244-393

**Denmark - Copenhagen**  
Tel: 45-4450-2828  
Fax: 45-4485-2829

**Finland - Espoo**  
Tel: 358-9-4520-820

**France - Paris**  
Tel: 33-1-69-53-63-20  
Fax: 33-1-69-30-90-79

**Germany - Garching**  
Tel: 49-8931-9700

**Germany - Haan**  
Tel: 49-2129-3766400

**Germany - Heilbronn**  
Tel: 49-7131-67-3636

**Germany - Karlsruhe**  
Tel: 49-721-625370

**Germany - Munich**  
Tel: 49-89-627-144-0  
Fax: 49-89-627-144-44

**Germany - Rosenheim**  
Tel: 49-8031-354-560

**Israel - Ra'anana**  
Tel: 972-9-744-7705

**Italy - Milan**  
Tel: 39-0331-742611  
Fax: 39-0331-466781

**Italy - Padova**  
Tel: 39-049-7625286

**Netherlands - Drunen**  
Tel: 31-416-690399  
Fax: 31-416-690340

**Norway - Trondheim**  
Tel: 47-7288-4388

**Poland - Warsaw**  
Tel: 48-22-3325737

**Romania - Bucharest**  
Tel: 40-21-407-87-50

**Spain - Madrid**  
Tel: 34-91-708-08-90  
Fax: 34-91-708-08-91

**Sweden - Gothenberg**  
Tel: 46-31-704-60-40

**Sweden - Stockholm**  
Tel: 46-8-5090-4654

**UK - Wokingham**  
Tel: 44-118-921-5800  
Fax: 44-118-921-5820

# Mouser Electronics

Authorized Distributor

Click to View Pricing, Inventory, Delivery & Lifecycle Information:

## Microchip:

[24AA04H-I/P](#) [24LC04BH-I/SN](#) [24AA04HT-I/MC](#) [24AA04HT-I/MS](#) [24LC04BH-I/ST](#) [24LC04BHT-I/ST](#) [24AA04H-I/MS](#)  
[24AA04HT-I/SN](#) [24AA04HT-I/OT](#) [24LC04BH-I/P](#) [24LC04BH-E/SN](#) [24LC04BHT-E/ST](#) [24LC04BH-E/P](#) [24AA04H-](#)  
[I/ST](#) [24AA04H-I/SN](#) [24LC04BHT-E/SN](#) [24LC04BHT-I/MC](#) [24LC04BHT-I/SN](#) [24LC04BHT-I/MS](#) [24AA04HT-I/ST](#)  
[24LC04BH-E/ST](#) [24LC04BHT-E/OT](#) [24LC04BH-I/MS](#) [24LC04BH-E/MS](#) [24LC04BHT-I/OT](#) [24LC04BHT-E/MS](#)  
[24LC04BHT-I/MNY](#) [24LC04BH-E/MNY](#) [24LC04BH-I/MNY](#) [24LC04BHT-E/MNY](#) [24AA04HT-I/MNY](#) [24FC04H-I/SN](#)  
[24FC04HT-I/OT](#) [24FC04HT-I/SN](#) [24FC04H-I/ST](#) [24FC04HT-I/MUY](#) [24FC04HT-I/ST](#) [24FC04HT-I/MS](#) [24FC04H-I/MS](#)  
[24FC04H-I/P](#) [24FC04HT-E/MUY](#) [24FC04HT-E/MS](#) [24FC04H-E/MS](#) [24FC04H-E/SN](#) [24FC04HT-E/OT](#) [24FC04H-](#)  
[E/P](#) [24FC04HT-E/SN](#) [24FC04HT-E/ST](#) [24FC04H-E/ST](#)

Компания «Океан Электроники» предлагает заключение долгосрочных отношений при поставках импортных электронных компонентов на взаимовыгодных условиях!

Наши преимущества:

- Поставка оригинальных импортных электронных компонентов напрямую с производств Америки, Европы и Азии, а так же с крупнейших складов мира;
- Широкая линейка поставок активных и пассивных импортных электронных компонентов (более 30 млн. наименований);
- Поставка сложных, дефицитных, либо снятых с производства позиций;
- Оперативные сроки поставки под заказ (от 5 рабочих дней);
- Экспресс доставка в любую точку России;
- Помощь Конструкторского Отдела и консультации квалифицированных инженеров;
- Техническая поддержка проекта, помощь в подборе аналогов, поставка прототипов;
- Поставка электронных компонентов под контролем ВП;
- Система менеджмента качества сертифицирована по Международному стандарту ISO 9001;
- При необходимости вся продукция военного и аэрокосмического назначения проходит испытания и сертификацию в лаборатории (по согласованию с заказчиком);
- Поставка специализированных компонентов военного и аэрокосмического уровня качества (Xilinx, Altera, Analog Devices, Intersil, Interpoint, Microsemi, Actel, Aeroflex, Peregrine, VPT, Syfer, Eurofarad, Texas Instruments, MS Kennedy, Miteq, Cobham, E2V, MA-COM, Hittite, Mini-Circuits, General Dynamics и др.);

Компания «Океан Электроники» является официальным дистрибьютором и эксклюзивным представителем в России одного из крупнейших производителей разъемов военного и аэрокосмического назначения «JONHON», а так же официальным дистрибьютором и эксклюзивным представителем в России производителя высокотехнологичных и надежных решений для передачи СВЧ сигналов «FORSTAR».



## JONHON

«JONHON» (основан в 1970 г.)

Разъемы специального, военного и аэрокосмического назначения:

(Применяются в военной, авиационной, аэрокосмической, морской, железнодорожной, горно- и нефтедобывающей отраслях промышленности)

«FORSTAR» (основан в 1998 г.)

ВЧ соединители, коаксиальные кабели, кабельные сборки и микроволновые компоненты:

(Применяются в телекоммуникациях гражданского и специального назначения, в средствах связи, РЛС, а так же военной, авиационной и аэрокосмической отраслях промышленности).



Телефон: 8 (812) 309-75-97 (многоканальный)

Факс: 8 (812) 320-03-32

Электронная почта: [ocean@oceanchips.ru](mailto:ocean@oceanchips.ru)

Web: <http://oceanchips.ru/>

Адрес: 198099, г. Санкт-Петербург, ул. Калинина, д. 2, корп. 4, лит. А