

NCV8703

300 mA, Ultra-Low Quiescent Current, I_Q 12 μ A, Ultra-Low Noise, LDO Voltage Regulator

The NCV8703 is a low noise, low power consumption and low dropout Linear Voltage Regulator. With its excellent noise and PSRR specifications, the device is ideal for use in products utilizing RF receivers, imaging sensors, audio processors or any component requiring an extremely clean power supply. The NCV8703 uses an innovative Adaptive Ground Current circuit to ensure ultra low ground current during light load conditions.

Features

- Operating Input Voltage Range: 2.0 V to 5.5 V
- Available in Fixed Voltage Options: 0.8 to 3.5 V
Contact Factory for Other Voltage Options
- Ultra-Low Quiescent Current of Typ. 12 μ A
- Ultra-Low Noise: 13 μ V_{RMS} from 100 Hz to 100 kHz
- Very Low Dropout: 180 mV Typical at 300 mA
- $\pm 2\%$ Accuracy Over Load/Line/Temperature
- High PSRR: 68 dB at 1 kHz
- Internal Soft-Start to Limit the Turn-On Inrush Current
- Thermal Shutdown and Current Limit Protections
- Stable with a 1 μ F Ceramic Output Capacitor
- Available in TSOP-5 and XDFN 1.5 x 1.5 mm Package
- Active Output Discharge for Fast Turn-Off
- NCV Prefix for Automotive and Other Applications Requiring Unique Site and Control Change Requirements; AEC-Q100 Qualified and PPAP Capable
- These are Pb-Free Devices

Typical Applications

- Satellite Radio Receivers, GPS
- Rear View Camera, Electronic Mirrors, Lane Change Detectors
- Portable Entertainment Systems
- Other Battery Powered Applications

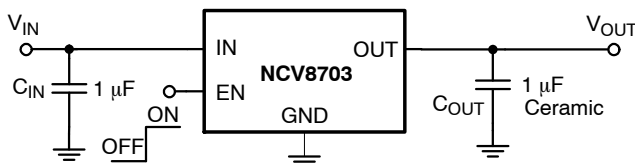
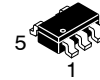

Figure 1. Typical Application Schematic



ON Semiconductor®

<http://onsemi.com>



TSOP-5
SN SUFFIX
CASE 483



XDFN6
MX SUFFIX
CASE 711AE

MARKING DIAGRAMS

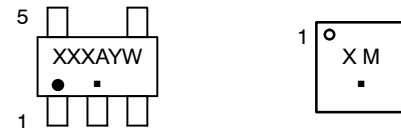

X, XXX = Specific Device Code
M = Date Code
A = Assembly Location
Y = Year
W = Work Week
▪ = Pb-Free Package

PIN CONNECTIONS

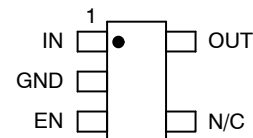

5-Pin TSOP-5
(Top View)

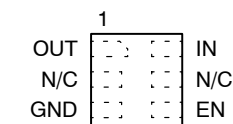

6-Pin XDFN 1.5 x 1.5 mm
(Top View)

ORDERING INFORMATION

See detailed ordering and shipping information in the package dimensions section on page 16 of this data sheet.

NCV8703

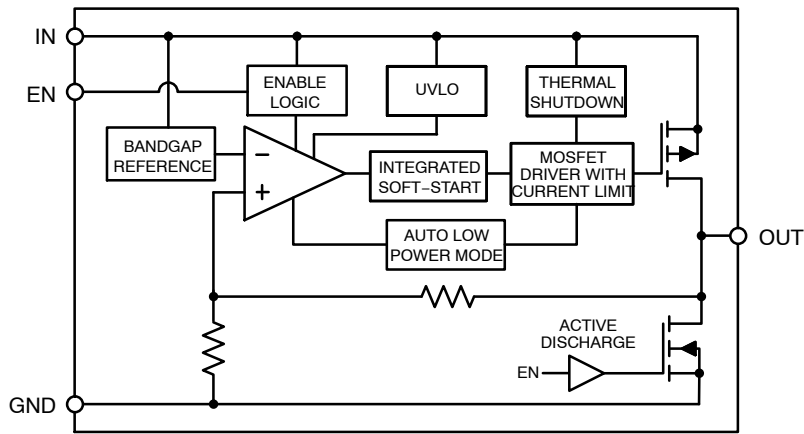

Figure 2. Simplified Schematic Block Diagram

Table 1. PIN FUNCTION DESCRIPTION

Pin No. XDFN6	Pin No. TSOP-5	Pin Name	Description
1	5	OUT	Regulated output voltage pin. A small 1 μ F ceramic capacitor is needed from this pin to ground to assure stability.
2	4	N/C	Not connected.
3	2	GND	Power supply ground. Connected to the die through the lead frame. Soldered to the copper plane allows for effective heat dissipation.
4	3	EN	Enable pin. Driving EN over 0.9 V turns on the regulator. Driving EN below 0.4 V puts the regulator into shutdown mode.
5		N/C	Not connected. This pin can be tied to ground to improve thermal dissipation.
6	1	IN	Input pin. A small capacitor is needed from this pin to ground to assure stability.

Table 2. ABSOLUTE MAXIMUM RATINGS

Rating	Symbol	Value	Unit
Input Voltage (Note 1)	V_{IN}	-0.3 V to 6 V	V
Output Voltage	V_{OUT}	-0.3 V to $V_{IN} + 0.3$ V	V
Enable Input	V_{EN}	-0.3 V to $V_{IN} + 0.3$ V	V
Output Short Circuit Duration	t_{SC}	Indefinite	s
Maximum Junction Temperature	$T_{J(MAX)}$	125	$^{\circ}$ C
Storage Temperature	T_{STG}	-55 to 150	$^{\circ}$ C
ESD Capability, Human Body Model (Note 2)	ESD_{HBM}	2000	V
ESD Capability, Machine Model (Note 2)	ESD_{MM}	200	V

Stresses exceeding Maximum Ratings may damage the device. Maximum Ratings are stress ratings only. Functional operation above the Recommended Operating Conditions is not implied. Extended exposure to stresses above the Recommended Operating Conditions may affect device reliability.

1. Refer to ELECTRICAL CHARACTERISTICS and APPLICATION INFORMATION for Safe Operating Area.
2. This device series incorporates ESD protection and is tested by the following methods:
 ESD Human Body Model tested per AEC-Q100-002 (EIA/JESD22-A114)
 ESD Machine Model tested per AEC-Q100-003 (EIA/JESD22-A115)
 Latchup Current Maximum Rating tested per JEDEC standard: JESD78.

Table 3. THERMAL CHARACTERISTICS (Note 3)

Rating	Symbol	Value	Unit
Thermal Characteristics, TSOP-5, Thermal Resistance, Junction-to-Air Thermal Characterization Parameter, Junction-to-Lead (Pin 2)	θ_{JA} ψ_{JL}	241 129	$^{\circ}\text{C}/\text{W}$
Thermal Characteristics, XDFN6 1.5 x 1.5 mm Thermal Resistance, Junction-to-Air Thermal Characterization Parameter, Junction-to-Board	θ_{JA} ψ_{JB}	146 77	$^{\circ}\text{C}/\text{W}$

3. Single component mounted on 1 oz, FR4 PCB with 645 mm² Cu area.

Table 4. ELECTRICAL CHARACTERISTICS

-40°C ≤ T_J ≤ 125°C; V_{IN} = V_{OUT(NOM)} + 0.5 V or 2.0 V, whichever is greater; V_{EN} = 0.9 V, I_{OUT} = 10 mA, C_{IN} = C_{OUT} = 1 μF unless otherwise noted. Typical values are at T_J = +25°C. (Note 4)

Parameter	Test Conditions	Symbol	Min	Typ	Max	Unit
Operating Input Voltage		V _{IN}	2.0		5.5	V
Undervoltage Lock-out	V _{IN} rising	UVLO	1.2	1.6	1.9	V
Output Voltage Accuracy	V _{OUT} + 0.5 V ≤ V _{IN} ≤ 5.5 V, I _{OUT} = 0 – 300 mA	V _{OUT}	-2		+2	%
Line Regulation	V _{OUT} + 0.5 V ≤ V _{IN} ≤ 4.5 V, I _{OUT} = 10 mA	Reg _{LINE}		450		μV/V
	V _{OUT} + 0.5 V ≤ V _{IN} ≤ 5.5 V, I _{OUT} = 10 mA	Reg _{LINE}		600		μV/V
Load Regulation	I _{OUT} = 0 mA to 300 mA	Reg _{LOAD}		20		μV/mA
Load Transient	I _{OUT} = 1 mA to 300 mA or 300 mA to 1 mA in 1 μs, C _{OUT} = 1 μF	Tran _{LOAD}		-100/ +150		mV
Dropout Voltage (Note 5)	I _{OUT} = 300 mA, V _{OUT(nom)} = 2.5 V	V _{DO}		180	300	mV
Output Current Limit	V _{OUT} = 90% V _{OUT(nom)}	I _{CL}	310	450	750	mA
Quiescent Current	I _{OUT} = 0 mA	I _Q		12	20	μA
Ground Current	I _{OUT} = 300 mA	I _{GND}		200		μA
Shutdown Current	V _{EN} ≤ 0.4 V, T _J = +25°C	I _{DIS}		0.12		μA
	V _{EN} ≤ 0 V, V _{IN} = 2.0 to 4.5 V, T _J = -40 to +85°C	I _{DIS}		0.55	2	μA
EN Pin Threshold Voltage						V
High Threshold	V _{EN} Voltage increasing	V _{EN_HI}	0.9			
Low Threshold	V _{EN} Voltage decreasing	V _{EN_LO}			0.4	
EN Pin Input Current	V _{EN} = 5.5 V	I _{EN}		100	500	nA
Turn-On Time	C _{OUT} = 1.0 μF, from assertion EN pin to 98% V _{OUT(nom)}	t _{ON}		200		μs
Power Supply Rejection Ratio	V _{IN} = 3 V, V _{OUT} = 2.5 V I _{OUT} = 300 mA	PSRR	f = 100 Hz	70		dB
			f = 1 kHz	68		
			f = 10 kHz	53		
Output Noise Voltage	V _{OUT} = 2.5 V, V _{IN} = 3 V, I _{OUT} = 300 mA f = 100 Hz to 100 kHz	V _N		13		μV _{rms}
Thermal Shutdown Temperature	Temperature increasing from T _J = +25°C	T _{SD}		160		$^{\circ}\text{C}$
Thermal Shutdown Hysteresis	Temperature falling from T _{SD}	T _{SDH}	-	20	-	$^{\circ}\text{C}$

4. Performance guaranteed over the indicated operating temperature range by design and/or characterization. Production tested at T_J = T_A = 25°C. Low duty cycle pulse techniques are used during testing to maintain the junction temperature as close to ambient as possible.

5. Characterized when V_{OUT} falls 100 mV below the regulated voltage at V_{IN} = V_{OUT(NOM)} + 0.5 V.

TYPICAL CHARACTERISTICS

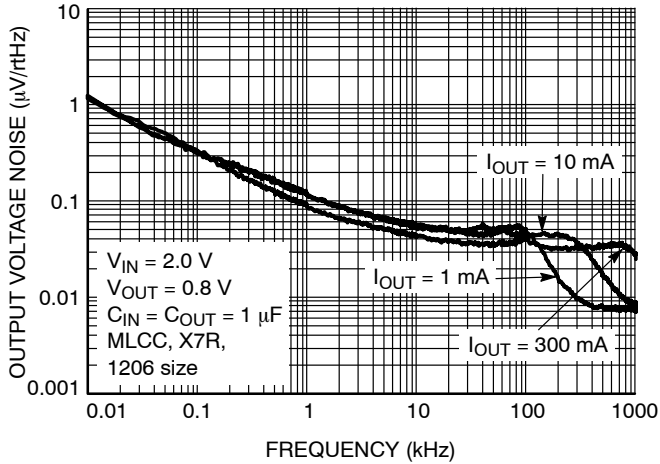

I _{OUT}	RMS Output Noise (μV _{RMS})	
	10 Hz – 100 kHz	100 Hz – 100 kHz
1 mA	18.45	17.77
10 mA	17.18	16.43
300 mA	14.14	13.11

Figure 3. Output Voltage Noise Spectral Density for V_{OUT} = 0.8 V, C_{OUT} = 1 μF

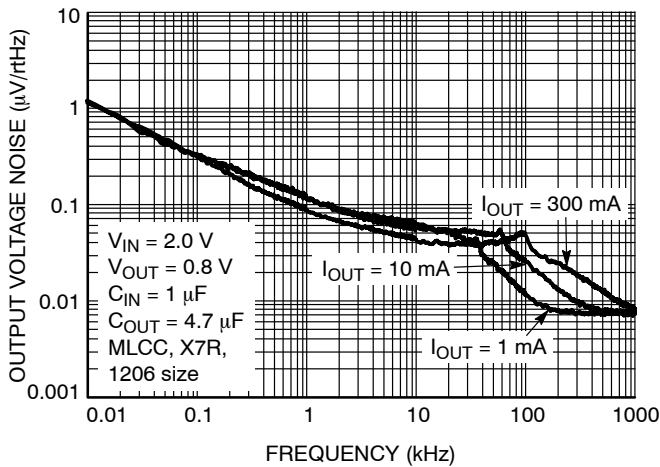

I _{OUT}	RMS Output Noise (μV _{RMS})	
	10 Hz – 100 kHz	100 Hz – 100 kHz
1 mA	14.07	13.14
10 mA	16.59	15.83
300 mA	15.46	14.53

Figure 4. Output Voltage Noise Spectral Density for V_{OUT} = 0.8 V, C_{OUT} = 4.7 μF

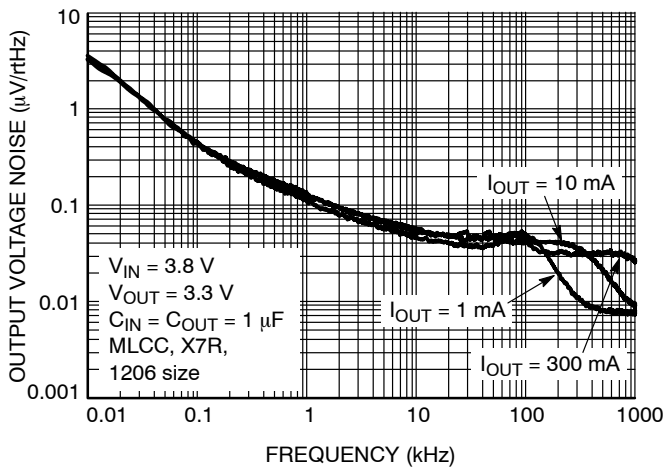

I _{OUT}	RMS Output Noise (μV _{RMS})	
	10 Hz – 100 kHz	100 Hz – 100 kHz
1 mA	20.29	17.06
10 mA	19.76	16.11
300 mA	18.74	15.46

Figure 5. Output Voltage Noise Spectral Density for V_{OUT} = 3.3 V, C_{OUT} = 1 μF

TYPICAL CHARACTERISTICS

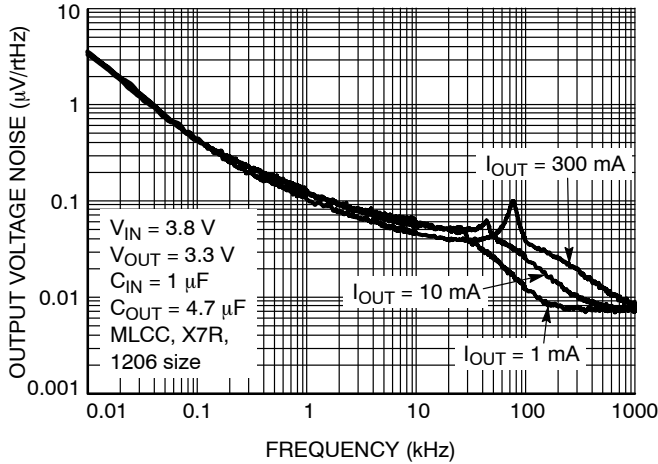

I _{OUT}	RMS Output Noise (µV _{RMS})	
	10 Hz – 100 kHz	100 Hz – 100 kHz
1 mA	17.64	13.52
10 mA	19.54	15.96
300 mA	21.50	18.71

Figure 6. Output Voltage Noise Spectral Density for V_{OUT} = 3.3 V, C_{OUT} = 4.7 µF

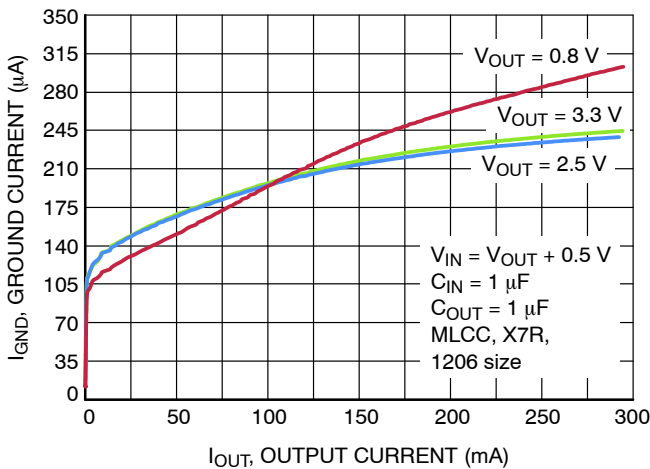

Figure 7. Ground Current vs. Output Current

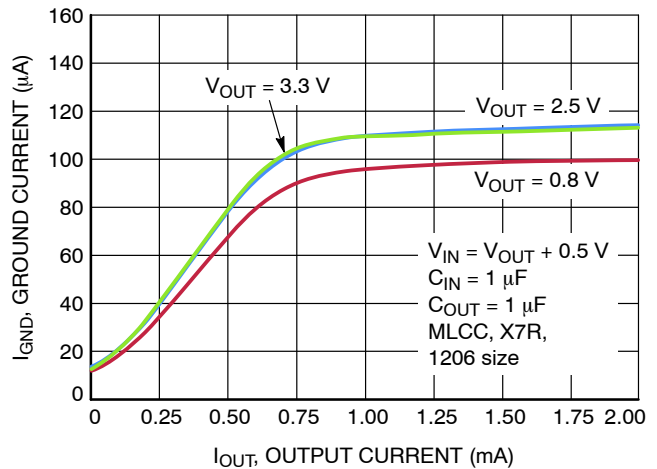

Figure 8. Ground Current vs. Output Current from 0 mA to 2 mA

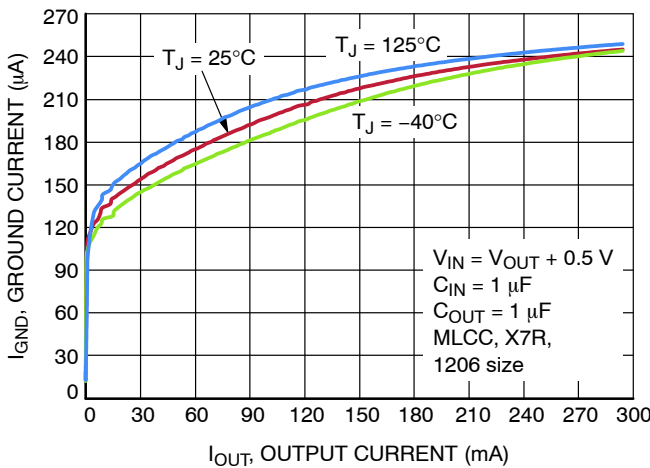

Figure 9. Ground Current vs. Output Current at Temperatures

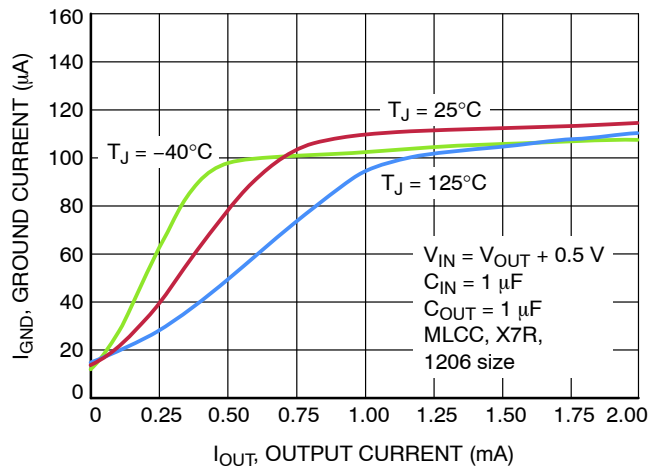

Figure 10. Ground Current vs. Output Current 0 mA to 2 mA at Temperatures

TYPICAL CHARACTERISTICS

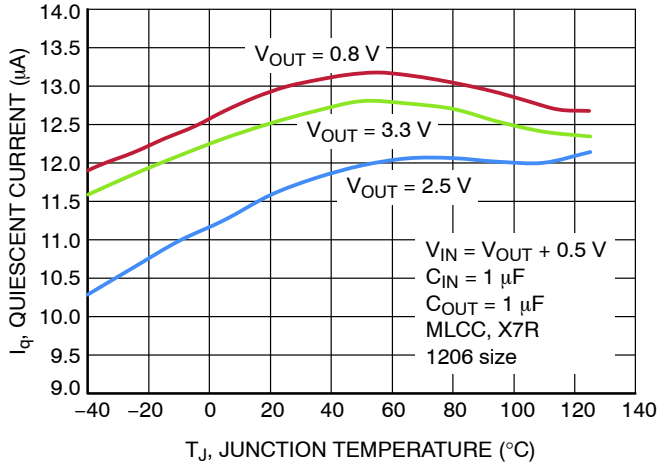

Figure 11. Quiescent Current vs. Temperature

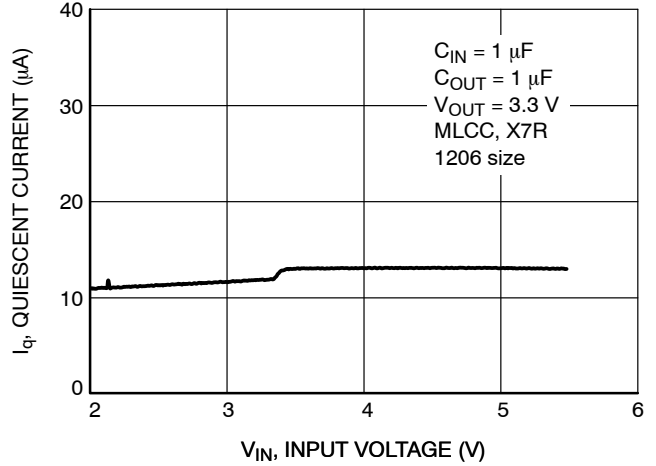

Figure 12. Quiescent Current vs. Input Voltage

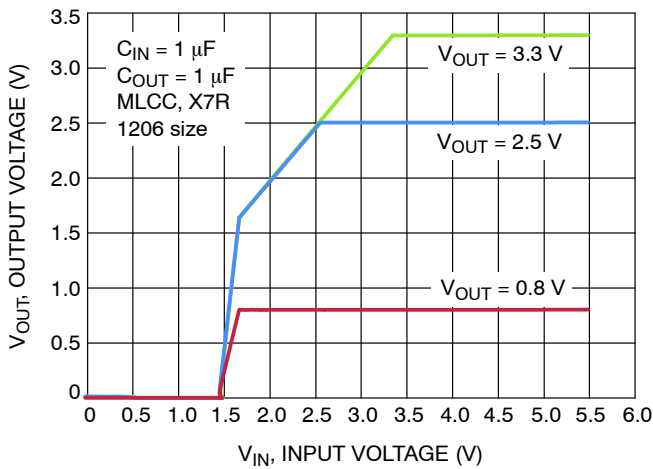

Figure 13. Output Voltage vs. Input Voltage

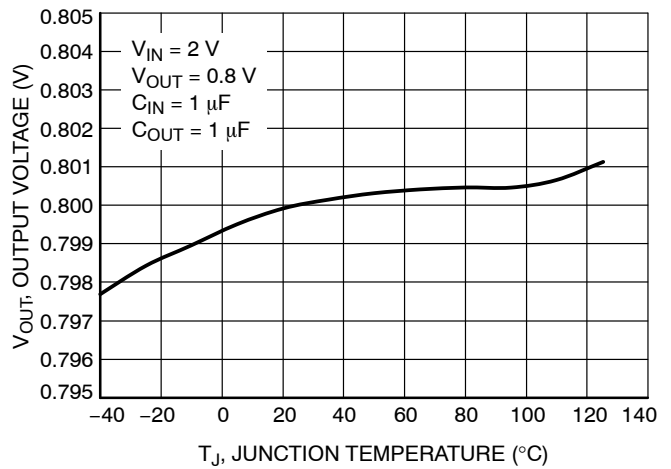

Figure 14. Output Voltage vs. Temperature – 0.8 V

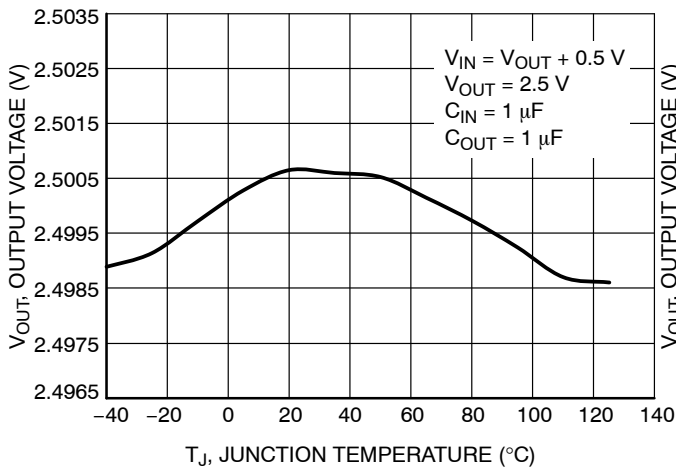

Figure 15. Output Voltage vs. Temperature – 2.5 V

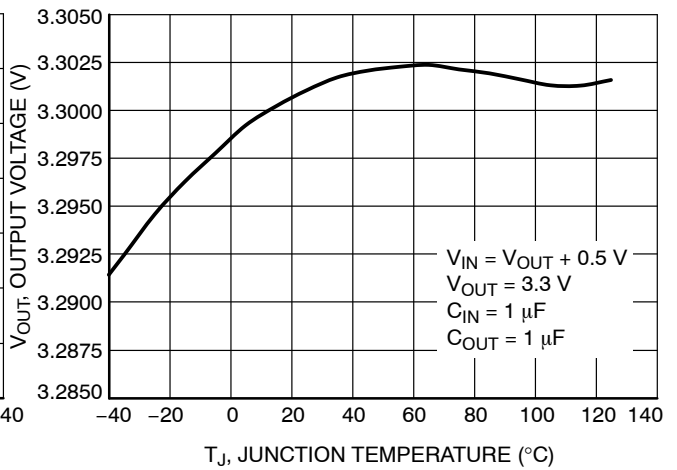

Figure 16. Output Voltage vs. Temperature – 3.3 V

TYPICAL CHARACTERISTICS

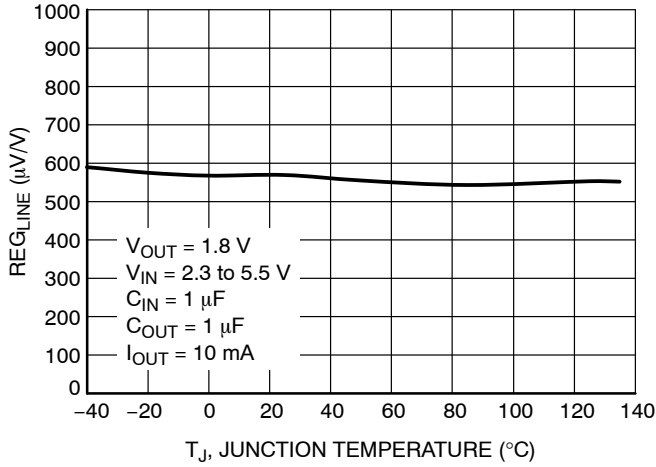

Figure 17. Line Regulation vs. Temperature – 1.8 V

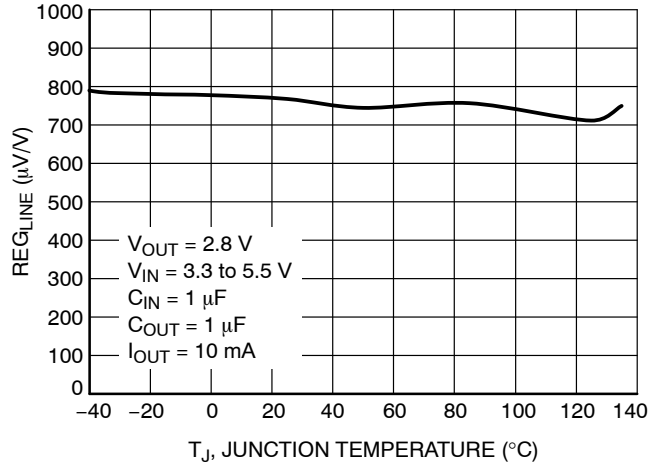

Figure 18. Line Regulation vs. Temperature – 2.8 V

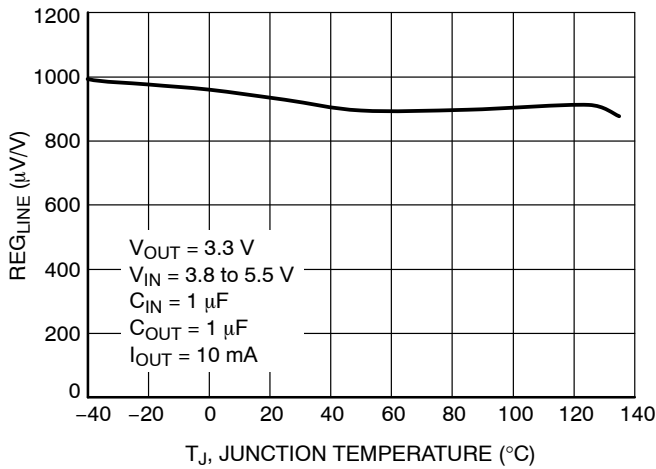

Figure 19. Line Regulation vs. Temperature – 3.3 V

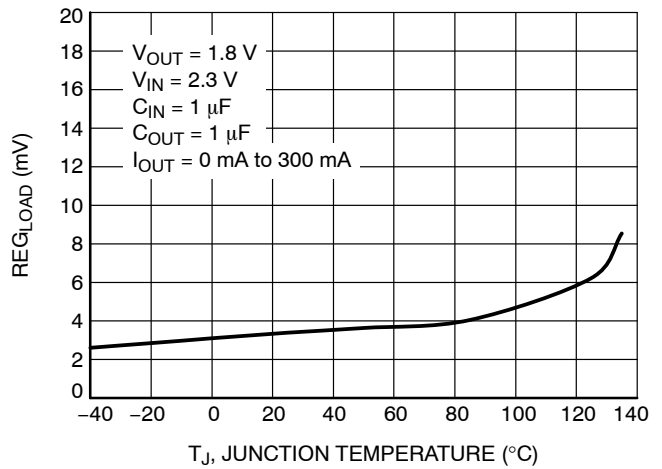

Figure 20. Load Regulation vs. Temperature – 1.8 V

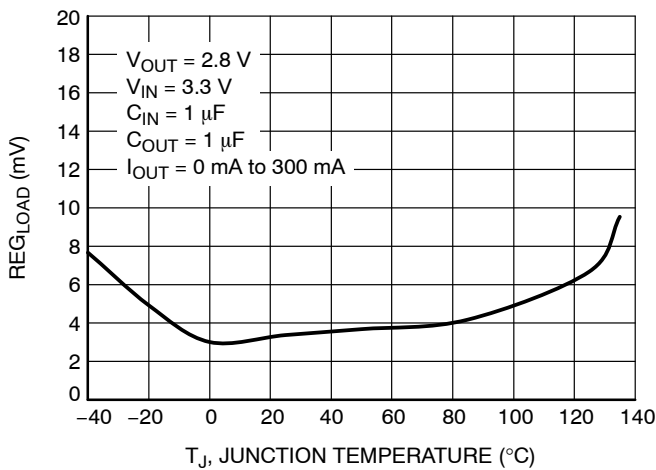

Figure 21. Load Regulation vs. Temperature – 2.8 V

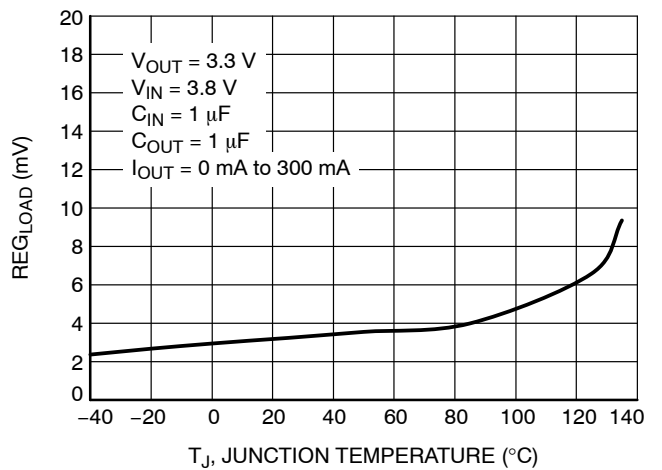

Figure 22. Load Regulation vs. Temperature – 3.3 V

TYPICAL CHARACTERISTICS

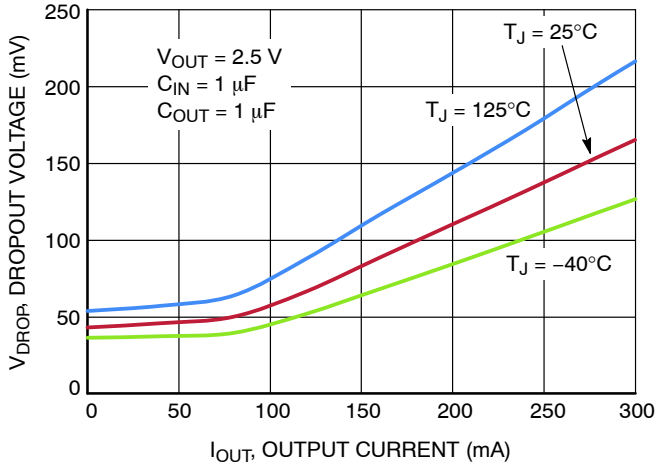

Figure 23. Drop vs. Output Current – 2.5 V

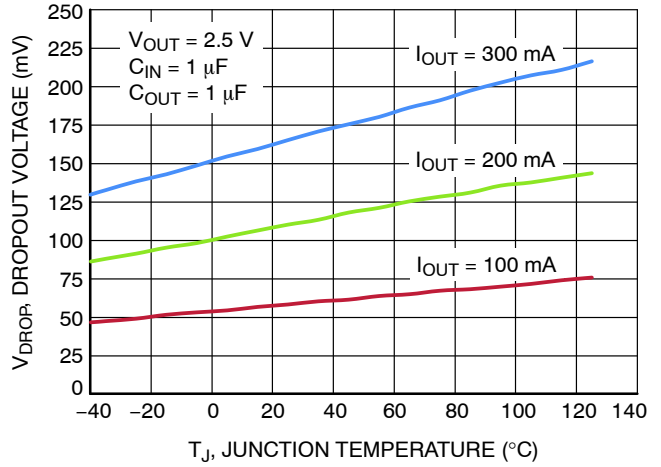

Figure 24. Dropout vs. Temperature – 2.5 V

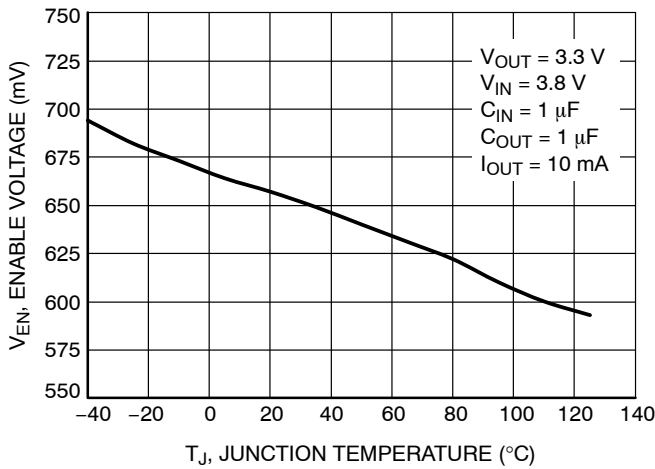

Figure 25. Enable Threshold – High

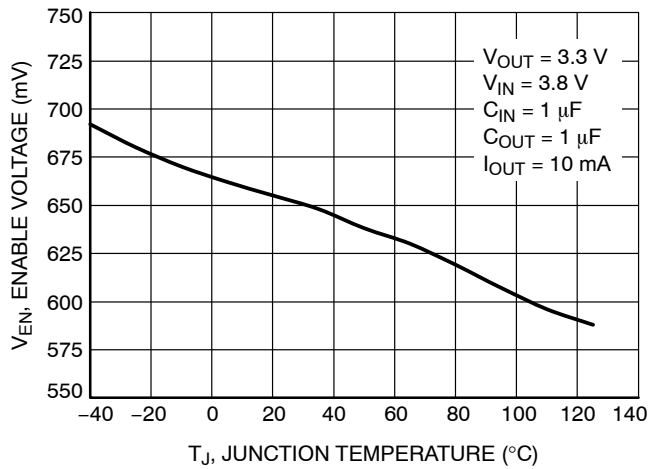

Figure 26. Enable Threshold – Low

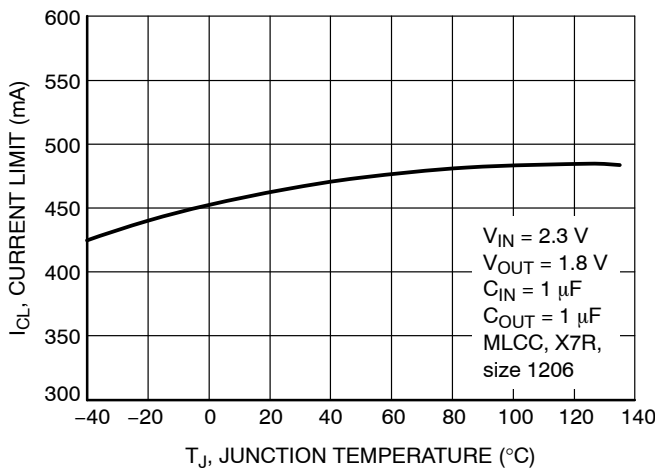

Figure 27. Output Current Limit

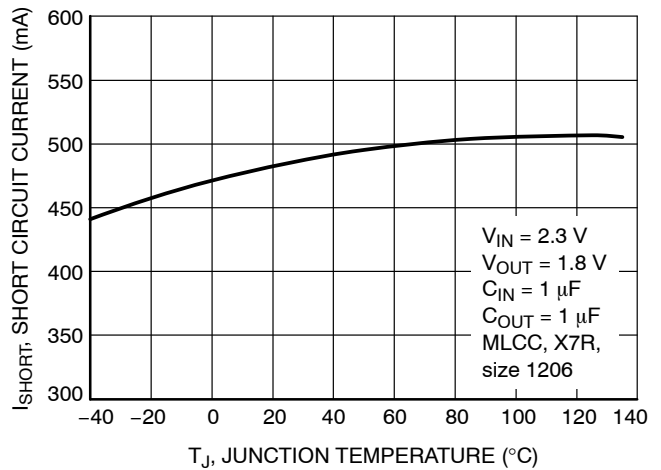

Figure 28. Short Circuit Limit

TYPICAL CHARACTERISTICS

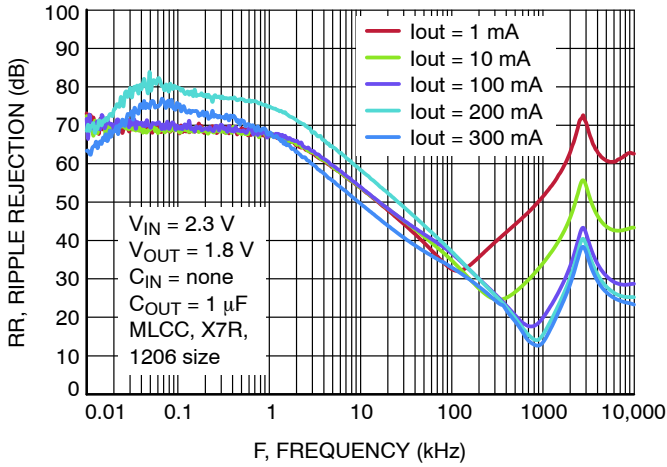

Figure 29. Power Supply Rejection Ratio, $V_{OUT} = 1.8\text{ V}$

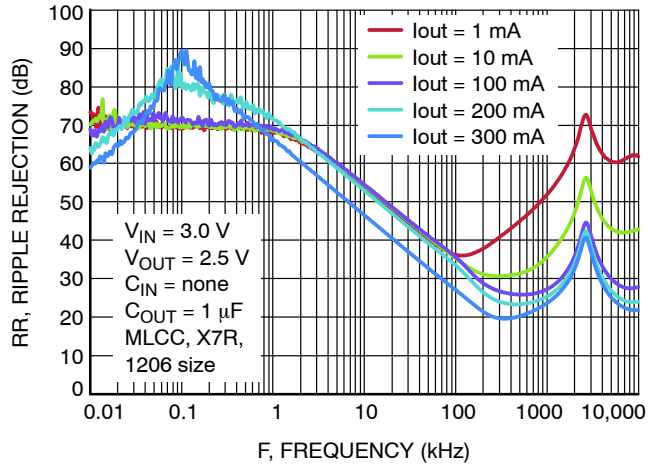

Figure 30. Power Supply Rejection Ratio, $V_{OUT} = 2.5\text{ V}$

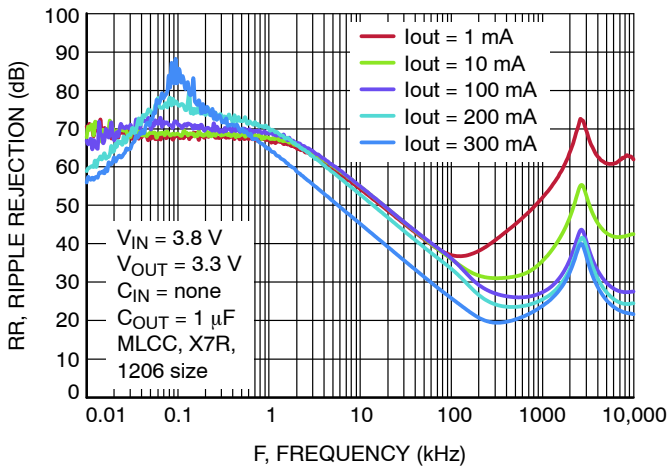

Figure 31. Power Supply Rejection Ratio, $V_{OUT} = 3.3\text{ V}$

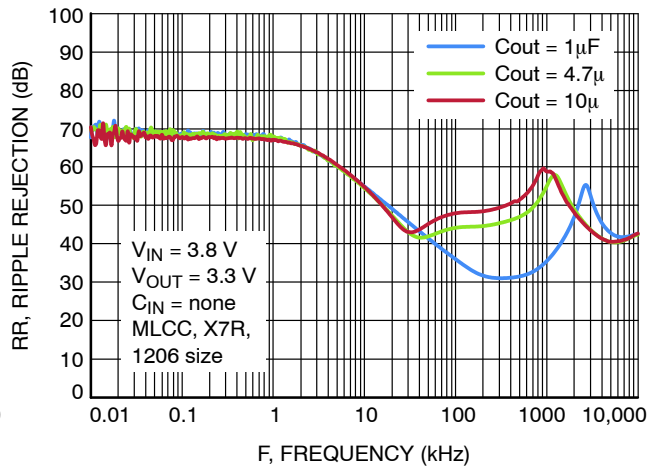

Figure 32. Power Supply Rejection Ratio, $V_{OUT} = 3.3\text{ V}$, $I_{OUT} = 10\text{ mA}$

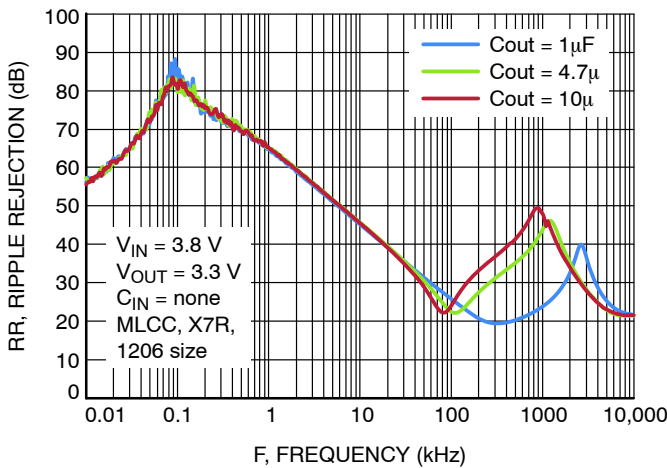

Figure 33. Power Supply Rejection Ratio, $V_{OUT} = 3.3\text{ V}$, $I_{OUT} = 300\text{ mA}$

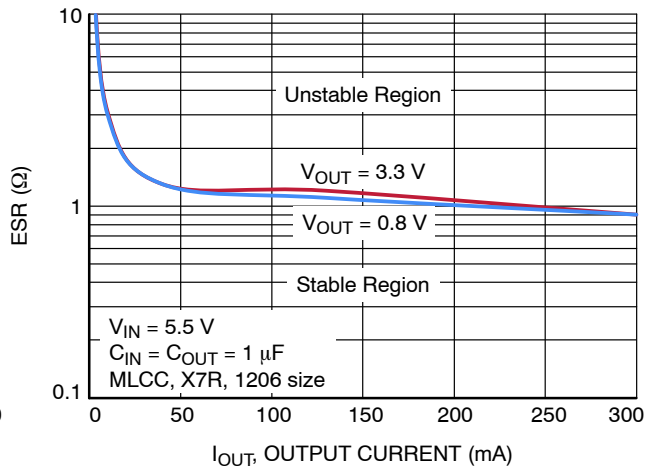

Figure 34. Output Capacitor ESR vs. Output Current

TYPICAL CHARACTERISTICS

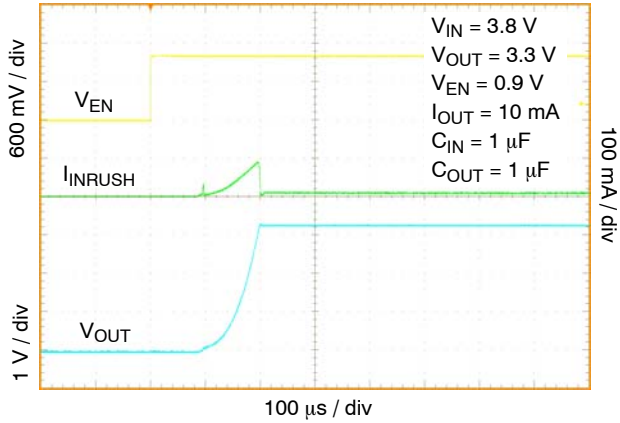

Figure 35. Enable Turn-on Response – $C_{OUT} = 1 \mu F$

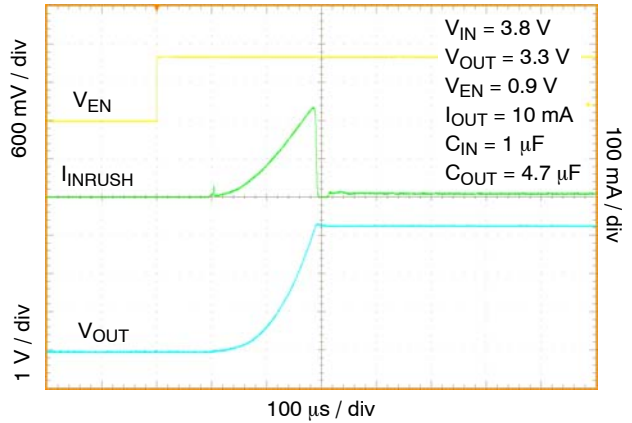

Figure 36. Enable Turn-on Response – $C_{OUT} = 4.7 \mu F$

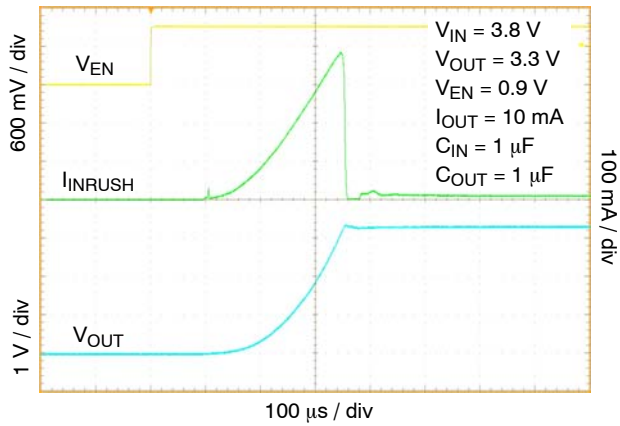

Figure 37. Enable Turn-on Response – $C_{OUT} = 10 \mu F$

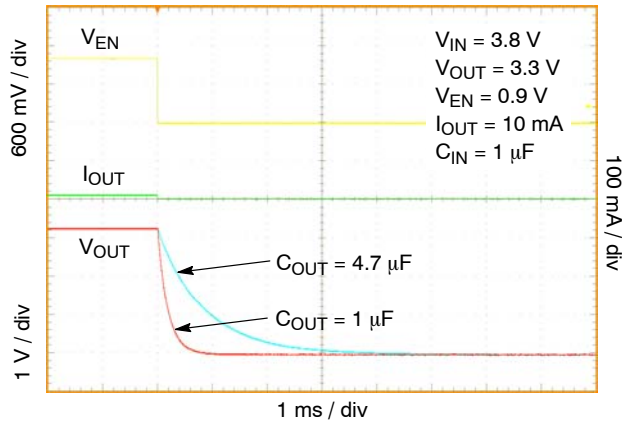

Figure 38. Enable Turn-off Response

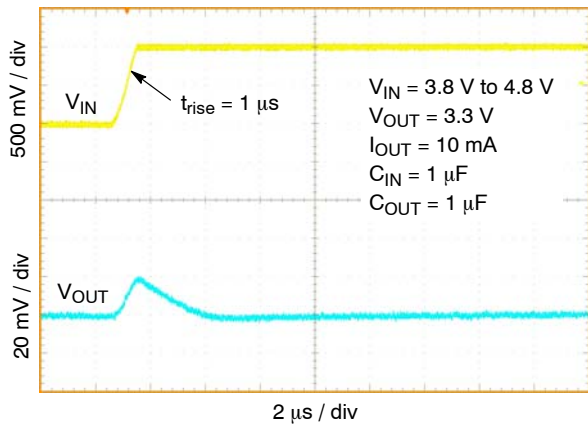

Figure 39. Line Transient Response – Rising Edge, $V_{OUT} = 3.3 V$

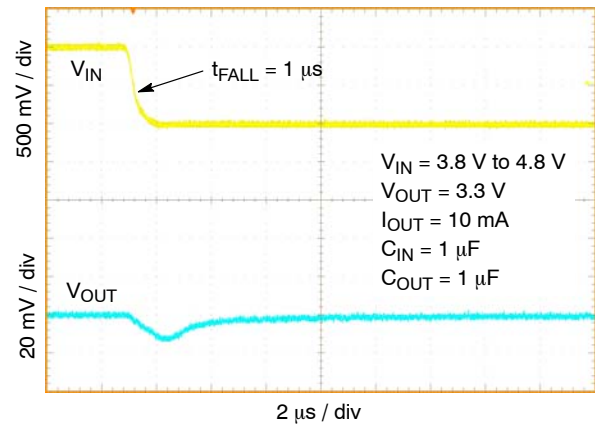

Figure 40. Line Transient Response – Falling Edge, $V_{OUT} = 3.3 V$

TYPICAL CHARACTERISTICS

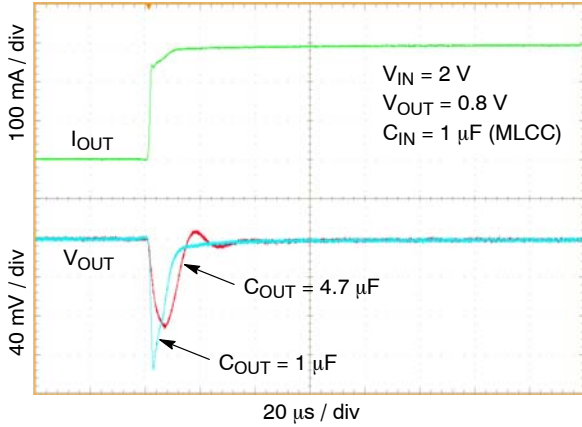

Figure 41. Load Transient Response – Rising Edge, $V_{OUT} = 0.8\text{ V}$, $I_{OUT} = 1\text{ mA}$ to 300 mA , $C_{OUT} = 1\text{ }\mu\text{F}$, $4.7\text{ }\mu\text{F}$

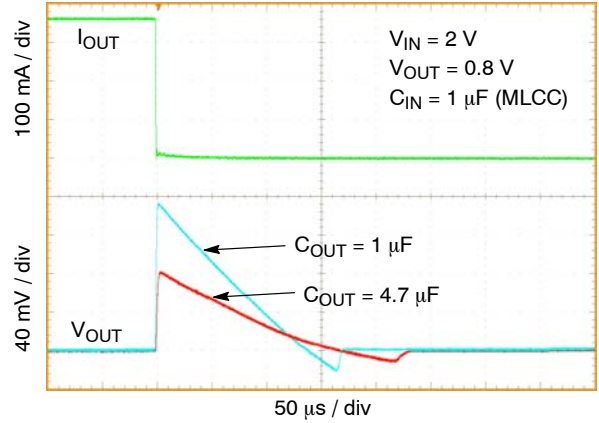

Figure 42. Load Transient Response – Falling Edge, $V_{OUT} = 0.8\text{ V}$, $I_{OUT} = 1\text{ mA}$ to 300 mA , $C_{OUT} = 1\text{ }\mu\text{F}$, $4.7\text{ }\mu\text{F}$

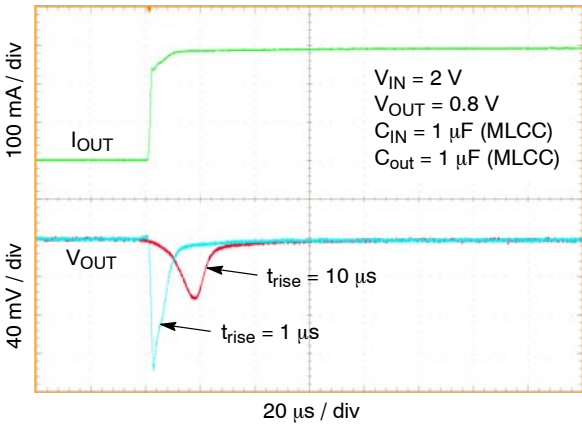

Figure 43. Load Transient Response – Rising Edge, $V_{OUT} = 0.8\text{ V}$, $I_{OUT} = 1\text{ mA}$ to 300 mA , $t_{RISE} = 1\text{ }\mu\text{s}$, $10\text{ }\mu\text{s}$

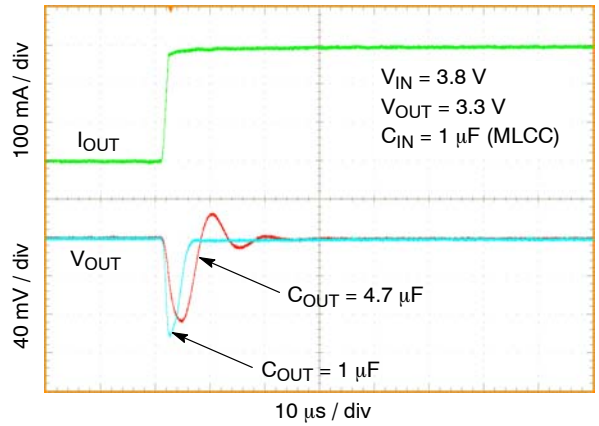

Figure 44. Load Transient Response – Rising Edge, $V_{OUT} = 3.3\text{ V}$, $I_{OUT} = 1\text{ mA}$ to 300 mA , $C_{OUT} = 1\text{ }\mu\text{F}$, $4.7\text{ }\mu\text{F}$

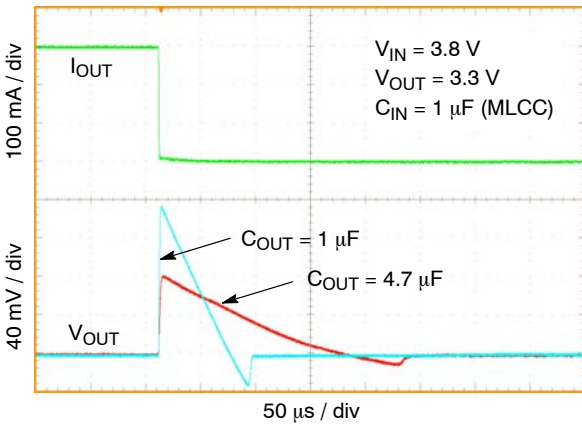

Figure 45. Load Transient Response – Falling Edge, $V_{OUT} = 3.3\text{ V}$, $I_{OUT} = 1\text{ mA}$ to 300 mA , $C_{OUT} = 1\text{ }\mu\text{F}$, $4.7\text{ }\mu\text{F}$

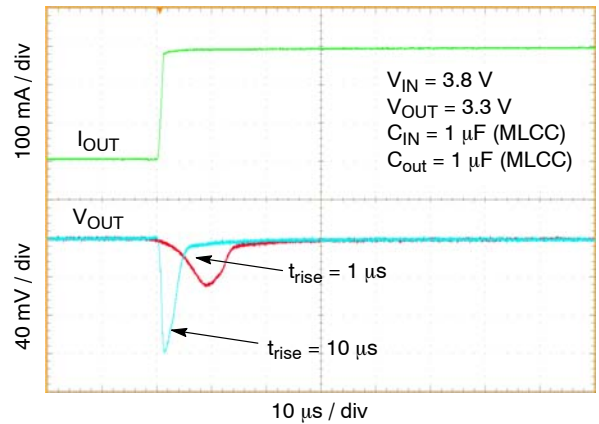

Figure 46. Load Transient Response – Rising Edge, $V_{OUT} = 3.3\text{ V}$, $I_{OUT} = 1\text{ mA}$ to 300 mA , $t_{RISE} = 1\text{ }\mu\text{s}$, $10\text{ }\mu\text{s}$

TYPICAL CHARACTERISTICS

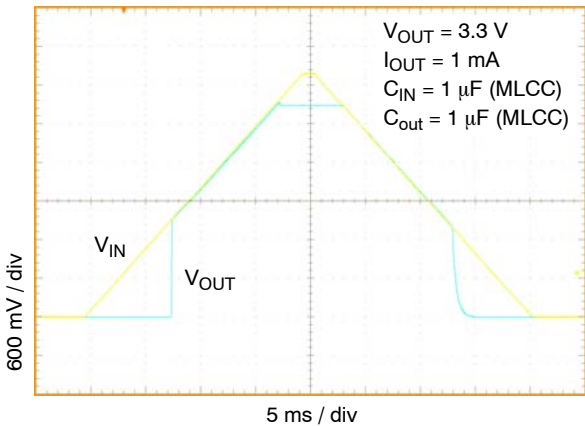

Figure 47. Turn-on/off – Slow Rising V_{IN}

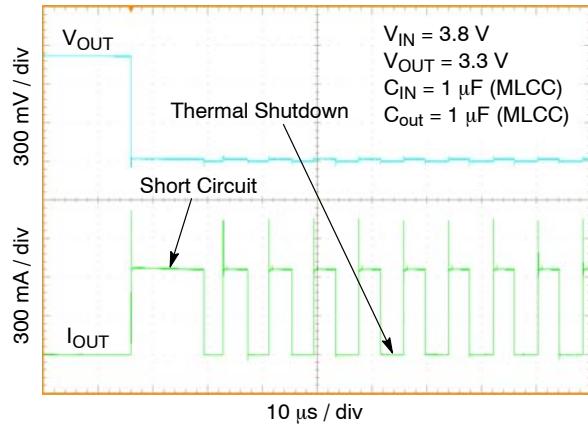

Figure 48. Short Circuit and Thermal Shutdown

APPLICATIONS INFORMATION

General

The NCV8703 is a high performance 300 mA Low Dropout Linear Regulator. This device delivers excellent noise and dynamic performance. Thanks to its adaptive ground current feature the device consumes only 12 μ A of quiescent current at no-load condition. The regulator features ultra-low noise of 13 μ VRMS, PSRR of 68 dB at 1 kHz and very good load/line transient performance. Such excellent dynamic parameters and small package size make the device an ideal choice for powering the precision analog and noise sensitive circuitry in portable applications. The LDO achieves this ultra low noise level output without the need for a noise bypass capacitor. A logic EN input provides ON/OFF control of the output voltage. When the EN is low the device consumes as low as typ. 120 nA from the IN pin. The device is fully protected in case of output overload, output short circuit condition and overheating, assuring a very robust design.

Input Capacitor Selection (CIN)

It is recommended to connect a minimum of 1 μ F Ceramic X5R or X7R capacitor close to the IN pin of the device. This capacitor will provide a low impedance path for unwanted AC signals or noise modulated onto constant input voltage. There is no requirement for the min. /max. ESR of the input capacitor but it is recommended to use ceramic capacitors for their low ESR and ESL. A good input capacitor will limit the influence of input trace inductance and source resistance during sudden load current changes. Larger input capacitor may be necessary if fast and large load transients are encountered in the application.

Output Decoupling (COUT)

The NCV8703 requires an output capacitor connected as close as possible to the output pin of the regulator. The recommended capacitor value is 1 μ F and X7R or X5R dielectric due to its low capacitance variations over the specified temperature range. The NCV8703 is designed to remain stable with minimum effective capacitance of 0.1 μ F to account for changes with temperature, DC bias and package size. Especially for small package size capacitors such as 0402 the effective capacitance drops rapidly with the applied DC bias. Refer to the Figure 49, for the capacitance vs. package size and DC bias voltage dependence.

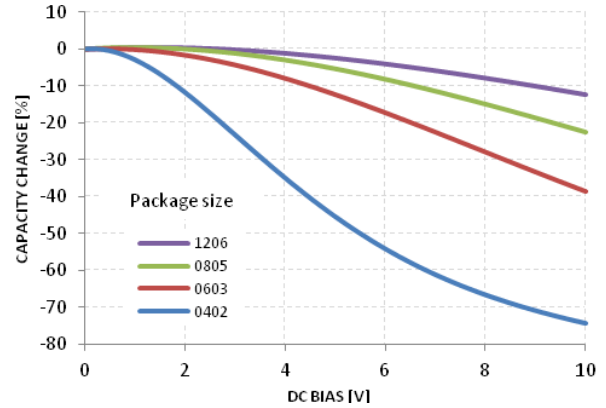

Figure 49. Capacitance Change vs. DC Bias

There is no requirement for the minimum value of Equivalent Series Resistance (ESR) for the C_{OUT} but the maximum value of ESR should be less than 900 m Ω . Larger output capacitors and lower ESR could improve the load transient response or high frequency PSRR as shown in typical characteristics. It is not recommended to use tantalum capacitors on the output due to their large ESR. The equivalent series resistance of tantalum capacitors is also strongly dependent on the temperature, increasing at low temperature. The tantalum capacitors are generally more costly than ceramic capacitors.

No-load Operation

The regulator remains stable and regulates the output voltage properly within the $\pm 2\%$ tolerance limits even with no external load applied to the output.

Enable Operation

The EN pin is used to enable/disable the LDO and to deactivate/activate the active discharge function.

If the EN pin voltage is <0.4 V the device is guaranteed to be disabled. The pass transistor is turned-off so that there is virtually no current flow between the IN and OUT. The active discharge transistor is active so that the output voltage V_{OUT} is pulled to GND through a 320 Ω resistor. In the disable state the device consumes as low as typ. 120 nA from the V_{IN}.

If the EN pin voltage >0.9 V the device is guaranteed to be enabled. The NCV8703 regulates the output voltage and the active discharge transistor is turned-off.

APPLICATIONS INFORMATION

The EN pin has internal pull-down current source with typ. value of 110 nA which assures that the device is turned-off when the EN pin is not connected. Build in 2 mV hysteresis into the EN prevents from periodic on/off oscillations that can occur due to noise.

In the case where the EN function isn't required the EN should be tied directly to IN.

Undervoltage Lockout

The internal UVLO circuitry assures that the device becomes disabled when the V_{IN} falls below typ. 1.5 V. When the V_{IN} voltage ramps-up the NCV8703 becomes enabled, if V_{IN} rises above typ. 1.6 V. The 100 mV hysteresis prevents from on/off oscillations that can occur due to noise on V_{IN} line.

Output Current Limit

Output Current is internally limited within the IC to a typical 490 mA. The NCV8703 will source this amount of current measured when the output voltage drops on the 90% of the nominal V_{OUT} . When the Output Voltage is directly shorted to ground ($V_{OUT} = 0$ V), the short circuit protection will limit the output current to 520 mA (typ). The current limit and short circuit protection will work properly up to $V_{IN} = 5.5$ V at $T_A = 25^\circ\text{C}$. There is no limitation for the short circuit duration.

Internal Soft-Start circuit

NCV8703 contains an internal soft-start circuitry to protect against large inrush currents which could otherwise flow during the start-up of the regulator. Soft-start feature protects against power bus disturbances and assures a controlled and monotonic rise of the output voltage.

Thermal Shutdown

When the die temperature exceeds the Thermal Shutdown threshold ($T_{SD} - 160^\circ\text{C}$ typical), Thermal Shutdown event is detected and the device is disabled. The IC will remain in this state until the die temperature decreases below the Thermal Shutdown Reset threshold ($T_{SDU} - 140^\circ\text{C}$ typical). Once the IC temperature falls below the 140°C the LDO is enabled again. The thermal shutdown feature provides the protection from a catastrophic device failure due to accidental overheating. This protection is not intended to be used as a substitute for proper heat sinking.

Power Dissipation

As power dissipated in the NCV8703 increases, it might become necessary to provide some thermal relief. The maximum power dissipation supported by the device is dependent upon board design and layout. Mounting pad configuration on the PCB, the board material, and the ambient temperature affect the rate of junction temperature rise for the part.

The maximum power dissipation the NCV8703 can handle is given by:

$$P_{D(MAX)} = \frac{[T_{J(MAX)} - T_A]}{\theta_{JA}} \quad (\text{eq. 1})$$

The power dissipated by the NCV8703 for given application conditions can be calculated from the following equations:

$$P_D \approx V_{IN}(I_{GND@I_{OUT}}) + I_{OUT}(V_{IN} - V_{OUT}) \quad (\text{eq. 2})$$

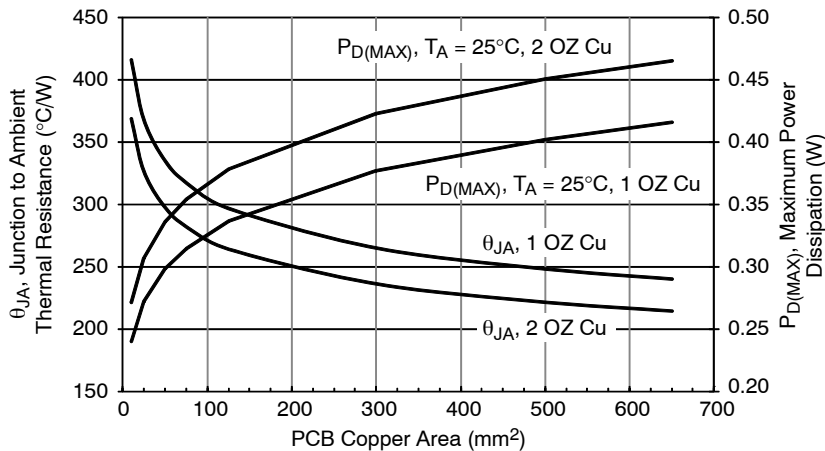

Figure 50. θ_{JA} and $P_{D(MAX)}$ vs. Copper Area (TSOP-5)

APPLICATIONS INFORMATION

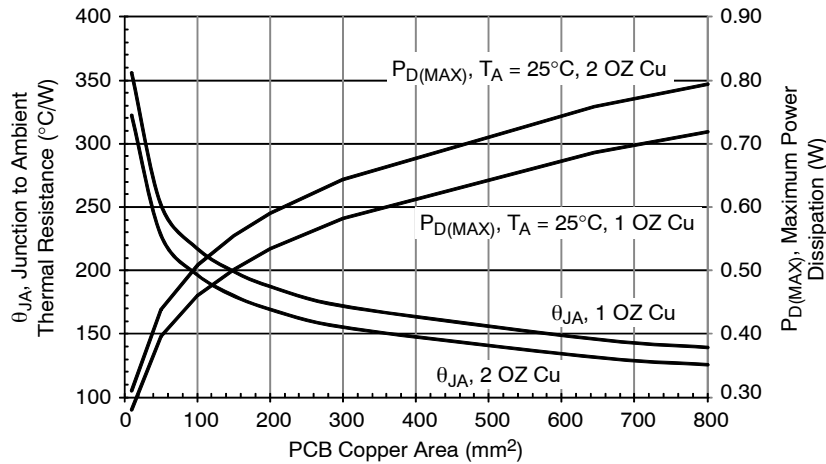

Figure 51. θ_{JA} vs. Copper Area (XDFN6)

Reverse Current

The PMOS pass transistor has an inherent body diode which will be forward biased in the case that $V_{OUT} > V_{IN}$. Due to this fact in cases, where the extended reverse current condition can be anticipated the device may require additional external protection.

Load Regulation

The NCV8703 features very good load regulation of typically 6 mV in 0 mA to 300 mA range. In order to achieve this very good load regulation a special attention to PCB design is necessary. The trace resistance from the OUT pin to the point of load can easily approach 100 mΩ which will cause 30 mV voltage drop at full load current, deteriorating the excellent load regulation.

Line Regulation

The IC features very good line regulation of 0.6 mV/V measured from $V_{IN} = V_{OUT} + 0.5$ V to 5.5 V. For battery operated applications it may be important that the line regulation from $V_{IN} = V_{OUT} + 0.5$ V up to 4.5 V is only 0.45 mV/V.

Power Supply Rejection Ratio

The NCV8703 features very good Power Supply Rejection ratio. If desired the PSRR at higher frequencies in the range 100 kHz – 10 MHz can be tuned by the selection of C_{OUT} capacitor and proper PCB layout.

Output Noise

The IC is designed for ultra-low noise output voltage without external noise filter capacitor (C_{nr}). Figures 3 – 6 shows NCV8703 noise performance. Generally the noise performance in the indicated frequency range improves with increasing output current.

Although even at $I_{OUT} = 1$ mA the noise levels are below 20 μV_{RMS} .

Turn-On Time

The turn-on time is defined as the time period from EN assertion to the point in which V_{OUT} will reach 98% of its nominal value. This time is dependent on various application conditions such as $V_{OUT(NOM)}$, C_{OUT} , T_A .

PCB Layout Recommendations

To obtain good transient performance and good regulation characteristics place C_{IN} and C_{OUT} capacitors close to the device pins and make the PCB traces wide. In order to minimize the solution size, use 0402 capacitors. Larger copper area connected to the pins will also improve the device thermal resistance. The actual power dissipation can be calculated from Equation 2.

NCV8703

ORDERING INFORMATION

Device	Voltage Option	Marking	Package	Shipping †
NCV8703MX18TCG	1.8 V	J	XDFN6	3000 / Tape & Reel
NCV8703MX28TCG	2.8 V	K		
NCV8703MX30TCG	3.0 V	L		
NCV8703MX33TCG	3.3 V	P		
NCV8703SN18T1G	1.8 V	VEC	TSOP5	3000 / Tape & Reel
NCV8703SN28T1G	2.8 V	VED		
NCV8703SN30T1G	3.0 V	VEE		
NCV8703SN33T1G	3.3 V	VEF		

†For information on tape and reel specifications, including part orientation and tape sizes, please refer to our Tape and Reel Packaging Specifications Brochure, BRD8011/D.

NCV8703

PACKAGE DIMENSIONS

XDFN6 1.5x1.5, 0.5P
CASE 711AE
ISSUE O

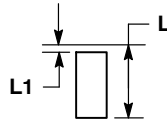
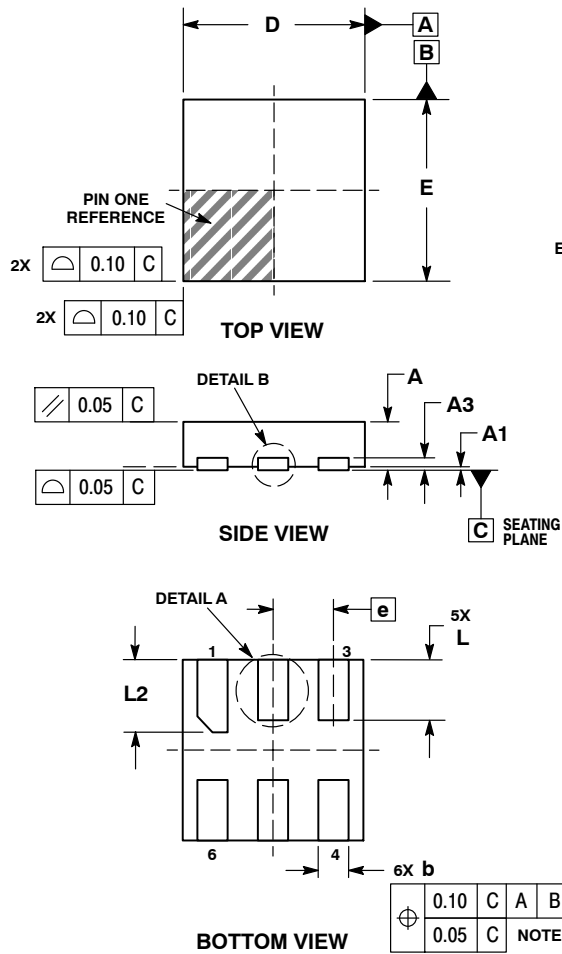

DETAIL A
ALTERNATE TERMINAL
CONSTRUCTIONS

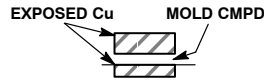

DETAIL B
ALTERNATE
CONSTRUCTIONS

- NOTES:
1. DIMENSIONING AND TOLERANCING PER ASME Y14.5M, 1994.
 2. CONTROLLING DIMENSION: MILLIMETERS.
 3. DIMENSION b APPLIES TO PLATED TERMINAL AND IS MEASURED BETWEEN 0.10 AND 0.20mm FROM TERMINAL TIP.

MILLIMETERS		
DIM	MIN	MAX
A	0.35	0.45
A1	0.00	0.05
A3	0.13 REF	
b	0.20	0.30
D	1.50 BSC	
E	1.50 BSC	
e	0.50 BSC	
L	0.40	0.60
L1	---	0.15
L2	0.50	0.70

RECOMMENDED MOUNTING FOOTPRINT*

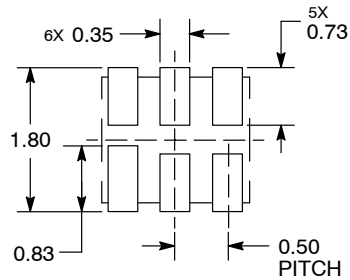

DIMENSIONS: MILLIMETERS

*For additional information on our Pb-Free strategy and soldering details, please download the ON Semiconductor Soldering and Mounting Techniques Reference Manual, SOLDERRM/D.

NCV8703

PACKAGE DIMENSIONS

TSOP-5 CASE 483-02 ISSUE H

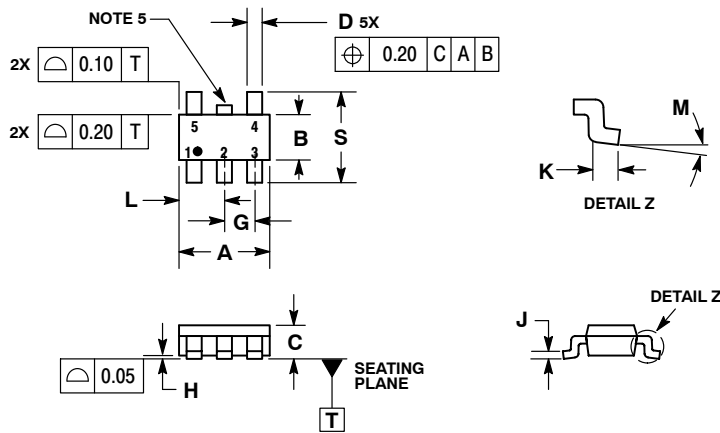

NOTES:

1. DIMENSIONING AND TOLERANCING PER ASME Y14.5M, 1994.
2. CONTROLLING DIMENSION: MILLIMETERS.
3. MAXIMUM LEAD THICKNESS INCLUDES LEAD FINISH THICKNESS. MINIMUM LEAD THICKNESS IS THE MINIMUM THICKNESS OF BASE MATERIAL.
4. DIMENSIONS A AND B DO NOT INCLUDE MOLD FLASH, PROTRUSIONS, OR GATE BURRS.
5. OPTIONAL CONSTRUCTION: AN ADDITIONAL TRIMMED LEAD IS ALLOWED IN THIS LOCATION. TRIMMED LEAD NOT TO EXTEND MORE THAN 0.2 FROM BODY.

DIM	MILLIMETERS	
	MIN	MAX
A	3.00 BSC	
B	1.50 BSC	
C	0.90	1.10
D	0.25	0.50
G	0.95 BSC	
H	0.01	0.10
J	0.10	0.26
K	0.20	0.60
L	1.25	1.55
M	0° 10°	
S	2.50	3.00

SOLDERING FOOTPRINT*

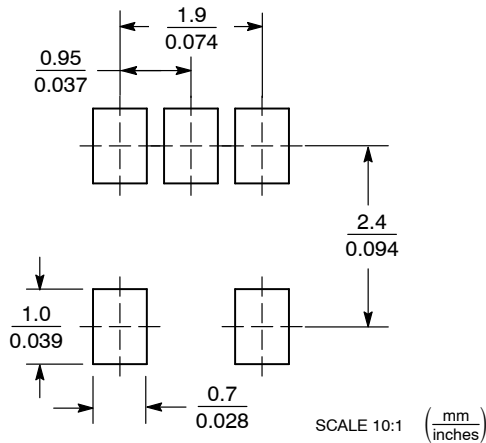

*For additional information on our Pb-Free strategy and soldering details, please download the ON Semiconductor Soldering and Mounting Techniques Reference Manual, SOLDERRM/D.

ON Semiconductor and are registered trademarks of Semiconductor Components Industries, LLC (SCILLC). SCILLC owns the rights to a number of patents, trademarks, copyrights, trade secrets, and other intellectual property. A listing of SCILLC's product/patent coverage may be accessed at www.onsemi.com/site/pdf/Patent-Marking.pdf. SCILLC reserves the right to make changes without further notice to any products herein. SCILLC makes no warranty, representation or guarantee regarding the suitability of its products for any particular purpose, nor does SCILLC assume any liability arising out of the application or use of any product or circuit, and specifically disclaims any and all liability, including without limitation special, consequential or incidental damages. "Typical" parameters which may be provided in SCILLC data sheets and/or specifications can and do vary in different applications and actual performance may vary over time. All operating parameters, including "Typicals" must be validated for each customer application by customer's technical experts. SCILLC does not convey any license under its patent rights nor the rights of others. SCILLC products are not designed, intended, or authorized for use as components in systems intended for surgical implant into the body, or other applications intended to support or sustain life, or for any other application in which the failure of the SCILLC product could create a situation where personal injury or death may occur. Should Buyer purchase or use SCILLC products for any such unintended or unauthorized application, Buyer shall indemnify and hold SCILLC and its officers, employees, subsidiaries, affiliates, and distributors harmless against all claims, costs, damages, and expenses, and reasonable attorney fees arising out of, directly or indirectly, any claim of personal injury or death associated with such unintended or unauthorized use, even if such claim alleges that SCILLC was negligent regarding the design or manufacture of the part. SCILLC is an Equal Opportunity/Affirmative Action Employer. This literature is subject to all applicable copyright laws and is not for resale in any manner.

PUBLICATION ORDERING INFORMATION

LITERATURE FULFILLMENT:

Literature Distribution Center for ON Semiconductor
P.O. Box 5163, Denver, Colorado 80217 USA
Phone: 303-675-2175 or 800-344-3860 Toll Free USA/Canada
Fax: 303-675-2176 or 800-344-3867 Toll Free USA/Canada
Email: orderlit@onsemi.com

N. American Technical Support: 800-282-9855 Toll Free
USA/Canada
Europe, Middle East and Africa Technical Support:
Phone: 421 33 790 2910
Japan Customer Focus Center
Phone: 81-3-5817-1050

ON Semiconductor Website: www.onsemi.com

Order Literature: <http://www.onsemi.com/orderlit>

For additional information, please contact your local Sales Representative

Компания «Океан Электроники» предлагает заключение долгосрочных отношений при поставках импортных электронных компонентов на взаимовыгодных условиях!

Наши преимущества:

- Поставка оригинальных импортных электронных компонентов напрямую с производств Америки, Европы и Азии, а так же с крупнейших складов мира;
- Широкая линейка поставок активных и пассивных импортных электронных компонентов (более 30 млн. наименований);
- Поставка сложных, дефицитных, либо снятых с производства позиций;
- Оперативные сроки поставки под заказ (от 5 рабочих дней);
- Экспресс доставка в любую точку России;
- Помощь Конструкторского Отдела и консультации квалифицированных инженеров;
- Техническая поддержка проекта, помощь в подборе аналогов, поставка прототипов;
- Поставка электронных компонентов под контролем ВП;
- Система менеджмента качества сертифицирована по Международному стандарту ISO 9001;
- При необходимости вся продукция военного и аэрокосмического назначения проходит испытания и сертификацию в лаборатории (по согласованию с заказчиком);
- Поставка специализированных компонентов военного и аэрокосмического уровня качества (Xilinx, Altera, Analog Devices, Intersil, Interpoint, Microsemi, Actel, Aeroflex, Peregrine, VPT, Syfer, Eurofarad, Texas Instruments, MS Kennedy, Miteq, Cobham, E2V, MA-COM, Hittite, Mini-Circuits, General Dynamics и др.);

Компания «Океан Электроники» является официальным дистрибьютором и эксклюзивным представителем в России одного из крупнейших производителей разъемов военного и аэрокосмического назначения «JONHON», а так же официальным дистрибьютором и эксклюзивным представителем в России производителя высокотехнологичных и надежных решений для передачи СВЧ сигналов «FORSTAR».



JONHON

«JONHON» (основан в 1970 г.)

Разъемы специального, военного и аэрокосмического назначения:

(Применяются в военной, авиационной, аэрокосмической, морской, железнодорожной, горно- и нефтедобывающей отраслях промышленности)

«FORSTAR» (основан в 1998 г.)

ВЧ соединители, коаксиальные кабели, кабельные сборки и микроволновые компоненты:

(Применяются в телекоммуникациях гражданского и специального назначения, в средствах связи, РЛС, а так же военной, авиационной и аэрокосмической отраслях промышленности).



Телефон: 8 (812) 309-75-97 (многоканальный)

Факс: 8 (812) 320-03-32

Электронная почта: ocean@oceanchips.ru

Web: <http://oceanchips.ru/>

Адрес: 198099, г. Санкт-Петербург, ул. Калинина, д. 2, корп. 4, лит. А