



# TAOGLAS®



# Datasheet

## Taoglas Reach Series - PCS.66.A

### Description:

Reach Low Profile Wideband 5G/4G SMD Antenna

### Features:

- Patent Pending Innovative Design
- High Efficiency Wideband Antenna, Covering 600 to 6000 MHz
- Supporting 5G FR1 Bands
- 600 MHz 5G/4G Band 71 Support
- Backwards Compatible with all 3G/2G applications
- Surface Mount Distribution – Supplied on Tape & Reel
- Dimensions: 32 x 25 x 1.6 mm
- RoHS & REACH Compliant

1.	Introduction	3
2.	Specifications	5
3.	Antenna Characteristics	6
4.	2D Radiation Patterns	9
5.	3D Radiation Patterns	12
6.	Mechanical Drawing	17
7.	Layout Dimensions	18
8.	EVB Dimensions	19
9.	Matching Circuit	20
10.	Packaging	21
	Changelog	22

Taoglas makes no warranties based on the accuracy or completeness of the contents of this document and reserves the right to make changes to specifications and product descriptions at any time without notice. Taoglas reserves all rights to this document and the information contained herein. Reproduction, use or disclosure to third parties without express permission is strictly prohibited.



## 1. Introduction

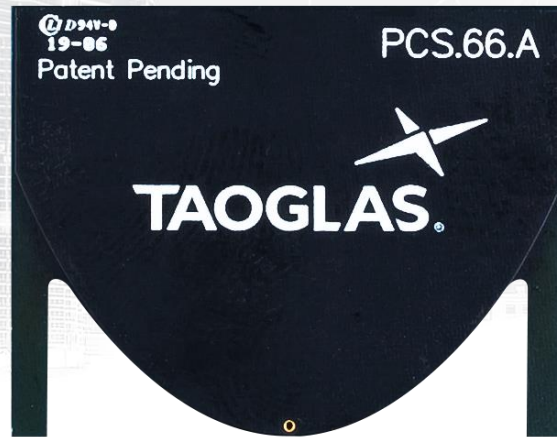

The Taoglas Reach series, are a revolutionary, low profile, small footprint, range of patent pending SMD mount PCB wide-band antennas. The PCS.66.A has been designed to cover all 5G bands, including all sub-6GHz deployments across the 600MHz to 6000MHz spectrum on a very small footprint of just 32 x 25mm. It also covers 3G and 2G bands to allow for fall-back when 5G/4G is not available.

The patent pending design uses printed circuit board material and innovative design techniques to deliver the highest efficiencies at all bands when mounted on the device's main PCB. The PCS.66.A is suitable for lower cost 5G/4G applications, especially IoT projects requiring wide bandwidth and comes supplied on tape and reel to allow it be mounted via 'pick & place' onto the PCB.

If tuning is required, it can also be tuned specifically depending on device environment. If PCB space is an issue, the Reach PCS.86, covering 791 – 6000MHz, could be an option with an even smaller footprint of just 32 x 16mm. Contact your local Taoglas customer support team for advice on integrating the Reach into your device.

## 1.1 Key Advantages

### 1. Highest efficiency in small footprint

A comparative antenna to the Reach, for example, metal/ceramic/FPC, would have much-reduced efficiency in this configuration due to their high substrate loss at high frequencies. Very high efficiency antennas are critical to 4G and 5G devices ability to deliver the stated data-speed rates of systems such as 5G and 4G.

### 2. Low profile

Many antennas require a large keep-out area in addition to the mechanical size to work correctly, which limits the usable PCB space. The Reach requires only .3 mm of additional keep-out, allowing board designers to maximize their PCB space.

### 3. Adaptable

The high radiation efficiency of the Reach over its entire operating bandwidth means that the total efficiency is only limited by the impedance mismatch loss. As a result, this antenna can be optimized via a matching network to the specific bands needed for any application. Efficiencies as high as 90% have been measured when the return loss is very high (-15 dB or more).

### 4. More resistant to detuning compared to other antenna integrations

If tuning is required it can be tuned for the device environment using a matching circuit, or other techniques on the main PCB itself. There is no need for new tooling, thereby saving money if customization is required.

### 5. Surface Mount Distribution (SMD)

Direct mount, 'on-board' antennas save on labor, cable and connector costs, leads to higher integration yield rates and reduces losses in transmission.

### 6. Minimum Transmission and Reception Losses

These are kept to an absolute minimum resulting in much improved OTA (over the air), i.e. TRP (Total Radiated Power) / TIS (Total Isotropic Radiation), device performance compared to similar efficiency cable and connector antenna solutions. This means it is an ideal antenna to be used for devices that need to pass for example USA carrier network approvals.

## 2. Specifications

### Electrical

Standard	5G NR Band 71/LTE/GSM/CDMA	5G NR Band 74,75,76	LTE/GSM/HSPA/CDMA	UMTS/HSPA	Wi-Fi 2400	LTE 2600	5G NR Band 77,78,79	Wi-Fi 5800
Operation Frequency (MHz)	617-960	1427-1518	1710-1990	1920-2170	2400-2500	2500-2700	3300-5000	5150-5850
Peak Gain	1.3 dBi	2.5 dBi	3.2 dBi	3.5 dBi	3.5 dBi	5.7 dBi	5.5 dBi	3.5 dBi
Average Gain	-2.6 dB	-3.3 dB	-1.6 dB	-1.7 dB	-2 dB	-1.5 dB	-1 dB	-3.4 dB
Efficiency	55%	46%	69%	68%	63%	70%	80%	45%
VSWR	<3.0:1							
Impedance	50Ω							
Polarization	Linear							
Radiation Properties	Omni-directional							
Max Input Power	5 W							

The Reach PCS.66.A antenna performance was measured on a 107x32 ground plane

### Mechanical

Dimensions	32mm x 25mm x 1.6mm
Material	PCB
Termination	Solder Pad
EVB Connector	SMA-Female

### Environmental

Operation Temperature	-40°C to 85°C
Storage Temperature	-40°C to 105°C
Relative Humidity	Non-condensing 65°C 95% RH
RoHs & REACH Compliant	Yes

### 3. Antenna Characteristics

#### 3.1 Test Setup

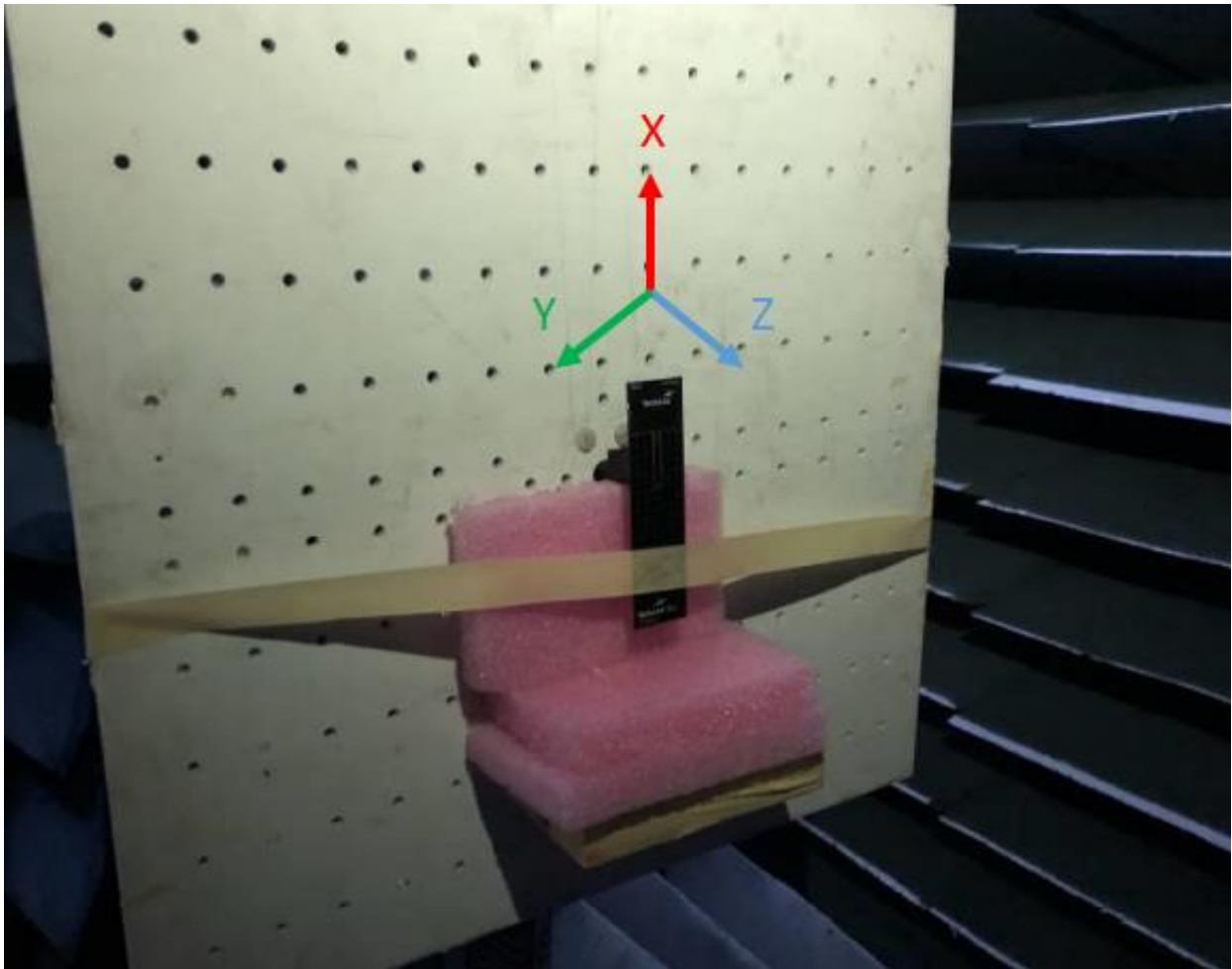

On Evaluation Board

### 3.2 Return Loss

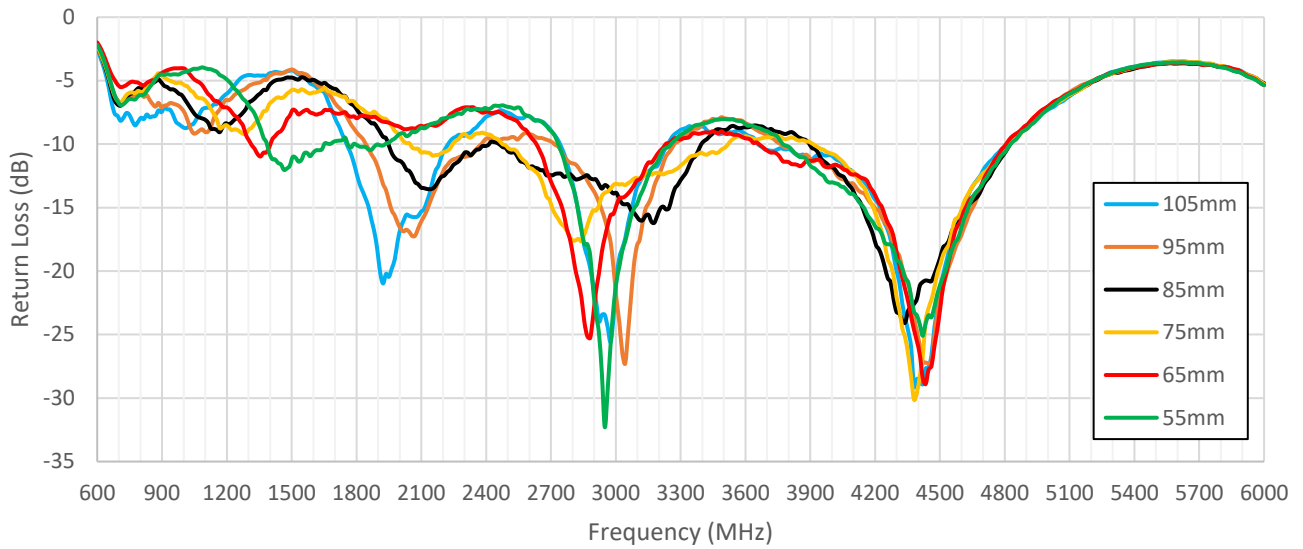

### 3.3 VSWR

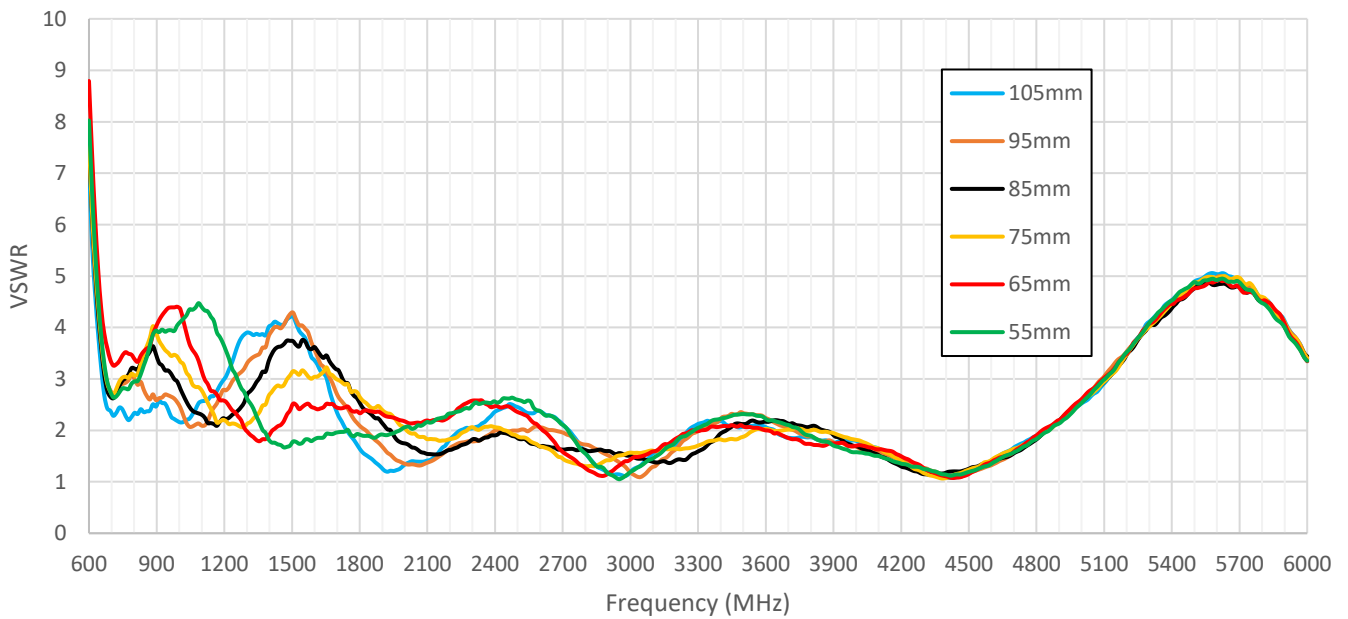

### 3.4 Efficiency

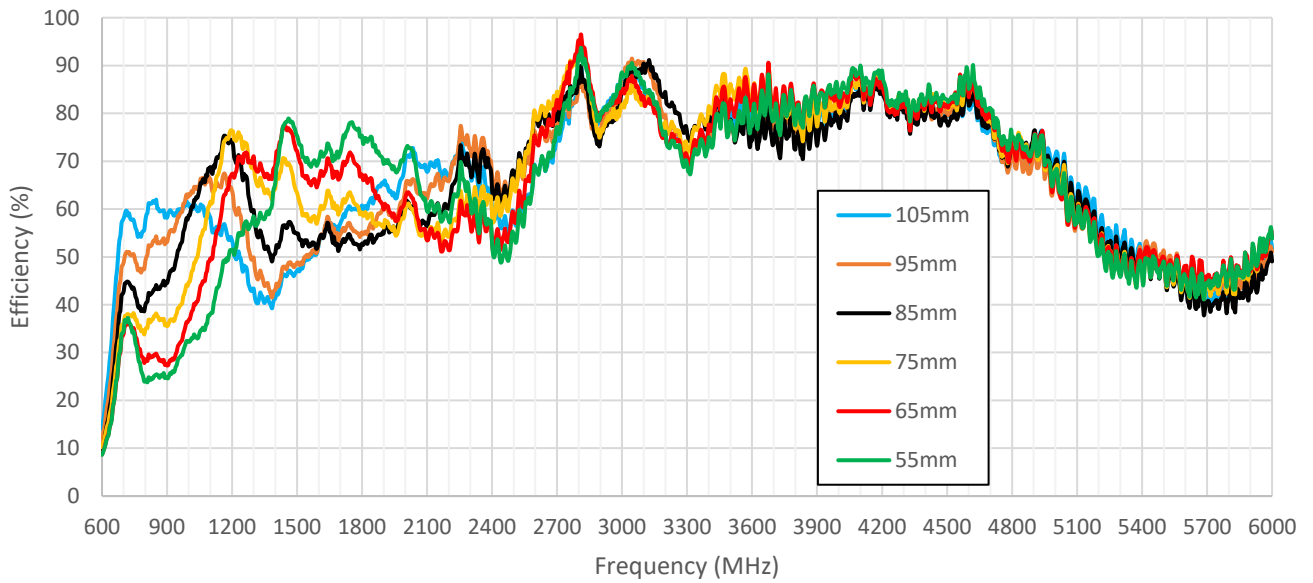

### 3.5 Peak Gain

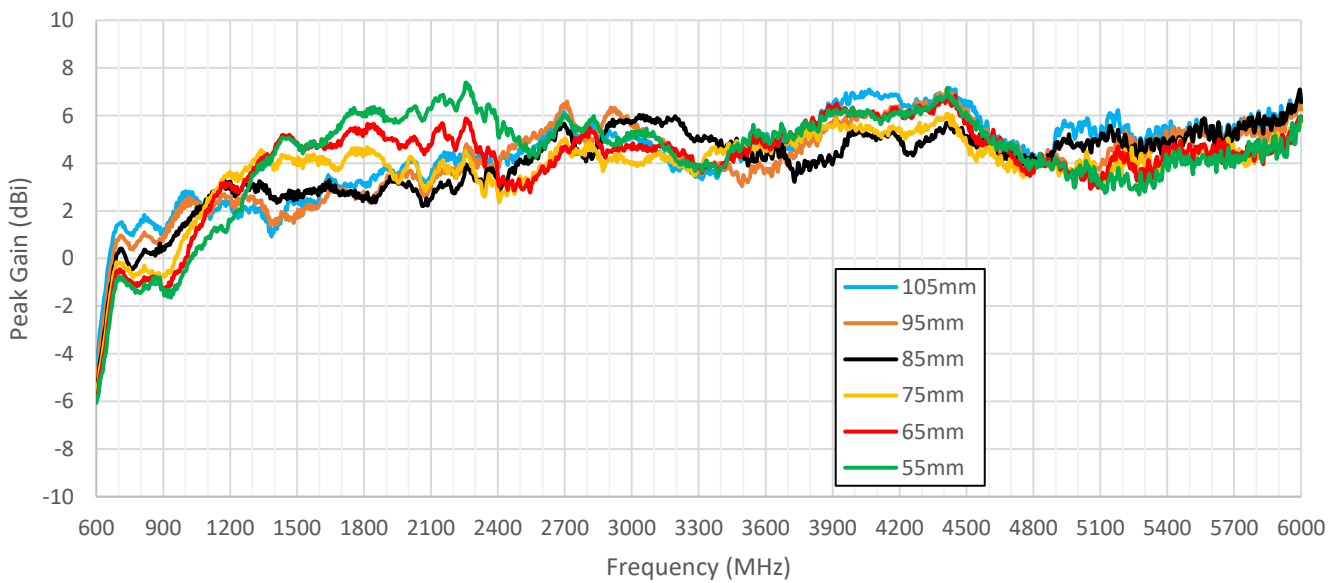



### 3.6 Average Gain

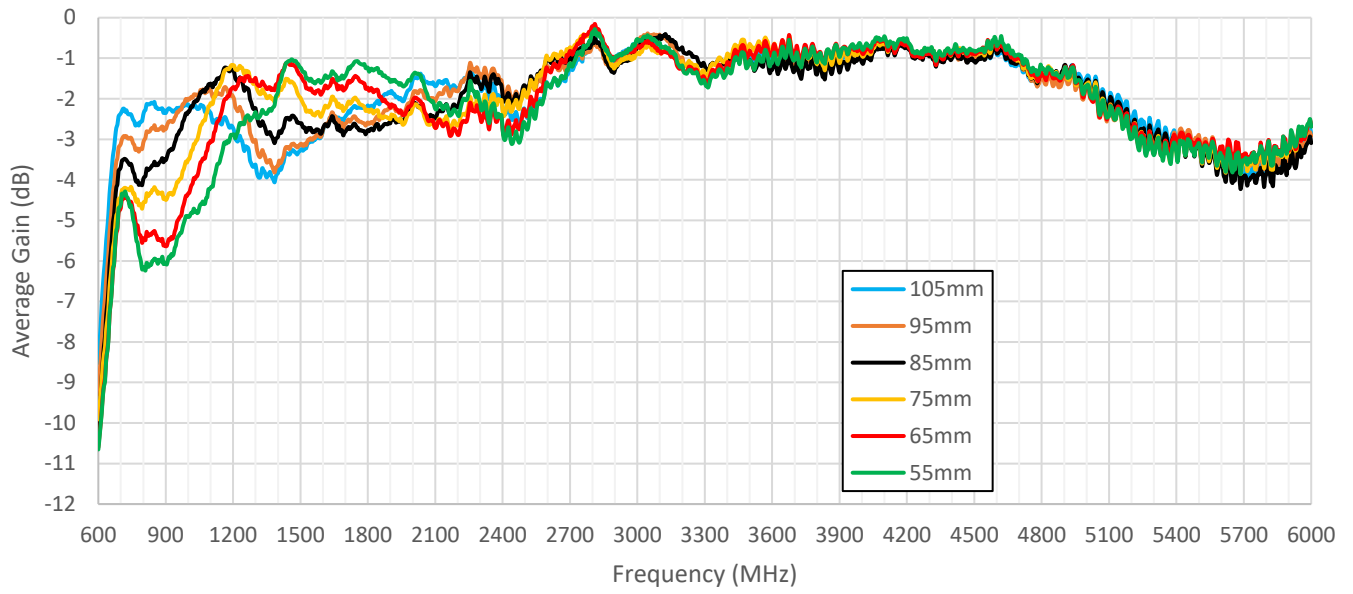

# 4. 2D Radiation Patterns (Measured on 130\*32mm EVB)

XY Plane

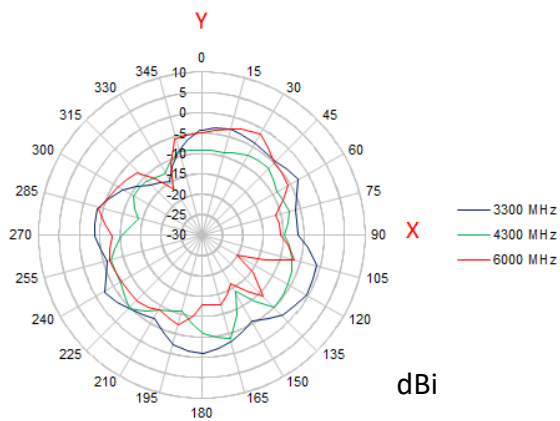
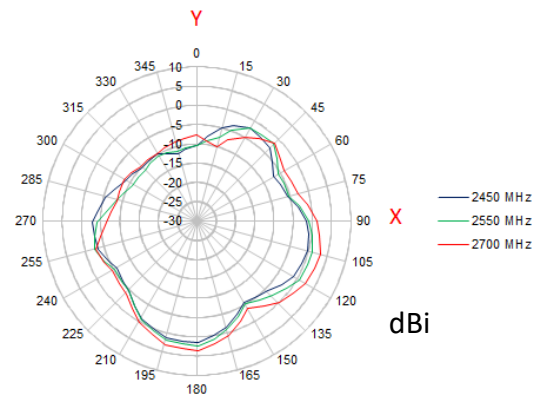
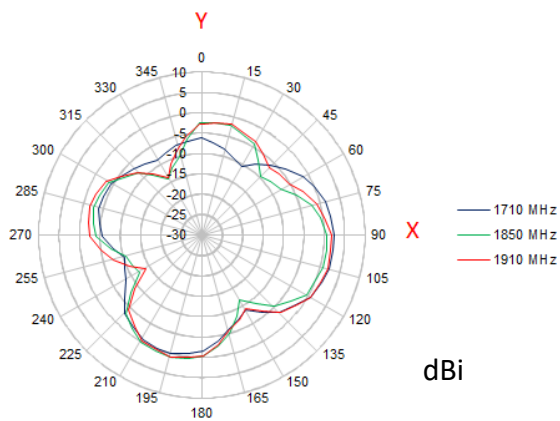
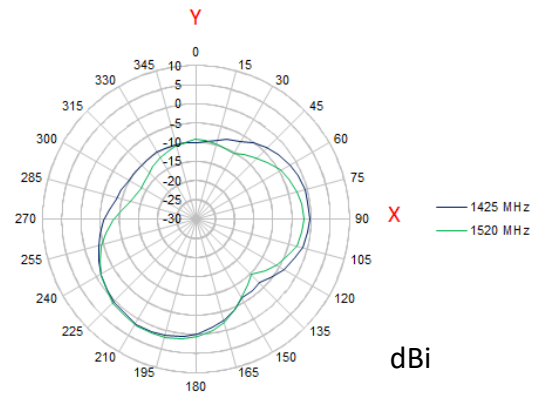
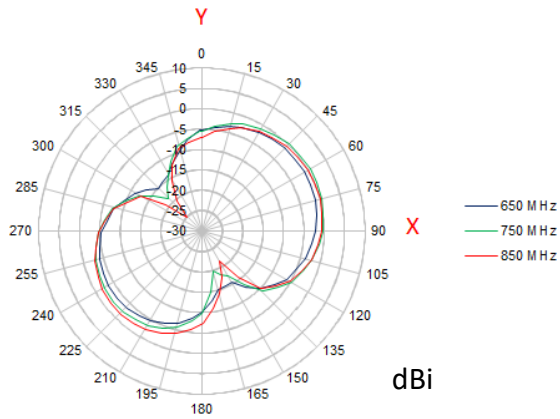

YZ Plane

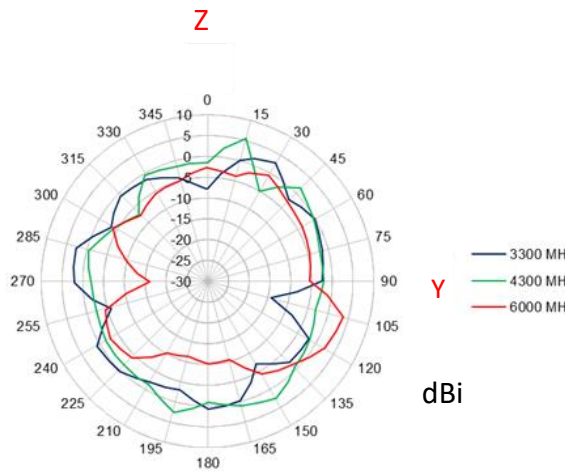
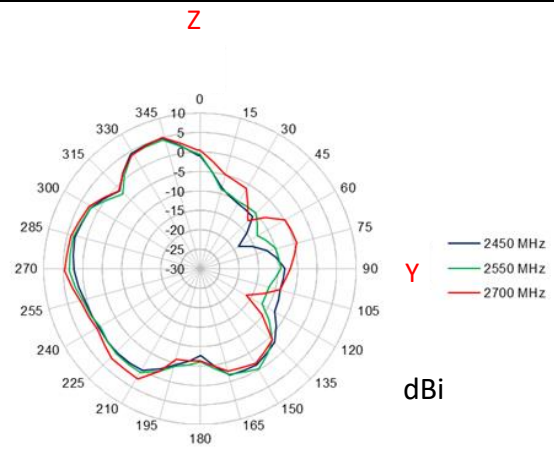
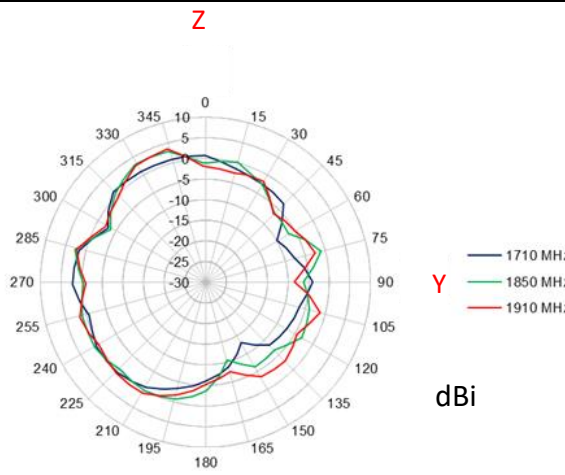
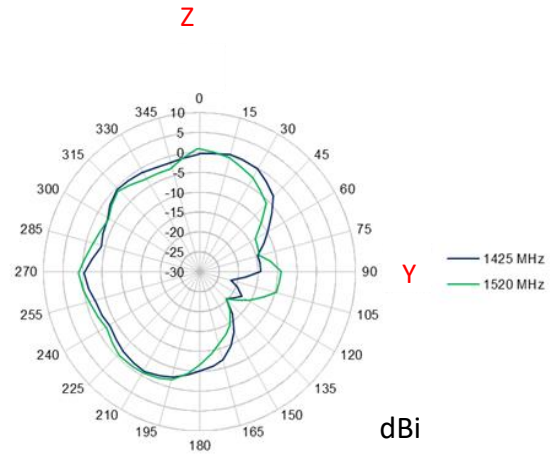
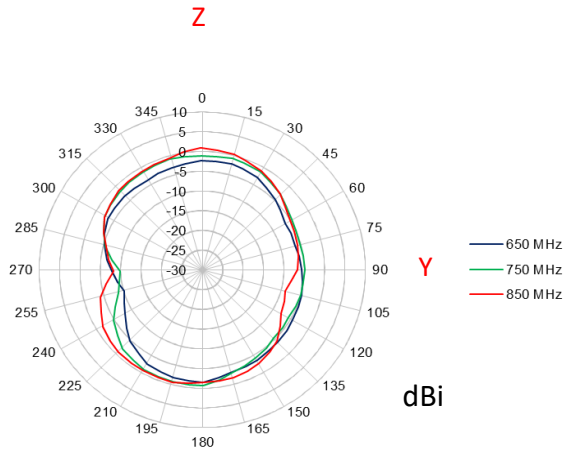

XZ Plane

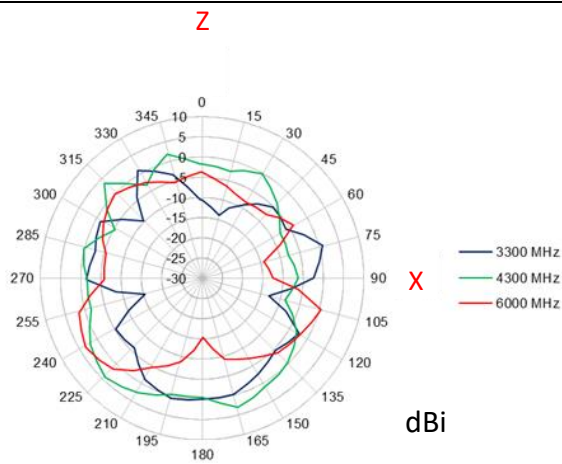
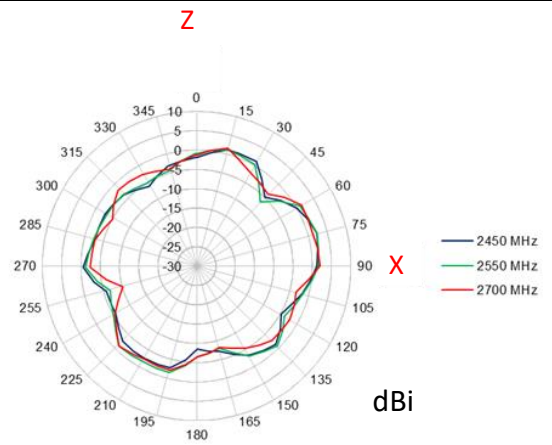
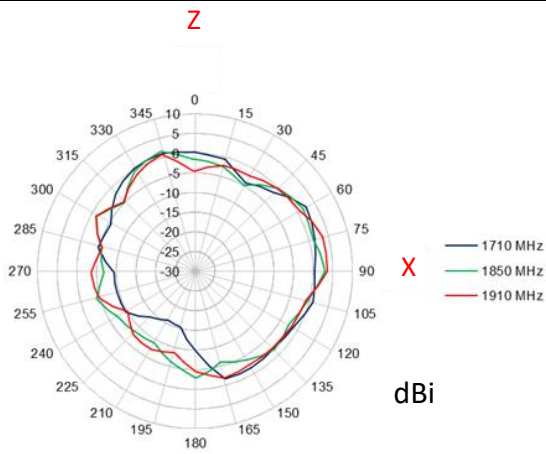
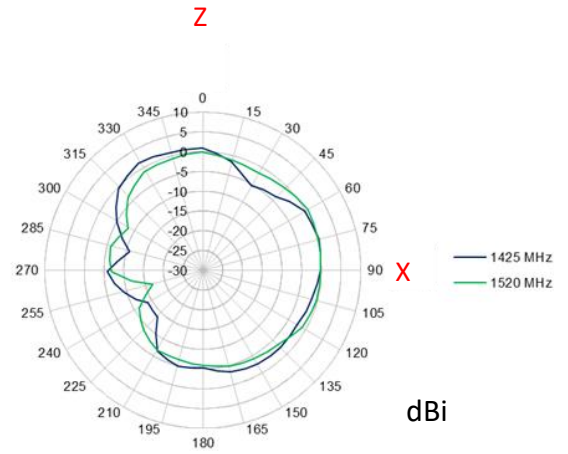
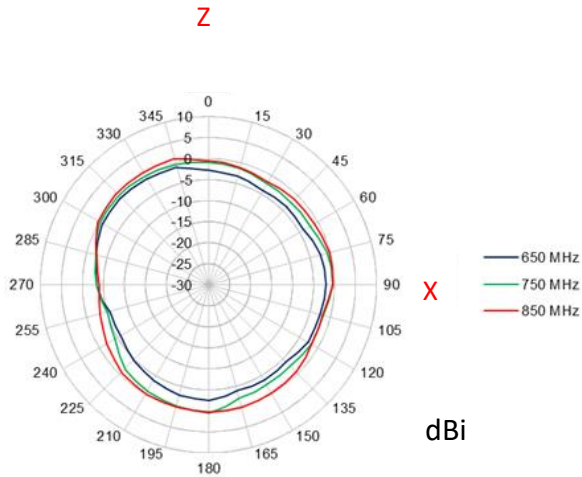

# 5. 3D Radiation Patterns

## 5.1 132\*32mm EVB

650 MHz

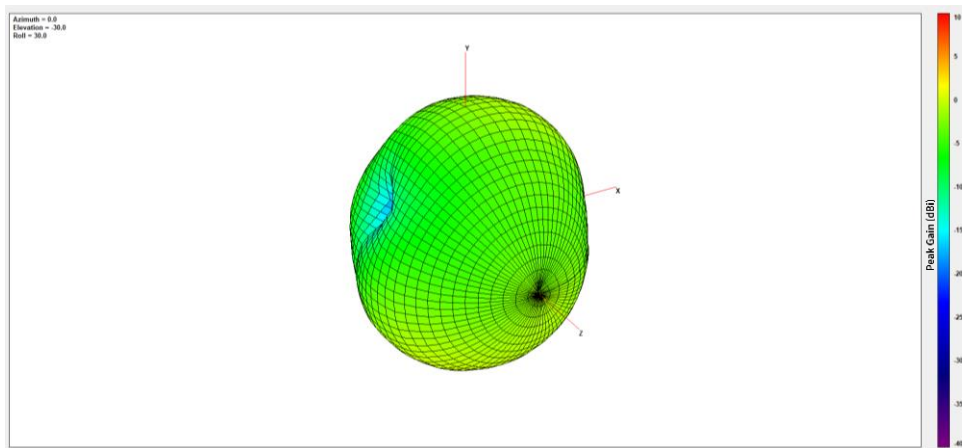

750 MHz

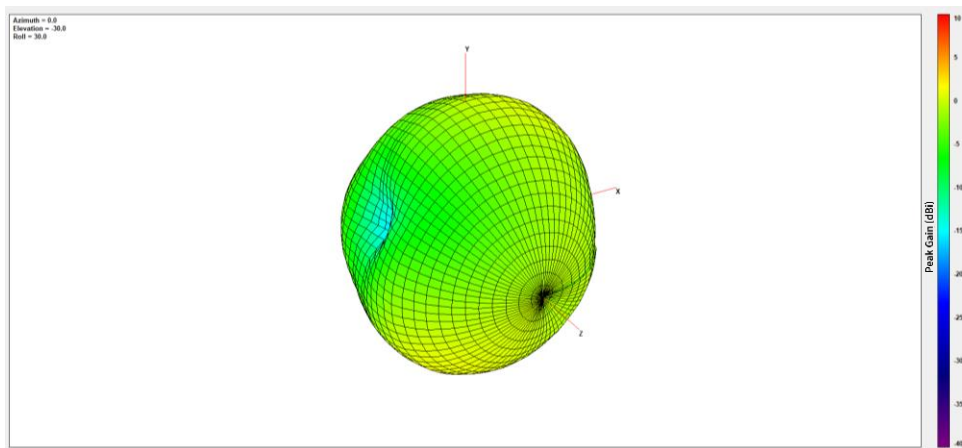

850 MHz

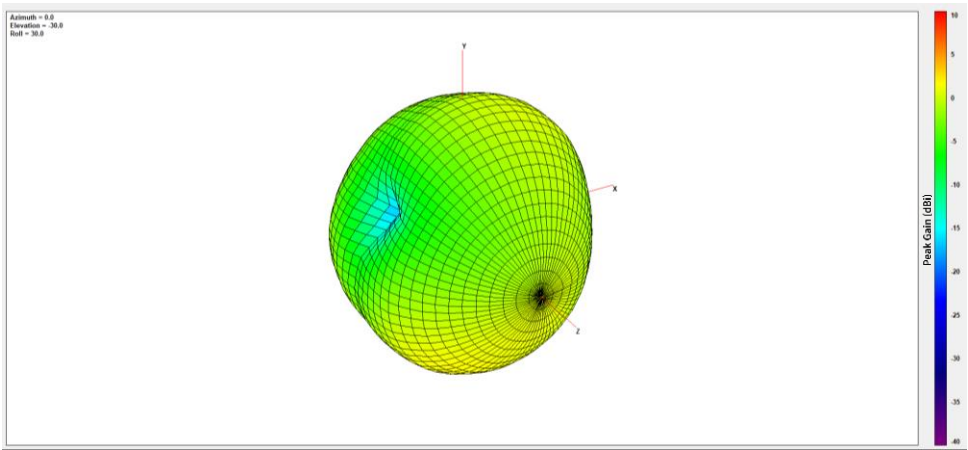

1425 MHz

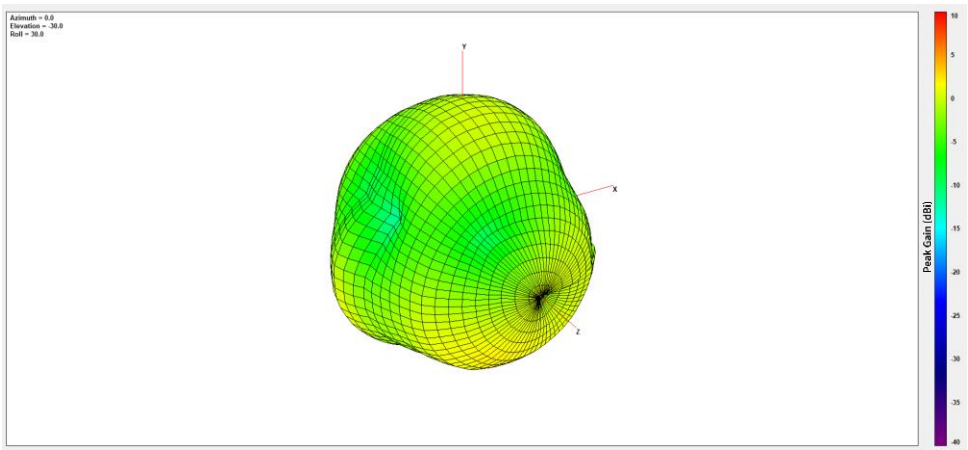

1520 MHz

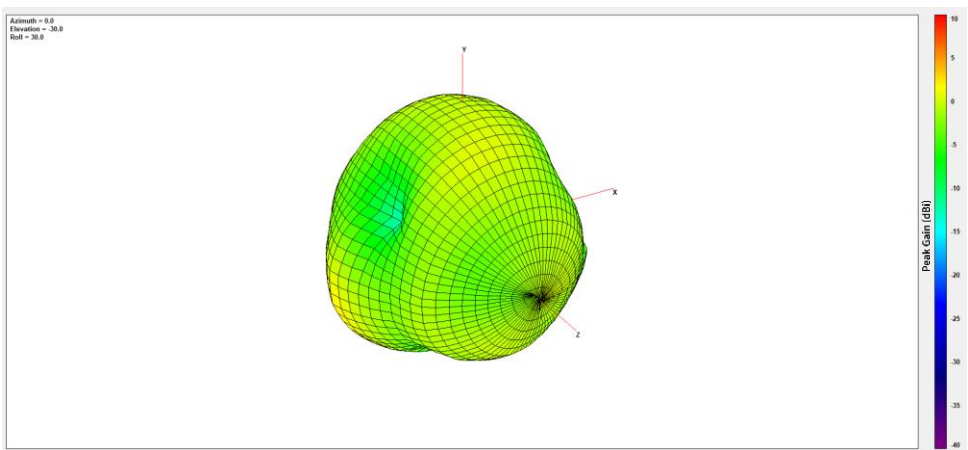

1710 MHz

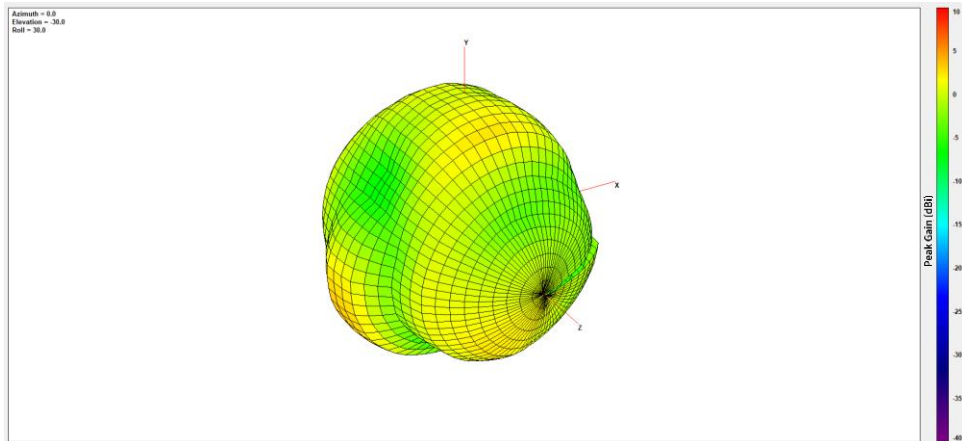

1850 MHz

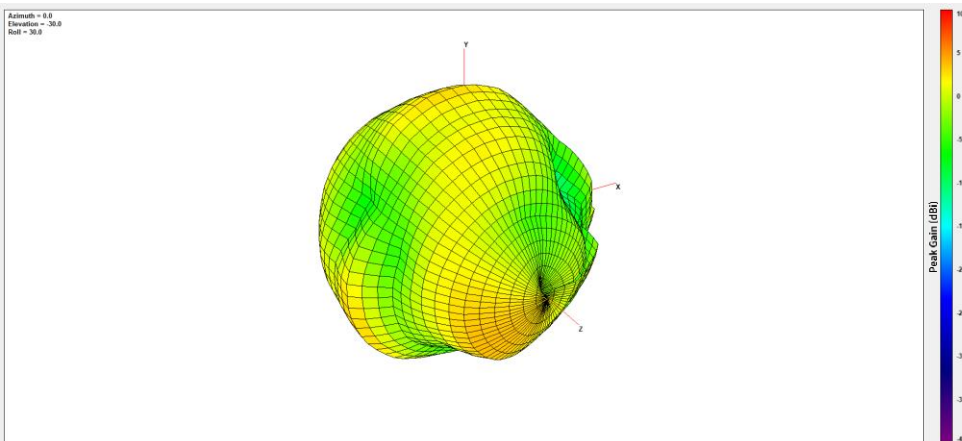

1910 MHz

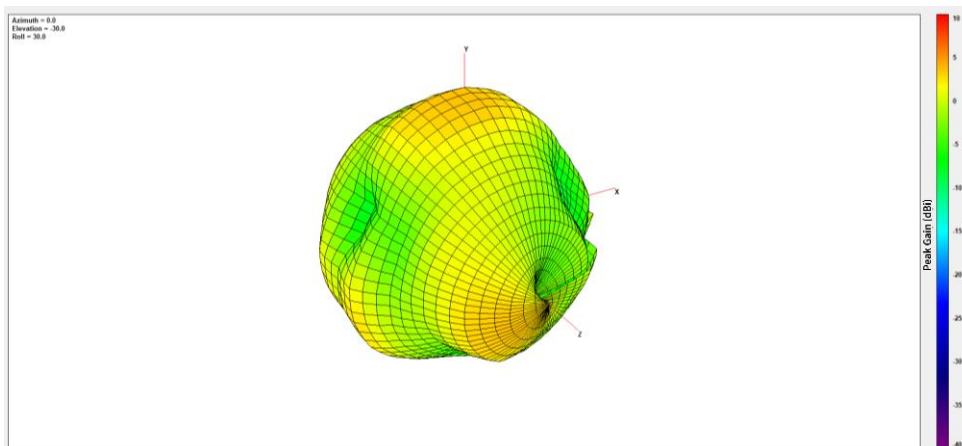



2450 MHz

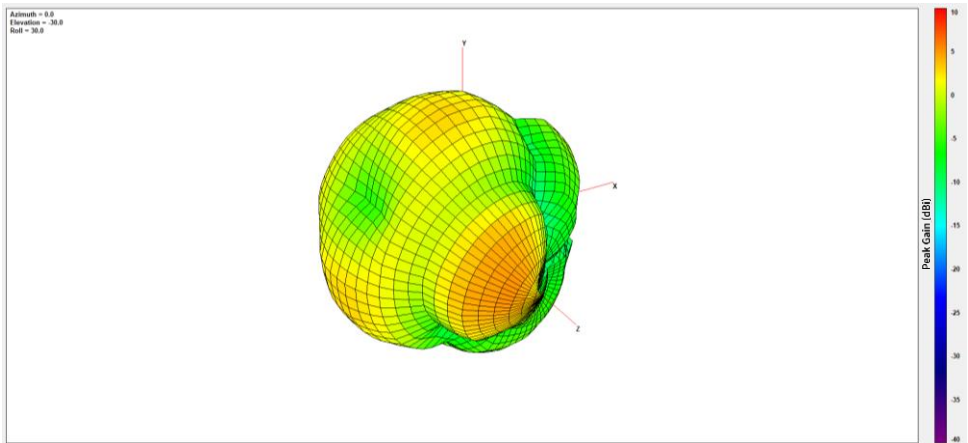

2550 MHz

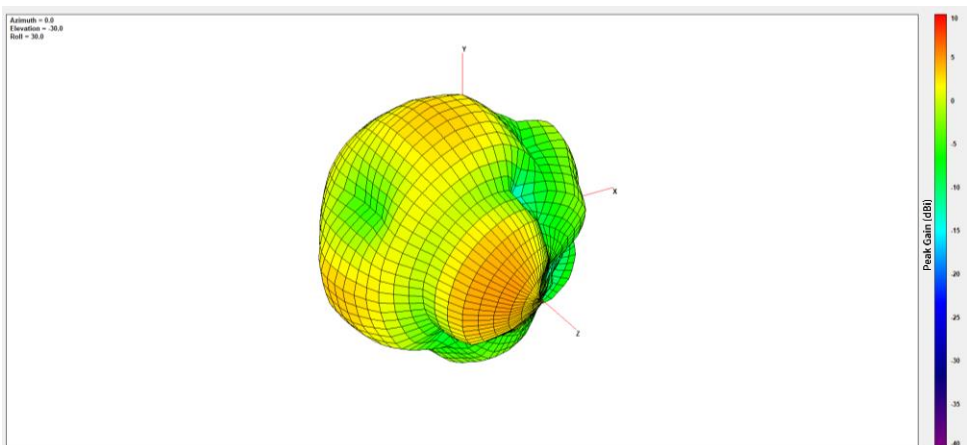

2700 MHz

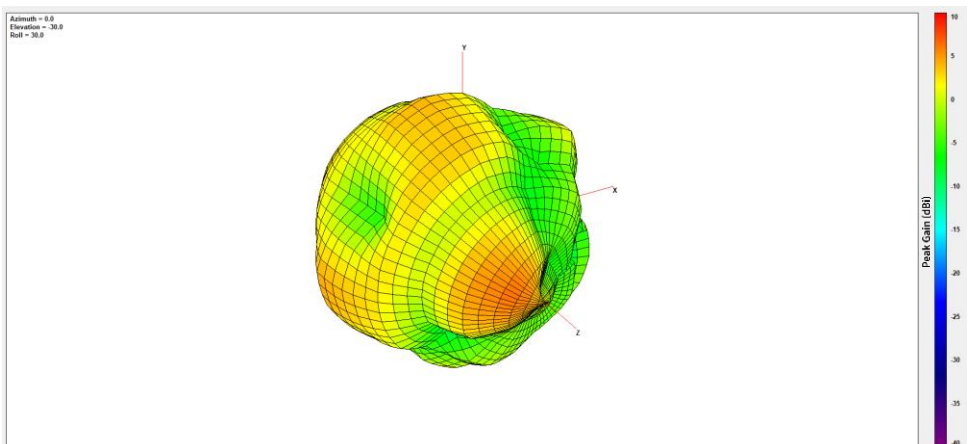



3300 MHz

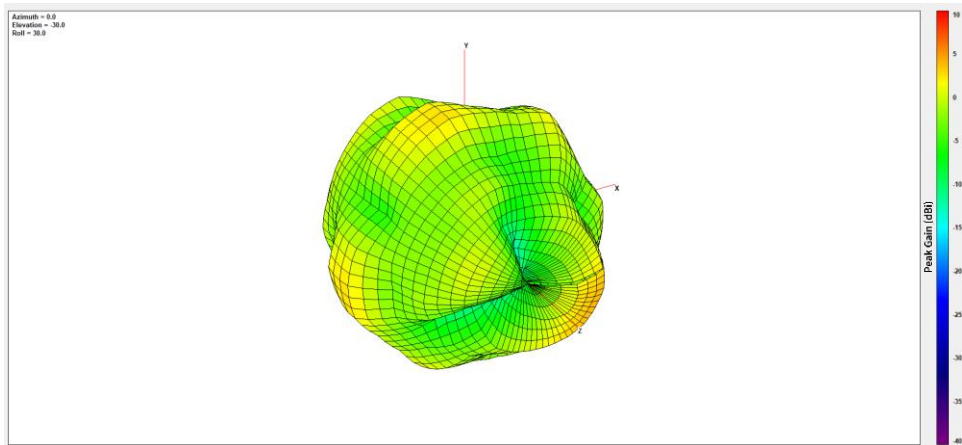

4300 MHz

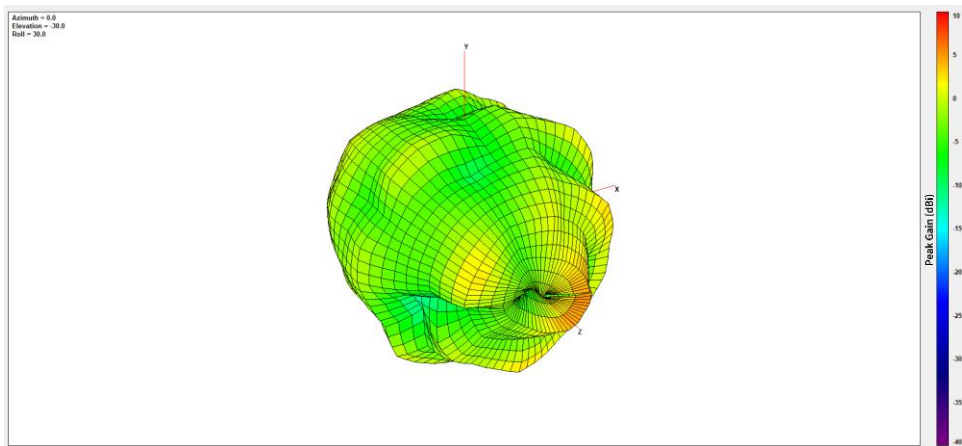

6000 MHz

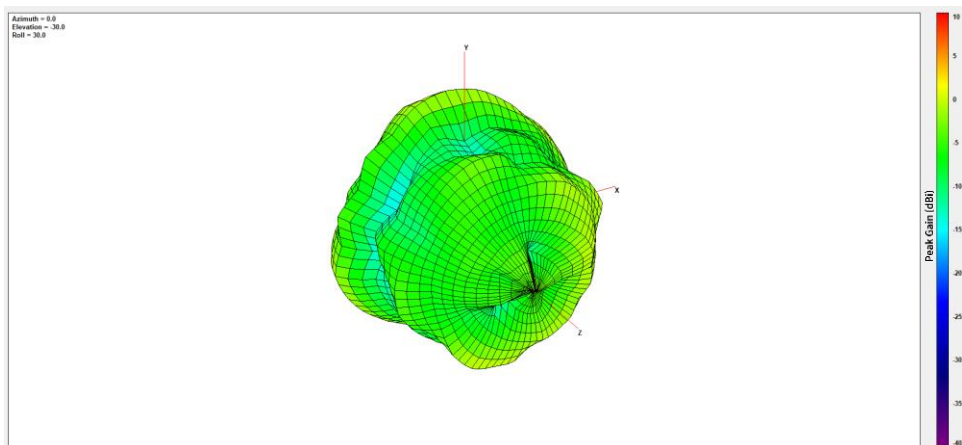

# 6. Mechanical Drawing (Units: mm)

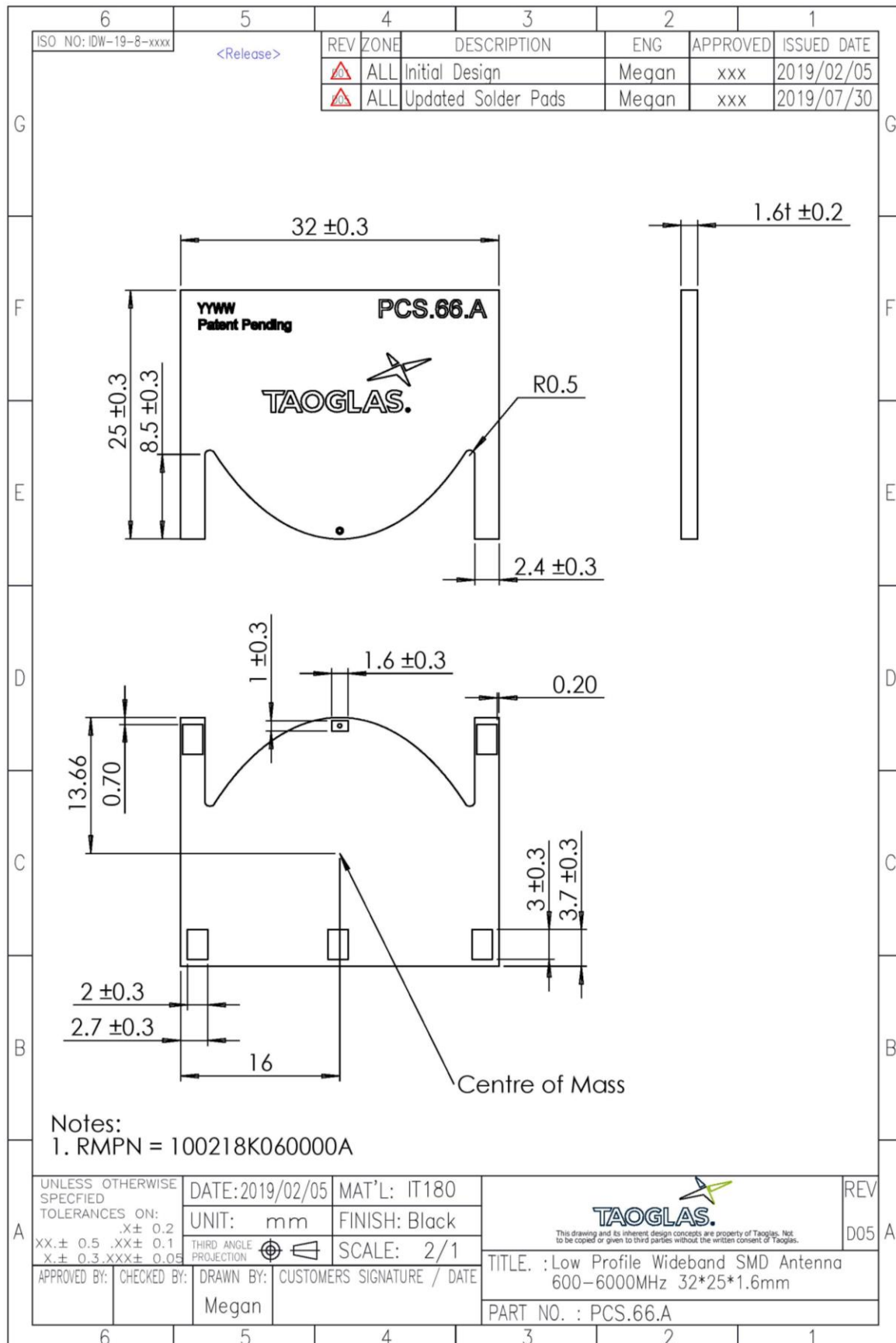

## 7. Layout Dimensions

Pads 2 and 3 are the same size. Pads 4 and 6 are the same size. Pad 1 should be connected to a 50 ohm transmission line.

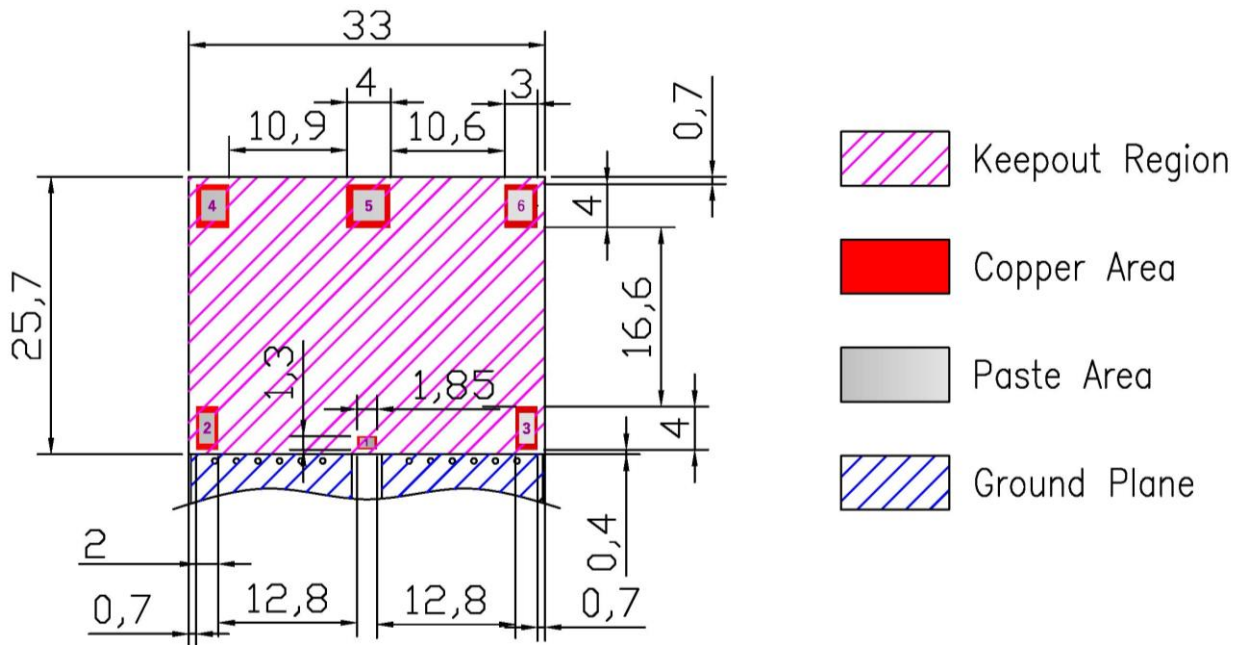

Note:

1. Ground Keepout should extend through any inner PCB layers and any sides around the antenna until the board edge to minimize coupling from feed to ground, except the side facing system ground
2. Any vias in pads should be either filled or tented to prevent solder from wicking away from the pad during reflow
3. The dimension tolerances should follow standard PCB manufacturing guidelines
4. Solder paste area is 75% of copper area dimensions
5. Centre of mass is 1.17mm offset in Y from geometric centre

# 8. EVB Drawing

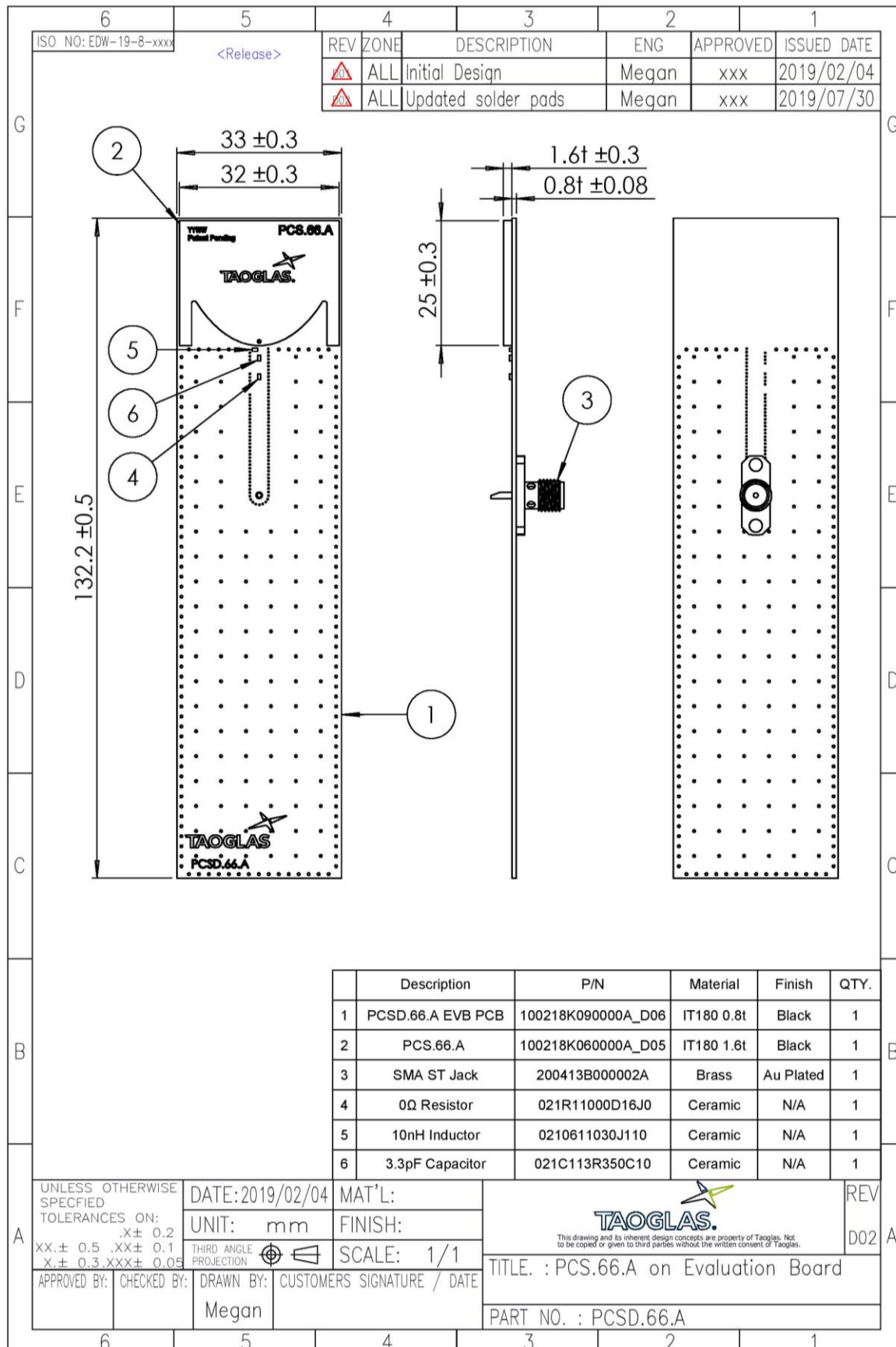

## 9. Matching Circuit

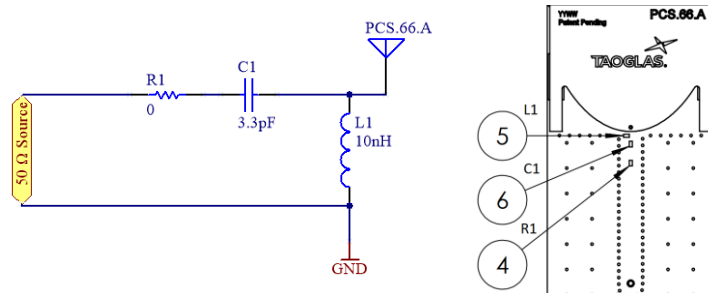

Circuit Symbol	Size	Description
L1	0402	10nH inductor (L-07C10NJV6T)
C1	0402	3.3pF Capacitor (GJM1555C1H3R3BB01D)

## 10. Packaging

500pcs PCS.66.A per Tape & Reel  
 Dimensions -  $\varnothing 330 \times 56$ mm  
 Weight – 2.2Kg

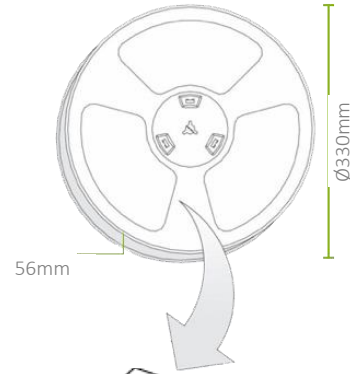

500pcs PCS.66.A per Box  
 Dimensions - 350\*340\*85mm  
 Weight – 2.3Kg

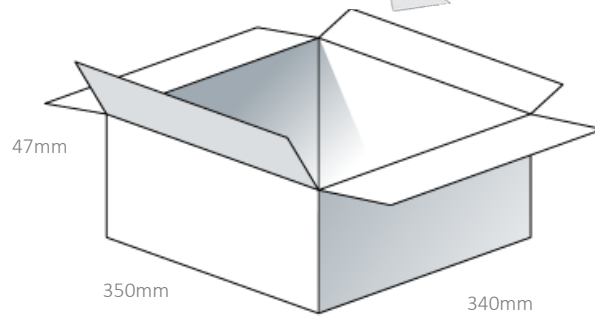

1500pcs PCS.66.A per Carton  
 Dimensions - 360\*370\*275mm  
 Weight – 7Kg

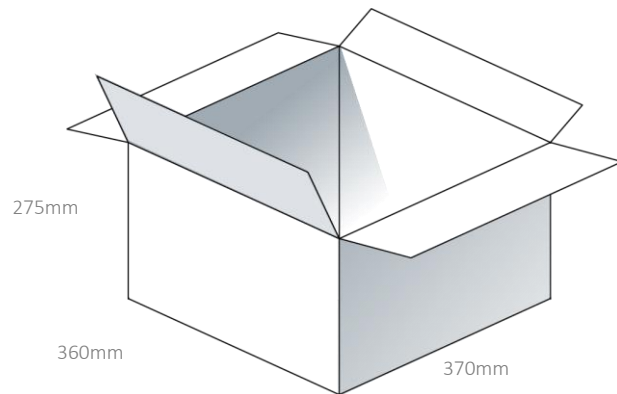

**Pallet Dimensions:**  
 1100\*720\*1270mm  
 24 Cartons Per Pallet  
 6 Cartons Per Layer  
 4 Layers

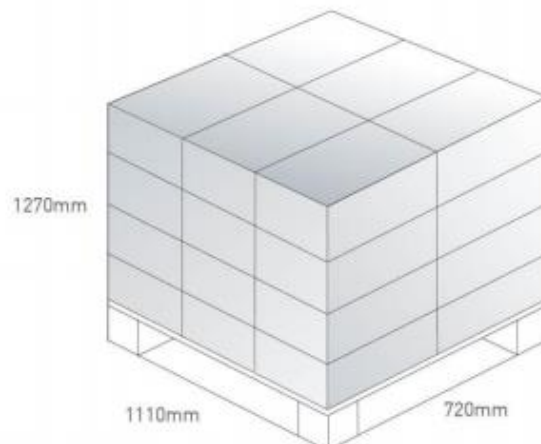

Changelog for the datasheet

**SPE-19-8-012 – PCS.66.A**

**Revision: E (Current Version)**

Date:	2020-01-02
Changes:	Updated
Changes Made by:	Jack Conroy

**Previous Revisions**

**Revision: D**

Date:	2019-08-16
Changes:	Updated Drawings and Pad Layout
Changes Made by:	Jack Conroy

**Revision: C**

Date:	2019-08-02
Changes:	Updated Drawings
Changes Made by:	Jack Conroy

**Revision: B**

Date:	2019-04-26
Changes:	Updated Layout Dimensions & Added Packaging
Changes Made by:	Jack Conroy

**Revision: A (Original Release)**

Date:	2019-02-22
Notes:	Initial Datasheet Release
Author:	Yu Kai Yeung



[www.taoglas.com](http://www.taoglas.com)





Компания «Океан Электроники» предлагает заключение долгосрочных отношений при поставках импортных электронных компонентов на взаимовыгодных условиях!

Наши преимущества:

- Поставка оригинальных импортных электронных компонентов напрямую с производств Америки, Европы и Азии, а так же с крупнейших складов мира;
- Широкая линейка поставок активных и пассивных импортных электронных компонентов (более 30 млн. наименований);
- Поставка сложных, дефицитных, либо снятых с производства позиций;
- Оперативные сроки поставки под заказ (от 5 рабочих дней);
- Экспресс доставка в любую точку России;
- Помощь Конструкторского Отдела и консультации квалифицированных инженеров;
- Техническая поддержка проекта, помощь в подборе аналогов, поставка прототипов;
- Поставка электронных компонентов под контролем ВП;
- Система менеджмента качества сертифицирована по Международному стандарту ISO 9001;
- При необходимости вся продукция военного и аэрокосмического назначения проходит испытания и сертификацию в лаборатории (по согласованию с заказчиком);
- Поставка специализированных компонентов военного и аэрокосмического уровня качества (Xilinx, Altera, Analog Devices, Intersil, Interpoint, Microsemi, Actel, Aeroflex, Peregrine, VPT, Syfer, Eurofarad, Texas Instruments, MS Kennedy, Miteq, Cobham, E2V, MA-COM, Hittite, Mini-Circuits, General Dynamics и др.);

Компания «Океан Электроники» является официальным дистрибьютором и эксклюзивным представителем в России одного из крупнейших производителей разъемов военного и аэрокосмического назначения «JONHON», а так же официальным дистрибьютором и эксклюзивным представителем в России производителя высокотехнологичных и надежных решений для передачи СВЧ сигналов «FORSTAR».



## JONHON

«JONHON» (основан в 1970 г.)

Разъемы специального, военного и аэрокосмического назначения:

(Применяются в военной, авиационной, аэрокосмической, морской, железнодорожной, горно- и нефтедобывающей отраслях промышленности)

«FORSTAR» (основан в 1998 г.)

ВЧ соединители, коаксиальные кабели, кабельные сборки и микроволновые компоненты:

(Применяются в телекоммуникациях гражданского и специального назначения, в средствах связи, РЛС, а так же военной, авиационной и аэрокосмической отраслях промышленности).



Телефон: 8 (812) 309-75-97 (многоканальный)

Факс: 8 (812) 320-03-32

Электронная почта: [ocean@oceanchips.ru](mailto:ocean@oceanchips.ru)

Web: <http://oceanchips.ru/>

Адрес: 198099, г. Санкт-Петербург, ул. Калинина, д. 2, корп. 4, лит. А