

1.5V Drive Pch +SBD MOSFET

TT8U2

●Structure

Silicon P-channel MOSFET / schottky barrier diode

●Features

- 1) Pch MOSFET and shottky barrier diode are put in TSST8 package.
- 2) High-speed switching and Low on-resistance.
- 3) Low voltage drive(1.5V).
- 4) Built in Low I_R shottky barrier diode.

●Applications

Switching

●Packaging specifications

Type	Package	Taping
	Code	TR
	Basic ordering unit (pieces)	3000
TT8U2		○

●Absolute maximum ratings (Ta = 25°C)

<MOSFET>

Parameter	Symbol	Limits	Unit	
Drain-source voltage	V_{DSS}	-20	V	
Gate-source voltage	V_{GSS}	±10	V	
Drain current	Continuous	I_D	±2.4	A
	Pulsed	I_{DP}	±9.6	A
Source current (Body Diode)	Continuous	I_S	-0.8	A
	Pulsed	I_{SP}^{*1}	-9.6	A
Channel temperature	Tch	150	°C	
Power dissipation	P_D^{*2}	1.0	W / ELEMENT	

*1 $P_w \leq 10\mu s$, Duty cycle $\leq 1\%$

*2 Mounted on a ceramic board.

<Di>

Parameter	Symbol	Limits	Unit
Repetitive peak reverse voltage	V_{RM}	30	V
Reverse voltage	V_R	20	V
Forward current	I_F	1.0	A
Forward current surge peak	I_{FSM}^{*1}	3.0	A
Junction temperature	T_j	150	°C
Power dissipation	P_D^{*2}	1.0	W / ELEMENT

*1 60Hz / 1Cycle

*2 Mounted on a ceramic board

<MOSFET and Di>

Parameter	Symbol	Limits	Unit
Total power dissipation	P_D^*	1.25	W / TOTAL
Range of Storage temperature	Tstg	-55 to +150	°C

* Mounted on a ceramic board

●Dimensions (Unit : mm)

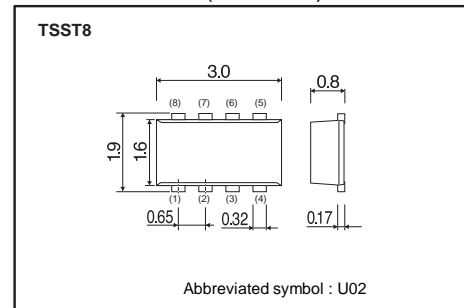

●Inner circuit

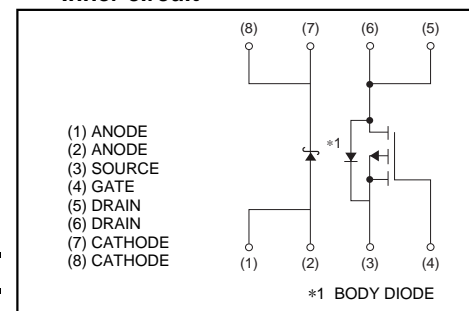

●Electrical characteristics (Ta=25°C)

<MOSFET>

Parameter	Symbol	Min.	Typ.	Max.	Unit	Conditions
Gate-source leakage	I_{GSS}	-	-	±100	nA	$V_{GS}=\pm 10V, V_{DS}=0V$
Drain-source breakdown voltage	$V_{(BR)DSS}$	-20	-	-	V	$I_D=-1mA, V_{GS}=0V$
Zero gate voltage drain current	I_{DSS}	-	-	-1	μA	$V_{DS}=-20V, V_{GS}=0V$
Gate threshold voltage	$V_{GS(th)}$	-0.3	-	-1.0	V	$V_{DS}=-10V, I_D=-1mA$
Static drain-source on-state resistance	$R_{DS(on)}$ *	-	80	105	mΩ	$I_D=-2.4A, V_{GS}=-4.5V$
		-	105	140	mΩ	$I_D=-1.2A, V_{GS}=-2.5V$
		-	150	225	mΩ	$I_D=-1.2A, V_{GS}=-1.8V$
		-	180	360	mΩ	$I_D=-0.5A, V_{GS}=-1.5V$
Forward transfer admittance	$ Y_{fs} ^*$	2.4	-	-	S	$V_{DS}=-10A, I_D=-2.4V$
Input capacitance	C_{iss}	-	850	-	pF	$V_{DS}=-10V$
Output capacitance	C_{oss}	-	60	-	pF	$V_{GS}=0V$
Reverse transfer capacitance	C_{rss}	-	50	-	pF	$f=1MHz$
Turn-on delay time	$t_{d(on)}$ *	-	9	-	ns	$V_{DD} \approx -10V, V_{GS}=-4.5V$
Rise time	t_r *	-	25	-	ns	$I_D=-1.2A,$
Turn-off delay time	$t_{d(off)}$ *	-	55	-	ns	$R_L \approx 8.3\Omega$
Fall time	t_f *	-	45	-	ns	$R_G=10\Omega$
Total gate charge	Q_g *	-	6.7	-	nC	$V_{DD} \approx -10V, V_{GS}=-4.5V$
Gate-source charge	Q_{gs} *	-	1.7	-	nC	$I_D=-2.4A,$
Gate-drain charge	Q_{gd} *	-	0.6	-	nC	$R_L \approx 4.2\Omega, R_G=10\Omega$

*Pulsed

●Body diode(source-drain) (Ta=25°C)

<MOSFET>

Parameter	Symbol	Min.	Typ.	Max.	Unit	Conditions
Forward Voltage	V_{SD}	-	-	-1.2	V	$I_S=-2.4A, V_{GS}=0V$

*Pulsed

<Di>

Parameter	Symbol	Min.	Typ.	Max.	Unit	Conditions
Forward Voltage drop	V_F	-	0.48	0.52	V	$I_F=1.0A$
Reverse leakage	I_R	-	-	10	μA	$V_R=10V$

●Electrical characteristic curves (Ta=25°C)

<MOSFET>

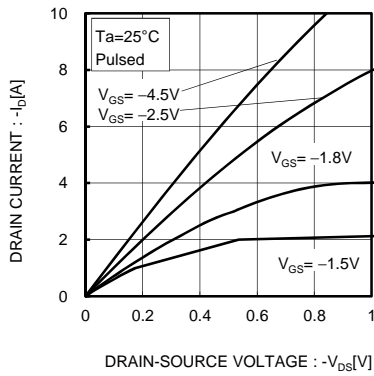

Fig.1 Typical output characteristics (I)

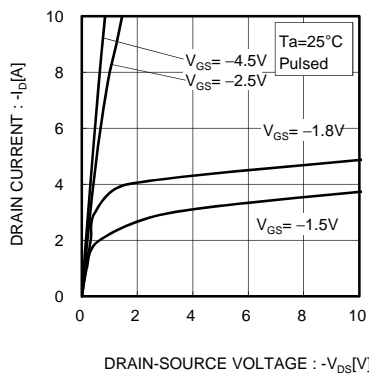

Fig.2 Typical output characteristics(II)

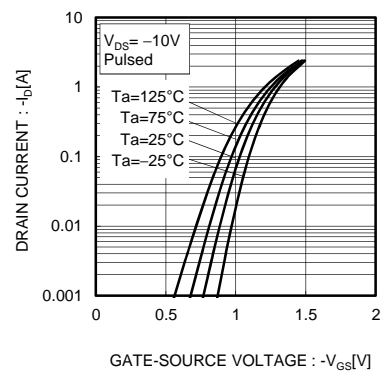

Fig.3 Typical Transfer Characteristics

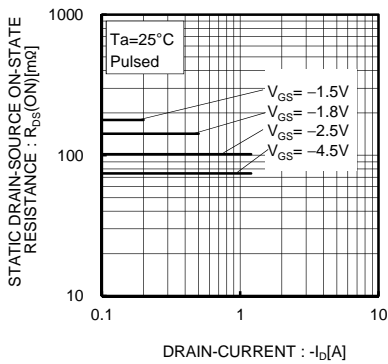

Fig.4 Static Drain-Source On-State Resistance vs. Drain Current (I)

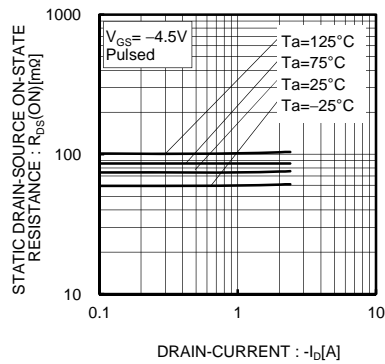

Fig.5 Static Drain-Source On-State Resistance vs. Drain Current(II)

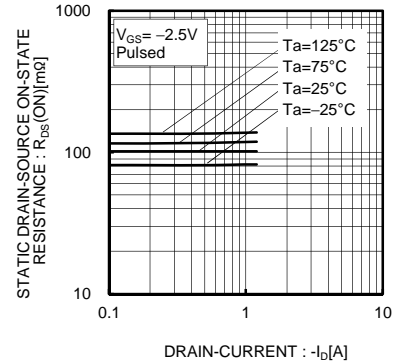

Fig.6 Static Drain-Source On-State Resistance vs. Drain Current(III)

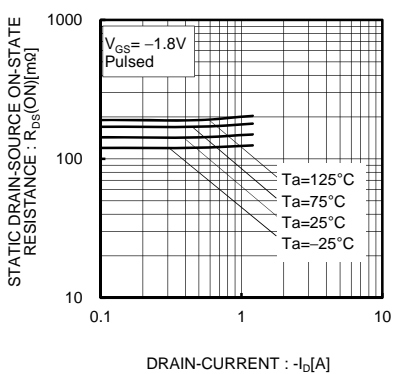

Fig.7 Static Drain-Source On-State Resistance vs. Drain Current(IV)

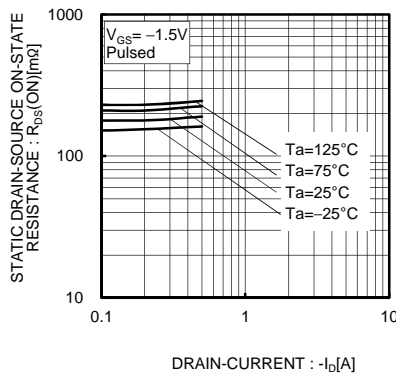

Fig.8 Static Drain-Source On-State Resistance vs. Drain Current(V)

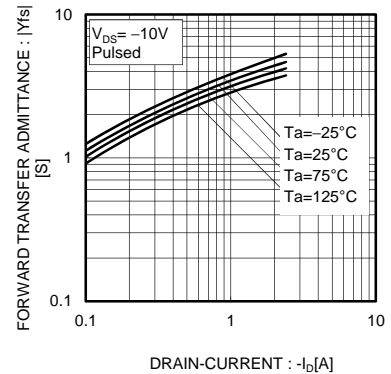

Fig.9 Forward Transfer Admittance vs. Drain Current

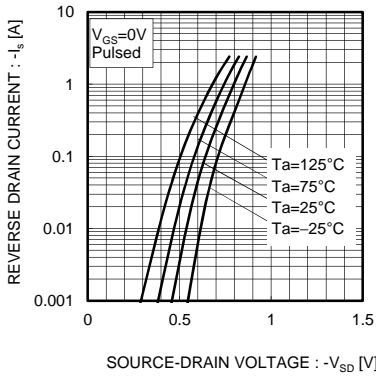

Fig.10 Reverse Drain Current vs. Source-Drain Voltage

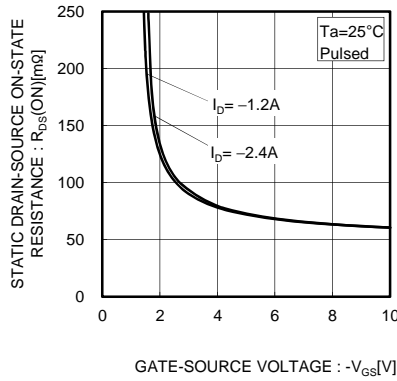

Fig.11 Static Drain-Source On-State Resistance vs. Gate Source Voltage

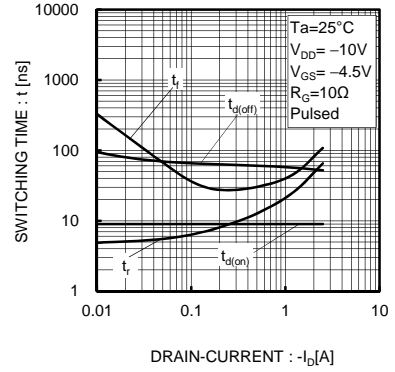

Fig.12 Switching Characteristics

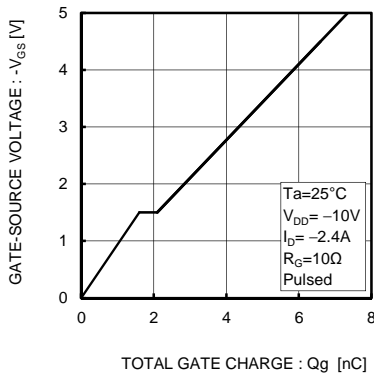

Fig.13 Dynamic Input Characteristics

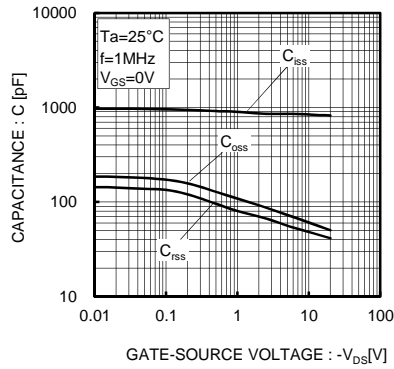

Fig.14 Typical Capacitance vs. Drain-Source Voltage

<Di>

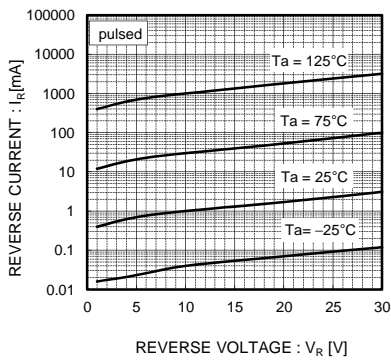

Fig.1 Reverse Current vs. Reverse Voltage

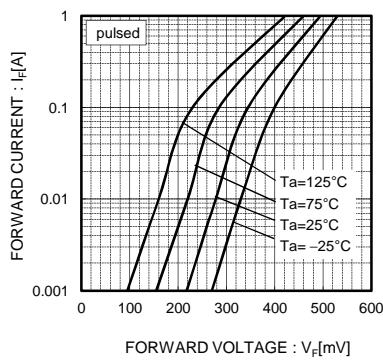

Fig.2 Forward Current vs. Forward Voltage

●Measurement circuits

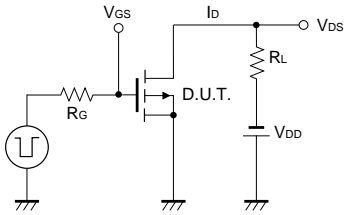

Fig.1-1 Switching Time Measurement Circuit

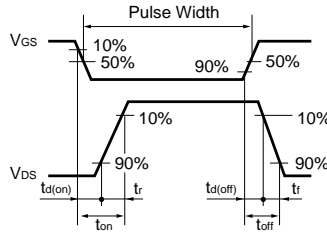

Fig.1-2 Switching Waveforms

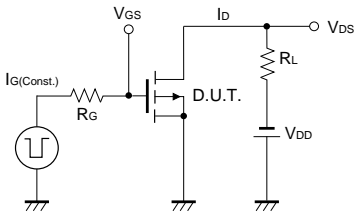

Fig.2-1 Gate Charge Measurement Circuit

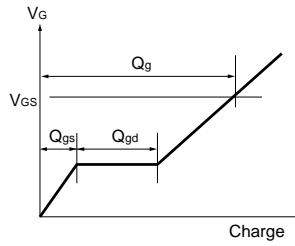

Fig.2-2 Gate Charge Waveform

●Notice

1. SBD has a large reverse leak current compared to other type of diode. Therefore ; it would raise a junction temperature, and increase a reverse power loss. Further rise of inside temperature would cause a thermal runaway. This built-in SBD has low V_F characteristics and therefore, higher leak current. Please consider enough the surrounding temperature, generating heat of MOSFET and the reverse current.

2. This product might cause chip aging and breakdown under the large electrified environment. Please consider to design ESD protection circuit.

Notes

No copying or reproduction of this document, in part or in whole, is permitted without the consent of ROHM Co.,Ltd.

The content specified herein is subject to change for improvement without notice.

The content specified herein is for the purpose of introducing ROHM's products (hereinafter "Products"). If you wish to use any such Product, please be sure to refer to the specifications, which can be obtained from ROHM upon request.

Examples of application circuits, circuit constants and any other information contained herein illustrate the standard usage and operations of the Products. The peripheral conditions must be taken into account when designing circuits for mass production.

Great care was taken in ensuring the accuracy of the information specified in this document. However, should you incur any damage arising from any inaccuracy or misprint of such information, ROHM shall bear no responsibility for such damage.

The technical information specified herein is intended only to show the typical functions of and examples of application circuits for the Products. ROHM does not grant you, explicitly or implicitly, any license to use or exercise intellectual property or other rights held by ROHM and other parties. ROHM shall bear no responsibility whatsoever for any dispute arising from the use of such technical information.

The Products specified in this document are intended to be used with general-use electronic equipment or devices (such as audio visual equipment, office-automation equipment, communication devices, electronic appliances and amusement devices).

The Products specified in this document are not designed to be radiation tolerant.

While ROHM always makes efforts to enhance the quality and reliability of its Products, a Product may fail or malfunction for a variety of reasons.

Please be sure to implement in your equipment using the Products safety measures to guard against the possibility of physical injury, fire or any other damage caused in the event of the failure of any Product, such as derating, redundancy, fire control and fail-safe designs. ROHM shall bear no responsibility whatsoever for your use of any Product outside of the prescribed scope or not in accordance with the instruction manual.

The Products are not designed or manufactured to be used with any equipment, device or system which requires an extremely high level of reliability the failure or malfunction of which may result in a direct threat to human life or create a risk of human injury (such as a medical instrument, transportation equipment, aerospace machinery, nuclear-reactor controller, fuel-controller or other safety device). ROHM shall bear no responsibility in any way for use of any of the Products for the above special purposes. If a Product is intended to be used for any such special purpose, please contact a ROHM sales representative before purchasing.

If you intend to export or ship overseas any Product or technology specified herein that may be controlled under the Foreign Exchange and the Foreign Trade Law, you will be required to obtain a license or permit under the Law.



Thank you for your accessing to ROHM product informations.
More detail product informations and catalogs are available, please contact us.

ROHM Customer Support System

<http://www.rohm.com/contact/>

Компания «Океан Электроники» предлагает заключение долгосрочных отношений при поставках импортных электронных компонентов на взаимовыгодных условиях!

Наши преимущества:

- Поставка оригинальных импортных электронных компонентов напрямую с производств Америки, Европы и Азии, а так же с крупнейших складов мира;
- Широкая линейка поставок активных и пассивных импортных электронных компонентов (более 30 млн. наименований);
- Поставка сложных, дефицитных, либо снятых с производства позиций;
- Оперативные сроки поставки под заказ (от 5 рабочих дней);
- Экспресс доставка в любую точку России;
- Помощь Конструкторского Отдела и консультации квалифицированных инженеров;
- Техническая поддержка проекта, помощь в подборе аналогов, поставка прототипов;
- Поставка электронных компонентов под контролем ВП;
- Система менеджмента качества сертифицирована по Международному стандарту ISO 9001;
- При необходимости вся продукция военного и аэрокосмического назначения проходит испытания и сертификацию в лаборатории (по согласованию с заказчиком);
- Поставка специализированных компонентов военного и аэрокосмического уровня качества (Xilinx, Altera, Analog Devices, Intersil, Interpoint, Microsemi, Actel, Aeroflex, Peregrine, VPT, Syfer, Eurofarad, Texas Instruments, MS Kennedy, Miteq, Cobham, E2V, MA-COM, Hittite, Mini-Circuits, General Dynamics и др.);

Компания «Океан Электроники» является официальным дистрибьютором и эксклюзивным представителем в России одного из крупнейших производителей разъемов военного и аэрокосмического назначения «**JONHON**», а так же официальным дистрибьютором и эксклюзивным представителем в России производителя высокотехнологичных и надежных решений для передачи СВЧ сигналов «**FORSTAR**».



JONHON

«**JONHON**» (основан в 1970 г.)

Разъемы специального, военного и аэрокосмического назначения:

(Применяются в военной, авиационной, аэрокосмической, морской, железнодорожной, горно- и нефтедобывающей отраслях промышленности)

«**FORSTAR**» (основан в 1998 г.)

ВЧ соединители, коаксиальные кабели,
кабельные сборки и микроволновые компоненты:

(Применяются в телекоммуникациях гражданского и специального назначения, в средствах связи, РЛС, а так же военной, авиационной и аэрокосмической отраслях промышленности).



Телефон: 8 (812) 309-75-97 (многоканальный)

Факс: 8 (812) 320-03-32

Электронная почта: ocean@oceanchips.ru

Web: <http://oceanchips.ru/>

Адрес: 198099, г. Санкт-Петербург, ул. Калинина, д. 2, корп. 4, лит. А