

Infrared Transceiver, 9.6 kbit/s to 115.2 kbit/s (SIR)



20206



DESCRIPTION

The TFBS4650 is one of the smallest IrDA[®] compliant transceivers available. It supports data rates up to 115 kbit/s. The transceiver consists of a PIN photodiode, infrared emitter, and control IC in a single package.

FEATURES

- Compliant with the IrDA physical layer IrPHY 1.4 (low power specification, 9.6 kbit/s to 115.2 kbit/s)
- Link distance: 30 cm/20 cm full 15° cone with standard or low power IrDA, respectively. Emission intensity can be set by an external resistor to increase the range for extended low power spec to > 50 cm
- Typical transmission distance to standard device: 50 cm
- Small package (L x W x H in mm): 6.8 x 2.8 x 1.6
- Low current consumption 75 μ A idle at 3.6 V
- Shutdown current 10 nA typical at 25 °C
- Operates from 2.4 V to 3.6 V within specification over full temperature range from - 25 °C to + 85 °C
- Split power supply, emitter can be driven by a separate power supply not loading the regulated. U.S. pat. no. 6,157,476
- Qualified for lead (Pb)-free and Sn/Pb processing (MSL4)
- Compliant to RoHS directive 2002/95/EC and in accordance to WEEE 2002/96/EC

RoHS
COMPLIANT

APPLICATIONS

- Mobile phone
- PDAs

PRODUCT SUMMARY

PART NUMBER	DATA RATE (kbit/s)	DIMENSIONS H x L x W (mm x mm x mm)	LINK DISTANCE (m)	OPERATING VOLTAGE (V)	IDLE SUPPLY CURRENT (mA)
TFBS4650	115.2	1.6 x 6.8 x 2.8	0 to \geq 0.3	2.4 to 3.6	0.075

PARTS TABLE

PART	DESCRIPTION	QTY/REEL
TFBS4650-TR1	Oriented in carrier tape for side view surface mounting	1000 pcs
TFBS4650-TR3	Oriented in carrier tape for side view surface mounting	2500 pcs
TFBS4650-TR4	Oriented in carrier tape for side view surface mounting	6000 pcs
TFBS4650-TT3	Oriented in carrier tape for top view surface mounting	2500 pcs

FUNCTIONAL BLOCK DIAGRAM

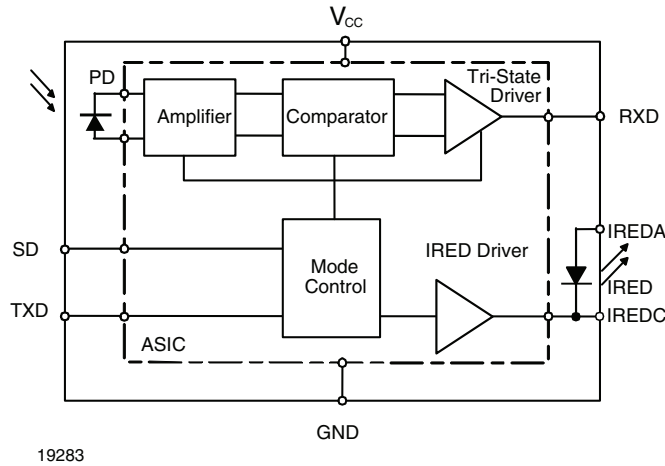

19283

PIN DESCRIPTION				
PIN NUMBER	SYMBOL	DESCRIPTION	I/O	ACTIVE
1	IREDA	IRED anode, connected via a current limiting resistor to V_{CC2} . A separate unregulated power supply can be used.		
2	IREDC	IRED cathode, do not connect for standard operation.		
3	TXD	Transmitter data input. Setting this input above the threshold turns on the transmitter. This input switches the IRED with the maximum transmit pulse width of about 100 μ s.	I	High
4	RXD	Receiver output. Normally high, goes low for a defined pulse duration with the rising edge of the optical input signal. Output is a CMOS tri-state driver, which swings between ground and V_{CC} . Receiver echoes transmitter output.	O	Low
5	SD	Shutdown. Logic low at this input enables the receiver, enables the transmitter, and un-tri-states the receiver output. It must be driven high for shutting down the transceiver.	I	High
6	V_{CC}	Power supply, 2.4 V to 3.6 V. This pin provides power for the receiver and transmitter drive section. Connect V_{CC1} via an optional filter.		
7	GND	Ground		

PINOUT

TFBS4650, bottom view
weight 0.05 g

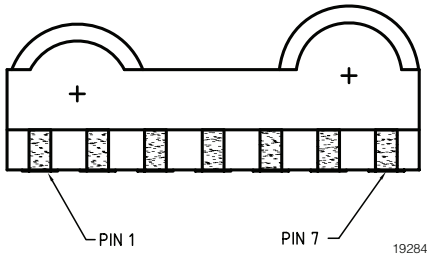

19284

Definitions:

In the Vishay transceiver datasheets the following nomenclature is used for defining the IrDA operating modes:
 SIR: 2.4 kbit/s to 115.2 kbit/s, equivalent to the basic serial infrared standard with the physical layer version IrPhy 1.0
 MIR: 576 kbit/s to 1152 kbit/s
 FIR: 4 Mbit/s
 VFIR: 16 Mbit/s
 MIR and FIR were implemented with IrPhy 1.1, followed by IrPhy 1.2, adding the SIR low power standard. IrPhy 1.3 extended the low power option to MIR and FIR and VFIR was added with IrPhy 1.4. A new version of the standard in any case obsoletes the former version.



ABSOLUTE MAXIMUM RATINGS						
PARAMETER	TEST CONDITIONS	SYMBOL	MIN.	TYP.	MAX.	UNIT
Supply voltage range, transceiver	$0\text{ V} < V_{CC2} < 6\text{ V}$	V_{CC1}	- 0.5		6	V
Supply voltage range, transmitter	$0\text{ V} < V_{CC1} < 3.6\text{ V}$	V_{CC2}	- 0.5		6	V
Voltage at RXD	All states	V_{IN}	- 0.5		$V_{CC} + 0.5$	V
Input voltage range, transmitter TXD	Independent of V_{CC1} or V_{CC2}	V_{IN}	- 0.5		6	V
Input currents	For all pins, except IRED anode pin		- 40		40	mA
Output sinking current					20	mA
Power dissipation		P_D			250	mW
Junction temperature		T_J			125	°C
Ambient temperature range (operating)		T_{amb}	- 25		+ 85	°C
Storage temperature range		T_{stg}	- 40		+ 100	°C
Soldering temperature ⁽¹⁾	See section "Recommended Solder Profile"					°C
Repetitive pulse output current	$< 90\text{ }\mu\text{s}$, $t_{on} < 20\%$	I_{IRED} (RP)			500	mA
Average output current (transmitter)		I_{IRED} (DC)			100	mA

Note

Reference point pin, ground unless otherwise noted.

Typical values are for DESIGN AID ONLY, not guaranteed nor subject to production testing.

⁽¹⁾ Sn/lead (Pb)-free soldering. The product passed Vishay's standard convection reflow profile soldering test.

EYE SAFETY INFORMATION	
STANDARD	CLASSIFICATION
IEC/EN 60825-1 (2007-03), DIN EN 60825-1 (2008-05) "SAFETY OF LASER PRODUCTS - Part 1: equipment classification and requirements", simplified method	Class 1
IEC 62471 (2006), CIE S009 (2002) "Photobiological Safety of Lamps and Lamp Systems"	Exempt
DIRECTIVE 2006/25/EC OF THE EUROPEAN PARLIAMENT AND OF THE COUNCIL of 5 th April 2006 on the minimum health and safety requirements regarding the exposure of workers to risks arising from physical agents (artificial optical radiation) (19 th individual directive within the meaning of article 16(1) of directive 89/391/EEC)	Exempt

Note

Vishay transceivers operating inside the absolute maximum ratings are classified as eye safe according the above table.

ELECTRICAL CHARACTERISTICS						
PARAMETER	TEST CONDITIONS	SYMBOL	MIN.	TYP.	MAX.	UNIT
TRANSCEIVER						
Supply voltage range		V_{CC}	2.4		3.6	V
Dynamic supply current						
Idle, dark ambient	SD = low (< 0.8 V), $E_{eamb} = 0$ klx, $E_e < 4$ mW/m ² - 25 °C ≤ T ≤ + 85 °C	I_{CC}		90	130	μA
Idle, dark ambient	SD = low (< 0.8 V), $E_{eamb} = 0$ klx, $E_e < 4$ mW/m ² T = + 25 °C	I_{CC}		75		μA
Peak supply current during transmission	SD = low, TXD = high	I_{CCPK}		2	3	mA
Shutdown supply current dark ambient	SD = high (> $V_{CC} - 0.5$ V), T = 25 °C, $E_e = 0$ klx	I_{SD}			0.1	μA
Shutdown supply current, dark ambient	SD = high (> $V_{CC} - 0.5$ V), - 25 °C ≤ T ≤ + 85 °C	I_{SD}			1	μA
Operating temperature range		T_A	- 25		+ 85	°C
Input voltage low (TXD, SD)		V_{IL}	- 0.5		0.5	V
Input voltage high	$V_{CC} = 2.4$ V to 3.6 V	V_{IH}	$V_{CC} - 0.5$		6	V
Input voltage threshold SD	$V_{CC} = 2.4$ V to 3.6 V		0.9	1.35	1.8	V
Output voltage low	$V_{CC} = 2.4$ V to 3.6 V $C_{LOAD} = 15$ pF	V_{OL}	- 0.5		$V_{CC} \times 0.15$	V
Output voltage high	$V_{CC} = 2.4$ V to 3.6 V $C_{LOAD} = 15$ pF	V_{OH}	$V_{CC} \times 0.8$		$V_{CC} + 0.5$	V
RXD to V_{CC} pull-up impedance	SD = V_{CC} $V_{CC} = 2.4$ V to 5 V	R_{RXD}		500		kΩ
Input capacitance (TXD, SD)		C_I			6	pF

Notes

$T_{amb} = 25$ °C, $V_{CC} = 2.4$ V to 3.6 V unless otherwise noted.

Typical values are for design aid only, not guaranteed nor subject to production testing.



OPTOELECTRONIC CHARACTERISTICS (1)						
PARAMETER	TEST CONDITIONS	SYMBOL	MIN.	TYP.	MAX.	UNIT
RECEIVER						
Sensitivity: minimum irradiance E_e in angular range (2)(3)	9.6 kbit/s to 115.2 kbit/s $\lambda = 850 \text{ nm to } 900 \text{ nm}$	E_e		40 (4)	81 (8.1)	mW/m^2 ($\mu\text{W/cm}^2$)
Maximum irradiance E_e in angular range	$\lambda = 850 \text{ nm to } 900 \text{ nm}$	E_e	5 (500)			kW/m^2 (mW/cm^2)
No receiver output input irradiance (4)	According to IrDA IrPHY 1.4, appendix A1, fluorescent light specification	E_e	4 (0.4)			mW/m^2 ($\mu\text{W/cm}^2$)
Rise time of output signal	10 % to 90 %, $C_L = 15 \text{ pF}$	$t_r(\text{RXD})$	20		100	ns
Fall time of output signal	90 % to 10 %, $C_L = 15 \text{ pF}$	$t_f(\text{RXD})$	20		100	ns
RXD pulse width of output signal, 50 % (5)	Input pulse width 1.63 μs	t_{PW}	1.7	2	2.9	μs
Receiver start up time	Power on delay			100	150	μs
Latency		t_L		50	200	μs
TRANSMITTER						
IRED operating current, current controlled	The IRED current is internally controlled but also can be reduced by an external resistor R1	I_D	200		400	mA
Output leakage IRED current	$T_{\text{amb}} = 85 \text{ }^\circ\text{C}$	I_{IRED}			1	μA
Output radiant intensity (6)	$\alpha = 0^\circ, 15^\circ$, TXD = high, SD = low, $V_{\text{CC1}} = 3 \text{ V}$, $V_{\text{CC2}} = 3 \text{ V}$, $R1 = 30 \text{ } \Omega$ (resulting in about 50 mA drive current)	I_e	4		150	mW/sr
Output radiant intensity (6)	$\alpha = 0^\circ, 15^\circ$, TXD = high, SD = low, $V_{\text{CC1}} = 3 \text{ V}$, $V_{\text{CC2}} = 3 \text{ V}$, $R1 = 0 \text{ } \Omega$, $I_F = 300 \text{ mA}$	I_e		25		mW/sr
Output radiant intensity (6)	$V_{\text{CC1}} = 5 \text{ V}$, $\alpha = 0^\circ, 15^\circ$ TXD = low or SD = high (receiver is inactive as long as SD = high)	I_e			0.04	mW/sr
Saturation voltage of IRED driver	$V_{\text{CC}} = 3 \text{ V}$, $I_F = 50 \text{ mA}$	V_{CEsat}		0.4		V
Peak - emission wavelength		λ_p	880	886	900	nm
Optical rise time, optical fall time		t_{ropt} t_{fopt}	20		100	ns
Optical output pulse duration	Input pulse width $t < 30 \text{ } \mu\text{s}$ Input pulse width $t \geq 30 \text{ } \mu\text{s}$	t_{opt} t_{opt}	30	t 50	300	μs μs
Optical output pulse duration	Input pulse width $t = 1.63 \text{ } \mu\text{s}$	t_{opt}	1.45	1.61	2.2	μs
Optical overshoot					20	%

Notes

- (1) $T_{\text{amb}} = 25 \text{ }^\circ\text{C}$, $V_{\text{CC}} = 2.4 \text{ V to } 3.6 \text{ V}$ unless otherwise noted. Typical values are for design aid only, not guaranteed nor subject to production testing.
- (2) This parameter reflects the backlight test of the IrDA physical layer specification to guarantee immunity against light from fluorescent lamps.
- (3) IrDA sensitivity definition: minimum irradiance E_e in angular range, power per unit area. The receiver must meet the BER specification while the source is operating at the minimum intensity in angular range into the minimum half-angular range at the maximum link length.
- (4) Maximum irradiance E_e in angular range, power per unit area. The optical delivered to the detector by a source operating at the maximum intensity in angular range at minimum link length must not cause receiver overdrive distortion and possible related link errors. If placed at the active output interface reference plane of the transmitter, the receiver must meet its bit error ratio (BER) specification. For more definitions see the document "Symbols and Terminology" on the Vishay website.
- (5) RXD output is edge triggered by the rising edge of the optical input signal. The output pulse duration is independent of the input pulse duration.
- (6) The radiant intensity can be adjusted by the external current limiting resistor to adapt the intensity to the desired value. The given value is for minimum current consumption. This transceiver can be adapted to > 50 cm operation by increasing the current to > 200 mA, e.g. operating the transceiver without current control resistor (i.e. $R1 = 0 \text{ } \Omega$) and using the internal current control.

TABLE 1 - TRUTH TABLE				
INPUTS			OUTPUTS	
SD	TXD	OPTICAL INPUT IRRADIANCE mW/m ²	RXD	TRANSMITTER
High	x	x	Tri-state floating with a weak pull-up to the supply voltage	0
Low	High	x	Low (echo on)	I _e
Low	High > 50 μs	x	High	0
Low	Low	< 4	High	0
Low	Low	> min. irradiance E _e < max. irradiance E _e	Low (active)	0
Low	Low	> max. irradiance E _e	x	0

RECOMMENDED CIRCUIT DIAGRAM

Operated at a clean low impedance power supply the TFBS4650 needs only one additional external component when the IRED drive current should be minimized for minimum current consumption according the low power IrDA standard. When combined operation in IrDA and remote control is intended no current limiting resistor is recommended.

However, depending on the entire system design and board layout, additional components may be required (see fig. 1). When long wires are used for bench tests, the capacitors are mandatory for testing rise/fall time correctly.

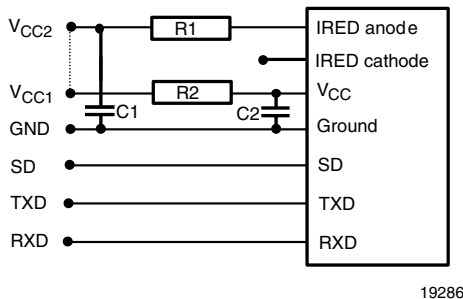

Fig. 1 - Recommended Application Circuit

The capacitor C1 is buffering the supply voltage V_{CC2} and eliminates the inductance of the power supply line. This one should be a small ceramic version or other fast capacitor to guarantee the fast rise time of the IRED current. The resistor R1 is necessary for controlling the IRED drive current when the internally controlled current is too high for the application. Vishay transceivers integrate a sensitive receiver and a built-in power driver. The combination of both needs a careful circuit board layout. The use of thin, long, resistive and inductive wiring should be avoided. The inputs (TXD, SD) and the output RXD should be directly (DC) coupled to the I/O circuit.

The capacitor C2 combined with the resistor R2 is the low pass filter for smoothing the supply voltage. As already stated above R2, C1 and C2 are optional and

depend on the quality of the supply voltages V_{CCx} and injected noise. An unstable power supply with dropping voltage during transmission may reduce the sensitivity (and transmission range) of the transceiver.

The placement of these parts is critical. It is strongly recommended to position C2 as close as possible to the transceiver power supply pins.

When connecting the described circuit to the power supply, low impedance wiring should be used.

In case of extended wiring the inductance of the power supply can cause dynamically a voltage drop at V_{CC2}. Often some power supplies are not able to follow the fast current is rise time. In that case another 10 μF cap at V_{CC2} will be helpful.

Keep in mind that basic RF-design rules for circuit design should be taken into account. Especially longer signal lines should not be used without termination. See e.g. "The Art of Electronics" Paul Horowitz, Wienfield Hill, 1989, Cambridge University Press, ISBN: 0521370957.

TABLE 2 - RECOMMENDED APPLICATION CIRCUIT COMPONENTS	
COMPONENT	RECOMMENDED VALUE
C1, C2	0.1 μF, Ceramic Vishay part# VJ 1206 Y 104 J XXMT
R1	See table 3
R2	47 Ω, 0.125 W (V _{CC1} = 3 V)

TABLE 3 - RECOMMENDED RESISTOR R1 (Ω)	
V _{CC2} (V)	MINIMIZED CURRENT CONSUMPTION, IrDA LOW POWER COMPLIANT
2.7	24
3	30
3.3	36

RECOMMENDED SOLDER PROFILES

Solder Profile for Sn/Pb Soldering



Fig. 2 - Recommended Solder Profile for Sn/Pb Soldering

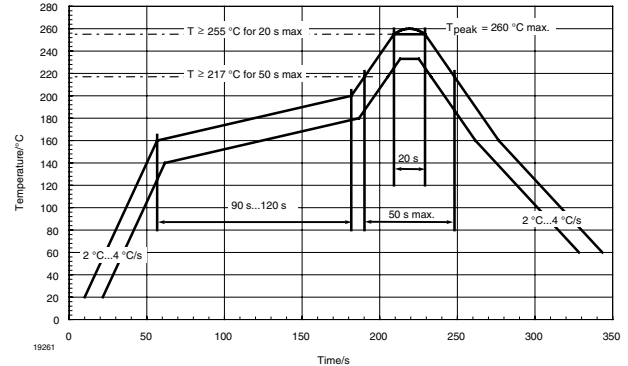

Fig. 3 - Solder Profile, RSS Recommendation

Lead (Pb)-free, Recommended Solder Profile

The TFBS4650 is a lead (Pb)-free transceiver and qualified for lead (Pb)-free processing. For lead (Pb)-free solder paste like $\text{Sn}_{(3.0 - 4.0)}\text{Ag}_{(0.5 - 0.9)}\text{Cu}$, there are two standard reflow profiles: Ramp-Soak-Spike (RSS) and Ramp-To-Spike (RTS). The Ramp-Soak-Spike profile was developed primarily for reflow ovens heated by infrared radiation. With widespread use of forced convection reflow ovens the Ramp-To-Spike profile is used increasingly. Shown in figure 3 is Vishay's recommended profiles for use with the TFBS4650 transceivers. For more details please refer to the application note "SMD Assembly Instructions".

Wave Soldering

For TFDUxxxx and TFBSxxxx transceiver devices wave soldering is not recommended.

Manual Soldering

Manual soldering is the standard method for lab use. However, for a production process it cannot be recommended because the risk of damage is highly dependent on the experience of the operator. Nevertheless, we added a chapter to the above mentioned application note, describing manual soldering and desoldering.

Storage

The storage and drying processes for all Vishay transceivers (TFDUxxxx and TFBSxxxx) are equivalent to MSL4.

The data for the drying procedure is given on labels on the packing and also in the application note "Taping, Labeling, Storage and Packing".

PACKAGE DIMENSIONS in millimeters



Tolerances ± 0.2

Drawing-No.: 6.550-5268.01-4

Issue: 2; 06.03.06

19322

Fig. 4 - TFBS4650 Mechanical Dimensions, Tolerance ± 0.2 mm, if not otherwise mentioned



Fig. 5 - TFBS4650 Soldering Footprint, Tolerance ± 0.2 mm, if not otherwise mentioned

REEL DIMENSIONS in millimeters

Drawing-No.: 9.800-5090.01-4
 Issue: 1; 29.11.05
 14017

Form of the leave open
 of the wheel is supplier specific.

Dimension acc. to IEC EN 60 286-3

Technical drawings
 according to DIN
 specifications

TAPE WIDTH (mm)	A MAX. (mm)	N (mm)	W ₁ MIN. (mm)	W ₂ MAX. (mm)	W ₃ MIN. (mm)	W ₃ MAX. (mm)
16	330	50	16.4	22.4	15.9	19.4

TAPE DIMENSIONS FOR TR1 AND TR3 in millimeters

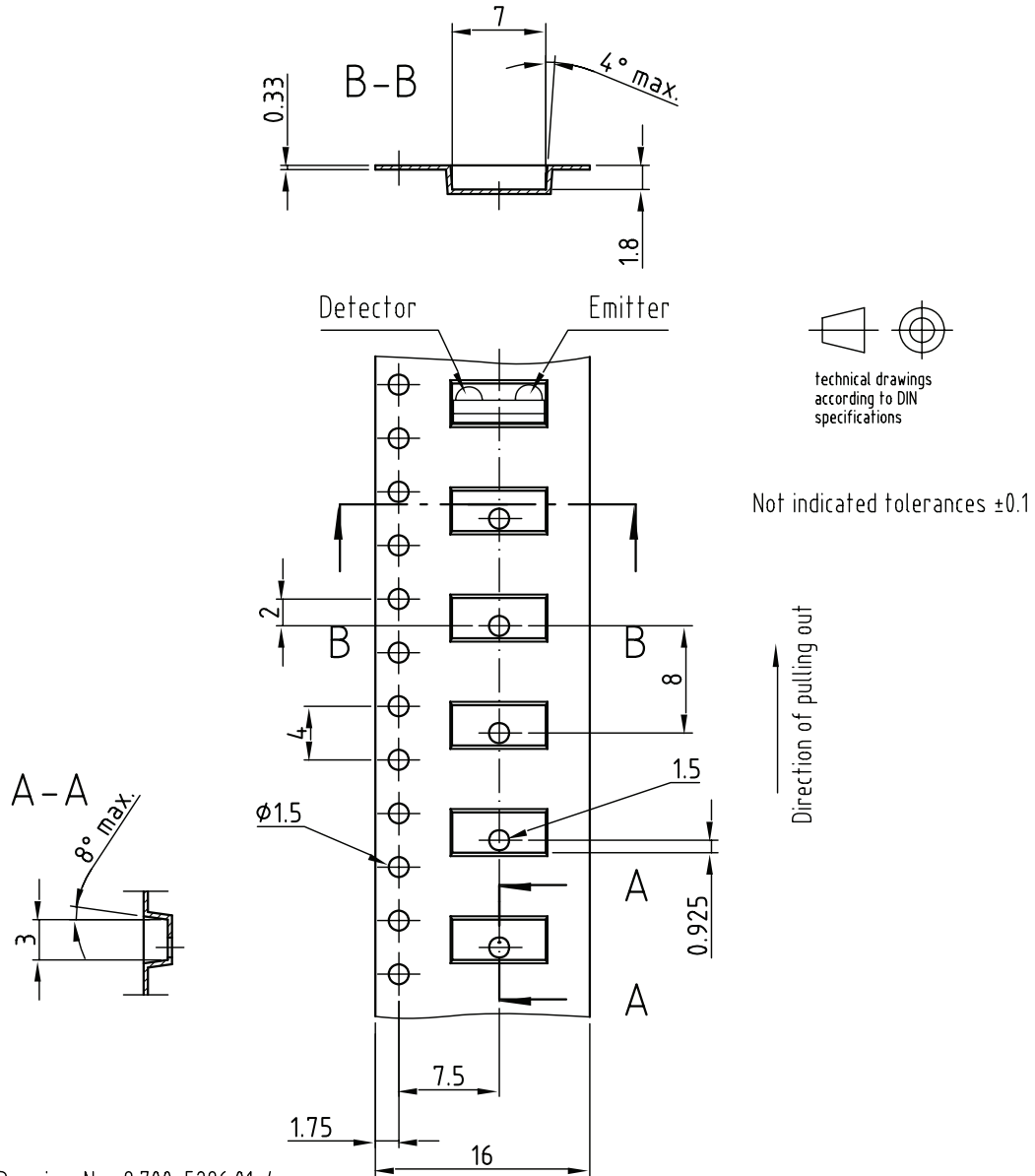

Drawing-No.: 9.700-5296.01-4
 Issue: 1; 08.12.04
 19783

TFBS4650

Vishay Semiconductors Infrared Transceiver, 9.6 kbit/s to 115.2 kbit/s (SIR)



TAPE DIMENSIONS FOR TT3 in millimeters



Drawing-No.: 9.700-5340.01-4
Issue: 1; 15.01.09
21663



Disclaimer

ALL PRODUCT, PRODUCT SPECIFICATIONS AND DATA ARE SUBJECT TO CHANGE WITHOUT NOTICE TO IMPROVE RELIABILITY, FUNCTION OR DESIGN OR OTHERWISE.

Vishay Intertechnology, Inc., its affiliates, agents, and employees, and all persons acting on its or their behalf (collectively, "Vishay"), disclaim any and all liability for any errors, inaccuracies or incompleteness contained in any datasheet or in any other disclosure relating to any product.

Vishay makes no warranty, representation or guarantee regarding the suitability of the products for any particular purpose or the continuing production of any product. To the maximum extent permitted by applicable law, Vishay disclaims (i) any and all liability arising out of the application or use of any product, (ii) any and all liability, including without limitation special, consequential or incidental damages, and (iii) any and all implied warranties, including warranties of fitness for particular purpose, non-infringement and merchantability.

Statements regarding the suitability of products for certain types of applications are based on Vishay's knowledge of typical requirements that are often placed on Vishay products in generic applications. Such statements are not binding statements about the suitability of products for a particular application. It is the customer's responsibility to validate that a particular product with the properties described in the product specification is suitable for use in a particular application. Parameters provided in datasheets and/or specifications may vary in different applications and performance may vary over time. All operating parameters, including typical parameters, must be validated for each customer application by the customer's technical experts. Product specifications do not expand or otherwise modify Vishay's terms and conditions of purchase, including but not limited to the warranty expressed therein.

Except as expressly indicated in writing, Vishay products are not designed for use in medical, life-saving, or life-sustaining applications or for any other application in which the failure of the Vishay product could result in personal injury or death. Customers using or selling Vishay products not expressly indicated for use in such applications do so at their own risk. Please contact authorized Vishay personnel to obtain written terms and conditions regarding products designed for such applications.

No license, express or implied, by estoppel or otherwise, to any intellectual property rights is granted by this document or by any conduct of Vishay. Product names and markings noted herein may be trademarks of their respective owners.

Material Category Policy

Vishay Intertechnology, Inc. hereby certifies that all its products that are identified as RoHS-Compliant fulfill the definitions and restrictions defined under Directive 2011/65/EU of The European Parliament and of the Council of June 8, 2011 on the restriction of the use of certain hazardous substances in electrical and electronic equipment (EEE) - recast, unless otherwise specified as non-compliant.

Please note that some Vishay documentation may still make reference to RoHS Directive 2002/95/EC. We confirm that all the products identified as being compliant to Directive 2002/95/EC conform to Directive 2011/65/EU.

Vishay Intertechnology, Inc. hereby certifies that all its products that are identified as Halogen-Free follow Halogen-Free requirements as per JEDEC JS709A standards. Please note that some Vishay documentation may still make reference to the IEC 61249-2-21 definition. We confirm that all the products identified as being compliant to IEC 61249-2-21 conform to JEDEC JS709A standards.

Компания «Океан Электроники» предлагает заключение долгосрочных отношений при поставках импортных электронных компонентов на взаимовыгодных условиях!

Наши преимущества:

- Поставка оригинальных импортных электронных компонентов напрямую с производств Америки, Европы и Азии, а так же с крупнейших складов мира;
- Широкая линейка поставок активных и пассивных импортных электронных компонентов (более 30 млн. наименований);
- Поставка сложных, дефицитных, либо снятых с производства позиций;
- Оперативные сроки поставки под заказ (от 5 рабочих дней);
- Экспресс доставка в любую точку России;
- Помощь Конструкторского Отдела и консультации квалифицированных инженеров;
- Техническая поддержка проекта, помощь в подборе аналогов, поставка прототипов;
- Поставка электронных компонентов под контролем ВП;
- Система менеджмента качества сертифицирована по Международному стандарту ISO 9001;
- При необходимости вся продукция военного и аэрокосмического назначения проходит испытания и сертификацию в лаборатории (по согласованию с заказчиком);
- Поставка специализированных компонентов военного и аэрокосмического уровня качества (Xilinx, Altera, Analog Devices, Intersil, Interpoint, Microsemi, Actel, Aeroflex, Peregrine, VPT, Syfer, Eurofarad, Texas Instruments, MS Kennedy, Miteq, Cobham, E2V, MA-COM, Hittite, Mini-Circuits, General Dynamics и др.);

Компания «Океан Электроники» является официальным дистрибьютором и эксклюзивным представителем в России одного из крупнейших производителей разъемов военного и аэрокосмического назначения «JONHON», а так же официальным дистрибьютором и эксклюзивным представителем в России производителя высокотехнологичных и надежных решений для передачи СВЧ сигналов «FORSTAR».



JONHON

«JONHON» (основан в 1970 г.)

Разъемы специального, военного и аэрокосмического назначения:

(Применяются в военной, авиационной, аэрокосмической, морской, железнодорожной, горно- и нефтедобывающей отраслях промышленности)

«FORSTAR» (основан в 1998 г.)

ВЧ соединители, коаксиальные кабели, кабельные сборки и микроволновые компоненты:

(Применяются в телекоммуникациях гражданского и специального назначения, в средствах связи, РЛС, а так же военной, авиационной и аэрокосмической отраслях промышленности).



Телефон: 8 (812) 309-75-97 (многоканальный)

Факс: 8 (812) 320-03-32

Электронная почта: ocean@oceanchips.ru

Web: <http://oceanchips.ru/>

Адрес: 198099, г. Санкт-Петербург, ул. Калинина, д. 2, корп. 4, лит. А