



Is Now Part of



ON Semiconductor®

To learn more about ON Semiconductor, please visit our website at
www.onsemi.com

Please note: As part of the Fairchild Semiconductor integration, some of the Fairchild orderable part numbers will need to change in order to meet ON Semiconductor's system requirements. Since the ON Semiconductor product management systems do not have the ability to manage part nomenclature that utilizes an underscore (_), the underscore (_) in the Fairchild part numbers will be changed to a dash (-). This document may contain device numbers with an underscore (_). Please check the ON Semiconductor website to verify the updated device numbers. The most current and up-to-date ordering information can be found at www.onsemi.com. Please email any questions regarding the system integration to Fairchild_questions@onsemi.com.

ON Semiconductor and the ON Semiconductor logo are trademarks of Semiconductor Components Industries, LLC dba ON Semiconductor or its subsidiaries in the United States and/or other countries. ON Semiconductor owns the rights to a number of patents, trademarks, copyrights, trade secrets, and other intellectual property. A listing of ON Semiconductor's product/patent coverage may be accessed at www.onsemi.com/site/pdf/Patent-Marking.pdf. ON Semiconductor reserves the right to make changes without further notice to any products herein. ON Semiconductor makes no warranty, representation or guarantee regarding the suitability of its products for any particular purpose, nor does ON Semiconductor assume any liability arising out of the application or use of any product or circuit, and specifically disclaims any and all liability, including without limitation special, consequential or incidental damages. Buyer is responsible for its products and applications using ON Semiconductor products, including compliance with all laws, regulations and safety requirements or standards, regardless of any support or applications information provided by ON Semiconductor. "Typical" parameters which may be provided in ON Semiconductor data sheets and/or specifications can and do vary in different applications and actual performance may vary over time. All operating parameters, including "Typicals" must be validated for each customer application by customer's technical experts. ON Semiconductor does not convey any license under its patent rights nor the rights of others. ON Semiconductor products are not designed, intended, or authorized for use as a critical component in life support systems or any FDA Class 3 medical devices or medical devices with a same or similar classification in a foreign jurisdiction or any devices intended for implantation in the human body. Should Buyer purchase or use ON Semiconductor products for any such unintended or unauthorized application, Buyer shall indemnify and hold ON Semiconductor and its officers, employees, subsidiaries, affiliates, and distributors harmless against all claims, costs, damages, and expenses, and reasonable attorney fees arising out of, directly or indirectly, any claim of personal injury or death associated with such unintended or unauthorized use, even if such claim alleges that ON Semiconductor was negligent regarding the design or manufacture of the part. ON Semiconductor is an Equal Opportunity/Affirmative Action Employer. This literature is subject to all applicable copyright laws and is not for resale in any manner.



September 2016

H11N1M, H11N2M — 6-Pin DIP Schmitt Trigger Output Optocoupler

H11N1M, H11N2M 6-Pin DIP Schmitt Trigger Output Optocoupler

Features

- High Data Rate, 5 MHz Typical (NRZ)
- Free from Latch-up and Oscillation Throughout Voltage and Temperature Ranges
- Microprocessor Compatible Drive
- Logic Compatible Output Sinks 16 mA at 0.5 V Maximum
- Guaranteed On/Off Threshold Hysteresis
- Wide Supply Voltage Capability, Compatible with All Popular Logic Systems
- Safety and Regulatory Approvals:
 - UL1577, 4,170 VAC_{RMS} for 1 Minute
 - DIN-EN/IEC60747-5-5, 850 V Peak Working Insulation Voltage

Description

The H11NXM series has a high-speed integrated circuit detector optically coupled to an aluminium gallium arsenide (AlGaAs) infrared emitting diode. The output incorporates a Schmitt trigger, which provides hysteresis for noise immunity and pulse shaping. The detector circuit is optimized for simplicity of operation and utilizes an open-collector output for maximum application flexibility.

Applications

- Logic-to-Logic Isolator
- Programmable Current Level Sensor
- Line Receiver—Eliminate Noise and Transient Problems
- AC to TTL Conversion—Square Wave Shaping
- Interfaces Computers with Peripherals
- Isolated Power MOS Driver for Power Supplies

Schematic

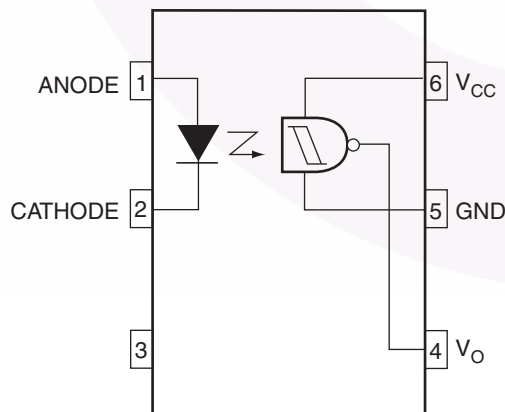

Figure 1. Schematic

Package Outlines



Figure 2. Package Outlines

Truth Table

Input	Output
H	L
L	H

Safety and Insulation Ratings

As per DIN EN/IEC 60747-5-5, this optocoupler is suitable for “safe electrical insulation” only within the safety limit data. Compliance with the safety ratings shall be ensured by means of protective circuits.

Parameter		Characteristics
Installation Classifications per DIN VDE 0110/1.89 Table 1, For Rated Mains Voltage	< 150 V _{RMS}	I–IV
	< 300 V _{RMS}	I–IV
Climatic Classification		55/100/21
Pollution Degree (DIN VDE 0110/1.89)		2
Comparative Tracking Index		175

Symbol	Parameter	Value	Unit
V _{PR}	Input-to-Output Test Voltage, Method A, V _{IORM} × 1.6 = V _{PR} , Type and Sample Test with t _m = 10 s, Partial Discharge < 5 pC	1360	V _{peak}
	Input-to-Output Test Voltage, Method B, V _{IORM} × 1.875 = V _{PR} , 100% Production Test with t _m = 1 s, Partial Discharge < 5 pC	1594	V _{peak}
V _{IORM}	Maximum Working Insulation Voltage	850	V _{peak}
V _{IOTM}	Highest Allowable Over-Voltage	6000	V _{peak}
	External Creepage	≥ 7	mm
	External Clearance	≥ 7	mm
	External Clearance (for Option TV, 0.4" Lead Spacing)	≥ 10	mm
DTI	Distance Through Insulation (Insulation Thickness)	≥ 0.5	mm
T _S	Case Temperature ⁽¹⁾	175	°C
I _{S,INPUT}	Input Current ⁽¹⁾	350	mA
P _{S,OUTPUT}	Output Power ⁽¹⁾	800	mW
R _{IO}	Insulation Resistance at T _S , V _{IO} = 500 V ⁽¹⁾	> 10 ⁹	Ω

Note:

1. Safety limit values – maximum values allowed in the event of a failure.

Absolute Maximum Ratings

Stresses exceeding the absolute maximum ratings may damage the device. The device may not function or be operable above the recommended operating conditions and stressing the parts to these levels is not recommended. In addition, extended exposure to stresses above the recommended operating conditions may affect device reliability. The absolute maximum ratings are stress ratings only. $T_A = 25^\circ\text{C}$ unless otherwise specified.

Symbol	Parameters	Value	Units
Total Device			
T_{STG}	Storage Temperature	-40 to +125	$^\circ\text{C}$
T_{OPR}	Operating Temperature	-40 to +85	$^\circ\text{C}$
T_J	Junction Temperature	-40 to +125	$^\circ\text{C}$
T_{SOL}	Lead Solder Temperature	260 for 10 seconds	$^\circ\text{C}$
P_D	Total Device Power Dissipation at 25°C Derate Above 25°C	210	mW
		2.94	mW/ $^\circ\text{C}$
Emitter			
I_F	Continuous Forward Current	30	mA
V_R	Reverse Voltage	6	V
$I_F(\text{pk})$	Forward Current – Peak (1 μs pulse, 300 pps)	100	mA
P_D	LED Power Dissipation	60	mW
Detector			
P_D	Detector Power Dissipation	150	mW
V_O	V_{45} Allowed Range	0 to 16	V
V_{CC}	V_{65} Allowed Range	3 to 16	V
I_O	I_4 Output Current	50	mA

Electrical Characteristics

$T_A = 25^\circ\text{C}$ unless otherwise specified.

Individual Component Characteristics

Symbol	Parameters	Test Conditions	Min.	Typ.	Max.	Units
Emitter						
V_F	Input Forward Voltage	$I_F = 10\text{ mA}$		1.4	2.0	V
		$I_F = 0.3\text{ mA}$	0.75	1.25		
I_R	Reverse Current	$V_R = 5\text{ V}$			10	μA
C_J	Capacitance	$V = 0, f = 1.0\text{ MHz}$			100	pF
Detector						
V_{CC}	Operating Voltage Range		4		15	V
$I_{\text{CC(off)}}$	Supply Current	$I_F = 0, V_{\text{CC}} = 5\text{ V}$		6	10	mA
I_{OH}	Output Current, High	$I_F = 0, V_{\text{CC}} = V_O = 15\text{ V}$			100	μA

Electrical Characteristics (Continued) $T_A = 25^\circ\text{C}$ unless otherwise specified.**Transfer Characteristics**

Symbol	DC Characteristics	Test Conditions	Device	Min.	Typ.	Max.	Units
$I_{CC(on)}$	Supply Current	$I_F = 10\text{ mA}$, $V_{CC} = 5\text{ V}$	All		6.5	10.0	mA
V_{OL}	Output Voltage, Low	$R_L = 270\ \Omega$, $V_{CC} = 5\text{ V}$, $I_F = I_{F(on)}$ Maximum	All			0.5	V
$I_{F(on)}$	Turn-On Threshold Current	$R_L = 270\ \Omega$, $V_{CC} = 5\text{ V}^{(2)}$	H11N1M	0.8		3.2	mA
			H11N2M	2.3		5.0	
$I_{F(off)}$	Turn-Off Threshold Current	$R_L = 270\ \Omega$, $V_{CC} = 5\text{ V}$	All	0.3			mA
$I_{F(off)} / I_{F(on)}$	Hysteresis Ratio	$R_L = 270\ \Omega$, $V_{CC} = 5\text{ V}$	All	0.65		0.95	

Switching Speed

Symbol	AC Characteristics	Test Conditions	Min.	Typ.	Max.	Units
t_{on}	Turn-On Time	$C = 120\text{ pF}$, $t_p = 1\ \mu\text{s}$, $R_E = ^{(3)}$, Figure 9		100	330	ns
t_r	Rise Time	$C = 120\text{ pF}$, $t_p = 1\ \mu\text{s}$, $R_E = ^{(3)}$, Figure 9		7.5		ns
t_{off}	Turn-Off Time	$C = 120\text{ pF}$, $t_p = 1\ \mu\text{s}$, $R_E = ^{(3)}$, Figure 9		150	330	ns
t_f	Fall Time	$C = 120\text{ pF}$, $t_p = 1\ \mu\text{s}$, $R_E = ^{(3)}$, Figure 9		12		ns
	Data Rate			5		MHz

Isolation Characteristics

Symbol	Parameters	Test Conditions	Min.	Typ.	Max.	Units
V_{ISO}	Input-Output Isolation Voltage	$t = 1\text{ Minute}$	4170			$V_{AC(RMS)}$
C_{ISO}	Isolation Capacitance	$V_{I-O} = 0\text{ V}$, $f = 1\text{ MHz}$		0.4	0.6	pF
R_{ISO}	Isolation Resistance	$V_{I-O} = \pm 500\text{ VDC}$, $T_A = 25^\circ\text{C}$	10^{11}			Ω

Notes:

- Maximum $I_{F(on)}$ is the maximum current required to trigger the output. For example, a 3.2 mA maximum trigger current would require the LED to be driven at a current greater than 3.2 mA to guarantee the device will turn on. A 10% guard band is recommended to account for degradation of the LED over its lifetime. The maximum allowable LED drive current is 30 mA.
- H11N1: $R_E = 910\ \Omega$, H11N2: $R_E = 560\ \Omega$

Typical Performance Curves

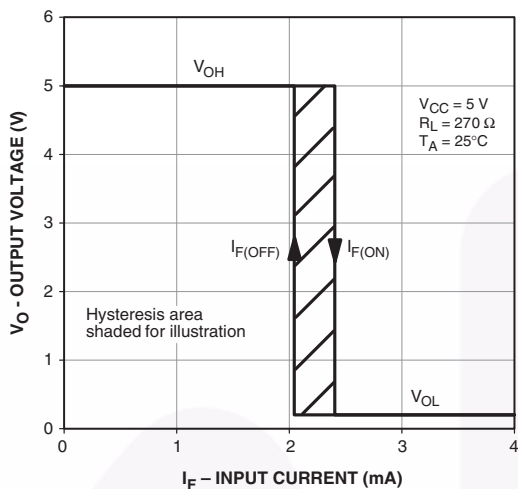

Figure 3. Transfer Characteristics

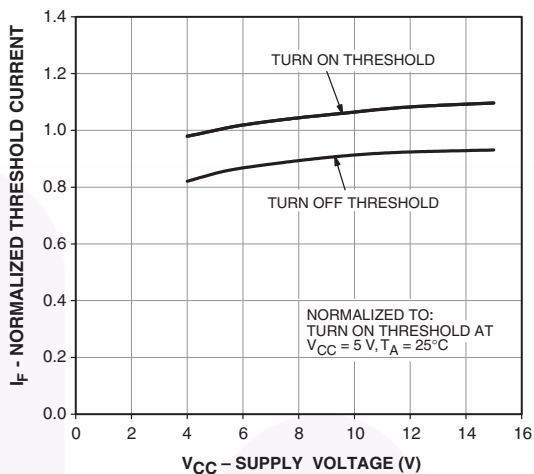

Figure 4. Threshold Current vs. Supply Voltage

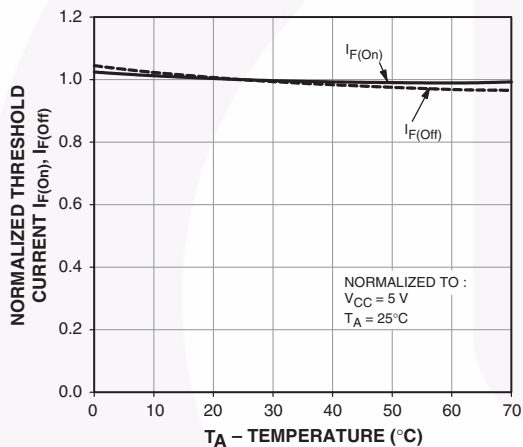

Figure 5. Threshold Current vs. Temperature

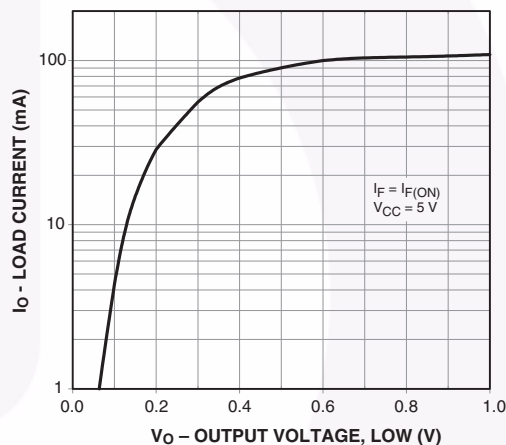

Figure 6. Load Current vs. Output Voltage

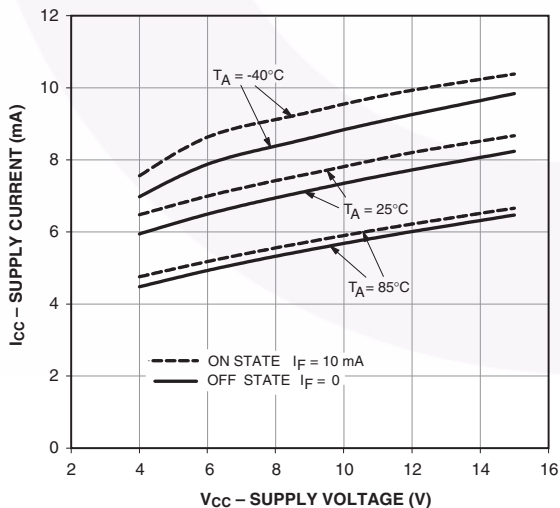

Figure 7. Supply Current vs. Supply Voltage

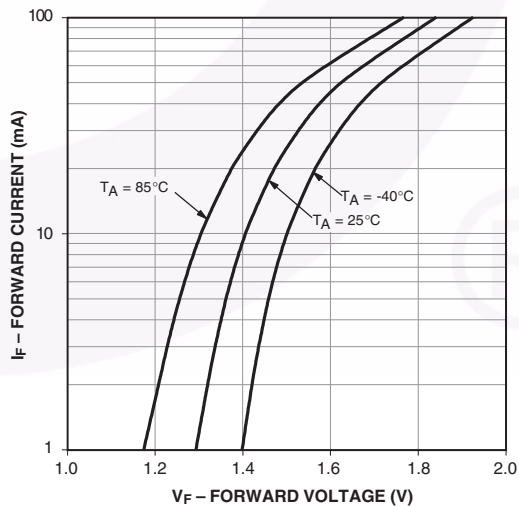

Figure 8. LED Forward Current vs. Forward Voltage

Switching Test Circuit and Waveforms



Figure 9. Switching Test Circuit and Waveforms

Reflow Profile

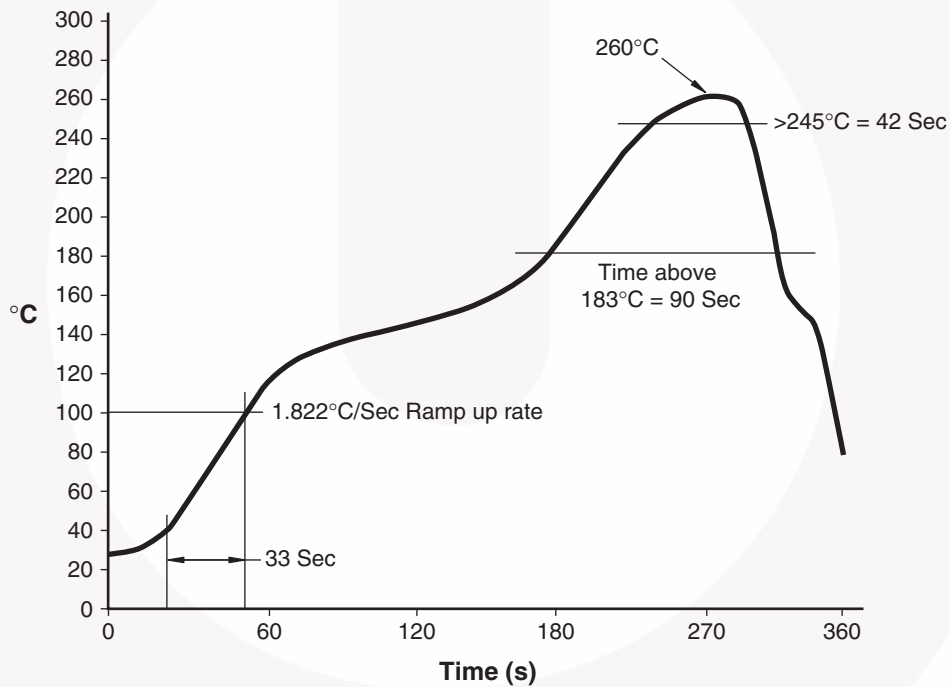

Figure 10. Reflow Profile

Ordering Information

Part Number	Package	Packing Method
H11N1M	DIP 6-Pin	Tube (50 Units)
H11N1SM	SMT 6-Pin (Lead Bend)	Tube (50 Units)
H11N1SR2M	SMT 6-Pin (Lead Bend)	Tape and Reel (1000 Units)
H11N1VM	DIP 6-Pin, DIN EN/IEC60747-5-5 Option	Tube (50 Units)
H11N1SVM	SMT 6-Pin (Lead Bend), DIN EN/IEC60747-5-5 Option	Tube (50 Units)
H11N1SR2VM	SMT 6-Pin (Lead Bend), DIN EN/IEC60747-5-5 Option	Tape and Reel (1000 Units)
H11N1TVM	DIP 6-Pin, 0.4" Lead Spacing, DIN EN/IEC60747-5-5 Option	Tube (50 Units)

Note:

4. The product orderable part number system listed in this table also applies to the H11N2M product families.

Marking Information



Figure 11. Top Mark

Table 1. Top Mark Definitions

1	Fairchild Logo
2	Device Number
3	DIN EN/IEC60747-5-5 Option (only appears on component ordered with this option)
4	One-Digit Year Code, e.g., "6"
5	Digit Work Week, Ranging from "01" to "53"
6	Assembly Package Code



- NOTES:
- A) NO STANDARD APPLIES TO THIS PACKAGE.
 - B) ALL DIMENSIONS ARE IN MILLIMETERS.
 - C) DIMENSIONS ARE EXCLUSIVE OF BURRS, MOLD FLASH, AND TIE BAR EXTRUSION
 - D) DRAWING FILENAME AND REVISION: MKT-N06BREV4.





LAND PATTERN RECOMMENDATION



NOTES:

- A) NO STANDARD APPLIES TO THIS PACKAGE.
- B) ALL DIMENSIONS ARE IN MILLIMETERS.
- C) DIMENSIONS ARE EXCLUSIVE OF BURRS, MOLD FLASH, AND TIE BAR EXTRUSION
- D) DRAWING FILENAME AND REVISION : MKT-N06CREV4.





NOTES:

- A) NO STANDARD APPLIES TO THIS PACKAGE.
- B) ALL DIMENSIONS ARE IN MILLIMETERS.
- C) DIMENSIONS ARE EXCLUSIVE OF BURRS, MOLD FLASH, AND TIE BAR EXTRUSION
- D) DRAWING FILENAME AND REVISION: MKT-N06Drev4



ON Semiconductor and  are trademarks of Semiconductor Components Industries, LLC dba ON Semiconductor or its subsidiaries in the United States and/or other countries. ON Semiconductor owns the rights to a number of patents, trademarks, copyrights, trade secrets, and other intellectual property. A listing of ON Semiconductor's product/patent coverage may be accessed at www.onsemi.com/site/pdf/Patent-Marking.pdf. ON Semiconductor reserves the right to make changes without further notice to any products herein. ON Semiconductor makes no warranty, representation or guarantee regarding the suitability of its products for any particular purpose, nor does ON Semiconductor assume any liability arising out of the application or use of any product or circuit, and specifically disclaims any and all liability, including without limitation special, consequential or incidental damages. Buyer is responsible for its products and applications using ON Semiconductor products, including compliance with all laws, regulations and safety requirements or standards, regardless of any support or applications information provided by ON Semiconductor. "Typical" parameters which may be provided in ON Semiconductor data sheets and/or specifications can and do vary in different applications and actual performance may vary over time. All operating parameters, including "Typicals" must be validated for each customer application by customer's technical experts. ON Semiconductor does not convey any license under its patent rights nor the rights of others. ON Semiconductor products are not designed, intended, or authorized for use as a critical component in life support systems or any FDA Class 3 medical devices or medical devices with a same or similar classification in a foreign jurisdiction or any devices intended for implantation in the human body. Should Buyer purchase or use ON Semiconductor products for any such unintended or unauthorized application, Buyer shall indemnify and hold ON Semiconductor and its officers, employees, subsidiaries, affiliates, and distributors harmless against all claims, costs, damages, and expenses, and reasonable attorney fees arising out of, directly or indirectly, any claim of personal injury or death associated with such unintended or unauthorized use, even if such claim alleges that ON Semiconductor was negligent regarding the design or manufacture of the part. ON Semiconductor is an Equal Opportunity/Affirmative Action Employer. This literature is subject to all applicable copyright laws and is not for resale in any manner.

PUBLICATION ORDERING INFORMATION

LITERATURE FULFILLMENT:

Literature Distribution Center for ON Semiconductor
19521 E. 32nd Pkwy, Aurora, Colorado 80011 USA
Phone: 303-675-2175 or 800-344-3860 Toll Free USA/Canada
Fax: 303-675-2176 or 800-344-3867 Toll Free USA/Canada
Email: orderlit@onsemi.com

N. American Technical Support: 800-282-9855 Toll Free
USA/Canada
Europe, Middle East and Africa Technical Support:
Phone: 421 33 790 2910
Japan Customer Focus Center
Phone: 81-3-5817-1050

ON Semiconductor Website: www.onsemi.com
Order Literature: <http://www.onsemi.com/orderlit>
For additional information, please contact your local
Sales Representative

Mouser Electronics

Authorized Distributor

Click to View Pricing, Inventory, Delivery & Lifecycle Information:

[ON Semiconductor:](#)

[H11N1SR2VM](#) [H11N1SVM](#) [H11N1M](#) [H11N1TVM](#) [H11N1VM](#) [H11N1SM](#) [H11N1SR2M](#)

Компания «Океан Электроники» предлагает заключение долгосрочных отношений при поставках импортных электронных компонентов на взаимовыгодных условиях!

Наши преимущества:

- Поставка оригинальных импортных электронных компонентов напрямую с производств Америки, Европы и Азии, а так же с крупнейших складов мира;
- Широкая линейка поставок активных и пассивных импортных электронных компонентов (более 30 млн. наименований);
- Поставка сложных, дефицитных, либо снятых с производства позиций;
- Оперативные сроки поставки под заказ (от 5 рабочих дней);
- Экспресс доставка в любую точку России;
- Помощь Конструкторского Отдела и консультации квалифицированных инженеров;
- Техническая поддержка проекта, помощь в подборе аналогов, поставка прототипов;
- Поставка электронных компонентов под контролем ВП;
- Система менеджмента качества сертифицирована по Международному стандарту ISO 9001;
- При необходимости вся продукция военного и аэрокосмического назначения проходит испытания и сертификацию в лаборатории (по согласованию с заказчиком);
- Поставка специализированных компонентов военного и аэрокосмического уровня качества (Xilinx, Altera, Analog Devices, Intersil, Interpoint, Microsemi, Actel, Aeroflex, Peregrine, VPT, Syfer, Eurofarad, Texas Instruments, MS Kennedy, Miteq, Cobham, E2V, MA-COM, Hittite, Mini-Circuits, General Dynamics и др.);

Компания «Океан Электроники» является официальным дистрибьютором и эксклюзивным представителем в России одного из крупнейших производителей разъемов военного и аэрокосмического назначения «JONHON», а так же официальным дистрибьютором и эксклюзивным представителем в России производителя высокотехнологичных и надежных решений для передачи СВЧ сигналов «FORSTAR».



JONHON

«JONHON» (основан в 1970 г.)

Разъемы специального, военного и аэрокосмического назначения:

(Применяются в военной, авиационной, аэрокосмической, морской, железнодорожной, горно- и нефтедобывающей отраслях промышленности)

«FORSTAR» (основан в 1998 г.)

ВЧ соединители, коаксиальные кабели, кабельные сборки и микроволновые компоненты:

(Применяются в телекоммуникациях гражданского и специального назначения, в средствах связи, РЛС, а так же военной, авиационной и аэрокосмической отраслях промышленности).



Телефон: 8 (812) 309-75-97 (многоканальный)

Факс: 8 (812) 320-03-32

Электронная почта: ocean@oceanchips.ru

Web: <http://oceanchips.ru/>

Адрес: 198099, г. Санкт-Петербург, ул. Калинина, д. 2, корп. 4, лит. А