

# HLMP-132x Series, HLMP-142x Series, HLMP-152x Series



T-1 (3 mm) High Intensity LED Lamps

## Data Sheet



### Description

This family of T-1 lamps is specially designed for applications requiring higher on-axis intensity than is achievable with a standard lamp. The light generated is focused to a narrow beam to achieve this effect.

### Features

- High intensity
- Choice of 3 bright colors
  - High Efficiency Red
  - Yellow
  - High Performance Green
- Popular T-1 diameter package
- Selected minimum intensities
- Narrow viewing angle
- General purpose leads
- Reliable and rugged
- Available on tape and reel
- For more information, please refer to Tape and Reel Option data sheet

### Package Dimensions

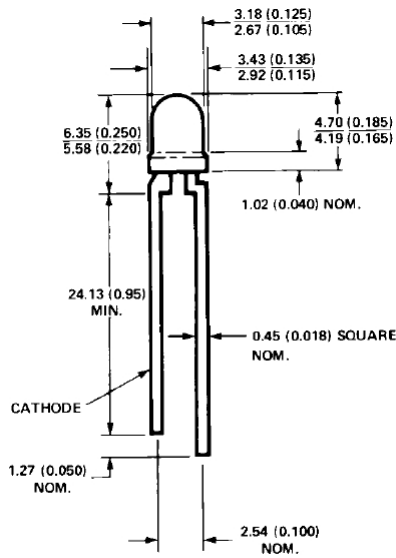

NOTES:  
1. ALL DIMENSIONS ARE IN MILLIMETRES (INCHES).  
2. AN EPOXY MENISCUS MAY EXTEND ABOUT 1mm (0.040") DOWN THE LEADS.

### Selection Guide

Part Number	Package Description	Color	Luminous Intensity Iv (mcd) @ 10 mA	
			Min.	Max.
HLMP-1321	Tinted, Non-diffused	High Efficiency Red	8.6	-
HLMP-1321-G00xx			8.6	-
HLMP-1420	Microtinted, Non-diffused	Yellow	9.2	-
HLMP-1421	Tinted, Non-diffused		9.2	-
HLMP-1421-F00xx			9.2	-
HLMP-1520	Microtinted, Non-diffused	Green	6.7	-
HLMP-1521	Tinted, Non-diffused		6.7	-
HLMP-1521-E00xx			6.7	-

## Part Numbering System

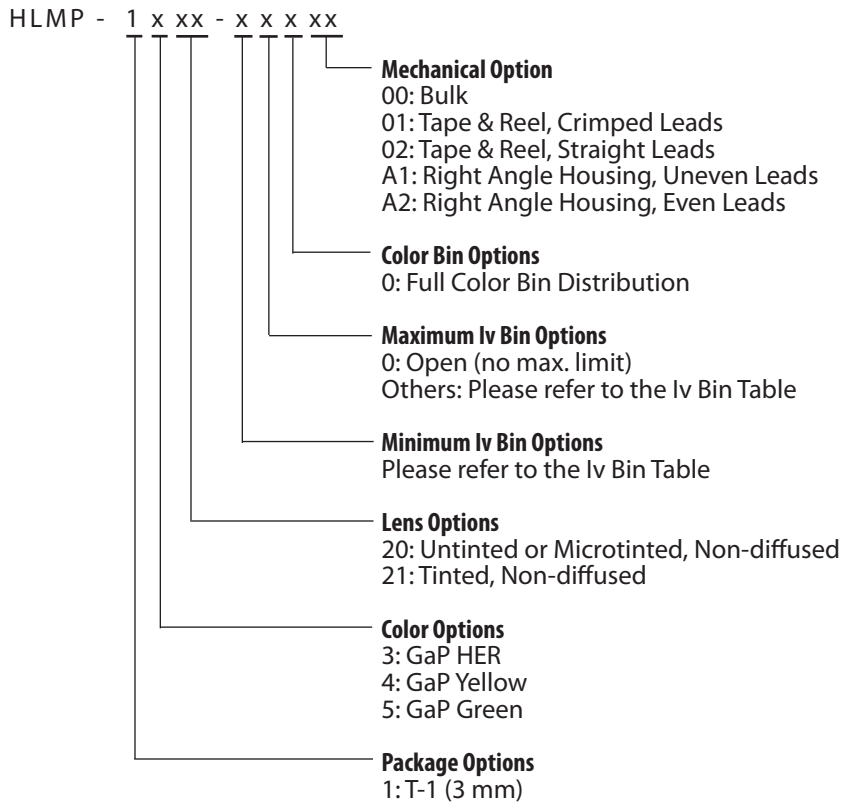

## Absolute Maximum Ratings at $T_A = 25^\circ\text{C}$

Parameter	Red	Yellow	Green	Units
Peak Forward Current	90	60	90	mA
Average Forward Current <sup>[1]</sup>	25	20	25	mA
DC Current <sup>[2]</sup>	30	20	30	mA
Power Dissipation <sup>[3]</sup>	135	85	135	mW
Reverse Voltage ( $I_R = 100 \mu\text{A}$ )	5	5	5	V
Transient Forward Current <sup>[4]</sup> (10 $\mu\text{sec}$ Pulse)	500	500	500	mA
LED Junction Temperature	110	110	110	$^\circ\text{C}$
Operating Temperature Range	-40 to +100	-40 to +100	-20 to +100	$^\circ\text{C}$
Storage Temperature Range	-40 to +100	-40 to +100	-40 to +100	

### Notes:

- See Figure 5 (Red), 10 (Yellow), or 15 (Green) to establish pulsed operating conditions.
- For Red and Green series derate linearly from  $50^\circ\text{C}$  at  $0.5 \text{ mA}/^\circ\text{C}$ . For Yellow series derate linearly from  $50^\circ\text{C}$  at  $0.2 \text{ mA}/^\circ\text{C}$ .
- For Red and Green series derate power linearly from  $25^\circ\text{C}$  at  $1.8 \text{ mW}/^\circ\text{C}$ . For Yellow series derate power linearly from  $50^\circ\text{C}$  at  $1.6 \text{ mW}/^\circ\text{C}$ .
- The transient peak current is the maximum non-recurring peak current that can be applied to the device without damaging the LED die and wirebond. It is not recommended that the device be operated at peak currents beyond the peak forward current listed in the Absolute Maximum Ratings.

## Electrical Characteristics at $T_A = 25^\circ\text{C}$

Symbol	Description	Device			Units	Test Conditions	
		HLMP-	Min.	Typ.			Max.
$I_V$	Luminous Intensity	1320	8.6	30	mcd	$I_F = 10\text{ mA}$ (Figure 3)	
		1321	8.6	30			
		1420	9.2	15	mcd	$I_F = 10\text{ mA}$ (Figure 8)	
		1421	9.2	15			
		1520	6.7	22	mcd	$I_F = 10\text{ mA}$ (Figure 3)	
1521	6.7	22					
$2\theta^{1/2}$	Including Angle Between Half Luminous Intensity Points	All		45	Deg.	$I_F = 10\text{ mA}$ See Note 1 (Figures 6, 11, 16, 21)	
$\lambda_{\text{PEAK}}$	Peak Wavelength	132x		635	nm	Measurement at Peak (Figure 1)	
		142X		583			
		152X		565			
$\Delta\lambda_{1/2}$	Spectral Line Halfwidth	132x		40	nm		
		142X		36			
		152X		28			
$\lambda_d$	Dominant Wavelength	132x		626	nm	See Note 2 (Figure 1)	
		142X		585			
		152X		569			
$\tau_s$	Speed of Response	132x		90	ns		
		142X		90			
		152X		500			
C	Capacitance	132x		11	pF	$V_F = 0; f = 1\text{ MHz}$	
		142X		15			
		152X		18			
$R\theta_{\text{J-PIN}}$	Thermal Resistance	All		290	$^\circ\text{C/W}$	Junction to Cathode Lead	
$V_F$	Forward Voltage	132x		1.9	2.4	V	$I_F = 10\text{ mA}$
		142X		2.0	2.4		
		152X		2.1	2.7		
$V_R$	Reverse Breakdown Voltage	All	5.0			V	$I_R = 100\ \mu\text{A}$
$\eta_V$	Luminous Efficacy	132x		145		$\frac{\text{lumens}}{\text{watt}}$	See Note 3
		142X		500			
		152X		595			

### Notes:

- $\theta^{1/2}$  is the off-axis angle at which the luminous intensity is half the axial luminous intensity.
- The dominant wavelength,  $\lambda_d$ , is derived from the CIE chromaticity diagram and represents the single wavelength which defines the color of the device.
- Radiant intensity,  $I_e$ , in watts/steradian, may be found from the equation  $I_e = I_v/\eta_v$ , where  $I_v$  is the luminous intensity in candelas and  $\eta_v$  is the luminous efficacy in lumens/watt.

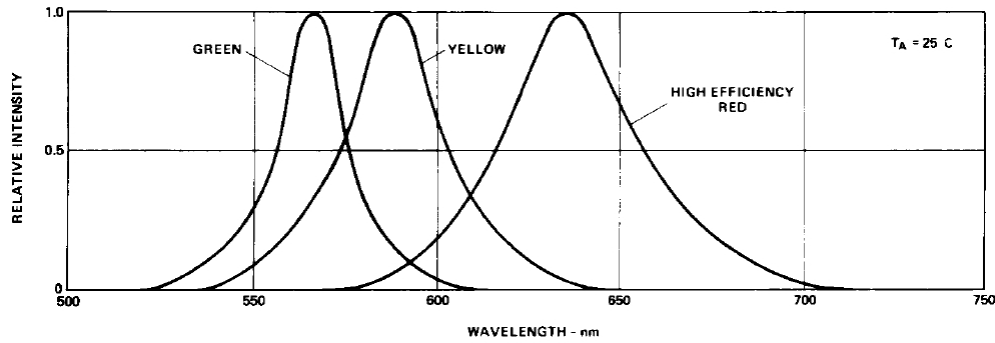

Figure 1. Relative intensity vs. wavelength.

### T-1 High Efficiency Red Non-Diffused

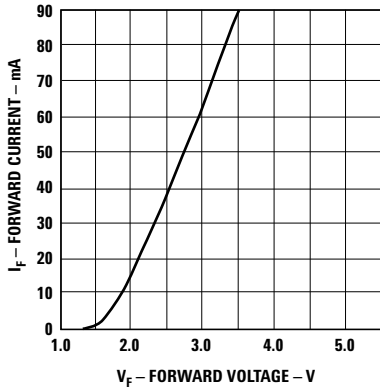

Figure 2. Forward current vs. forward voltage characteristics.

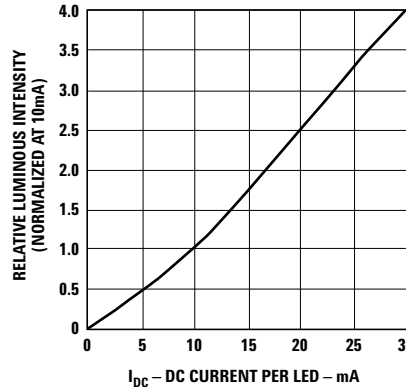

Figure 3. Relative luminous intensity vs. DC forward current.

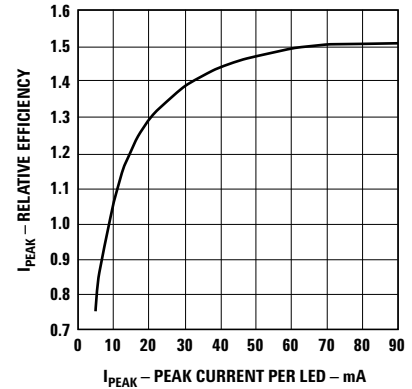

Figure 4. Relative efficiency (luminous intensity per unit current) vs. peak LED current.

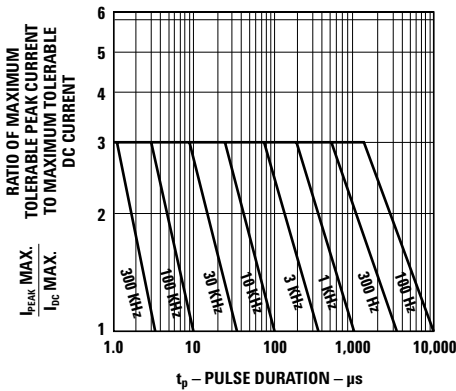

Figure 5. Maximum tolerable peak current vs. pulse duration. ( $I_{DC}$  MAX as per MAX ratings).

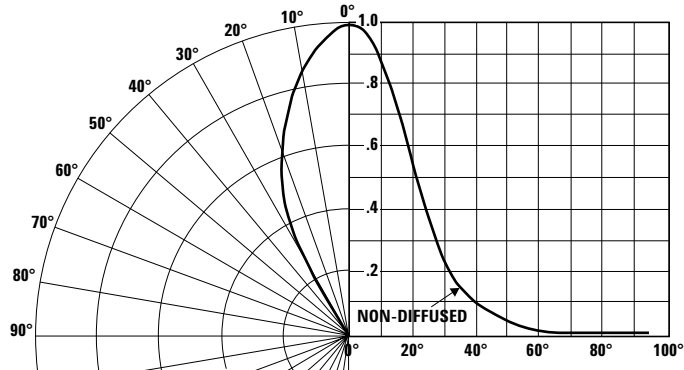

Figure 6. Relative luminous intensity vs. angular displacement.

## T-1 Yellow Non-Diffused

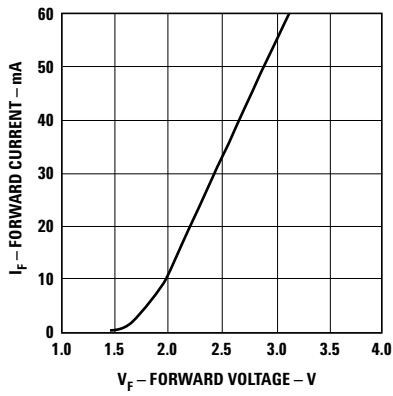

Figure 7. Forward current vs. forward voltage characteristics.

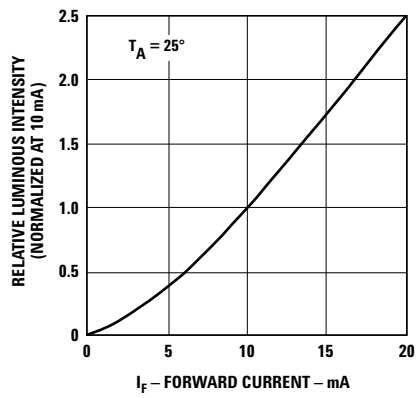

Figure 8. Relative luminous intensity vs. forward current.

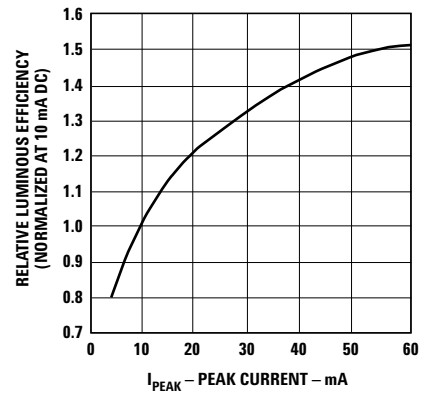

Figure 9. Relative efficiency (luminous intensity per unit current) vs. peak current.

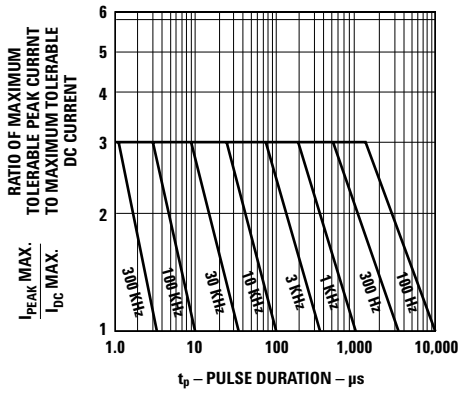

Figure 10. Maximum tolerable peak current vs. pulse duration. ( $I_{DC}$  MAX as per MAX ratings).

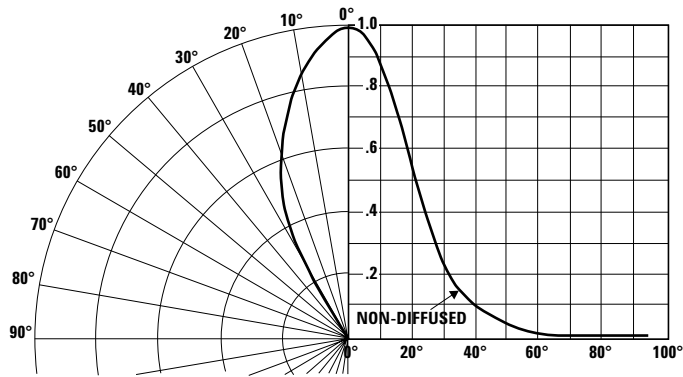

Figure 11. Relative luminous intensity vs. angular displacement.

# T-1 Green Non-Diffused

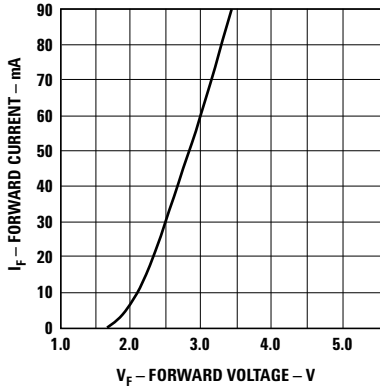

Figure 12. Forward current vs. forward voltage characteristics.

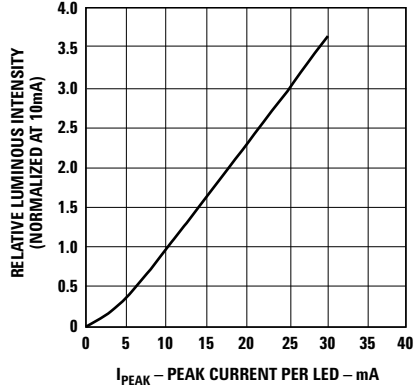

Figure 13. Relative luminous intensity vs. forward current.

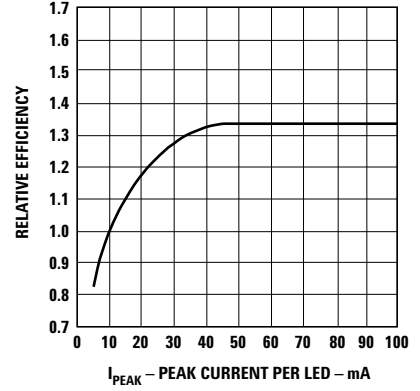

Figure 14. Relative efficiency (luminous intensity per unit current) vs. peak LED current.

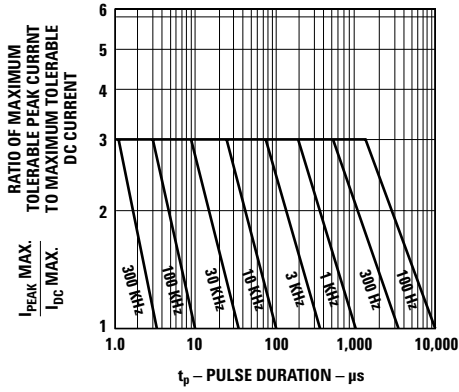

Figure 15. Maximum tolerable peak current vs. pulse duration. ( $I_{DCMAX}$  as per MAX ratings).

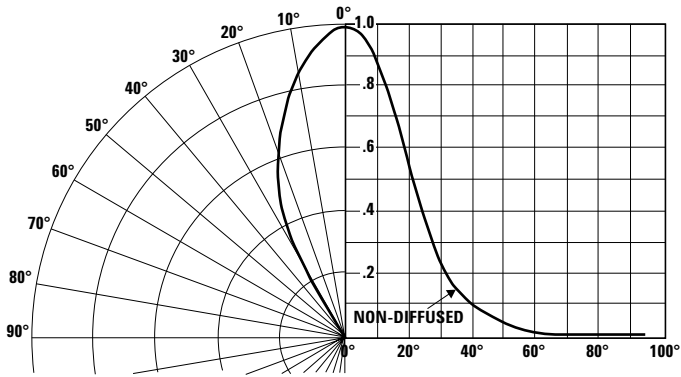

Figure 16. Relative luminous intensity vs. angular displacement.

### Intensity Bin Limits

Color	Bin	Intensity Range (mcd)	
		Min.	Max.
Red	G	9.7	15.5
	H	15.5	24.8
	I	24.8	39.6
	J	39.6	63.4
	K	63.4	101.5
	L	101.5	162.4
	M	162.4	234.6
	N	234.6	340.0
	O	340.0	540.0
	P	540.0	850.0
	Q	850.0	1200.0
	R	1200.0	1700.0
	S	1700.0	2400.0
	T	2400.0	3400.0
	U	3400.0	4900.0
	V	4900.0	7100.0
	W	7100.0	10200.0
	X	10200.0	14800.0
	Y	14800.0	21400.0
	Z	21400.0	30900.0
Yellow	F	10.3	16.6
	G	16.6	26.5
	H	26.5	42.3
	I	42.3	67.7
	J	67.7	108.2
	K	108.2	173.2
	L	173.2	250.0
	M	250.0	360.0
	N	360.0	510.0
	O	510.0	800.0
	P	800.0	1250.0
	Q	1250.0	1800.0
	R	1800.0	2900.0
	S	2900.0	4700.0
	T	4700.0	7200.0
	U	7200.0	11700.0
	V	11700.0	18000.0
W	18000.0	27000.0	

### Intensity Bin Limits

Color	Bin	Intensity Range (mcd)	
		Min.	Max.
Green	E	7.6	12.0
	F	12.0	19.1
	G	19.1	30.7
	H	30.7	49.1
	I	49.1	78.5
	J	78.5	125.7
	K	125.7	201.1
	L	201.1	289.0
	M	289.0	417.0
	N	417.0	680.0
	O	680.0	1100.0
	P	1100.0	1800.0
	Q	1800.0	2700.0
	R	2700.0	4300.0
	S	4300.0	6800.0
	T	6800.0	10800.0
	U	10800.0	16000.0
V	16000.0	25000.0	
W	25000.0	40000.0	

Maximum tolerance for each bin limit is  $\pm 18\%$ .

## Color Categories

Color	Category #	Lambda (nm)	
		Min.	Max.
Green	6	561.5	564.5
	5	564.5	567.5
	4	567.5	570.5
	3	570.5	573.5
	2	573.5	576.5
Yellow	1	582.0	584.5
	3	584.5	587.0
	2	587.0	589.5
	4	589.5	592.0
	5	592.0	593.0

Maximum tolerance for each bin limit is  $\pm 0.5$  nm.

## Mechanical Option Matrix

Mechanical Option Code	Definition
00	Bulk Packaging, minimum increment 500 pcs/bag
01	Tape & Reel, crimped leads, minimum increment 1800 pcs/bag
02	Tape & Reel, straight leads, minimum increment 1800 pcs/bag
A1	Right Angle Housing, uneven leads, minimum increment 500 pcs/bag
A2	Right Angle Housing, even leads, minimum increment 500 pcs/bag

**Note:**

All categories are established for classification of products. Products may not be available in all categories. Please contact your local Avago representative for further clarification/information.



## Precautions:

### Lead Forming

- The leads of an LED lamp may be preformed or cut to length prior to insertion and soldering into PC board.
- If lead forming is required before soldering, care must be taken to avoid any excessive mechanical stress induced to LED package. Otherwise, cut the leads of LED to length after soldering process at room temperature. The solder joint formed will absorb the mechanical stress of the lead cutting from traveling to the LED chip die attach and wirebond.
- It is recommended that tooling made to precisely form and cut the leads to length rather than rely upon hand operation.

### Soldering Conditions

- Care must be taken during PCB assembly and soldering process to prevent damage to LED component.
- The closest LED is allowed to solder on board is 1.59 mm below the body (encapsulant epoxy) for those parts without standoff.
- Recommended soldering conditions:

	Wave Soldering	Manual Solder Dipping
Pre-heat Temperature	105°C Max.	–
Pre-heat Time	30 sec Max.	–
Peak Temperature	250°C Max.	260°C Max.
Dwell Time	3 sec Max.	5 sec Max.

- Wave soldering parameter must be set and maintained according to recommended temperature and dwell time in the solder wave. Customer is advised to periodically check on the soldering profile to ensure the soldering profile used is always conforming to recommended soldering condition.
- If necessary, use fixture to hold the LED component in proper orientation with respect to the PCB during soldering process.
- Proper handling is imperative to avoid excessive thermal stresses to LED components when heated. Therefore, the soldered PCB must be allowed to cool to room temperature, 25°C, before handling.
- Special attention must be given to board fabrication, solder masking, surface plating and lead holes size and component orientation to assure solderability.
- Recommended PC board plated through hole sizes for LED component leads:

LED Component Lead Size	Diagonal	Plated Through Hole Diameter
0.457 x 0.457 mm (0.018 x 0.018 inch)	0.646 mm (0.025 inch)	0.976 to 1.078 mm (0.038 to 0.042 inch)
0.508 x 0.508 mm (0.020 x 0.020 inch)	0.718 mm (0.028 inch)	1.049 to 1.150 mm (0.041 to 0.045 inch)

**Note:** Refer to application note AN1027 for more information on soldering LED components.

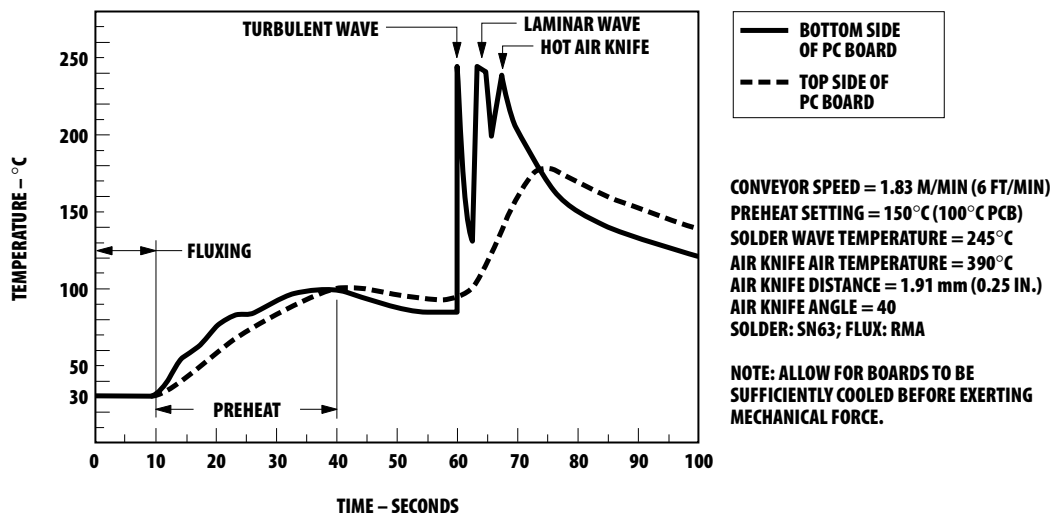

Figure 17. Recommended wave soldering profile.

For product information and a complete list of distributors, please go to our website: [www.avagotech.com](http://www.avagotech.com)

Компания «Океан Электроники» предлагает заключение долгосрочных отношений при поставках импортных электронных компонентов на взаимовыгодных условиях!

Наши преимущества:

- Поставка оригинальных импортных электронных компонентов напрямую с производств Америки, Европы и Азии, а так же с крупнейших складов мира;
- Широкая линейка поставок активных и пассивных импортных электронных компонентов (более 30 млн. наименований);
- Поставка сложных, дефицитных, либо снятых с производства позиций;
- Оперативные сроки поставки под заказ (от 5 рабочих дней);
- Экспресс доставка в любую точку России;
- Помощь Конструкторского Отдела и консультации квалифицированных инженеров;
- Техническая поддержка проекта, помощь в подборе аналогов, поставка прототипов;
- Поставка электронных компонентов под контролем ВП;
- Система менеджмента качества сертифицирована по Международному стандарту ISO 9001;
- При необходимости вся продукция военного и аэрокосмического назначения проходит испытания и сертификацию в лаборатории (по согласованию с заказчиком);
- Поставка специализированных компонентов военного и аэрокосмического уровня качества (Xilinx, Altera, Analog Devices, Intersil, Interpoint, Microsemi, Actel, Aeroflex, Peregrine, VPT, Syfer, Eurofarad, Texas Instruments, MS Kennedy, Miteq, Cobham, E2V, MA-COM, Hittite, Mini-Circuits, General Dynamics и др.);

Компания «Океан Электроники» является официальным дистрибьютором и эксклюзивным представителем в России одного из крупнейших производителей разъемов военного и аэрокосмического назначения «JONHON», а так же официальным дистрибьютором и эксклюзивным представителем в России производителя высокотехнологичных и надежных решений для передачи СВЧ сигналов «FORSTAR».



## JONHON

«JONHON» (основан в 1970 г.)

Разъемы специального, военного и аэрокосмического назначения:

(Применяются в военной, авиационной, аэрокосмической, морской, железнодорожной, горно- и нефтедобывающей отраслях промышленности)

«FORSTAR» (основан в 1998 г.)

ВЧ соединители, коаксиальные кабели,  
кабельные сборки и микроволновые компоненты:

(Применяются в телекоммуникациях гражданского и специального назначения, в средствах связи, РЛС, а так же военной, авиационной и аэрокосмической отраслях промышленности).



Телефон: 8 (812) 309-75-97 (многоканальный)

Факс: 8 (812) 320-03-32

Электронная почта: [ocean@oceanchips.ru](mailto:ocean@oceanchips.ru)

Web: <http://oceanchips.ru/>

Адрес: 198099, г. Санкт-Петербург, ул. Калинина, д. 2, корп. 4, лит. А