

Features

- 3535 UV LED
- ROHS and REACH Compliant
- MSL 3 qualified according to J-STD 020
- ESD 8KV

Applications

- UV Curing
- Medical applications
- Counterfeit Detection
- Purification

Description

The IN-C33(X)TN UV series is a high-power UV LED. It is a SMD type LED which can be used in various applications.



Recommended Solder Pattern

(Suggest Stencil $t=0.12$ mm)

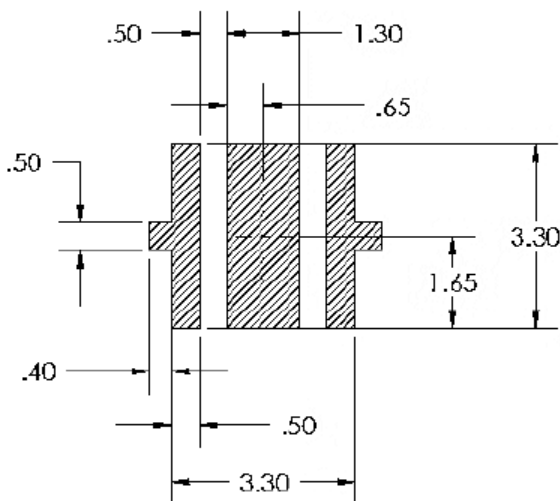

Recommended PCB Solder PAD
(Suggest Stencil $t=0.12$ mm)

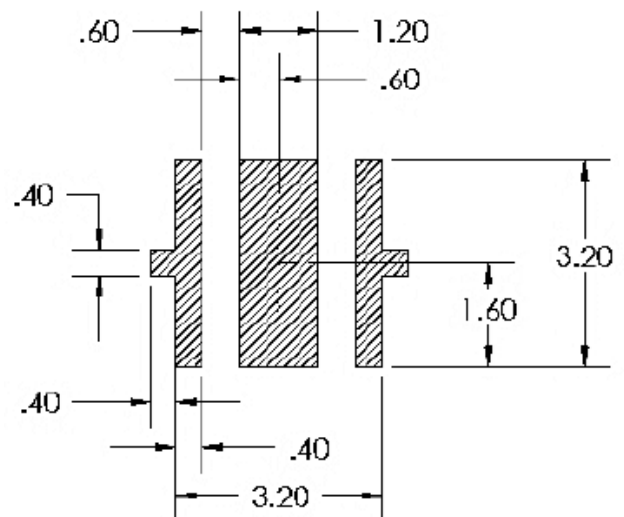

Recommended Stencil Pattern (Hatched Area is Opening)

Figure 1. IN-C33ATN / IN-C33BTN / IN-C33CTN Recommended Solder Pattern

Note:

- * All dimensions are in millimeters.
- * Tolerance is ± 0.13 mm unless other specified.

Package Dimensions

Figure 2. IN-C33ATN / IN-C33BTN / IN-C33CTN Package Dimension
Note:

All dimensions are in millimeters.

Tolerance is $\pm 0.13\text{mm}$ unless other specified.

Absolute Maximum Rating at 25°C

Characteristics	Symbol	Min.	Typical	Max.	Unit
DC Forward Current ¹	I _F		500	1000	mA
Pulse Current (@1/10 duty) ²	I _P			1500	mA
Forward Voltage	V _F	3.2		3.8	V
Reverse Voltage	V _R			-5	V
Leakage Current (5V)	I _R			10	μA
Junction Temperature ³	T _j		150		°C
Operating Temperature Range	T _{opr}	-40	-	125	°C
Storage Temperature Range	T _{stg}	-40	-	125	°C
Soldering Temperature	T _{sol}			260	°C
Thermal Resistance Junction / Solder Point	R _{th}		4.5		°C/W
Viewing Angle ⁴	2θ _{1/2}		30/60/120		Deg

Notes:

1. When operating at other than ambient temperature, maximum allowable current depends on derating curves.
2. Pulse width = 0.01s & duty factor = 1/10.
3. When operating at maximum allowable current, T_j must be below 150 °C.
4. Viewing angle tolerance is ± 10°.

Electrical Characteristics T_A = 25°C (Note 1)

Product	V _F (V)@500mA			Viewing Angle	I _R (μA)@V _R =5V
	min	typ	max	2 θ 1/2	max
IN-C33ATN UV Series IN-C33BTN UV Series IN-C33CTN UV Series	3.2	---	3.8	30/60/120	10

Notes:

1. Performance guaranteed only under conditions listed in above tables.

ESD Precaution

ATTENTION: Electrostatic Discharge (ESD) protection



The symbol above denotes that ESD precaution is needed. ESD protection for GaP and AlGaAs based chips is necessary even though they are relatively safe in the presence of low static-electric discharge. Parts built with AlInGaP, GaN, or/and InGaN based chips are STATIC SENSITIVE devices. ESD precaution must be taken during design and assembly. If manual work or processing is needed, please ensure the device is adequately protected from ESD during the process.

Please be advised that normal static precautions should be taken in the handling and assembly of this device to prevent damage or degradation which may be induced by electrostatic discharge (ESD).

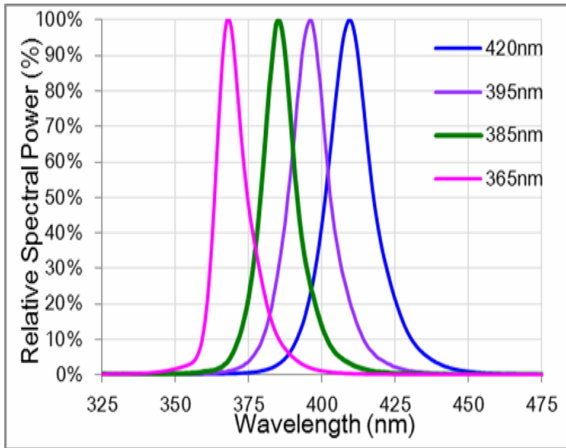
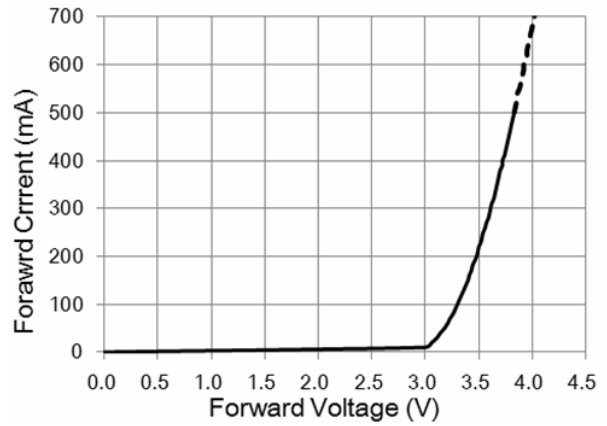
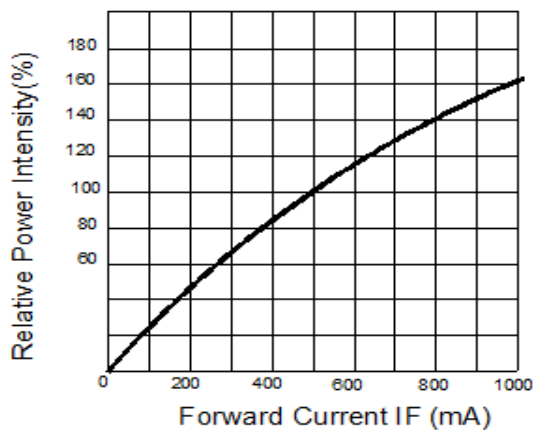
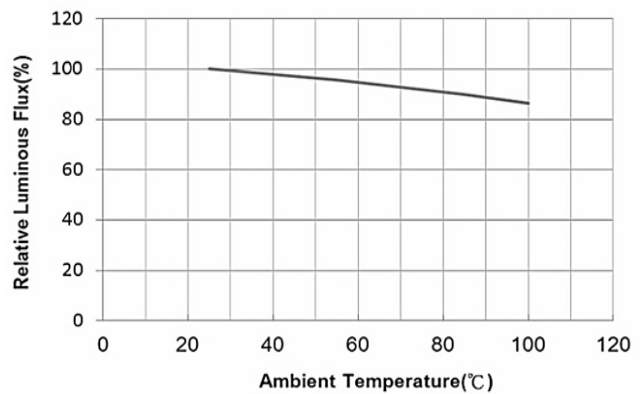
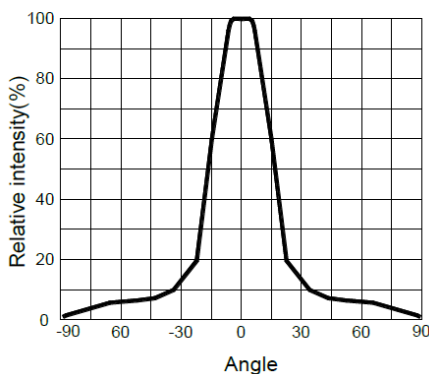
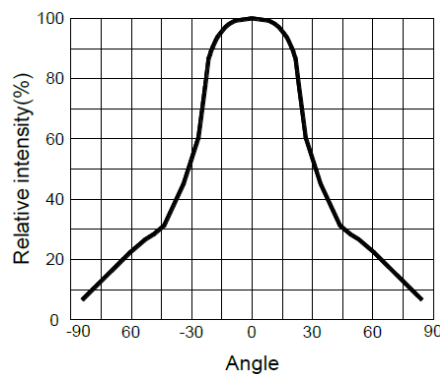
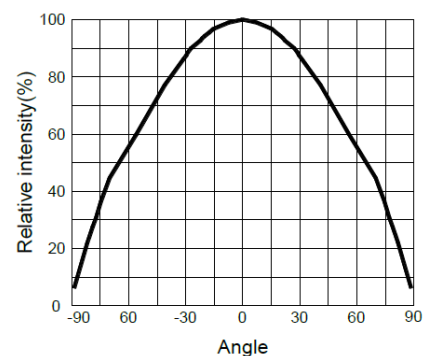
Electronic-Optical Characteristics
Relative Spectral Power Distribution

Forward Current vs. Forward Voltage (Ta=25°C)

Relative Radiant Flux vs. Forward Current (Ta=25°C)

Relative Radiant Flux vs. Ambient Temperature (IF=500mA)

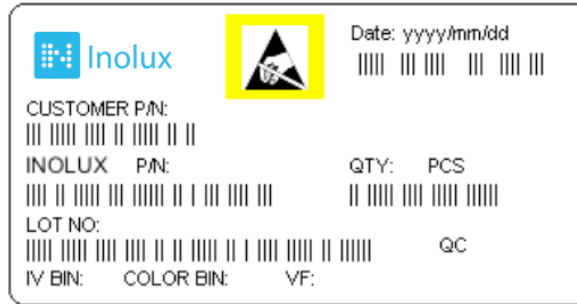
Beam angle (2θ1/2)
Beam Angle 30D

Beam Angle 60D

Beam Angle 120D

Notes:

Viewing angle(2θ1/2) ± 10°

Ordering Information

Product	Emission Color	Viewing Angle	Orderable Part Number
IN-C33(X)TN	U2:365~370nm	30°	IN-C33ATNU2
		60°	IN-C33BTNU2
		120°	IN-C33CTNU2
	U4:380~390nm	30°	IN-C33ATNU4
		60°	IN-C33BTNU4
		120°	IN-C33CTNU4
	U5:390~400nm	30°	IN-C33ATNU5
		60°	IN-C33BTNU5
		120°	IN-C33CTNU5

Label Specifications

Inolux P/N:

I	N	-	C	3	3	X	T	N		X	-	X	X	X	X
Inolux SMD			Material	Package	Variation	Orientation	Current	Lens	Color			Customized Stamp-off			
			C = Ceramic Type	33A = 3.5 x 3.5 30 Deg. 33B = 3.5 x 3.5, 60 Deg. 33C = 3.5 x 3.5, 120 Deg.		T = Top Mount	N = 500mA	(Blank) = Clear	U5 = 390-400nm U4 = 380-390nm U2 = 365-370nm						

Lot No.:

Z	2	0	1	7	01	24	001
Internal Tracker	Year (2017, 2018,)				Month	Date	Serial

Peak Wavelength Binning

Peak Wavelength unit: nm@500mA			
Bin Code		Min	Max
U2	R1	365.0	367.5
	R2	365.5	370.0
U4	S1	380.0	382.5
	S2	382.5	385.0
	S3	385.0	387.5
	S4	387.5	390.0
U5	T1	390.0	392.5
	T2	392.5	395.0
	T3	395.0	397.5
	T4	397.5	400.0

Notes:

1. Binning current is 500mA
2. Wavelength tolerance ± 2 nm

Voltage Binning

Peak Wavelength	Voltage unit: V@500mA		
	Bin Code	Min	Max
U2:365~370nm	V1	3.2	3.3
	V2	3.3	3.4
	V3	3.4	3.5
	V4	3.5	3.6
	V5	3.6	3.7
	V6	3.7	3.8
U4:380~390nm	V1	3.2	3.3
	V2	3.3	3.4
	V3	3.4	3.5
	V4	3.5	3.6
	V5	3.6	3.7
U5:390~400nm	V1	3.2	3.3
	V2	3.3	3.4
	V3	3.4	3.5
	V4	3.5	3.6
	V5	3.6	3.7
	V6	3.7	3.8

Notes:

1. Binning current is 500mA
2. Voltage tolerance ± 0.06 nm

Radiant flux (Power) binning

Peak Wavelength	Radiant flux (Power) unit: mw@500mA			Radiant flux (Power) unit: mw@700mA		
	Bin Code	Min	Max	Bin Code	Min	Max
U2:365~370nm	B2	700	740	B2	910	962
	B3	740	780	B3	962	1014
	B4	780	820	B4	1014	1066
	B5	820	860	B5	1066	1118
	B6	860	900	B6	1118	1170
U4:380~390nm	B8	1000	1080	B8	1300	1404
	B9	1080	1160	B9	1404	1508
	B10	1160	1240	B10	1508	1612
	B11	1240	1320	B11	1612	1716
	B12	1320	1400	B12	1716	1820
U5:390~400nm	B8	1000	1080	B8	1300	1404
	B9	1080	1160	B9	1404	1508
	B10	1160	1240	B10	1508	1612
	B11	1240	1320	B11	1612	1716
	B12	1320	1400	B12	1716	1820

Notes:

1. Binning current is 500mA
2. Power tolerance \pm 50mw

Thermal Design

Thermal design of the end product is important. The thermal resistance between the junction and the solder point (R_{θJ-S}) and the end product should be designed to minimize the thermal resistance from the solder point to ambient in order to optimize the emitter life and optical characteristics. The maximum operation current is determined by the plot of Allowable Forward Current vs. Ambient Temperature.



The junction temperature can be correlated to the thermal resistance between the junction and ambient (R_{ja}) by the following equation.

$$T_j = T_a + R_{ja} * W$$

T_j = LED junction temperature

T_a = Ambient temperature

R_{ja} = Thermal resistance between the junction and ambient

W = Input power (I_F*V_F)

Reflow Soldering

The LEDs can be soldered using the parameter listed below. As a general guideline, the users are suggested to follow the recommended soldering profile provided by the manufacturer of the solder paste. Although the recommended soldering conditions are specified in the list, reflow soldering at the lowest possible temperature is preferred for the LEDs.

Suggested lead-free soldering profile:



Notes:

1. The recommended reflow temperature is 240°C(±5°C). The maximum soldering temperature should be limited to 260°C.
2. Do not stress the silicone resin while it is exposed to high temperature.
3. The number of reflow process should not exceed 3 times.

Packing

The carrier tape conforms to EIA-481D.



1. 10 sprocket hole pitch cumulative tolerance ± 0.20 .
2. Carrier camber is within 1 mm in 250 mm.
3. Material: Black Conductive Polystyrene Alloy.
4. All dimensions meet EIA-481-D requirements.
5. Thickness: 0.30 ± 0.05 mm
6. Packing length per 22" reel: 62.5 Meters (1:3).
7. Component load per 7" reel: 400~1000 pcs.

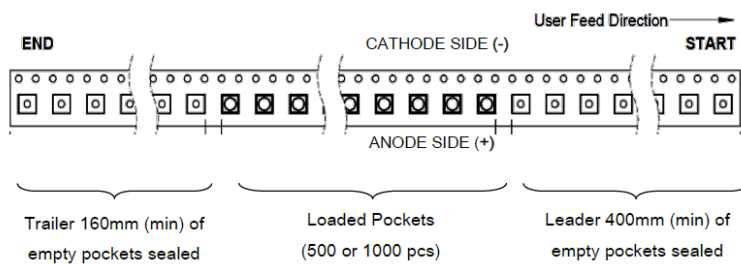

Notes:

1. Each Reel (minimum number of pieces is 100 and maximum is 500 (60D)/1000 (120D)) packed in a moisture-proof bag along with 2 packs of desiccant and a humidity indicator card.
2. A maximum of 5 moisture-proof bags are packed in an inner box (size: 240mm x 200mm x 105mm \pm 5mm).
3. A maximum of 4 inner boxes are put in an outer box (size: 410mm x 255mm x 230mm \pm 5mm).
4. Part No., Lot No., quantity should be indicated on the label of the moisture-proof bag and the cardboard box.

Precautions

1. Recommendation for using LEDs

1.1 The lens of LEDs should not be exposed to dust or debris. Excessive dust and debris may cause a drastic decrease in the luminosity.

1.2 Avoid mechanical stress on LED lens.

1.3 Do not touch the LED lens surface. It would affect the optical performance of the LED due to the LED lens' damage.

1.4 Pick & place tools are recommended for the remove of LEDs from the factory tape & reel packaging.

2. Pick & place nozzle

The pickup tool was recommended and shown as below:

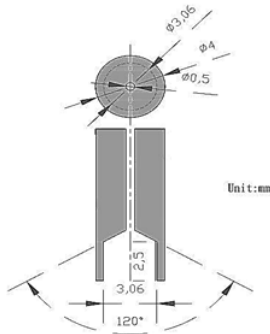

3. Lens handling

Please follow the guideline to pick LEDs:

3.1 Use tweezers to pick LEDs.

3.2 Do not touch the lens by using tweezers.

3.3 Do not touch lens with fingers.

3.4 Do not apply more than 4N of force (400g) directly onto the lens.

4. Lens cleaning

In the case which a small amount of dirt and dust particles remain on the lens surface, a suitable cleaning solution can be applied.

4.1 Try gently wiping with a dust-free cloth.

4.2 If needed, use a dust-free cloth and isopropyl alcohol to gently remove the dirt from the lens surface.

4.3 Do not use other solvents as they may react with the LED assembly.

4.4 Do not use ultrasonic cleaning which will damage the LEDs.

Test Items and Results of Reliability

Test Item	Test Conditions	Duration/ Cycle	Number of Damage	Reference
Thermal Shock	-40°C 30min ↑↓5min 125 °C 30min	100 cycles	0/22	AECQ101
High Temperature Storage	Ta=100°C	1000 hrs	0/22	EIAJ ED-4701 200 201
Humidity Heat Storage	Ta=85°C RH=85%	1000 hrs	0/22	EIAJ ED-4701 100 103
Low Temperature Storage	Ta=-40°C	1000 hrs	0/22	EIAJ ED-4701 200 202
Life Test	Ta=25°C If=500mA	1000 hrs	0/22	Tested with IN standard
High Humidity Heat Life Test	85°C RH=85% If=500mA	1000 hrs	0/22	Tested with IN standard
High Temperature Life Test	Ta=85°C	1000 hrs	0/22	Tested with IN standard
ESD(HBM)	8KV at 1.5kΩ;100pf	3 Times	0/22	MIL-STD-883

Criteria for Judging the Damage				
Item	Symbol	Condition	Criteria for Judgment	
			Min	Max
Forward Voltage	VF	If=500mA	LSL ×0.9	USL ×1.1
Reverse Current	IR	VR =5V	-	100μA
Luminous Intensity	Iv	If=500mA	LSL ×0.7	USL ×1.2

Notes:

1. USL: Upper specification level
2. LSL: Lower specification level

Revision History

Changes since last revision	Page	Version No.	Revision Date
Initial Release		1.0	01-30-2018
Format Update		1.1	09-04-2018

DISCLAIMER

INOLUX reserves the right to make changes without further notice to any products herein to improve reliability, function or design. INOLUX does not assume any liability arising out of the application or use of any product or circuit described herein; neither does it convey any license under its patent rights, nor the rights of others.

LIFE SUPPORT POLICY

INOLUX's products are not authorized for use as critical components in life support devices or systems without the express written approval of the President of INOLUX or INOLUX CORPORATION. As used herein:

1. Life support devices or systems are devices or systems which, (a) are intended for surgical implant into the body, or (b) support or sustain life, and (c) whose failure to perform when properly used in accordance with instructions for use provided in the labeling, can be reasonably expected to result in a significant injury of the user.
2. A critical component in any component of a life support device or system whose failure to perform can be reasonably expected to cause the failure of the life support device or system, or to affect its safety or effectiveness.

Компания «Океан Электроники» предлагает заключение долгосрочных отношений при поставках импортных электронных компонентов на взаимовыгодных условиях!

Наши преимущества:

- Поставка оригинальных импортных электронных компонентов напрямую с производств Америки, Европы и Азии, а так же с крупнейших складов мира;
- Широкая линейка поставок активных и пассивных импортных электронных компонентов (более 30 млн. наименований);
- Поставка сложных, дефицитных, либо снятых с производства позиций;
- Оперативные сроки поставки под заказ (от 5 рабочих дней);
- Экспресс доставка в любую точку России;
- Помощь Конструкторского Отдела и консультации квалифицированных инженеров;
- Техническая поддержка проекта, помощь в подборе аналогов, поставка прототипов;
- Поставка электронных компонентов под контролем ВП;
- Система менеджмента качества сертифицирована по Международному стандарту ISO 9001;
- При необходимости вся продукция военного и аэрокосмического назначения проходит испытания и сертификацию в лаборатории (по согласованию с заказчиком);
- Поставка специализированных компонентов военного и аэрокосмического уровня качества (Xilinx, Altera, Analog Devices, Intersil, Interpoint, Microsemi, Actel, Aeroflex, Peregrine, VPT, Syfer, Eurofarad, Texas Instruments, MS Kennedy, Miteq, Cobham, E2V, MA-COM, Hittite, Mini-Circuits, General Dynamics и др.);

Компания «Океан Электроники» является официальным дистрибьютором и эксклюзивным представителем в России одного из крупнейших производителей разъемов военного и аэрокосмического назначения «JONHON», а так же официальным дистрибьютором и эксклюзивным представителем в России производителя высокотехнологичных и надежных решений для передачи СВЧ сигналов «FORSTAR».



JONHON

«JONHON» (основан в 1970 г.)

Разъемы специального, военного и аэрокосмического назначения:

(Применяются в военной, авиационной, аэрокосмической, морской, железнодорожной, горно- и нефтедобывающей отраслях промышленности)

«FORSTAR» (основан в 1998 г.)

ВЧ соединители, коаксиальные кабели, кабельные сборки и микроволновые компоненты:

(Применяются в телекоммуникациях гражданского и специального назначения, в средствах связи, РЛС, а так же военной, авиационной и аэрокосмической отраслях промышленности).



Телефон: 8 (812) 309-75-97 (многоканальный)

Факс: 8 (812) 320-03-32

Электронная почта: ocean@oceanchips.ru

Web: <http://oceanchips.ru/>

Адрес: 198099, г. Санкт-Петербург, ул. Калинина, д. 2, корп. 4, лит. А