

### GENERAL DESCRIPTION

This document describes specifications for the F1650NLGI Zero/Complex IF Modulator implementing Zero-Distortion™ technology for low power consumption with improved ACLR. This device interfaces directly to a high performance Tx dual DAC.

### COMPETITIVE ADVANTAGE

In typical multi-mode, multi-carrier basestation transmitters the modulator has limited linearity and high power consumption which penalizes the system ACLR and system Power consumptions budgets in a Digital-Pre-Distortion environment.

The IDTF1650 is designed to eliminate these penalties by embedding Zero-Distortion™ technology into the device such that very high IP3 and IP2 are achieved with minimal current draw.

- Power consumption ↓**45%**
- IM3 Distortion ↓**12 dB**



### PART# MATRIX

Part#	RF freq Range	IP2 <sub>o</sub>	Power Cons.	IP3 <sub>o</sub>	Noise
F1650	600 – 2400	+60 dBm	587 mW	+36 dBm	-158 dBm/Hz

### FEATURES

- Power Gain = 3.25dB
- Direct 100Ω differential drive from Tx DAC
- **< 590mW Power Consumption @ 2GHz**
- -158dBm/Hz Output Noise
- IP2<sub>o</sub> = +60dBm @ 2GHz
- **IP3<sub>o</sub> = +36dBm @ 2GHz**
- Excellent native LO and image suppression
- 600 MHz input 1dB Bandwidth
- 600 MHz to 2400MHz RF BW
- **Constant LO impedance when OFF**
- 3.3V Single Power Supply
- LO port can be driven single ended or differential
- 4mm x 4mm 24-pin TQFN package

### DEVICE BLOCK DIAGRAM

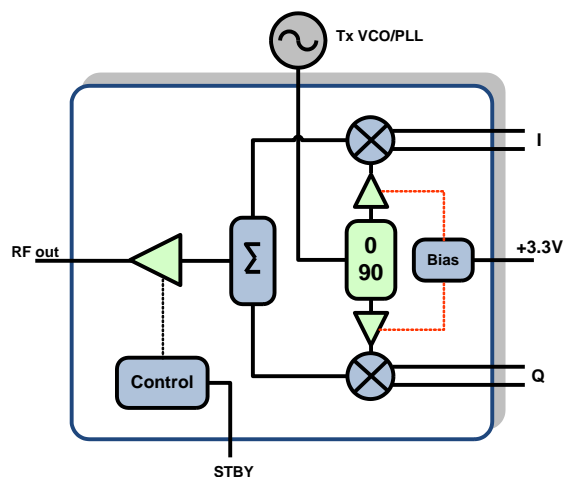

### ORDERING INFORMATION

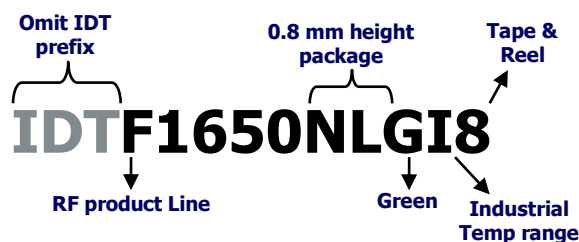



**ABSOLUTE MAXIMUM RATINGS**

VDD to GND	-0.3V to +3.6V
STBY	-0.3V to (VDD + 0.3V)
BB_I+, BB_I-, BB_Q+, BB_Q-	-0.3V to 1.8V
LO_IN	-0.3V to 0.3V
RF_OUT	(VDD-0.35V) to (VDD-0.05V)
Continuous Power Dissipation	1.5W
$\theta_{JA}$ (Junction – Ambient)	+45°C/W
$\theta_{JC}$ (Junction – Case) The Case is defined as the exposed paddle	+2.5°C/W
Operating Temperature Range (Case Temperature)	$T_{CASE} = -40^{\circ}\text{C}$ to $+105^{\circ}\text{C}$
Maximum Junction Temperature	150°C
Storage Temperature Range	-65°C to +150°C
Lead Temperature (soldering, 10s)	+260°C

*Stresses above those listed above may cause permanent damage to the device. Functional operation of the device at these or any other conditions above those indicated in the operational section of this specification is not implied. Exposure to absolute maximum rating conditions for extended periods may affect device reliability*



**IDTF1650 RECOMMENDED OPERATION CONDITIONS**

Parameter	Comment	Symbol	min	typ	max	units
Supply Voltage(s)	All $V_{DD}$ pins	$V_{DD}$	3.15	<b>3.30</b>	3.45	V
Operating Temperature	Case Temperature	$T_{CASE}$	-40	<b>25</b>	+105	deg C
LO Freq Range	LO power -3dBm to +5dBm	$F_{LO}$	600		2400	MHz
BB Freq Range	<ul style="list-style-type: none"><li><math>F_{LO} = 1950</math> MHz, <math>BB_{IQ} = 200</math> mV</li><li><math>P_{RF}</math> degrades &lt; 1 dB</li></ul>	$F_{BB}$	DC		600	MHz

**IDTF1650 SPECIFICATION**

See application circuit. Typical values are measured at  $V_{DD} = +3.3V$ ,  $F_{LO} = 1950$  MHz,  $P_{LO} = 0$  dBm,  $T_{CASE} = +25^{\circ}C$ , STBY = GND, BB\_IQ frequency = 49, 50 MHz, BB\_I&Q levels = 200 mVp-p each (14 dB backoff from 1V DAC compliance), I & Q = 0.250V common-mode bias unless otherwise noted.

Parameter	Comment	Symbol	min	typ	max	units
Logic Input High	For STBY Pin	$V_{IH}$	<b>1.07</b>			V
Logic Input Low	For STBY Pin	$V_{IL}$			<b>0.68</b>	V
Logic Current	For STBY Pin	$I_{IH}, I_{IL}$	<b>-100</b>		<b>+1</b>	$\mu A$
Supply Current (ON)	Total $V_{DD}$	$I_{SUPP}$		<b>178</b>	<b>210<sup>1</sup></b>	mA
Supply Current (STBY)	Total $V_{DD}$ , STBY = $V_{IH}$	$I_{STBY}$		<b>6</b>	<b>15</b>	mA
LO Power	600MHz to 2400MHz	$P_{LO}$	-3		+5	dBm
BB Input Resistance (Differential)	Freq = 100 MHz	$R_{BB}$		113		$\Omega$
BB Common Mode Voltage	<ul style="list-style-type: none"> <li>DC couple to LCM DAC</li> <li><math>T_{CASE} = -40C</math> to <math>+105C</math></li> <li><math>V_{DD} = 3.3</math> V</li> <li>LO level = 0dBm</li> </ul>	$V_{CM}$	0.1	0.25	0.8	V
BB input voltage compliance range	For each BB pin		0		1	Vpeak
LO port Impedance	<ul style="list-style-type: none"> <li>Single Ended (RL &lt; -10dB)</li> <li>Can be driven differentially</li> </ul>	$Z_{LO}$		50		$\Omega$
RF port Impedance	Single Ended (RL < -10dB)	$Z_{RF}$		50		$\Omega$
Power Gain		G	<b>2.25</b>	<b>3.25</b>	<b>4.25</b>	dB
LO Path noise	<ul style="list-style-type: none"> <li>Calc. from Noise v. <math>P_{OUT}</math></li> <li>+ 10 MHz offset, 1.0 GHz <math>F_{LO}</math></li> </ul>	$\Phi_{N,LO}$		-157		dBc/Hz
Output IP3 @ 850 MHz	LO = 800 MHz	IP3 <sub>O1</sub>		35		dBm
Output IP3 @ 2.0 GHz	LO = 1950 MHz	IP3 <sub>O2</sub>	<b>30</b>	<b>36</b>		
Output IP3 @ 2.45 GHz	LO = 2400 MHz	IP3 <sub>O3</sub>		33		
Output IP2 @ 850 MHz	LO = 800 MHz	IP2 <sub>O1</sub>		63		dBm
Output IP2 @ 2.0 GHz	LO = 1950 MHz	IP2 <sub>O</sub>	55 <sup>2</sup>	60		
Output IP2 @ 2.45 GHz	LO = 2400 MHz	IP2 <sub>O3</sub>		60		
LO (Carrier) Suppression	Native, Uncorrected $F_{LO} = 1950$ MHz	LO <sub>supp</sub>		<b>-37</b>	<b>-30</b>	dBm
Sideband (Image) Suppression	Native, Uncorrected $F_{LO} = 1950$ MHz	SS		<b>-41</b>	<b>-30</b>	dBc
Output P1dB	Output Compression	P1dB <sub>O</sub>		15		dBm
Output Noise	<ul style="list-style-type: none"> <li>10 MHz offset from LO</li> <li>BB I&amp;Q levels = 0 V<sub>P-P</sub></li> </ul>	NSD	-157	-158		dBm/Hz

**SPECIFICATION NOTES:**

1 – Items in min/max columns in **bold italics** are Guaranteed by Test

2 – All other Items in min/max columns are Guaranteed by Design Characterization

**TYPICAL OPERATING CONDITIONS**

Unless otherwise noted, the following conditions apply:

- Baseband I&Q levels = 200 mV<sub>PP</sub> each (-13 dBm / Channel / Tone)
- Baseband I&Q tones = 49, 50 MHz
- Low Side Injection
- T<sub>AMB</sub> = 25C, V<sub>CC</sub> = 3.30 V, LO Power = 0 dBm where T<sub>AMB</sub> is the ambient temperature
- V<sub>CM</sub> = 0.250 Volts, where CM is common mode
- Flo = 1.95GHz unless otherwise specified, where lo is Local Oscillator
- EVKit RF output Trace and Connector Losses De-Embedded

**EVkit RF output loss (Trace + Connector)**

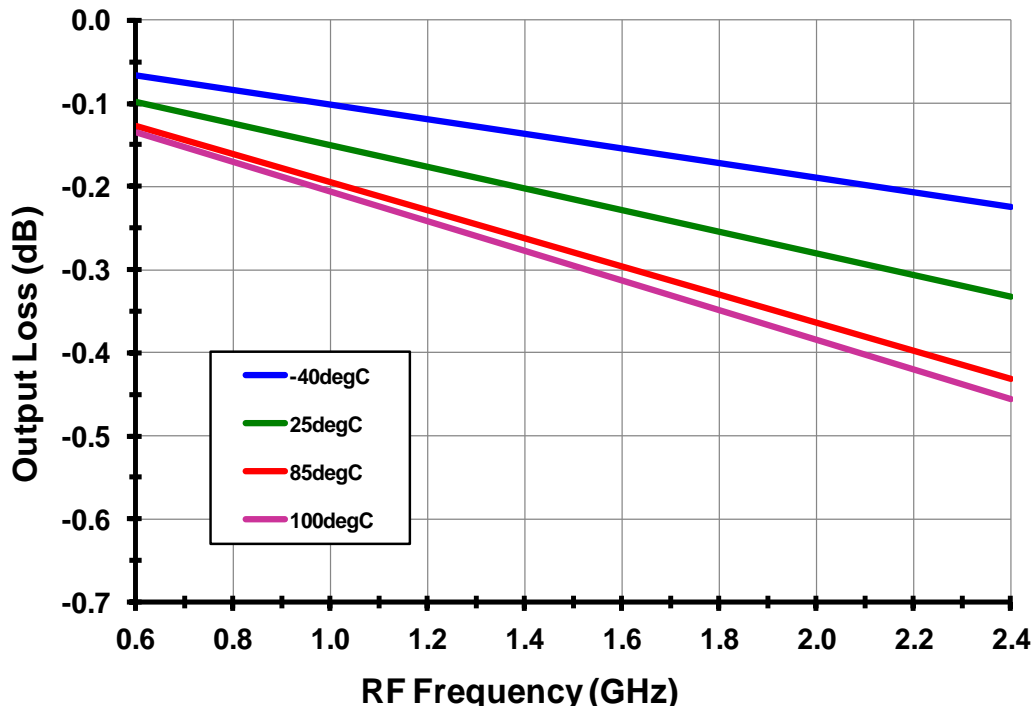

## TYPICAL OPERATING CURVES (-1-)

**OIP3 vs.  $T_{AMB}$**

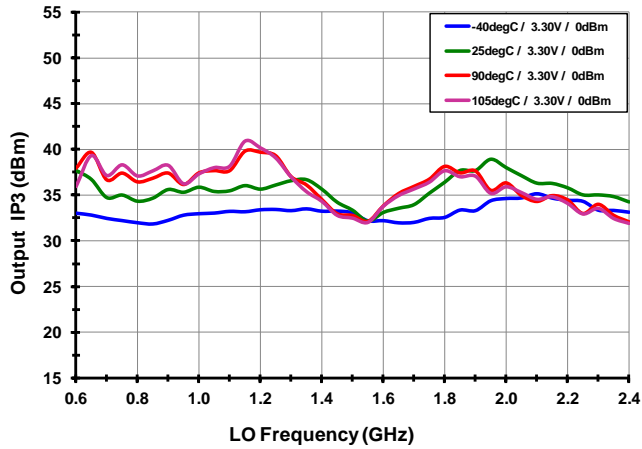

**OIP3 vs.  $V_{CC}$**

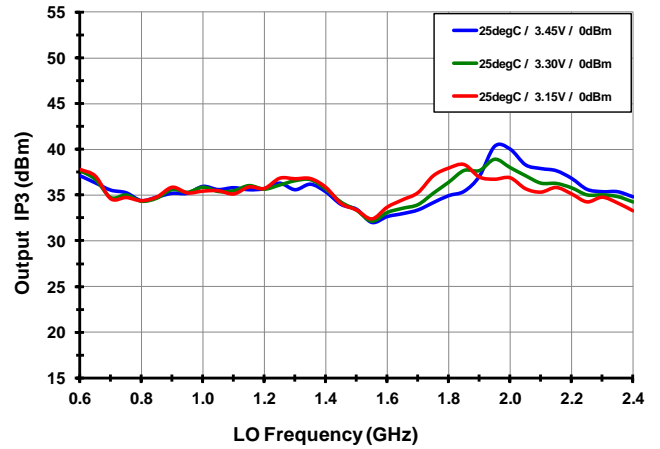

**OIP3 vs. LO level**

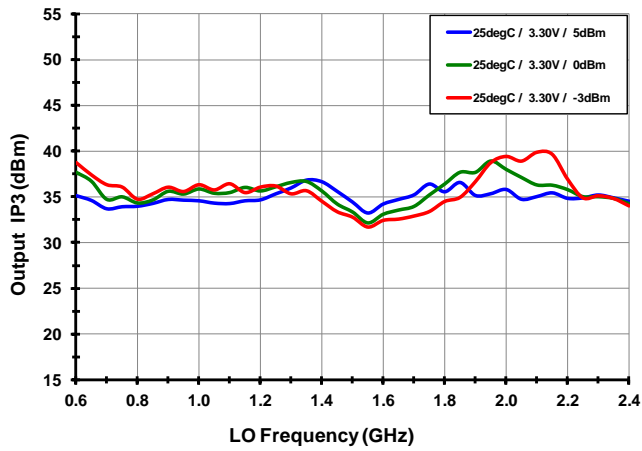

**OIP2 vs.  $T_{AMB}$**

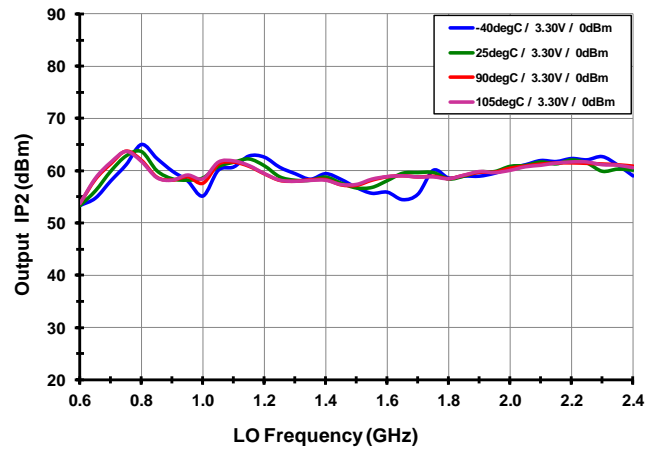

**OIP2 vs.  $V_{CC}$**

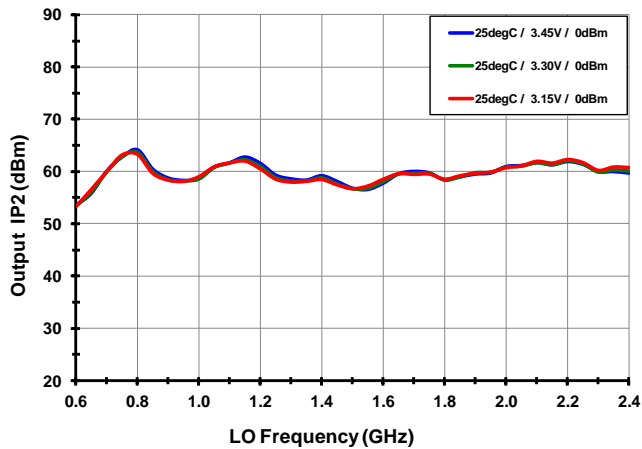

**OIP2 vs. LO level**

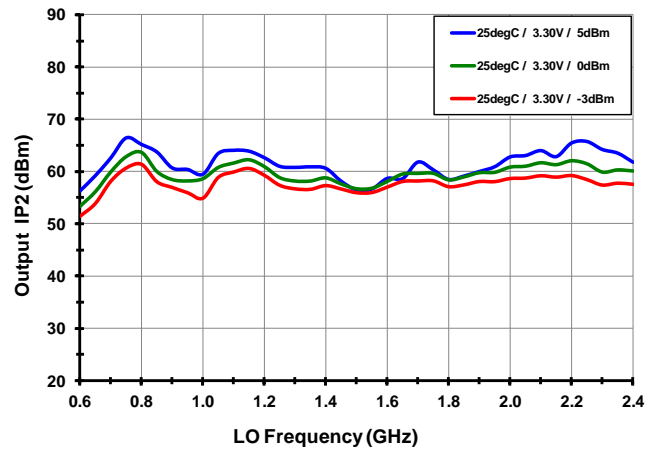

## TYPICAL OPERATING CURVES (-2-)

**I<sub>CC</sub> vs. T<sub>AMB</sub>**

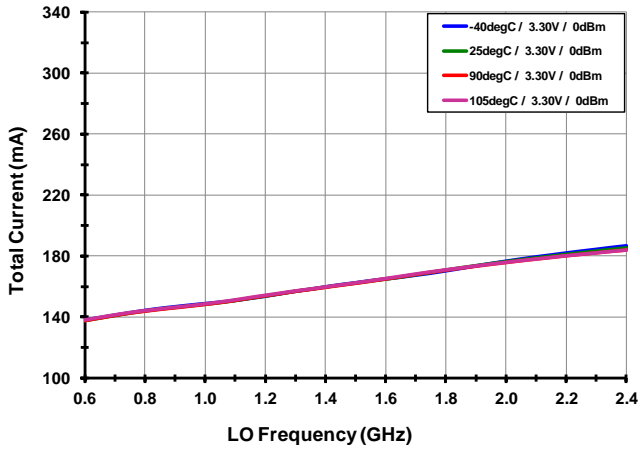

**I<sub>CC</sub> vs. V<sub>CC</sub>**

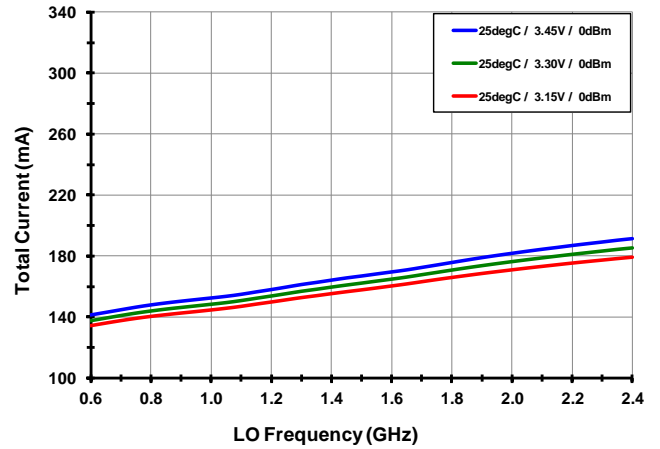

**I<sub>CC</sub> vs. LO level**

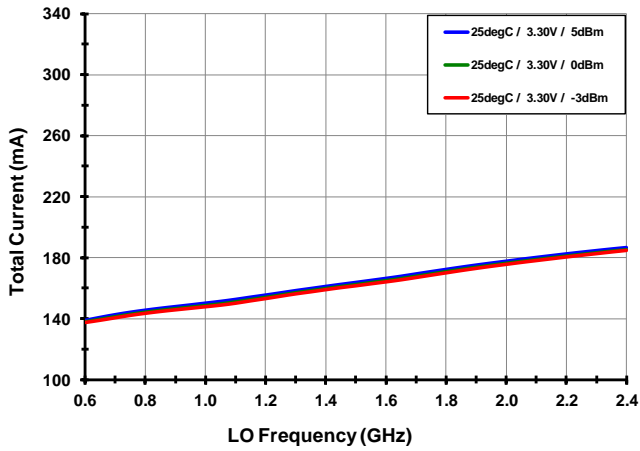

**Power Consumption vs. T<sub>AMB</sub>**

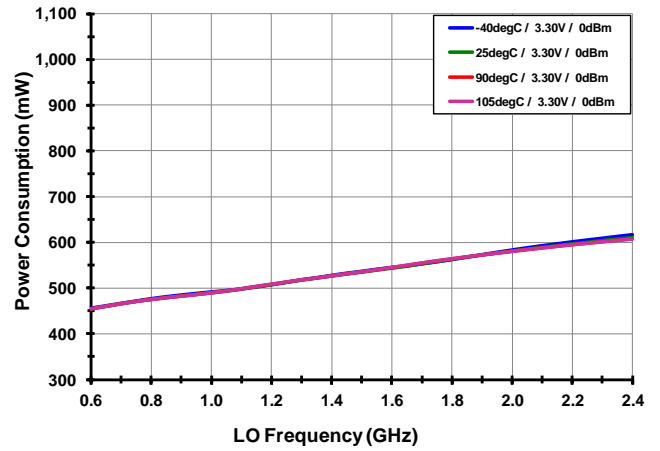

**Power Consumption vs. V<sub>CC</sub>**

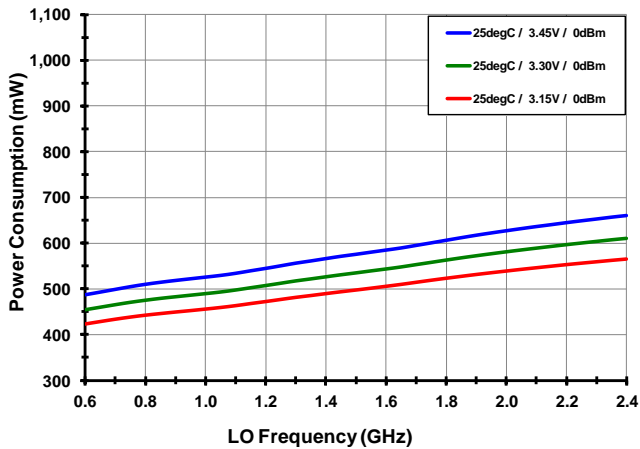

**Power Consumption vs. LO level**

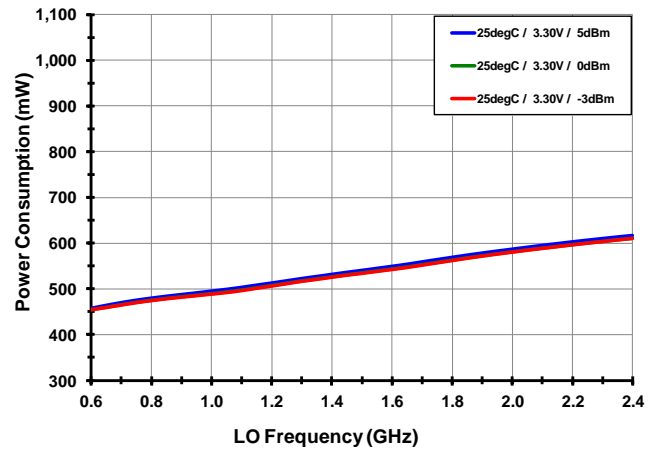

## TYPICAL OPERATING CURVES (-3-)

Gain vs.  $T_{AMB}$

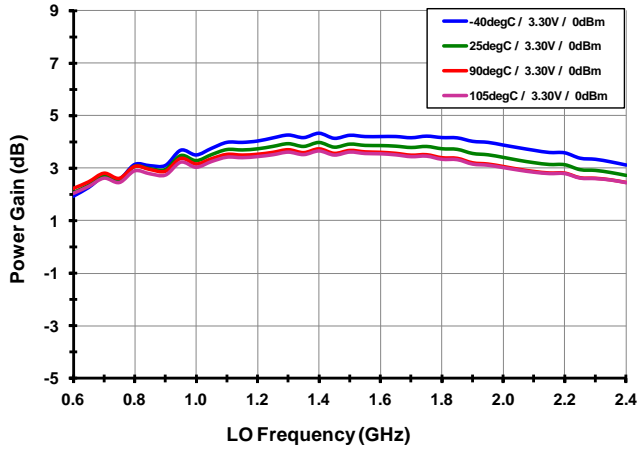

Gain vs.  $V_{CC}$

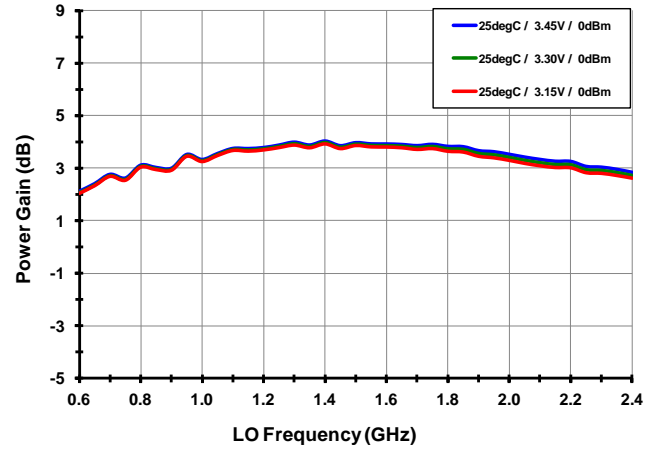

Gain vs. LO level

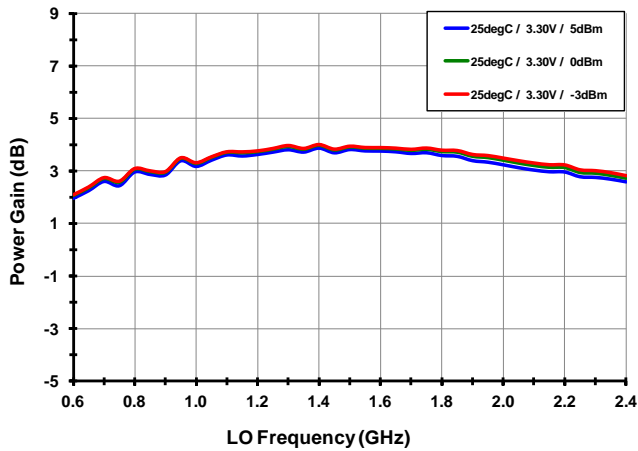

RF Output Power vs.  $T_{AMB}$

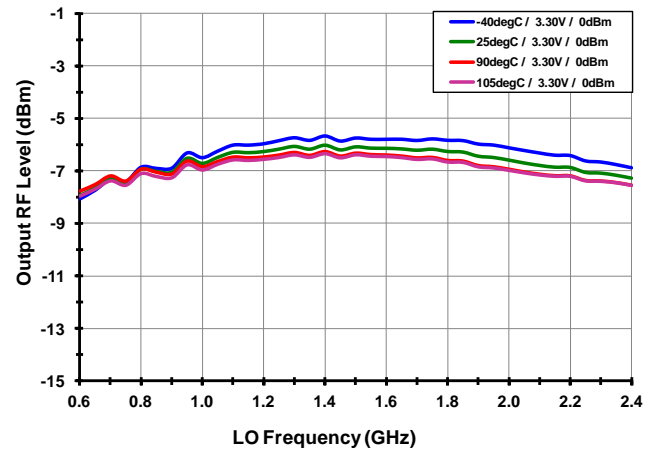

RF Output Power vs.  $V_{CC}$

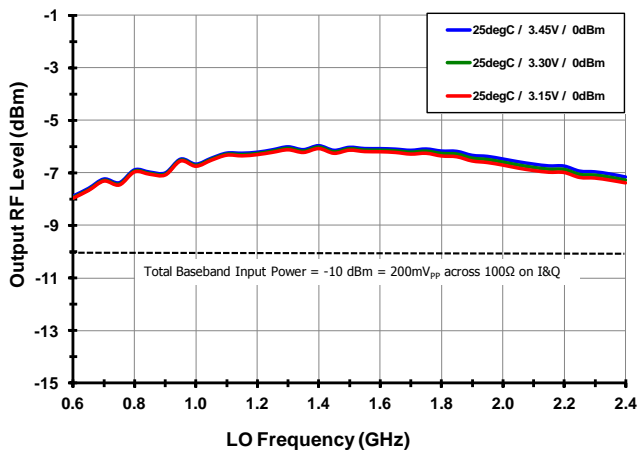

RF Output Power vs. LO level

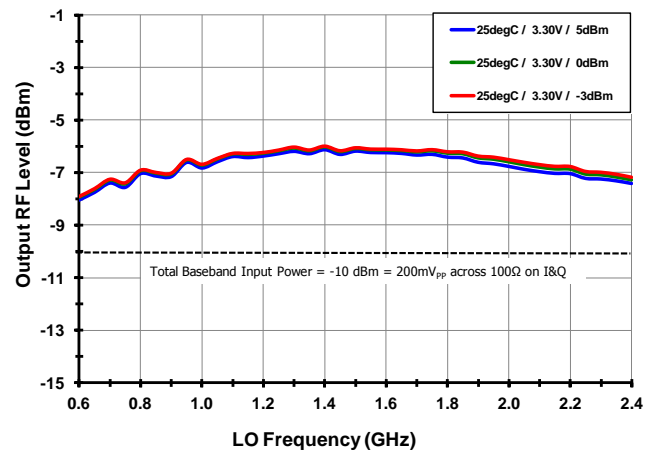



## TYPICAL OPERATING CURVES (-4-)

### Unadjusted LO Suppression vs. $T_{AMB}$

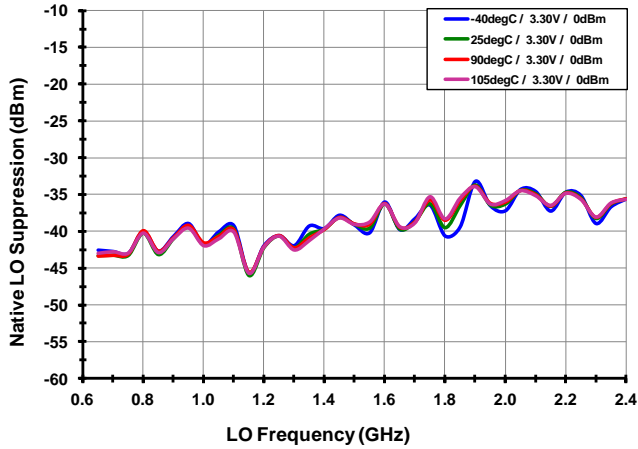

### Unadjusted LO Suppression vs. $V_{CC}$

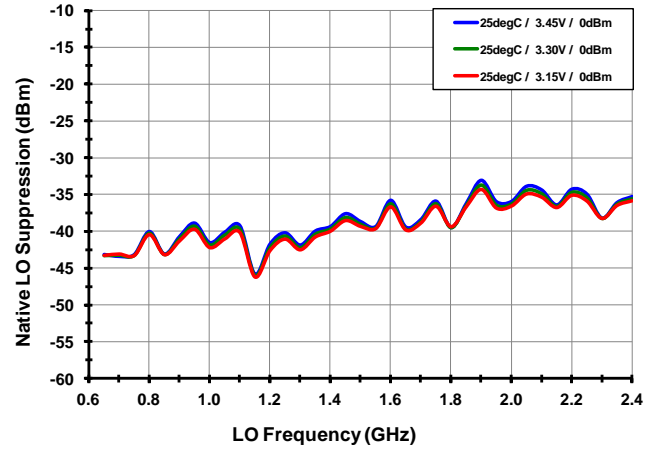

### Unadjusted LO Suppression vs. LO level

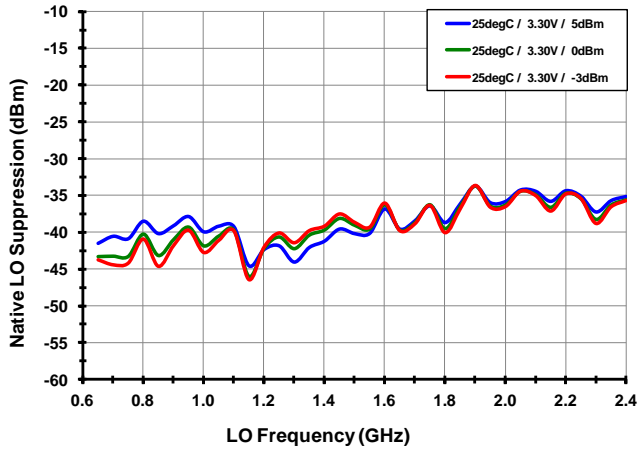

### Unadjusted Sideband Suppression vs. $T_{AMB}$

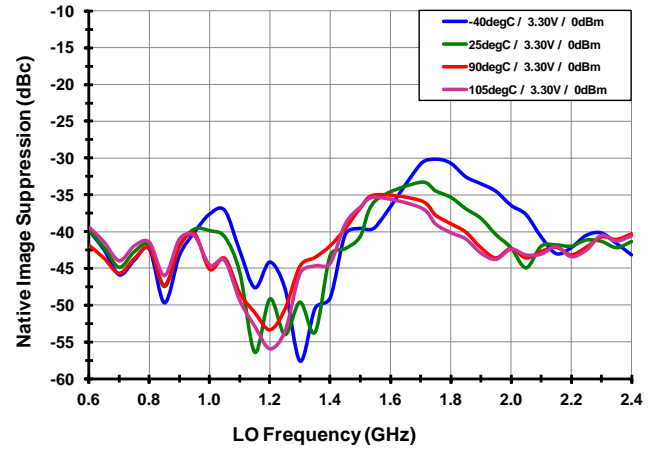

### Unadjusted Sideband Suppression vs. $V_{CC}$

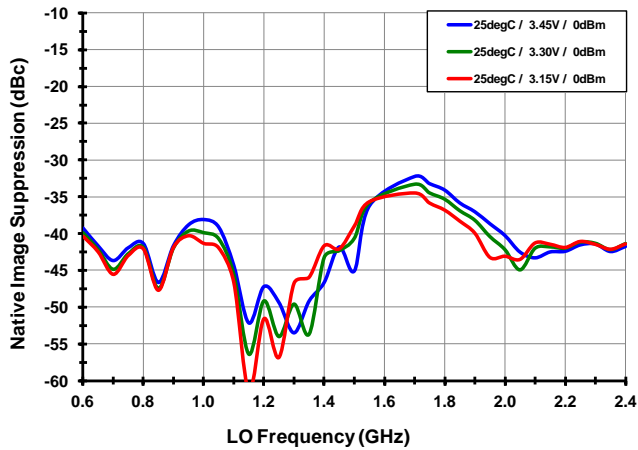

### Unadjusted Sideband Suppression vs. LO level

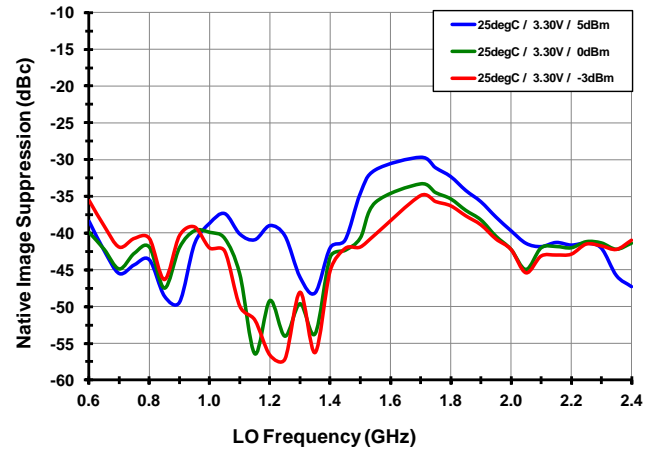

## TYPICAL OPERATING CURVES (-5-)

### Baseband 2<sup>nd</sup> Harmonic vs. T<sub>AMB</sub>

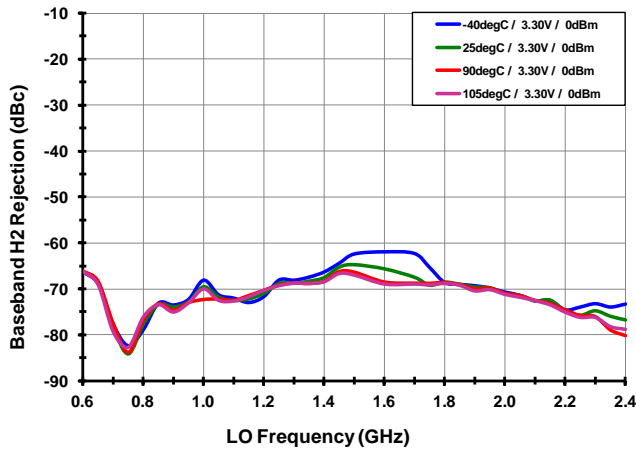

### Baseband 2<sup>nd</sup> Harmonic vs. V<sub>CC</sub>

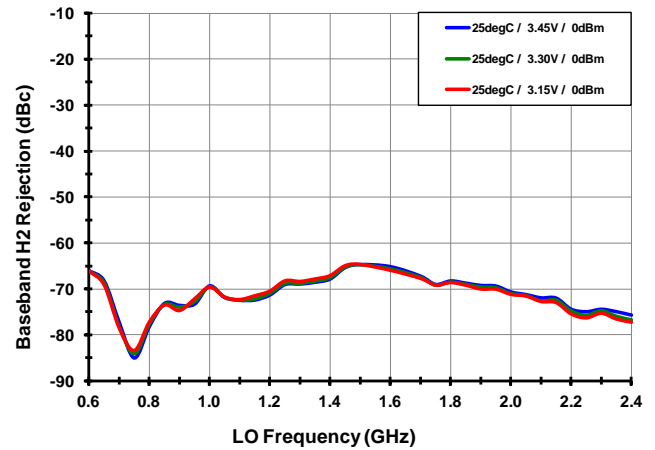

### Baseband 2<sup>nd</sup> Harmonic vs. LO level

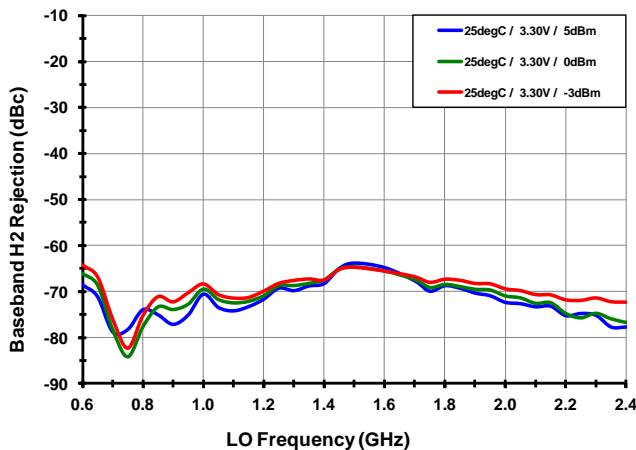

### Baseband 3<sup>rd</sup> Harmonic vs. T<sub>AMB</sub>

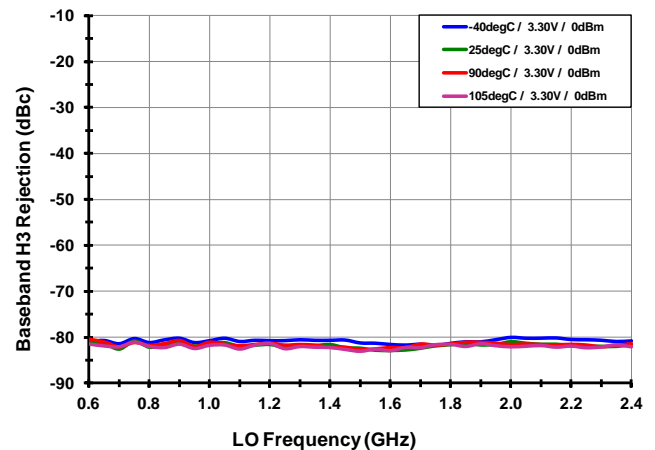

### Baseband 3<sup>rd</sup> Harmonic vs. V<sub>CC</sub>

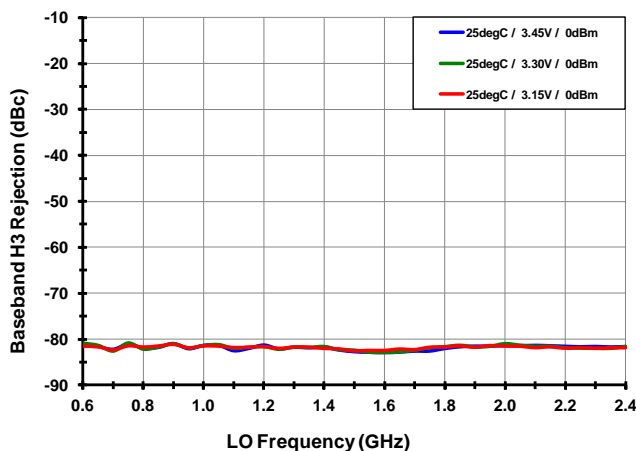

### Baseband 3<sup>rd</sup> Harmonic vs. LO level

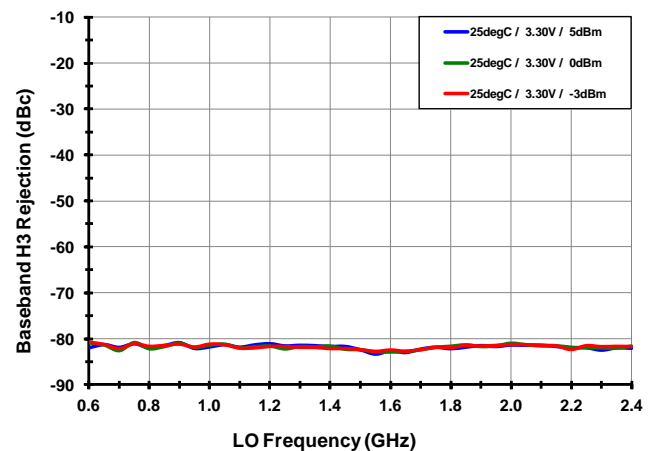

## TYPICAL OPERATING CURVES (-6-)

### LO Leakage (Carrier) Nulling

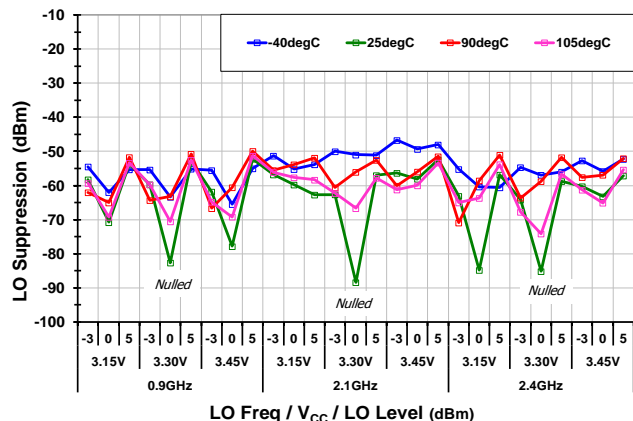

### Image (Sideband) Nulling

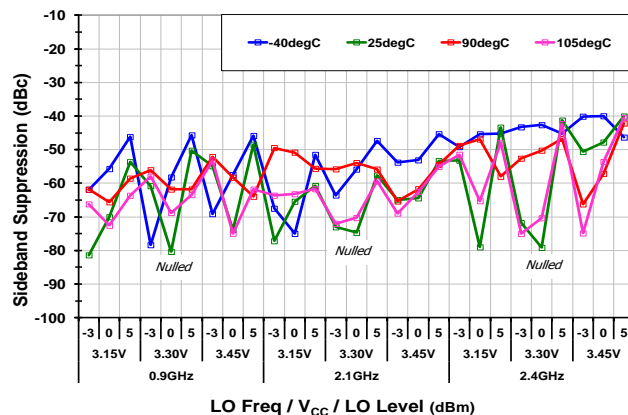

### Gain & IP3O Histograms [F<sub>LO</sub> = 1.95G, N = 1080]

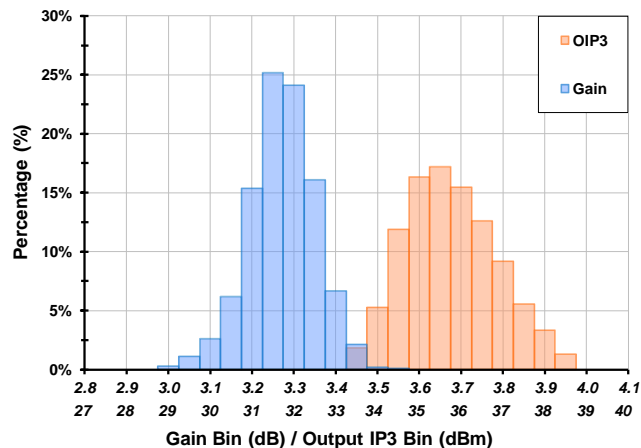

### LO & Image Histograms [F<sub>LO</sub> = 1.95G, N = 1080]

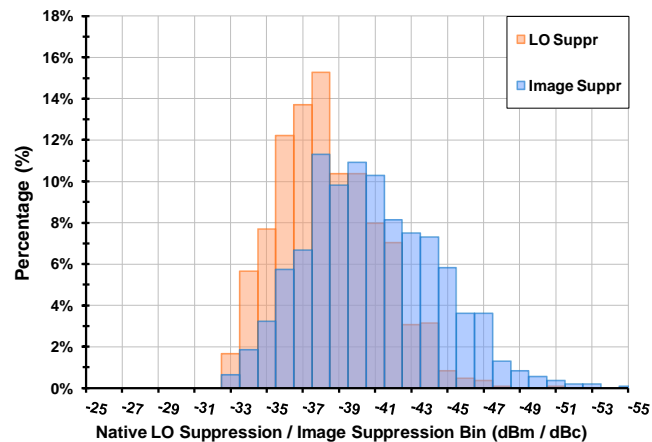

### Performance vs. V<sub>CM</sub> [Native LO & Image Suppression]

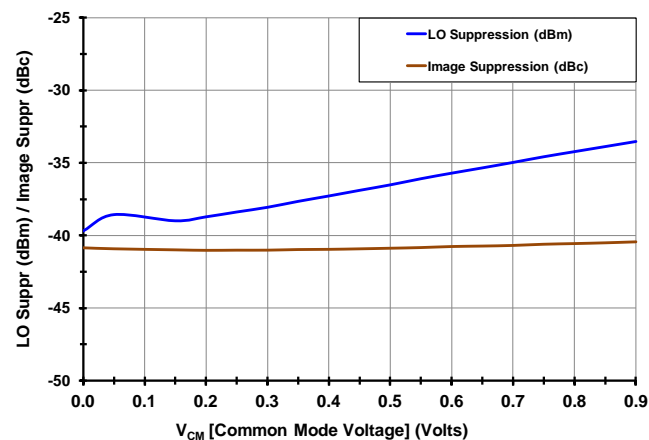

### Performance vs. V<sub>CM</sub> [Gain, IP3, IP2, F<sub>LO</sub> = 1.95G]

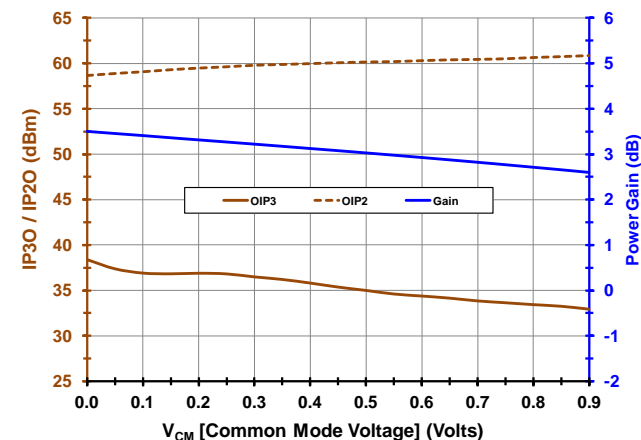

## TYPICAL OPERATING CURVES (-7-)

### Output Noise vs. Frequency

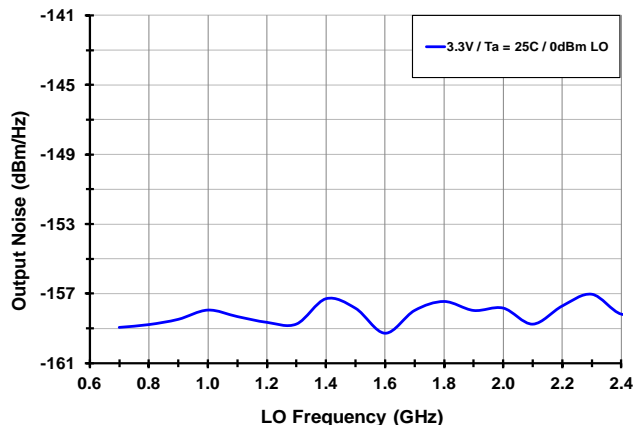

### Output Noise vs. P<sub>OUT</sub> [V<sub>CC</sub> = 3.3V, T<sub>AMB</sub> = 25C]

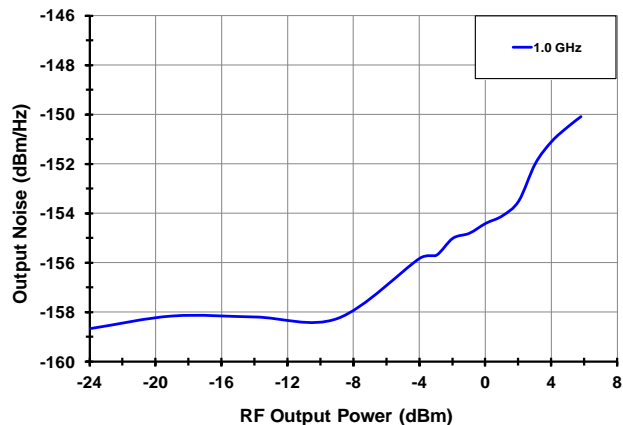

### Input Bandwidth (fixed LO = 2.092 GHz)

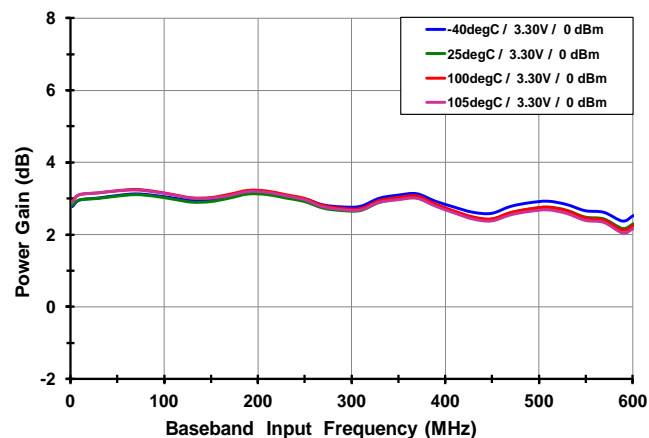

### LO & RF Port Return Loss

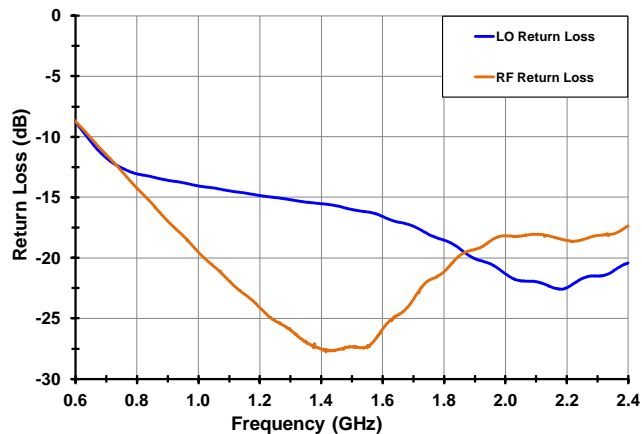

### I&Q Input Parallel Resistance/Capacitance

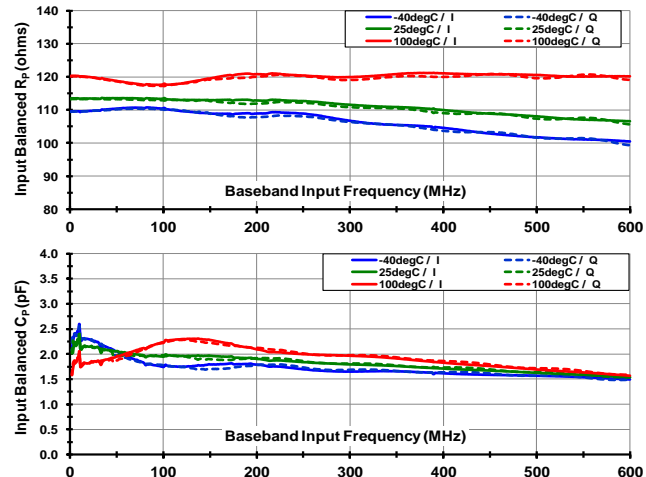

### 1dB Compression

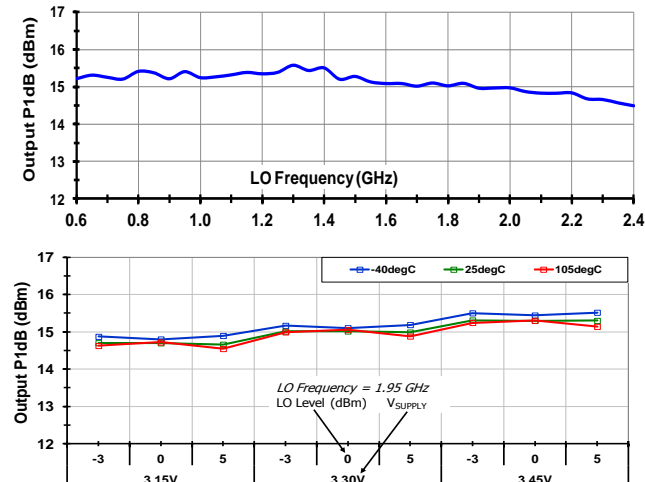

## GENERIC DAC INTERFACE

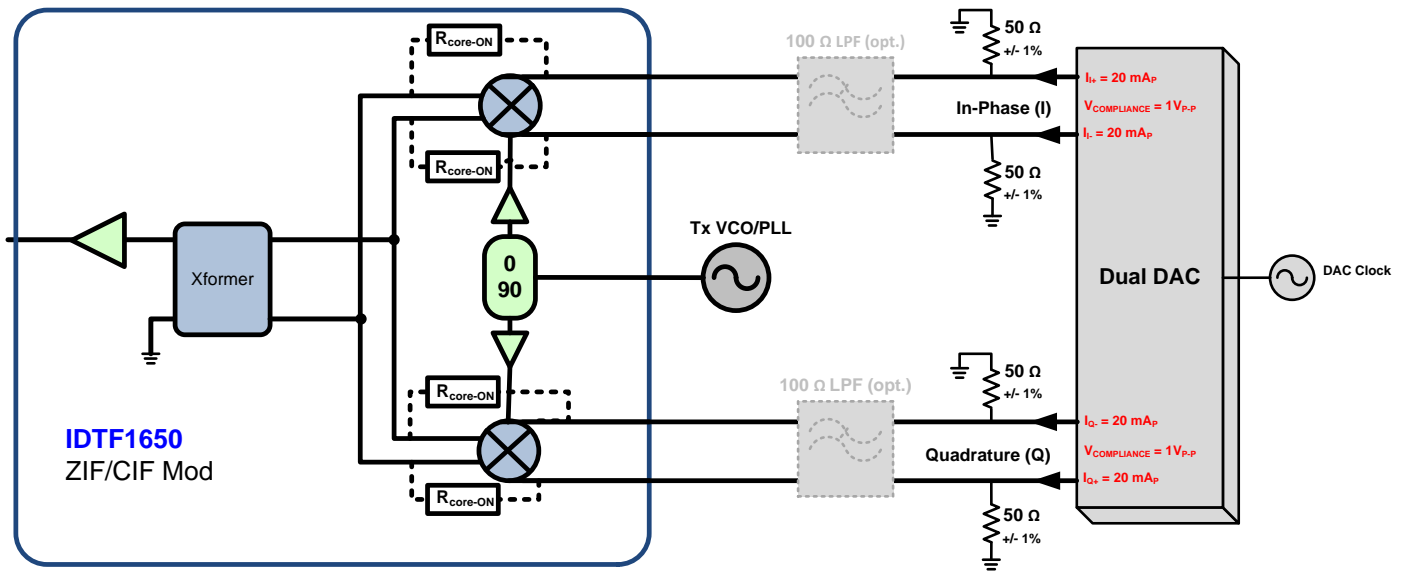

### PACKAGE DRAWING (4X4 24 PIN)

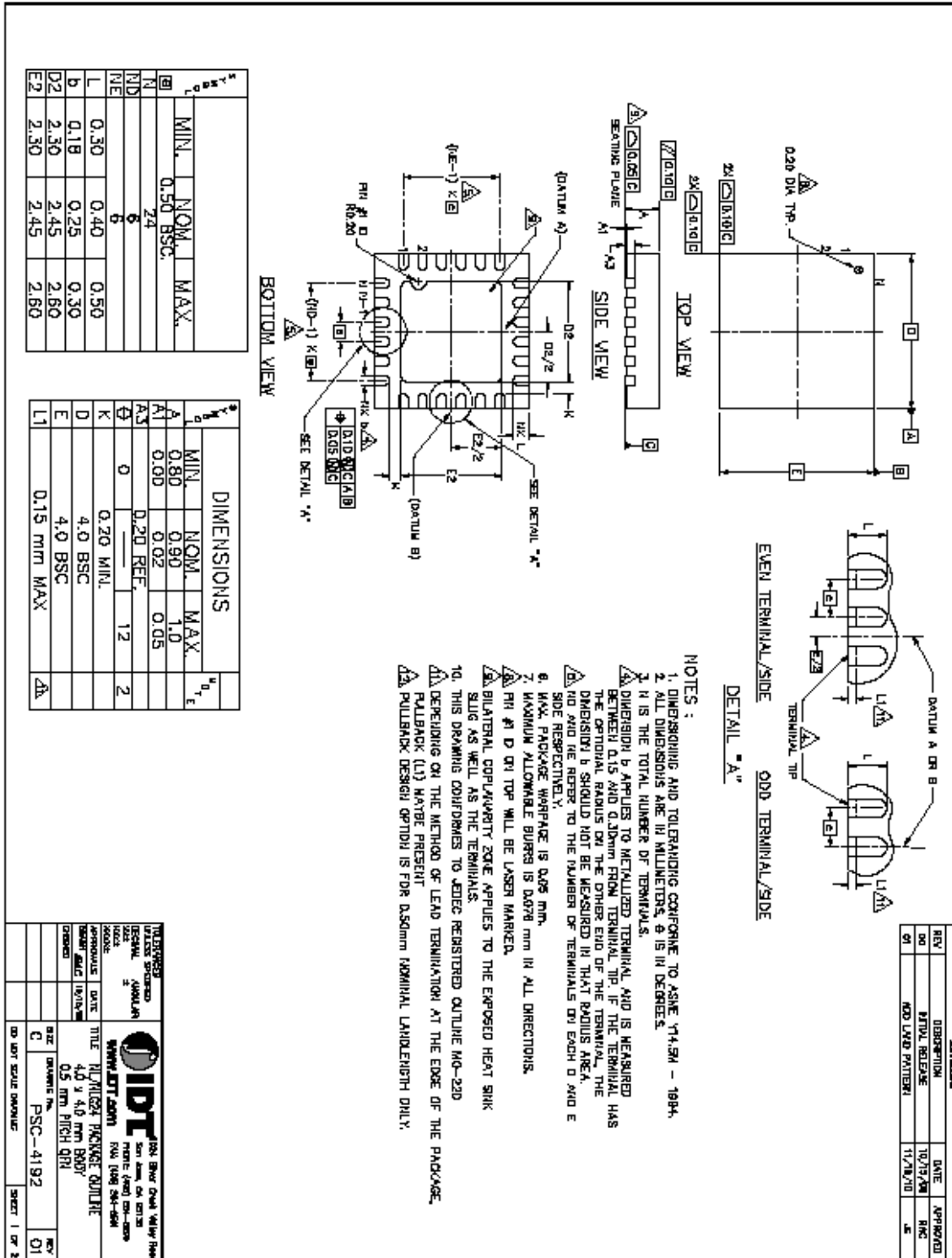

### PIN DIAGRAM

#### TOP View

(looking through the top of the package)

**BLACK** denotes recommended external connection

**[RED]** denotes internal connection

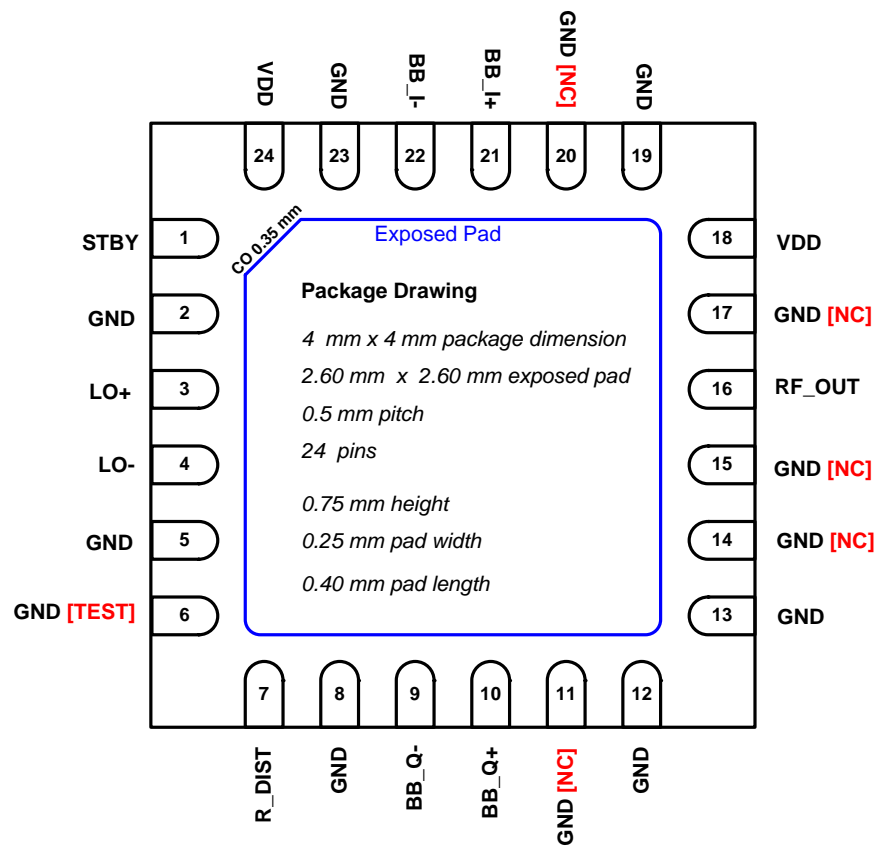

**PIN DESCRIPTIONS**

<b>Pins</b>	<b>Name</b>	<b>Function</b>
1	STBY	STBY Mode. Pull this pin high for Standby Mode (<15 mA). Pull low or ground for Normal Operation.
2, 5, 8, 12, 13, 19, 23	GND	Ground these pins.
11, 14, 15, 17, 20	NC	IDT recommends to ground these pins.
3, 4	LO+, LO-	Local oscillator (LO) 50 ohm differential or 25ohm each pin single-ended input. Pins should be ac-coupled. For 50 ohm single-ended operation, ac-couple USED Pin to 50 ohm termination and ac-couple UNUSED pin to GND.
6	TEST	Test pin. Ground this pin.
7	R_DIST	Connect the specified resistor from this pin to ground to set the RF distortion amplifier current.
9, 10	BB_Q-, BB_Q+	<i>Quadrature</i> differential baseband input. Internally matched to 100 ohms.
16	RF_OUT	RF output. Must be ac-coupled.
18, 24	VDD	Power Supply. Bypass to GND with capacitors as shown in the Typical Application Circuit as close to pin as possible.
21, 22	BB_I+, BB_I-	<i>In-Phase</i> differential baseband input. Internally matched to 100 ohms.
	— EP	Exposed Pad. Internally connected to GND. Solder this exposed pad to a PCB pad that uses multiple ground vias to provide heat transfer out of the device into the PCB ground planes. These multiple via grounds are also required to achieve the specified RF performance.



### EVKIT SCHEMATIC

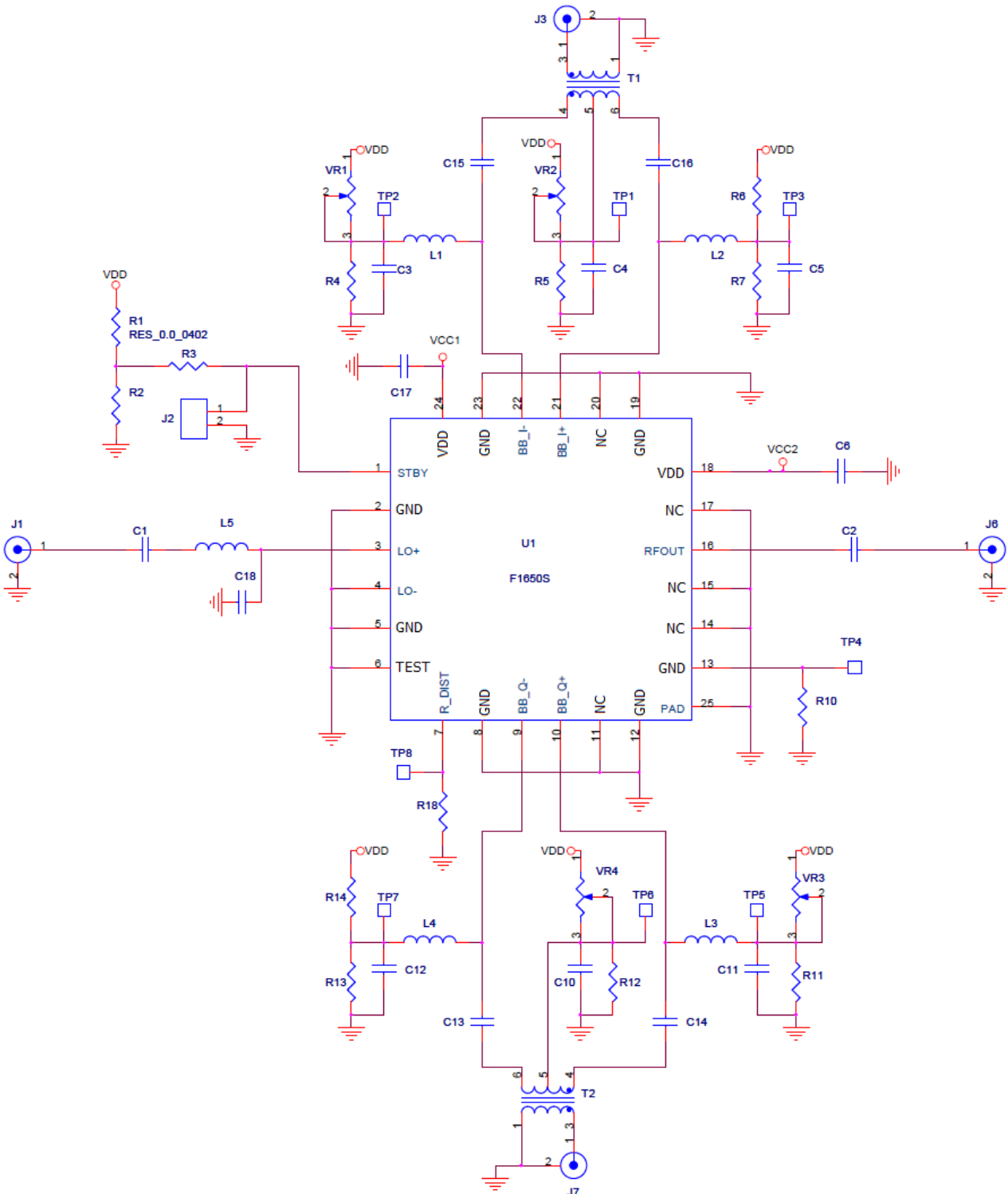

## EVKIT SCHEMATIC (CONTINUED)

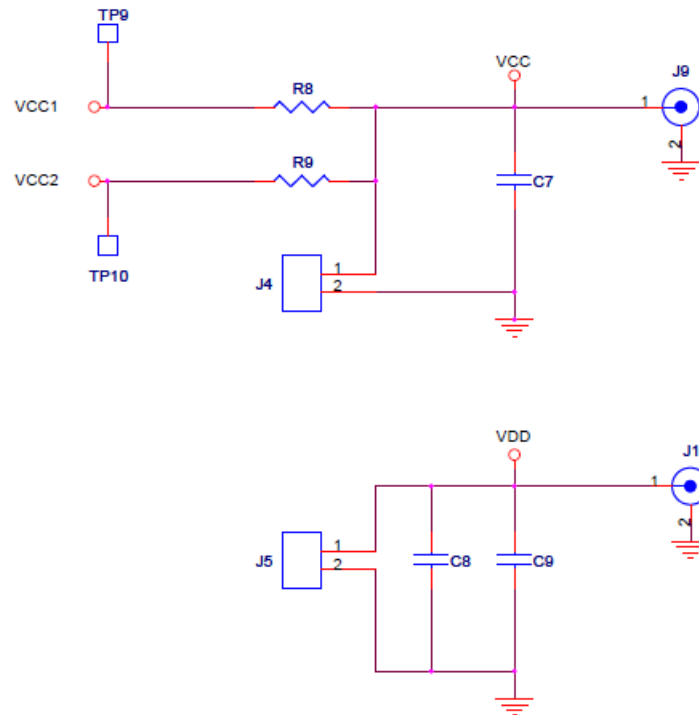

## POWER SUPPLIES

All supply pins should be bypassed with external capacitors to minimize noise and fast transients. Supply noise can degrade noise figure and fast transients can trigger ESD clamps and cause them to fail. Supply voltage change or transients should have a slew rate smaller than 1V/20uS. In addition, all control pins should remain at 0V (+/-0.3V) while the supply voltage ramps or while it returns to zero.

### EVKIT BOM

F1650 SE  
10/21/2013

Item #	Value	Size/Rev	Desc	Mfr. Part #	Mfr.	Supplier Part #	Supplier	Part Reference	Qty
1	8pF	0402	CAP CER 8pF 0402 50V 5% COG	GRM1555C1H8R0DZ01D	MURATA	490-3212-1-ND	Digikey	C2	1
2	10nF	0402	CAP CER 10000PF 16V 10% X7R 0402	GRM155R71C103KA01D	MURATA	490-1313-1-ND	Digikey	C4,6,8,10,17	5
3	39pF	0402	CAP CER 39PF 50V 5% COG 0402	GRM1555C1H390JZ010	MURATA	490-1286-1-ND	Digikey	C1	1
4	0.6pF	0402	CAP CER 8pF 0402 50V 5% COG	GJM1555C1HR60BB01D	MURATA	490-6078-1-ND	Digikey	C18	1
5	0.1uF	0402	CAP CER 0.1UF 16V 10% X7R 0402	GRM155R71C104KA88D	MURATA	490-3261-1-ND	Digikey	C7,9	2
6	0	0402	RES 0.0 OHM 1/10W 0402 SMD	ERJ-2GE0R00X	Panasonic	P0.0JCT-ND	Digikey	R3,8,9,C13-16	7
7	6.34K	0402	RES 6.34K OHM 1/10W 1% 0402 SMD	ERJ-2RK6341X	Panasonic	P6.34KLCCT-ND	Digikey	R18	1
8	24.9	1206	RES TF 24.9 OHM 1% 0.25W 1206	RMCF1206FT24R9CT-ND	RMCF	RMCF1206FT24R	Digikey	R5,12	2
9	47K	0402	RES 47.0K OHM 1/16W 1% 0402 SMD	RC0402FR-0747KL	Yageo	311-47.0KLRCT-	Digikey	R1	1
10	1K	2719	TRIMMER 1K OHM 0.25W SMD	TS63Y-1.0KCT-ND	Vishay/Sfernice	TS63Y102KR10	Digikey	VR2,4	2
11	1.8n	0402	0402CS Ceramic Chip Inductor	0402CS-1N8XJLU	CoilCraft	0402CS-1N8XJLU	CoilCraft	L5	1
12	Header 2 Pin	TH 2	CONN HEADER VERT SGL 2POS GOLD	961102-6404-AR	3M	3M9447-ND	Digikey	J2,5,8,9	4
13	SMA_END_LAUNCH	.062	SMA_END_LAUNCH (Small)	142-0711-821	Emerson Johnson	530-142-0711-821	Mouser	J3,4,7,10	4
14	SMA_END_LAUNCH	.062	SMA_END_LAUNCH (Big)	142-0701-851	Emerson Johnson	530-142-0701-851	Mouser	J1,6	2
15	2:1 Balun	SM-22	2:1 Center Tap Balun	ADT2-1T+	Mini Circuits	ADT2-1T+	Mini Circuits	T1,2	2
16	F1650	QFN-24	IQ MOD	F1650	IDT	F1650-010	IDT	U1	1
17	PCB	02	Printed Circuit Board	F1650 SE EVKIT REV 02	Coastal Circuits				1
18	BOM	05	Bill Of Material						
19	DNP	2719						VR1,3	
20	DNP	0402						C3,5,11,12	
21	DNP	0402						R2,6,10,14,16	
22	DNP	1206						R4,7,11,13	
								<b>TOTAL</b>	<b>38</b>

### APPLYING $V_{CM}$ AT THE BASEBAND INPUTS

With L1, L2, L3, and L4 unpopulated, the common mode voltage is set by VR2 and VR4. The voltage set by VR2 has a DC path through the balun transformer T1 to pins BB\_I+ and BB\_I-, as highlighted. This also applies for VR4, T2, and pins BB\_Q+ and BB\_Q-. With this configuration, the same voltage will be applied to BB\_I+ and BB\_I- and the same voltage will be applied to BB\_Q+ and BB\_Q-. The I and Q common mode voltages may be different from each other to null LO (carrier) leakage.

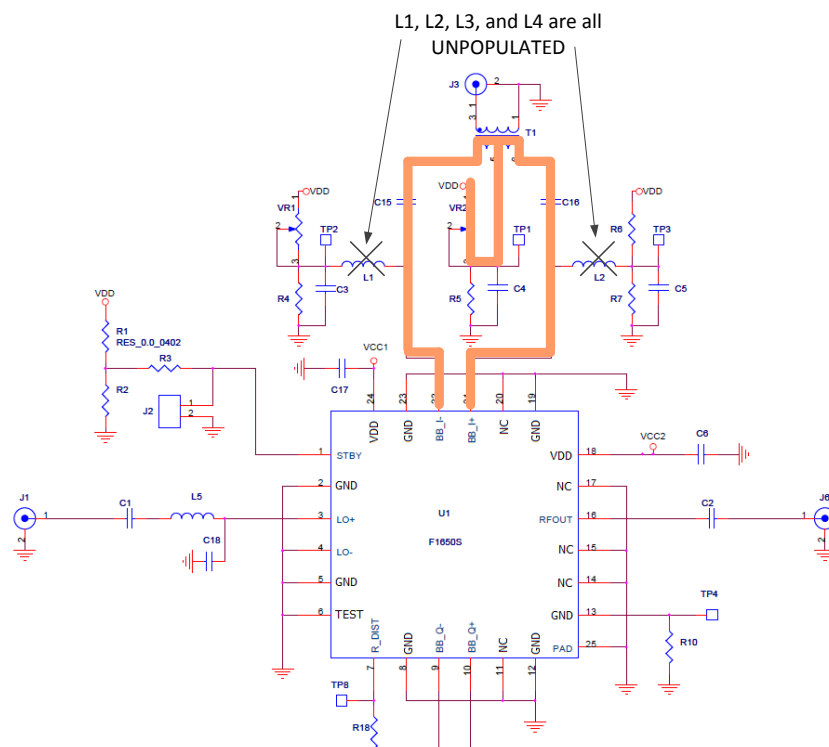

**EVKIT PICTURE:**

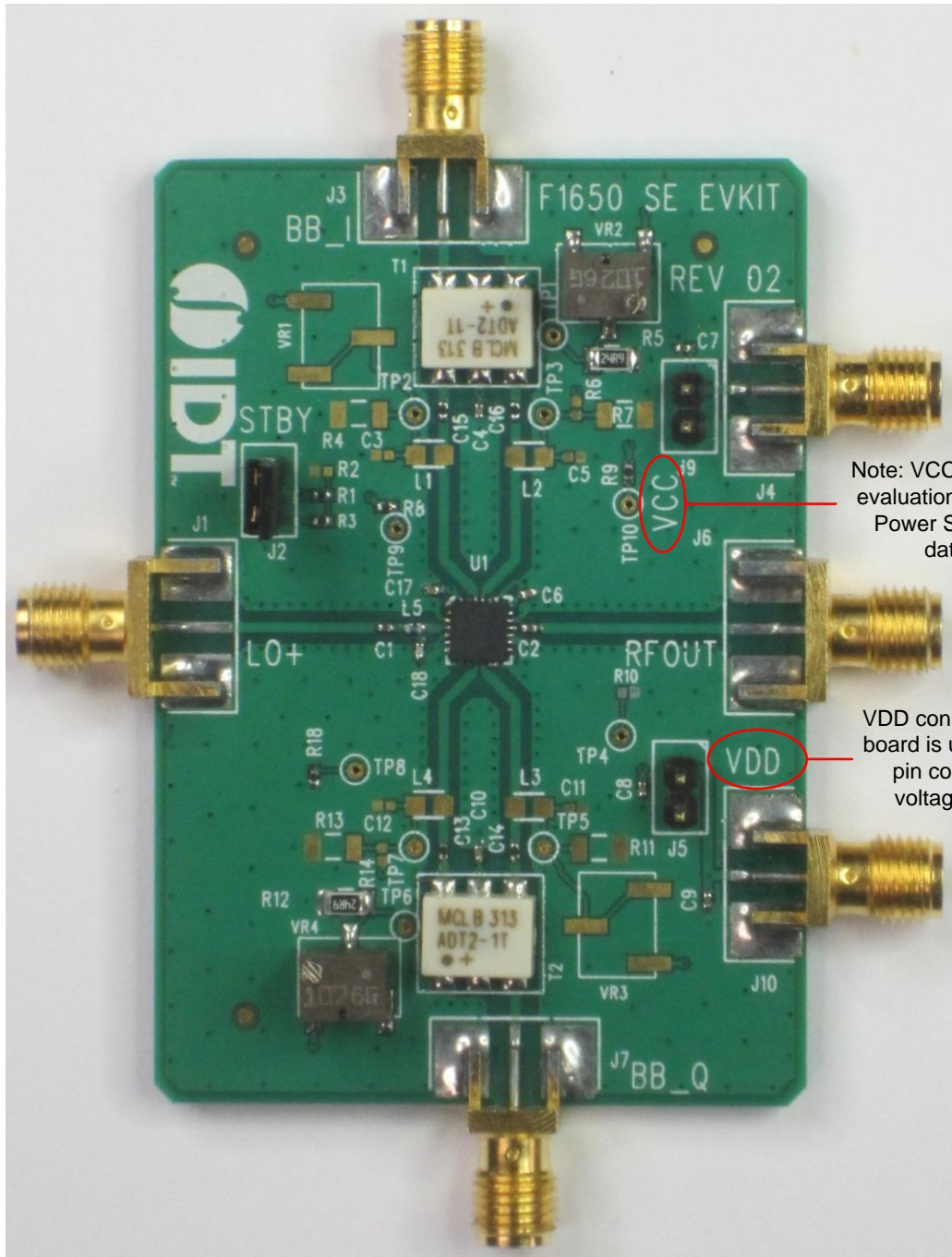

Note: VCC connection on evaluation board is VDD Power Supply on the datasheet.

VDD connection on evaluation board is used to set baseband pin common mode (CM) voltage (see schematic)

**TOP MARKINGS**

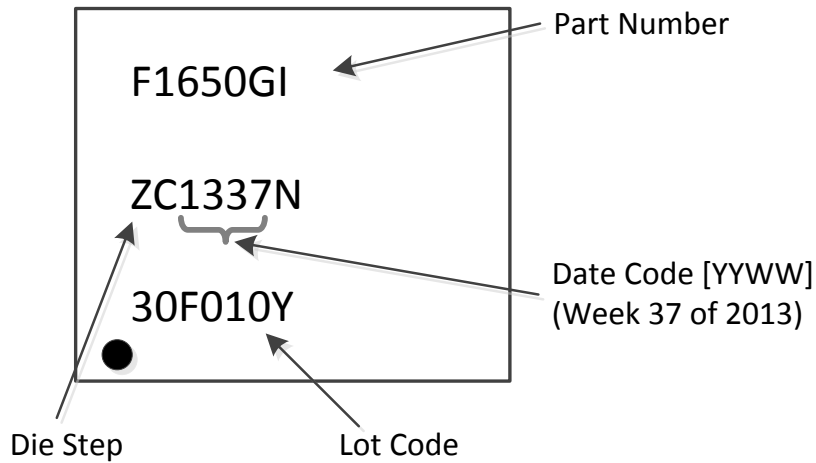

Компания «Океан Электроники» предлагает заключение долгосрочных отношений при поставках импортных электронных компонентов на взаимовыгодных условиях!

Наши преимущества:

- Поставка оригинальных импортных электронных компонентов напрямую с производств Америки, Европы и Азии, а так же с крупнейших складов мира;
- Широкая линейка поставок активных и пассивных импортных электронных компонентов (более 30 млн. наименований);
- Поставка сложных, дефицитных, либо снятых с производства позиций;
- Оперативные сроки поставки под заказ (от 5 рабочих дней);
- Экспресс доставка в любую точку России;
- Помощь Конструкторского Отдела и консультации квалифицированных инженеров;
- Техническая поддержка проекта, помощь в подборе аналогов, поставка прототипов;
- Поставка электронных компонентов под контролем ВП;
- Система менеджмента качества сертифицирована по Международному стандарту ISO 9001;
- При необходимости вся продукция военного и аэрокосмического назначения проходит испытания и сертификацию в лаборатории (по согласованию с заказчиком);
- Поставка специализированных компонентов военного и аэрокосмического уровня качества (Xilinx, Altera, Analog Devices, Intersil, Interpoint, Microsemi, Actel, Aeroflex, Peregrine, VPT, Syfer, Eurofarad, Texas Instruments, MS Kennedy, Miteq, Cobham, E2V, MA-COM, Hittite, Mini-Circuits, General Dynamics и др.);

Компания «Океан Электроники» является официальным дистрибьютором и эксклюзивным представителем в России одного из крупнейших производителей разъемов военного и аэрокосмического назначения «JONHON», а так же официальным дистрибьютором и эксклюзивным представителем в России производителя высокотехнологичных и надежных решений для передачи СВЧ сигналов «FORSTAR».



## JONHON

«JONHON» (основан в 1970 г.)

Разъемы специального, военного и аэрокосмического назначения:

(Применяются в военной, авиационной, аэрокосмической, морской, железнодорожной, горно- и нефтедобывающей отраслях промышленности)

«FORSTAR» (основан в 1998 г.)

ВЧ соединители, коаксиальные кабели, кабельные сборки и микроволновые компоненты:

(Применяются в телекоммуникациях гражданского и специального назначения, в средствах связи, РЛС, а так же военной, авиационной и аэрокосмической отраслях промышленности).



Телефон: 8 (812) 309-75-97 (многоканальный)

Факс: 8 (812) 320-03-32

Электронная почта: [ocean@oceanchips.ru](mailto:ocean@oceanchips.ru)

Web: <http://oceanchips.ru/>

Адрес: 198099, г. Санкт-Петербург, ул. Калинина, д. 2, корп. 4, лит. А