

# Analog Devices Welcomes Hittite Microwave Corporation

NO CONTENT ON THE ATTACHED DOCUMENT HAS CHANGED



**THIS PAGE INTENTIONALLY LEFT BLANK**

## 1dB LSB GaAs MMIC 3-BIT DIGITAL POSITIVE CONTROL ATTENUATOR, DC - 6GHz

### Typical Applications

The HMC468ALP3E is ideal for:

- Cellular; UMTS/3G Infrastructure
- Fixed Wireless & WLL
- Microwave Radio & VSAT
- Test Equipment

### Features

- 1 dB LSB Steps to 7 dB
- High IP3: +55 dBm
- ± 0.25 dB Typical Bit Error
- Single Control Line Per Bit
- Single +5V Supply
- 16 Lead 3x3 mm SMT Package: 9 mm<sup>2</sup>

### Functional Diagram

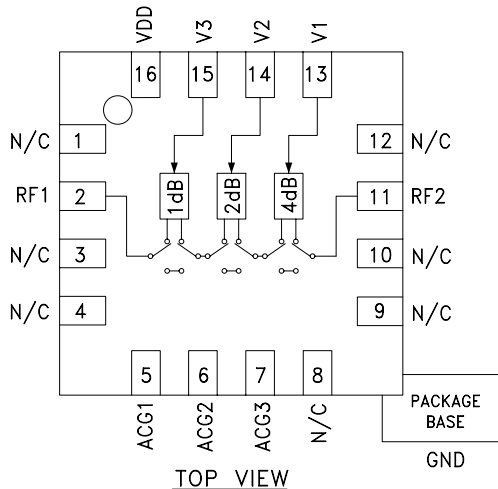

### General Description

The HMC468ALP3E is a broadband 3-bit GaAs IC digital attenuators in a low cost leadless surface mount package. Covering DC to 6.0 GHz, the insertion loss is less than 1 dB typical up to 4 GHz. The attenuator bit values are 1 (LSB), 2 and 4 dB for a total attenuation of 7 dB. Attenuation accuracy is excellent at ±0.4 dB typical step error with an IIP3 of +55 dBm. Three control voltage inputs, toggled between 0 and +5V, are used to select each attenuation state. A single Vdd bias of +5V is required.

### Electrical Specifications, $T_A = +25^\circ C$ , With $V_{dd} = +5V$ & $V_{ctl} = 0/+5V$

Parameter	Frequency (GHz)	Min.	Typ.	Max.	Units
Insertion Loss	DC - 2.5 GHz		0.5	1.0	dB
	2.5 - 4.5 GHz		0.7	1.2	dB
	4.5 - 6.0 GHz		0.9	1.4	dB
Attenuation Range	DC - 6 GHz		7		dB
Return Loss (RF1 & RF2, All Atten. States)	DC - 6 GHz		20		dB
Attenuation Accuracy: (Referenced to Insertion Loss)	All States	DC - 2.5 GHz	± 0.2 + 2% of Atten. Setting Max.		dB
	1 - 4 dB States	2.5 - 6.0 GHz	± 0.3 + 3% of Atten. Setting Max.		dB
	5 - 7 dB States	2.5 - 6.0 GHz	± 0.4 + 4% of Atten. Setting Max.		dB
Input Power for 0.1 dB Compression	0.25 - 6.0 GHz		26		dBm
Input Third Order Intercept Point (Two-Tone Input Power= 0 dBm Each Tone)	0.25 - 6.0 GHz		55		dBm
Switching Characteristics	DC - 6 GHz				
		tRISE, tFALL (10/90% RF)		60	ns
		tON, tOFF (50% CTL to 10/90% RF)		80	ns

\* Bypass capacitor connecting ACG1, ACG2 & ACG3 to RF ground required per pin description herein.



## 1dB LSB GaAs MMIC 3-BIT DIGITAL POSITIVE CONTROL ATTENUATOR, DC - 6GHz

### Insertion Loss

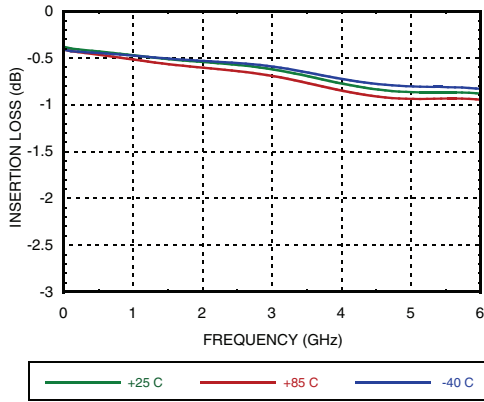

### Return Loss RF1, RF2 (Only Major States are Shown)

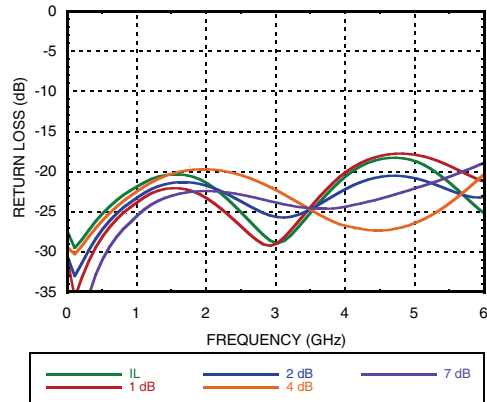

### Normalized Attenuation (Only Major States are Shown)

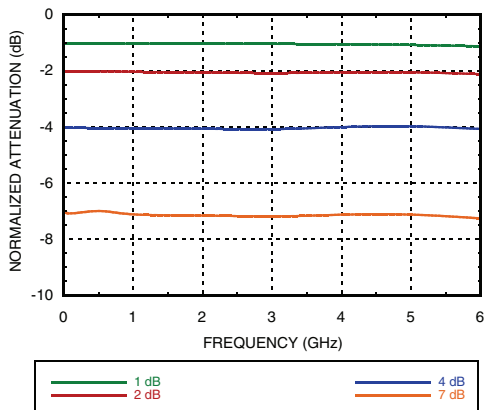

### Bit Error vs. Attenuation State

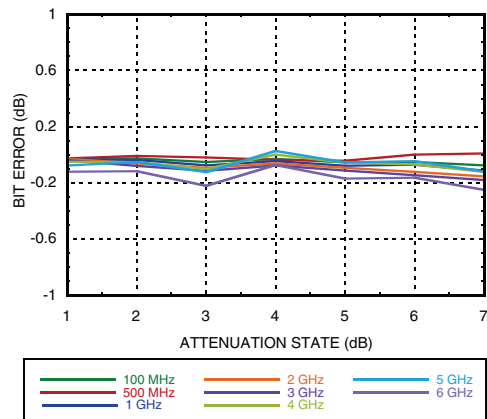

### Bit Error vs. Frequency (Only Major States are Shown)

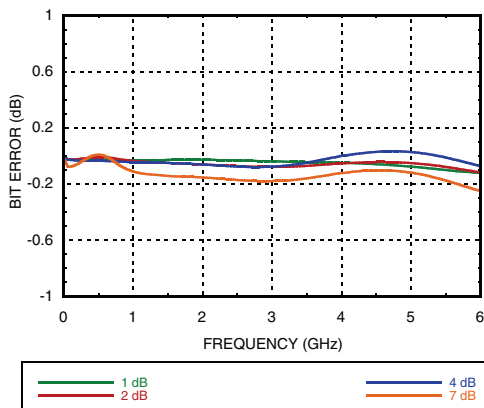

### Relative Phase vs. Frequency (Only Major States are Shown)

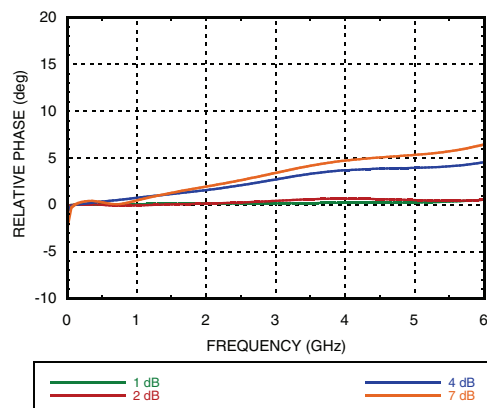



## 1dB LSB GaAs MMIC 3-BIT DIGITAL POSITIVE CONTROL ATTENUATOR, DC - 6GHz

### Step Error Between Successive Attenuation States

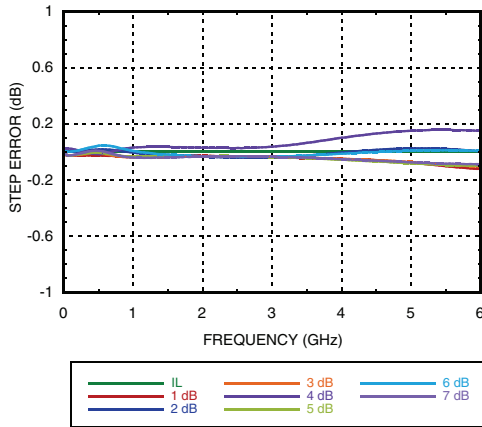

### Truth Table

Control Voltage Input			Attenuation Setting RF1 - RF2
V1 4 dB	V2 2 dB	V3 1 dB	
High	High	High	Reference I.L.
High	High	Low	1 dB
High	Low	High	2 dB
Low	High	High	4 dB
Low	Low	Low	7 dB

Any combination of the above states will provide an attenuation approximately equal to the sum of the bits selected.

### Bias Voltage & Current

Vdd Range= +5.0 Vdc ± 10%		
Vdd (Vdc)	Idd (Typ.) (mA)	Idd (Max.) (mA)
+5.0	1.05	1.8

### TTL/CMOS Control Voltages

State	Bias Condition
Low	0 to 0.8 Vdc @ -0.05 uA Typ.
High	+2.0 to +5.0 Vdc @ 40 uA Typ.

**1dB LSB GaAs MMIC 3-BIT DIGITAL  
POSITIVE CONTROL ATTENUATOR, DC - 6GHz**
**Absolute Maximum Ratings**

RF Input Power	+30 dBm
Control Voltage (V1 to V3)	-0.5 Vdc to Vdd +1 Vdc
Bias Voltage (Vdd)	+7 Vdc
Channel Temperature	150 °C
Continuous Pdiss (T = 85 °C) (derate 10. 1mW/ °C above 85 °C)	0.657 W
Thermal Resistance	99 °C/W
Storage Temperature	-65 to +150 °C
Operating Temperature	-40 to +85 °C
ESD Sensitivity (HBM)	Class 1A

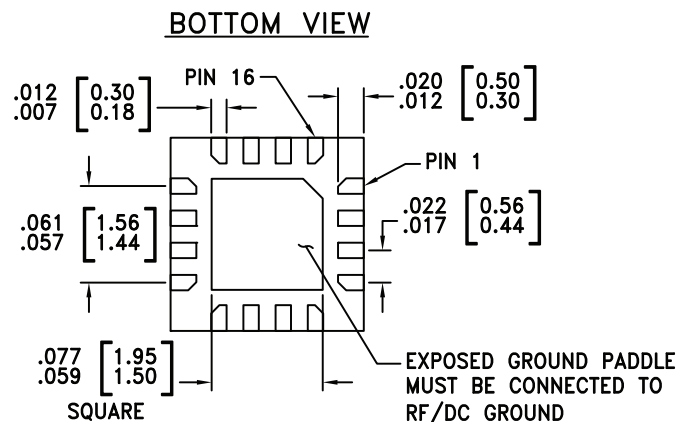
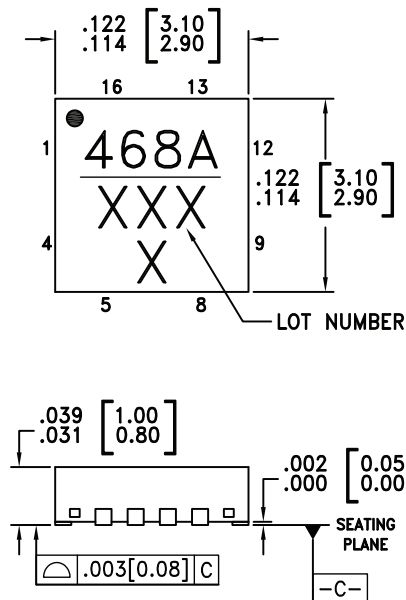
**ELECTROSTATIC SENSITIVE DEVICE  
OBSERVE HANDLING PRECAUTIONS**
**Outline Drawing**

**NOTES:**

1. LEADFRAME MATERIAL: COPPER ALLOY
2. DIMENSIONS ARE IN INCHES [MILLIMETERS]
3. LEAD SPACING TOLERANCE IS NON-CUMULATIVE
4. PAD BURR LENGTH SHALL BE 0.15mm MAXIMUM.  
PAD BURR HEIGHT SHALL BE 0.05mm MAXIMUM.
5. PACKAGE WARP SHALL NOT EXCEED 0.05mm.
6. ALL GROUND LEADS AND GROUND PADDLE MUST BE  
SOLDERED TO PCB RF GROUND.
7. REFER TO HITTITE APPLICATION NOTE FOR SUGGESTED  
LAND PATTERN.

**Package Information**

Part Number	Package Body Material	Lead Finish	MSL Rating	Package Marking <sup>[1]</sup>
HMC468ALP3E	RoHS-compliant Low Stress Injection Molded Plastic	100% matte Sn	MSL1 <sup>[2]</sup>	468A XXXX



[1] 4-Digit lot number XXXX

[2] Max peak reflow temperature of 260 °C

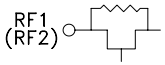
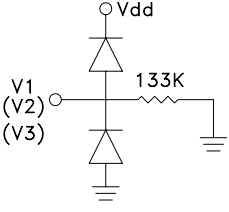

## 1dB LSB GaAs MMIC 3-BIT DIGITAL POSITIVE CONTROL ATTENUATOR, DC - 6GHz

### Pin Descriptions

Pin Number	Function	Description	Interface Schematic
1, 3, 4, 8, 9, 10, 12	N/C	These pins should be connected to PCB RF ground to maximize performance.	
2, 11	RF1, RF2	This pin is DC coupled and matched to 50 Ohm. Blocking capacitors are required	
13 - 15	V1 - V3	See truth table and control voltage table.	
5 - 7	ACG1 - ACG3	External capacitor to ground is required. Select value for lowest frequency of operation. Place capacitor as close to pins as possible.	
16	Vdd	Supply Voltage	
	GND	Package bottom has an exposed metal paddle that must be connected to RF/DC ground.	

### Application Circuit

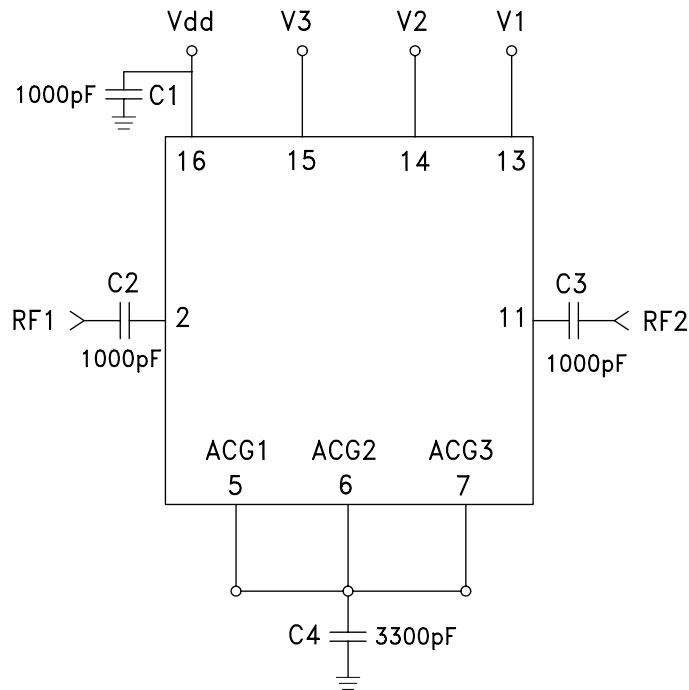



## 1dB LSB GaAs MMIC 3-BIT DIGITAL POSITIVE CONTROL ATTENUATOR, DC - 6GHz

### Evaluation PCB

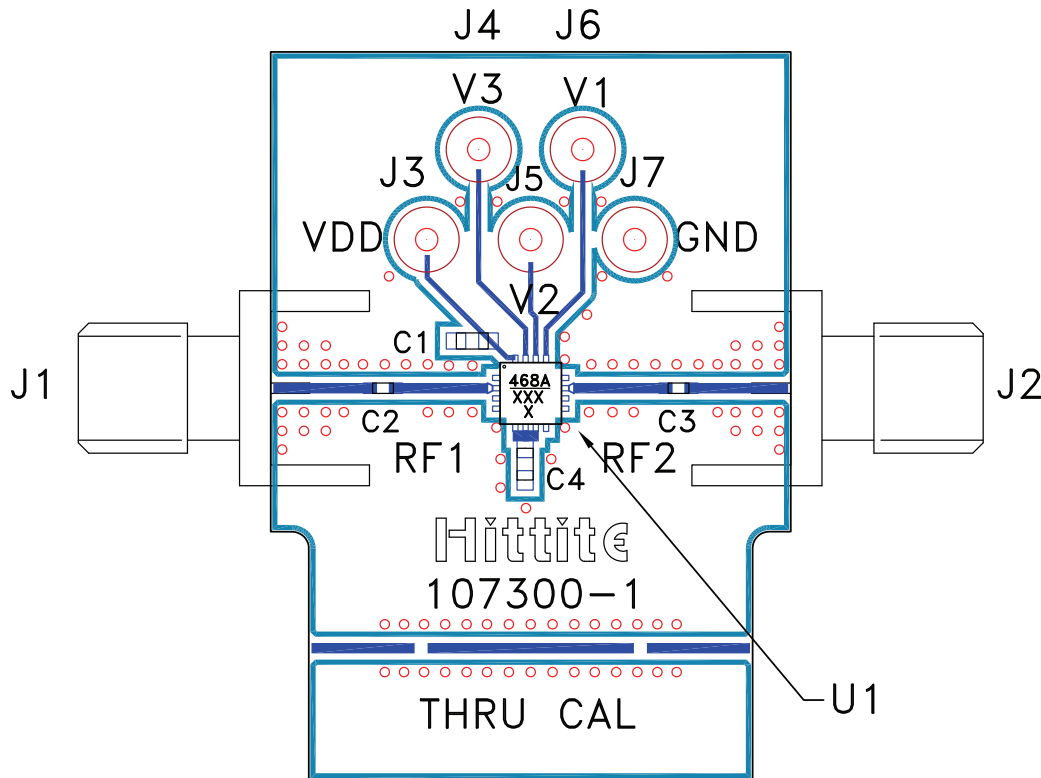

### List of Materials for Evaluation PCB 107302 - HMC468ALP3 [1]

Item	Description
J1 - J2	PCB Mount SMA Connector
J3 - J7	DC Pin
C1	1000 pF Capacitor, 0603 Pkg.
C2, C3	100 pF Capacitor, 0402 Pkg.
C4	3300 pF Capacitor, 0603 Pkg.
U1	HMC468ALP3E Digital Attenuator
PCB [2]	107300 Evaluation PCB

[1] Reference this number when ordering complete evaluation PCB

[2] Circuit Board Material: Rogers 4350

The circuit board used in the application should use RF circuit design techniques. Signal lines should have 50 Ohm impedance while the package ground leads and exposed paddle should be connected directly to the ground plane similar to that shown. A sufficient number of via holes should be used to connect the top and bottom ground planes. The evaluation circuit board shown is available from Hittite upon request.



Компания «Океан Электроники» предлагает заключение долгосрочных отношений при поставках импортных электронных компонентов на взаимовыгодных условиях!

Наши преимущества:

- Поставка оригинальных импортных электронных компонентов напрямую с производств Америки, Европы и Азии, а так же с крупнейших складов мира;
- Широкая линейка поставок активных и пассивных импортных электронных компонентов (более 30 млн. наименований);
- Поставка сложных, дефицитных, либо снятых с производства позиций;
- Оперативные сроки поставки под заказ (от 5 рабочих дней);
- Экспресс доставка в любую точку России;
- Помощь Конструкторского Отдела и консультации квалифицированных инженеров;
- Техническая поддержка проекта, помощь в подборе аналогов, поставка прототипов;
- Поставка электронных компонентов под контролем ВП;
- Система менеджмента качества сертифицирована по Международному стандарту ISO 9001;
- При необходимости вся продукция военного и аэрокосмического назначения проходит испытания и сертификацию в лаборатории (по согласованию с заказчиком);
- Поставка специализированных компонентов военного и аэрокосмического уровня качества (Xilinx, Altera, Analog Devices, Intersil, Interpoint, Microsemi, Actel, Aeroflex, Peregrine, VPT, Syfer, Eurofarad, Texas Instruments, MS Kennedy, Miteq, Cobham, E2V, MA-COM, Hittite, Mini-Circuits, General Dynamics и др.);

Компания «Океан Электроники» является официальным дистрибьютором и эксклюзивным представителем в России одного из крупнейших производителей разъемов военного и аэрокосмического назначения «JONHON», а так же официальным дистрибьютором и эксклюзивным представителем в России производителя высокотехнологичных и надежных решений для передачи СВЧ сигналов «FORSTAR».



## JONHON

«JONHON» (основан в 1970 г.)

Разъемы специального, военного и аэрокосмического назначения:

(Применяются в военной, авиационной, аэрокосмической, морской, железнодорожной, горно- и нефтедобывающей отраслях промышленности)

«FORSTAR» (основан в 1998 г.)

ВЧ соединители, коаксиальные кабели, кабельные сборки и микроволновые компоненты:

(Применяются в телекоммуникациях гражданского и специального назначения, в средствах связи, РЛС, а так же военной, авиационной и аэрокосмической отраслях промышленности).



Телефон: 8 (812) 309-75-97 (многоканальный)

Факс: 8 (812) 320-03-32

Электронная почта: [ocean@oceanchips.ru](mailto:ocean@oceanchips.ru)

Web: <http://oceanchips.ru/>

Адрес: 198099, г. Санкт-Петербург, ул. Калинина, д. 2, корп. 4, лит. А