

MC74HC1G08

Single 2-Input AND Gate

The MC74HC1G08 is a high speed CMOS 2-input AND gate fabricated with silicon gate CMOS technology.

The internal circuit is composed of multiple stages, including a buffer output which provides high noise immunity and stable output.

The MC74HC1G08 output drive current is 1/2 compared to MC74HC series.

Features

- High Speed: $t_{PD} = 7 \text{ ns}$ (Typ) at $V_{CC} = 5 \text{ V}$
- Low Power Dissipation: $I_{CC} = 1 \text{ }\mu\text{A}$ (Max) at $T_A = 25^\circ\text{C}$
- High Noise Immunity
- Balanced Propagation Delays ($t_{pLH} = t_{pHL}$)
- Symmetrical Output Impedance ($I_{OH} = I_{OL} = 2 \text{ mA}$)
- Chip Complexity: < 100 FETs
- NLV Prefix for Automotive and Other Applications Requiring Unique Site and Control Change Requirements; AEC-Q100 Qualified and PPAP Capable
- These Devices are Pb-Free, Halogen Free/BFR Free and are RoHS Compliant

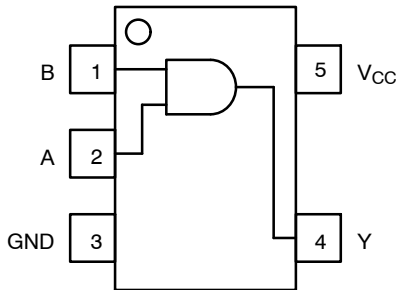

Figure 1. Pinout

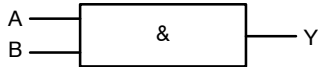

Figure 2. Logic Symbol

PIN ASSIGNMENT	
1	B
2	A
3	GND
4	Y
5	V _{CC}



ON Semiconductor®

www.onsemi.com



SC-88A
DF SUFFIX
CASE 419A

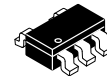

TSOP-5
DT SUFFIX
CASE 483



SC-74A
DBV SUFFIX
CASE 318BQ

MARKING DIAGRAMS

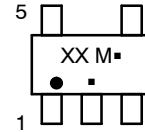
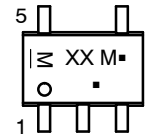

XX = Device Code
M = Date Code*
▪ = Pb-Free Package

(Note: Microdot may be in either location)
*Date Code orientation and/or position may vary depending upon manufacturing location.

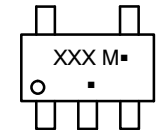

XXX = Specific Device Code
M = Date Code
▪ = Pb-Free Package

(Note: Microdot may be in either location)

FUNCTION TABLE

Inputs		Output
A	B	Y
L	L	L
L	H	L
H	L	L
H	H	H

ORDERING INFORMATION

See detailed ordering, marking and shipping information in the package dimensions section on page 6 of this data

MC74HC1G08

MAXIMUM RATINGS

Symbol	Parameter	Value	Unit
V_{CC}	DC Supply Voltage SC-88A (NLV), TSOP-5 SC-88A, SC-74A	-0.5 to +7.0 -0.5 to +6.5	V
V_{IN}	DC Input Voltage	-0.5 to $V_{CC} + 0.5$	V
V_{OUT}	DC Output Voltage	-0.5 to $V_{CC} + 0.5$	V
I_{IK}	DC Input Diode Current	± 20	mA
I_{OK}	DC Output Diode Current	± 20	mA
I_{OUT}	DC Output Source/Sink Current	± 12.5	mA
I_{CC} or I_{GND}	DC Supply Current per Supply Pin or Ground Pin	± 25	mA
T_{STG}	Storage Temperature Range	-65 to +150	°C
T_L	Lead Temperature, 1 mm from Case for 10 Seconds	260	°C
T_J	Junction Temperature Under Bias	+150	°C
θ_{JA}	Thermal Resistance (Note 1) SC70-5/SC-88A/SOT-353 SOT23-5/TSOP-5/SC59-5 SC-74A	659 555 555	°C/W
P_D	Power Dissipation in Still Air at 85°C SC70-5/SC-88A/SOT-353 SOT23-5/TSOP-5/SC59-5 SC-74A	190 225 225	mW
MSL	Moisture Sensitivity	Level 1	
F_R	Flammability Rating Oxygen Index: 28 to 34	UL 94 V-0 @ 0.125 in	
V_{ESD}	ESD Withstand Voltage (Note 2) Human Body Model Charged Device Model	2000 1000	V
$I_{LATCHUP}$	Latchup Performance (Note 3) SC-88A (NLV), SOT-23 SC-88A, SC-74A	± 500 ± 100	mA

Stresses exceeding those listed in the Maximum Ratings table may damage the device. If any of these limits are exceeded, device functionality should not be assumed, damage may occur and reliability may be affected.

1. Measured with minimum pad spacing on an FR4 board, using 10 mm-by-1 inch, 20 ounce copper trace with no air flow.
2. HBM tested to ANSI/ESDA/JEDEC JS-001-2017. CDM tested to JESD22-C101-F. JEDEC recommends that ESD qualification to EIA/JESD22-A115A (Machine Model) be discontinued per JEDEC/JEP172A.
3. Tested to EIA/JESD78 Class II.

MC74HC1G08

RECOMMENDED OPERATING CONDITIONS

Symbol	Parameter	Min	Max	Unit
V_{CC}	DC Supply Voltage	2.0	6.0	V
V_{IN}	DC Input Voltage	0.0	V_{CC}	V
V_{OUT}	DC Output Voltage	0.0	V_{CC}	V
T_A	Operating Temperature Range	-55	+125	°C
t_r, t_f	Input Rise and Fall Time	SC-88A (NLV), TSOP-5 $V_{CC} = 2.0\text{ V}$ $V_{CC} = 3.0\text{ V}$ $V_{CC} = 4.5\text{ V}$ $V_{CC} = 6.0\text{ V}$		ns/V
		0	1000	
	Input Rise and Fall Time	SC-88A, SC-74A $V_{CC} = 1.65\text{ V to }1.95\text{ V}$ $V_{CC} = 2.3\text{ V to }2.7\text{ V}$ $V_{CC} = 3.0\text{ V to }3.6\text{ V}$ $V_{CC} = 4.5\text{ V to }6.0\text{ V}$		
		0	20	
		0	20	
		0	10	
		0	5	

Functional operation above the stresses listed in the Recommended Operating Ranges is not implied. Extended exposure to stresses beyond the Recommended Operating Ranges limits may affect device reliability.

DC ELECTRICAL CHARACTERISTICS

Symbol	Parameter	Test Conditions	V_{CC} (V)	$T_A = 25^\circ\text{C}$			$-40^\circ\text{C} \leq T_A \leq 85^\circ\text{C}$		$-55^\circ\text{C} \leq T_A \leq 125^\circ\text{C}$		Unit
				Min	Typ	Max	Min	Max	Min	Max	
V_{IH}	High-Level Input Voltage		2.0	1.5	-	-	1.5	-	1.5	-	V
			3.0	2.1	-	-	2.1	-	2.1	-	
			4.5	3.15	-	-	3.15	-	3.15	-	
			6.0	4.20	-	-	4.20	-	4.20	-	
V_{IL}	Low-Level Input Voltage		2.0	-	-	0.5	-	0.5	-	0.5	V
			3.0	-	-	0.9	-	0.9	-	0.9	
			4.5	-	-	1.35	-	1.35	-	1.35	
			6.0	-	-	1.80	-	1.80	-	1.80	
V_{OH}	High-Level Output Voltage	$V_{IN} = V_{IH}$ or V_{IL} $I_{OH} = -20\ \mu\text{A}$	2.0	1.9	2.0	-	1.9	-	1.9	-	V
			3.0	2.9	3.0	-	2.9	-	2.9	-	
			4.5	4.4	4.5	-	4.4	-	4.4	-	
			6.0	5.9	6.0	-	5.9	-	5.9	-	
		$V_{IN} = V_{IH}$ or V_{IL} $I_{OH} = -2\ \text{mA}$ $I_{OH} = -2.6\ \text{mA}$	4.5	4.18	4.31	-	4.13	-	4.08	-	
			6.0	5.68	5.80	-	5.63	-	5.58	-	
V_{OL}	Low-Level Output Voltage	$V_{IN} = V_{IH}$ or V_{IL} $I_{OL} = 20\ \mu\text{A}$	2.0	-	0.0	0.1	-	0.1	-	0.1	V
			3.0	-	0.0	0.1	-	0.1	-	0.1	
			4.5	-	0.0	0.1	-	0.1	-	0.1	
			6.0	-	0.0	0.1	-	0.1	-	0.1	
		$V_{IN} = V_{IH}$ or V_{IL} $I_{OL} = 2\ \text{mA}$ $I_{OL} = 2.6\ \text{mA}$	4.5	-	0.17	0.26	-	0.33	-	0.40	
			6.0	-	0.18	0.26	-	0.33	-	0.40	
I_{IN}	Input Leakage Current	$V_{IN} = 6.0\ \text{V}$ or GND	6.0	-	-	± 0.1 *	-	± 1.0	-	± 1.0	μA
I_{CC}	Quiescent Supply Current	$V_{IN} = V_{CC}$ or GND	6.0	-	-	1.0	-	10	-	40	μA

*Guaranteed by design.

MC74HC1G08

AC ELECTRICAL CHARACTERISTICS (Input $t_r = t_f = 6.0$ ns)

Symbol	Parameter	Test Conditions	$T_A = 25^\circ\text{C}$			$-40^\circ\text{C} \leq T_A \leq 85^\circ\text{C}$		$-55^\circ\text{C} \leq T_A \leq 125^\circ\text{C}$		Unit
			Min	Typ	Max	Min	Max	Min	Max	
t_{PLH} , t_{PHL}	Propagation Delay, Input A or B to \bar{Y}	$V_{CC} = 5.0\text{ V}$ $C_L = 15\text{ pF}$	-	3.5	15	-	20	-	25	ns
		$V_{CC} = 2.0\text{ V}$ $C_L = 50\text{ pF}$	-	20	100	-	125	-	155	
		$V_{CC} = 3.0\text{ V}$	-	11	27	-	35	-	90	
		$V_{CC} = 4.5\text{ V}$ $V_{CC} = 6.0\text{ V}$	-	8 7	20 17	-	25 21	-	35 26	
t_{TLH} , t_{THL}	Output Transition Time	$V_{CC} = 5.0\text{ V}$ $C_L = 15\text{ pF}$	-	3	10	-	15	-	20	ns
		$V_{CC} = 2.0\text{ V}$ $C_L = 50\text{ pF}$	-	25	125	-	155	-	200	
		$V_{CC} = 3.0\text{ V}$	-	16	35	-	45	-	60	
		$V_{CC} = 4.5\text{ V}$ $V_{CC} = 6.0\text{ V}$	-	11 9	25 21	-	31 26	-	38 32	
C_{IN}	Input Capacitance		-	5	10	-	10	-	10	pF
C_{PD}	Power Dissipation Capacitance (Note 4)	Typical @ 25°C, $V_{CC} = 5.0\text{ V}$							pF	
		10								

4. C_{PD} is defined as the value of the internal equivalent capacitance which is calculated from the operating current consumption without load. Average operating current can be obtained by the equation: $I_{CC(OPR)} = C_{PD} \cdot V_{CC} \cdot f_{in} + I_{CC}$. C_{PD} is used to determine the no-load dynamic power consumption; $P_D = C_{PD} \cdot V_{CC}^2 \cdot f_{in} + I_{CC} \cdot V_{CC}$.

MC74HC1G08



* C_L includes probe and jig capacitance
 R_T is Z_{OUT} of pulse generator (typically 50 Ω)
 $f = 1$ MHz

Figure 3. Test Circuit

Test	Switch Position	C_L , pF	R_L , Ω
t_{PLH} / t_{PHL}	Open	See AC Characteristics Table	X
t_{TLH} / t_{THL} (Note 5)	Open		X
t_{PLZ} / t_{PZL}	V_{CC}		1 k
t_{PHZ} / t_{PZH}	GND		1 k

X - Don't Care

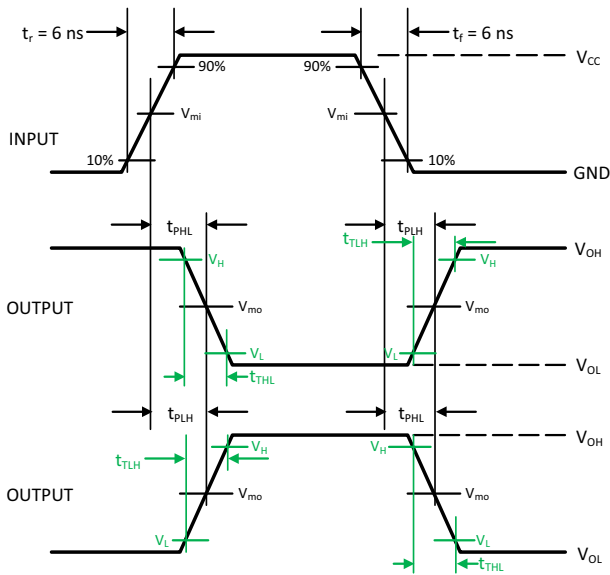

Figure 4. Switching Waveforms

V_{CC} , V	V_{mi} , V	V_{mo} , V		V_L , V	V_H , V	V_Y , V
		t_{PLH} , t_{PHL}	t_{PZL} , t_{PLZ} , t_{PZH} , t_{PHZ}			
3.0 to 3.6	$V_{CC}/2$	$(V_{OH} - V_{OL})/2$	$V_{CC}/2$	$V_{OL} + 0.1 (V_{OH} - V_{OL})$	$V_{OL} + 0.9 (V_{OH} - V_{OL})$	0.3
4.5 to 5.5	$V_{CC}/2$	$(V_{OH} - V_{OL})/2$	$V_{CC}/2$	$V_{OL} + 0.1 (V_{OH} - V_{OL})$	$V_{OL} + 0.9 (V_{OH} - V_{OL})$	0.3

5. t_{TLH} and t_{THL} are measured from 10% to 90% of $(V_{OH} - V_{OL})$, and 90% to 10% of $(V_{OH} - V_{OL})$, respectively.

MC74HC1G08

ORDERING INFORMATION

Device	Packages	Specific Device Code	Pin 1 Orientation (See below)	Shipping†
MC74HC1G08DFT1G	SC-88A	H2	Q2	3000 / Tape & Reel
NLVHC1G08DFT1G*	SC-88A	H2	Q2	3000 / Tape & Reel
MC74HC1G08DFT2G	SC-88A	H2	Q4	3000 / Tape & Reel
NLVHC1G08DFT2G*	SC-88A	H2	Q4	3000 / Tape & Reel
MC74HC1G08DTT1G	TSOP-5	H2	Q4	3000 / Tape & Reel
NLVHC1G08DTT1G*	TSOP-5	H2R	Q4	3000 / Tape & Reel
MC74HC1G08DBVT1G (In Development)	SC-74A	TBD	Q4	3000 / Tape & Reel

†For complete information on tape and reel specifications, including part orientation and tape sizes, please refer to our Tape and Reel Packaging Specifications Brochure, BRD8011/D.

*NLV Prefix for Automotive and Other Applications Requiring Unique Site and Control Change Requirements; AEC-Q100 Qualified and PPAP Capable.

Pin 1 Orientation in Tape and Reel

Direction of Feed

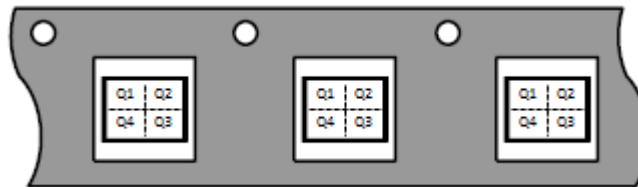

MC74HC1G08

PACKAGE DIMENSIONS

SC-88A (SC-70-5/SOT-353)
CASE 419A-02
ISSUE L

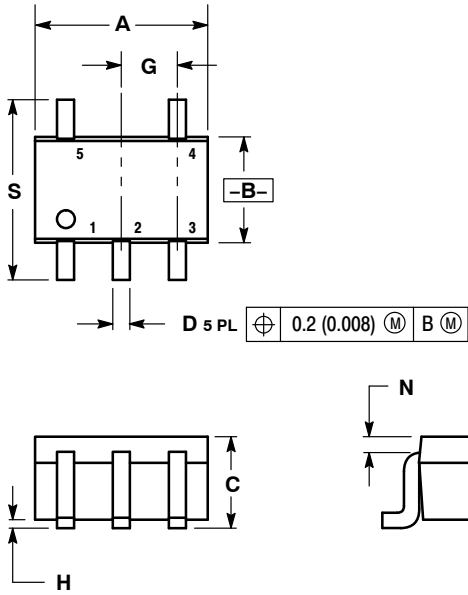

- NOTES:
1. DIMENSIONING AND TOLERANCING PER ANSI Y14.5M, 1982.
 2. CONTROLLING DIMENSION: INCH.
 3. 419A-01 OBSOLETE. NEW STANDARD 419A-02.
 4. DIMENSIONS A AND B DO NOT INCLUDE MOLD FLASH, PROTRUSIONS, OR GATE BURRS.

DIM	INCHES		MILLIMETERS	
	MIN	MAX	MIN	MAX
A	0.071	0.087	1.80	2.20
B	0.045	0.053	1.15	1.35
C	0.031	0.043	0.80	1.10
D	0.004	0.012	0.10	0.30
G	0.026 BSC		0.65 BSC	
H	---	0.004	---	0.10
J	0.004	0.010	0.10	0.25
K	0.004	0.012	0.10	0.30
N	0.008 REF		0.20 REF	
S	0.079	0.087	2.00	2.20

SOLDER FOOTPRINT

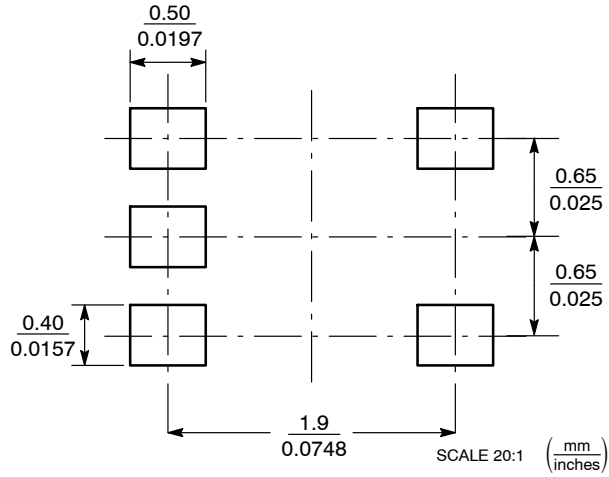

MC74HC1G08

PACKAGE DIMENSIONS

TSOP-5
CASE 483
ISSUE M

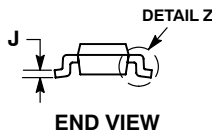
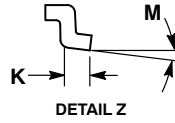
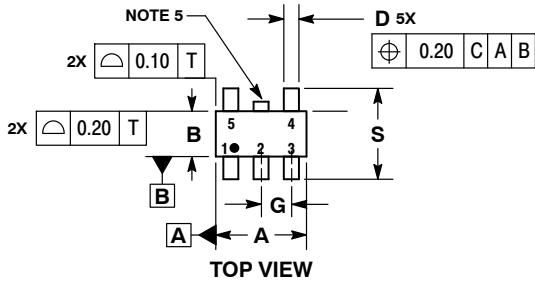

NOTES:

1. DIMENSIONING AND TOLERANCING PER ASME Y14.5M, 1994.
2. CONTROLLING DIMENSION: MILLIMETERS.
3. MAXIMUM LEAD THICKNESS INCLUDES LEAD FINISH THICKNESS. MINIMUM LEAD THICKNESS IS THE MINIMUM THICKNESS OF BASE MATERIAL.
4. DIMENSIONS A AND B DO NOT INCLUDE MOLD FLASH, PROTRUSIONS, OR GATE BURRS. MOLD FLASH, PROTRUSIONS, OR GATE BURRS SHALL NOT EXCEED 0.15 PER SIDE. DIMENSION A.
5. OPTIONAL CONSTRUCTION: AN ADDITIONAL TRIMMED LEAD IS ALLOWED IN THIS LOCATION. TRIMMED LEAD NOT TO EXTEND MORE THAN 0.2 FROM BODY.

DIM	MILLIMETERS	
	MIN	MAX
A	2.85	3.15
B	1.35	1.65
C	0.90	1.10
D	0.25	0.50
G	0.95 BSC	
H	0.01	0.10
J	0.10	0.26
K	0.20	0.60
M	0° 10°	
S	2.50	3.00

SOLDERING FOOTPRINT*

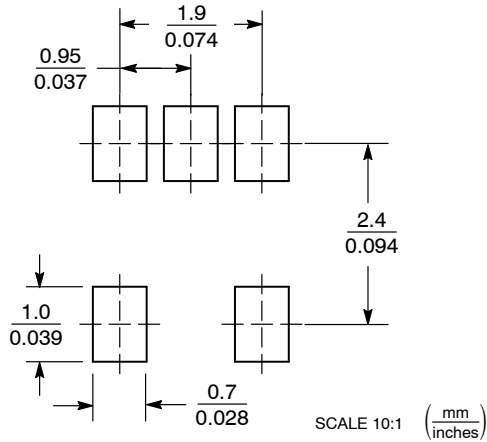

*For additional information on our Pb-Free strategy and soldering details, please download the ON Semiconductor Soldering and Mounting Techniques Reference Manual, SOLDERRM/D.

MC74HC1G08

PACKAGE DIMENSIONS

SC-74A CASE 318BQ ISSUE B



TOP VIEW



SIDE VIEW

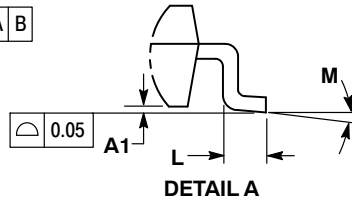

DETAIL A

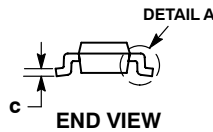

END VIEW

NOTES:

1. DIMENSIONING AND TOLERANCING PER ASME Y14.5M, 1994.
2. CONTROLLING DIMENSION: MILLIMETERS.
3. MAXIMUM LEAD THICKNESS INCLUDES LEAD FINISH THICKNESS. MINIMUM LEAD THICKNESS IS THE MINIMUM THICKNESS OF BASE MATERIAL.
4. DIMENSIONS A AND B DO NOT INCLUDE MOLD FLASH, PROTRUSIONS, OR GATE BURRS. MOLD FLASH, PROTRUSIONS, OR GATE BURRS SHALL NOT EXCEED 0.15 PER SIDE.

DIM	MILLIMETERS	
	MIN	MAX
A	0.90	1.10
A1	0.01	0.10
b	0.25	0.50
c	0.10	0.26
D	2.85	3.15
E	2.50	3.00
E1	1.35	1.65
e	0.95 BSC	
L	0.20	0.60
M	0° 10°	

RECOMMENDED SOLDERING FOOTPRINT*

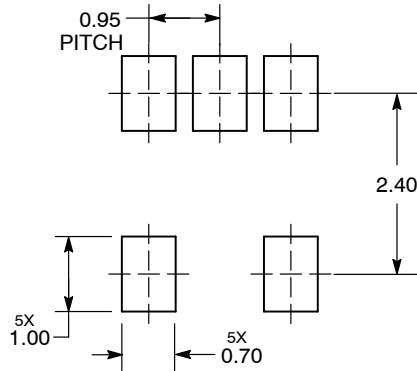

DIMENSIONS: MILLIMETERS

*For additional information on our Pb-Free strategy and soldering details, please download the ON Semiconductor Soldering and Mounting Techniques Reference Manual, SOLDERRM/D.

ON Semiconductor and are trademarks of Semiconductor Components Industries, LLC dba ON Semiconductor or its subsidiaries in the United States and/or other countries. ON Semiconductor owns the rights to a number of patents, trademarks, copyrights, trade secrets, and other intellectual property. A listing of ON Semiconductor's product/patent coverage may be accessed at www.onsemi.com/site/pdf/Patent-Marking.pdf. ON Semiconductor reserves the right to make changes without further notice to any products herein. ON Semiconductor makes no warranty, representation or guarantee regarding the suitability of its products for any particular purpose, nor does ON Semiconductor assume any liability arising out of the application or use of any product or circuit, and specifically disclaims any and all liability, including without limitation special, consequential or incidental damages. Buyer is responsible for its products and applications using ON Semiconductor products, including compliance with all laws, regulations and safety requirements or standards, regardless of any support or applications information provided by ON Semiconductor. "Typical" parameters which may be provided in ON Semiconductor data sheets and/or specifications can and do vary in different applications and actual performance may vary over time. All operating parameters, including "Typicals" must be validated for each customer application by customer's technical experts. ON Semiconductor does not convey any license under its patent rights nor the rights of others. ON Semiconductor products are not designed, intended, or authorized for use as a critical component in life support systems or any FDA Class 3 medical devices or medical devices with a same or similar classification in a foreign jurisdiction or any devices intended for implantation in the human body. Should Buyer purchase or use ON Semiconductor products for any such unintended or unauthorized application, Buyer shall indemnify and hold ON Semiconductor and its officers, employees, subsidiaries, affiliates, and distributors harmless against all claims, costs, damages, and expenses, and reasonable attorney fees arising out of, directly or indirectly, any claim of personal injury or death associated with such unintended or unauthorized use, even if such claim alleges that ON Semiconductor was negligent regarding the design or manufacture of the part. ON Semiconductor is an Equal Opportunity/Affirmative Action Employer. This literature is subject to all applicable copyright laws and is not for resale in any manner.

PUBLICATION ORDERING INFORMATION

LITERATURE FULFILLMENT:

Literature Distribution Center for ON Semiconductor
19521 E. 32nd Pkwy, Aurora, Colorado 80011 USA
Phone: 303-675-2175 or 800-344-3860 Toll Free USA/Canada
Fax: 303-675-2176 or 800-344-3867 Toll Free USA/Canada
Email: orderlit@onsemi.com

N. American Technical Support: 800-282-9855 Toll Free
USA/Canada
Europe, Middle East and Africa Technical Support:
Phone: 421 33 790 2910

ON Semiconductor Website: www.onsemi.com

Order Literature: <http://www.onsemi.com/orderlit>

For additional information, please contact your local Sales Representative

Компания «Океан Электроники» предлагает заключение долгосрочных отношений при поставках импортных электронных компонентов на взаимовыгодных условиях!

Наши преимущества:

- Поставка оригинальных импортных электронных компонентов напрямую с производств Америки, Европы и Азии, а так же с крупнейших складов мира;
- Широкая линейка поставок активных и пассивных импортных электронных компонентов (более 30 млн. наименований);
- Поставка сложных, дефицитных, либо снятых с производства позиций;
- Оперативные сроки поставки под заказ (от 5 рабочих дней);
- Экспресс доставка в любую точку России;
- Помощь Конструкторского Отдела и консультации квалифицированных инженеров;
- Техническая поддержка проекта, помощь в подборе аналогов, поставка прототипов;
- Поставка электронных компонентов под контролем ВП;
- Система менеджмента качества сертифицирована по Международному стандарту ISO 9001;
- При необходимости вся продукция военного и аэрокосмического назначения проходит испытания и сертификацию в лаборатории (по согласованию с заказчиком);
- Поставка специализированных компонентов военного и аэрокосмического уровня качества (Xilinx, Altera, Analog Devices, Intersil, Interpoint, Microsemi, Actel, Aeroflex, Peregrine, VPT, Syfer, Eurofarad, Texas Instruments, MS Kennedy, Miteq, Cobham, E2V, MA-COM, Hittite, Mini-Circuits, General Dynamics и др.);

Компания «Океан Электроники» является официальным дистрибьютором и эксклюзивным представителем в России одного из крупнейших производителей разъемов военного и аэрокосмического назначения «JONHON», а так же официальным дистрибьютором и эксклюзивным представителем в России производителя высокотехнологичных и надежных решений для передачи СВЧ сигналов «FORSTAR».



JONHON

«JONHON» (основан в 1970 г.)

Разъемы специального, военного и аэрокосмического назначения:

(Применяются в военной, авиационной, аэрокосмической, морской, железнодорожной, горно- и нефтедобывающей отраслях промышленности)

«FORSTAR» (основан в 1998 г.)

ВЧ соединители, коаксиальные кабели, кабельные сборки и микроволновые компоненты:

(Применяются в телекоммуникациях гражданского и специального назначения, в средствах связи, РЛС, а так же военной, авиационной и аэрокосмической отраслях промышленности).



Телефон: 8 (812) 309-75-97 (многоканальный)

Факс: 8 (812) 320-03-32

Электронная почта: ocean@oceanchips.ru

Web: <http://oceanchips.ru/>

Адрес: 198099, г. Санкт-Петербург, ул. Калинина, д. 2, корп. 4, лит. А