

## STRADA-2X2-PXL

Fully asymmetric beam designed to highlight pedestrian crossings for left side traffic

### TECHNICAL SPECIFICATIONS:

Dimensions	50.0 mm
Height	8 mm
Fastening	pin, screw
ROHS compliant	yes ⓘ

### MATERIAL SPECIFICATIONS:

Component	Type	Material	Colour	Finish
STRADA-2X2-PXL	Multi-lens	PMMA	clear	



### ORDERING INFORMATION:

Component	Qty in box	MOQ	MPQ	Box weight (kg)
C14896_STRADA-2X2-PXL » Box size: 480 x 280 x 300 mm	800	160	160	7.9

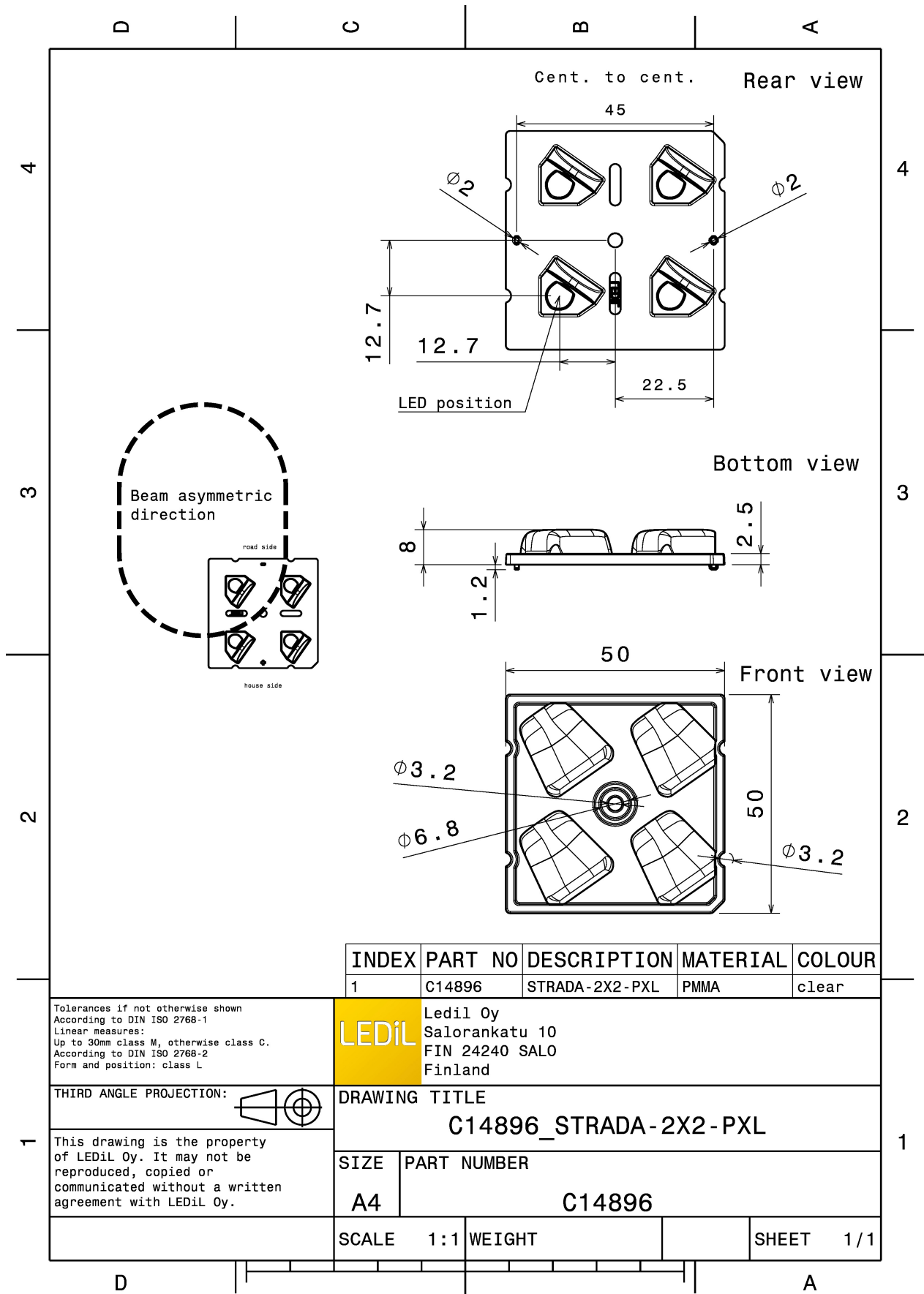

#### PHOTOMETRIC DATA (MEASURED):



LED XD16  
 FWHM Asymmetric  
 Efficiency 94 %  
 Peak intensity 1.2 cd/lm  
 LEDs/each optic 1  
 Light colour White  
 Required components:

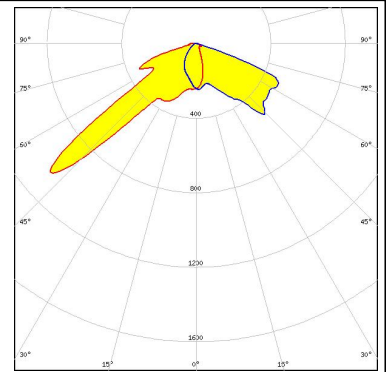

LED LUXEON 5050 Round LES  
 FWHM Asymmetric  
 Efficiency 94 %  
 Peak intensity 0.8 cd/lm  
 LEDs/each optic 1  
 Light colour White  
 Required components:

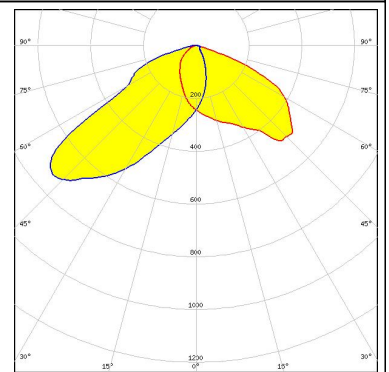

LED LUXEON MZ  
 FWHM Asymmetric  
 Efficiency 94 %  
 Peak intensity 0.9 cd/lm  
 LEDs/each optic 1  
 Light colour White  
 Required components:

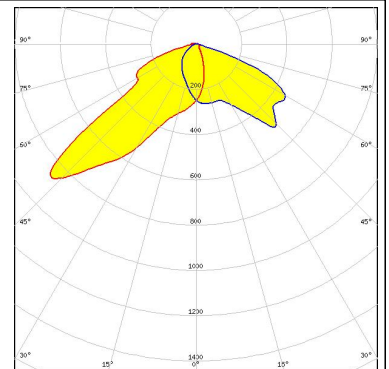

LED LUXEON V  
 FWHM Asymmetric  
 Efficiency 94 %  
 Peak intensity 0.8 cd/lm  
 LEDs/each optic 1  
 Light colour White  
 Required components:

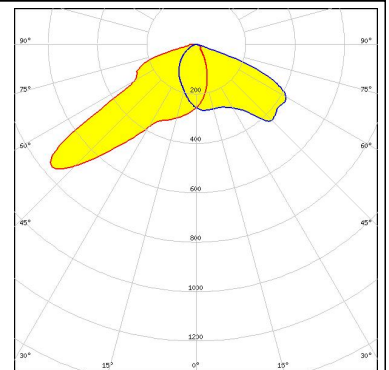
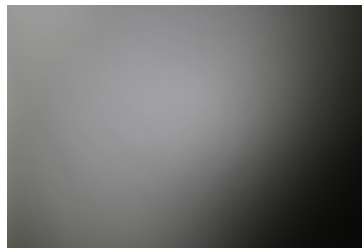

#### PHOTOMETRIC DATA (MEASURED):



**LED** NVSW219F  
**FWHM** Asymmetric  
**Efficiency** 94 %  
**Peak intensity** 0.9 cd/lm  
**LEDs/each optic** 1  
**Light colour** White  
**Required components:**

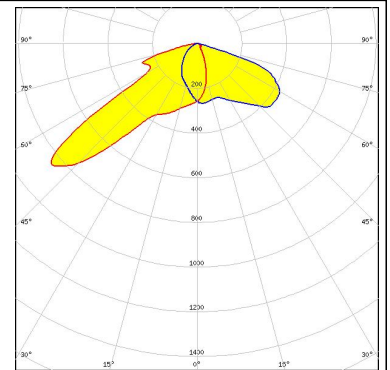

**LED** NVSW319B  
**FWHM** Asymmetric  
**Efficiency** 94 %  
**Peak intensity** 0.9 cd/lm  
**LEDs/each optic** 1  
**Light colour** White  
**Required components:**

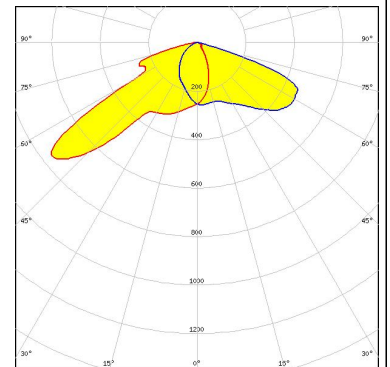

**LED** NVSxE21A  
**FWHM** Asymmetric  
**Efficiency** 94 %  
**Peak intensity** 1.4 cd/lm  
**LEDs/each optic** 1  
**Light colour** White  
**Required components:**

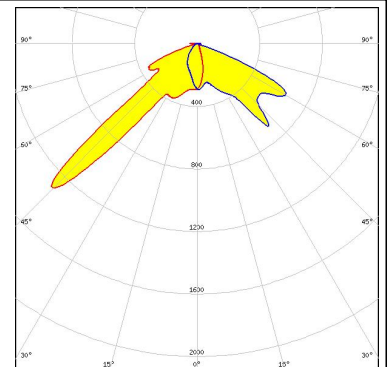

**LED** OSLOM Square PC  
**FWHM** Asymmetric  
**Efficiency** 94 %  
**Peak intensity** 1.1 cd/lm  
**LEDs/each optic** 1  
**Light colour** White  
**Required components:**

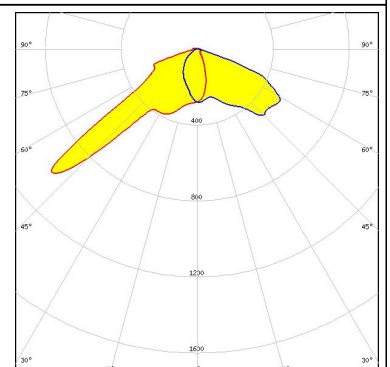

#### PHOTOMETRIC DATA (MEASURED):

#### SAMSUNG

LED HiLOM RH16 (LH351C)  
 FWHM Asymmetric  
 Efficiency 94 %  
 Peak intensity 1 cd/lm  
 LEDs/each optic 1  
 Light colour White  
 Required components:

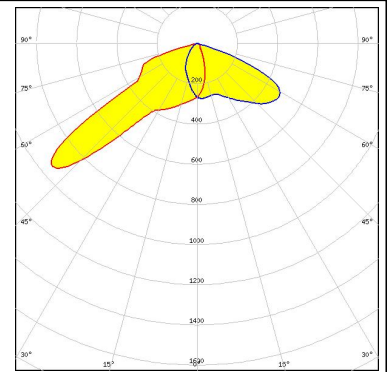

#### SAMSUNG

LED LH351B  
 FWHM Asymmetric  
 Efficiency 94 %  
 Peak intensity 0.9 cd/lm  
 LEDs/each optic 1  
 Light colour White  
 Required components:

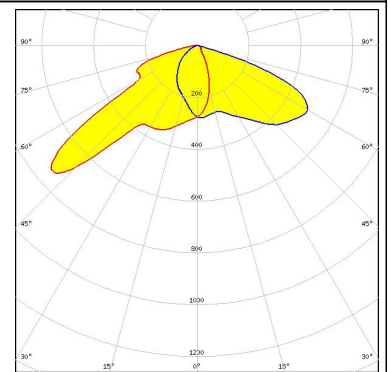

SEOUL SEMICONDUCTOR

LED Z5M3  
 FWHM Asymmetric  
 Efficiency 94 %  
 Peak intensity 0.9 cd/lm  
 LEDs/each optic 1  
 Light colour White  
 Required components:

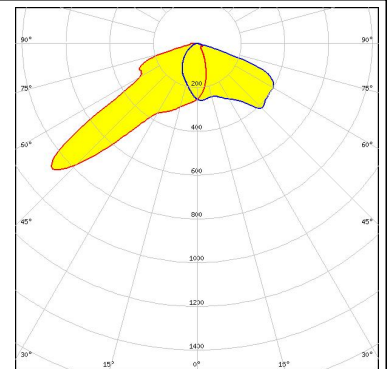

SEOUL SEMICONDUCTOR

LED Z8Y22  
 FWHM Asymmetric  
 Efficiency 94 %  
 Peak intensity 1 cd/lm  
 LEDs/each optic 1  
 Light colour White  
 Required components:

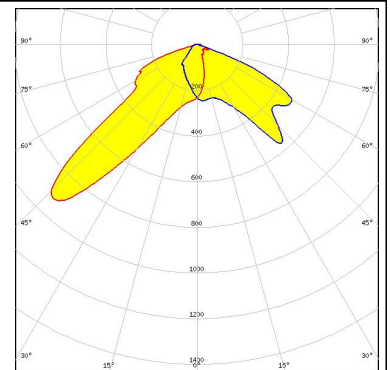
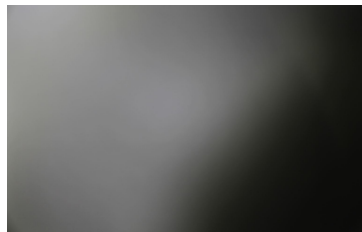

#### PHOTOMETRIC DATA (MEASURED):

#### TRIDONIC

LED RLE 2x4 2000lm HP EXC2 OTD  
FWHM Asymmetric  
Efficiency 94 %  
Peak intensity 1.2 cd/lm  
LEDs/each optic 1  
Light colour White  
Required components:

#### TRIDONIC

LED RLE 2x8 4000lm HP EXC2 OTD  
FWHM Asymmetric  
Efficiency 94 %  
Peak intensity 1.2 cd/lm  
LEDs/each optic 1  
Light colour White  
Required components:

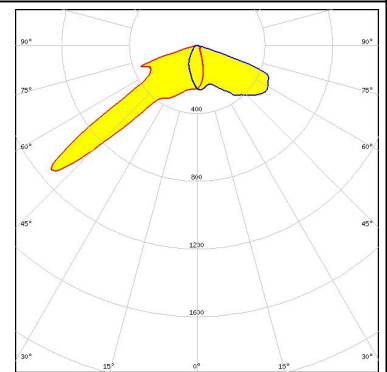

#### PHOTOMETRIC DATA (SIMULATED):



LED XP-G2  
 FWHM Asymmetric  
 Efficiency 95 %  
 Peak intensity 1.1 cd/lm  
 LEDs/each optic 1  
 Light colour White  
 Required components:

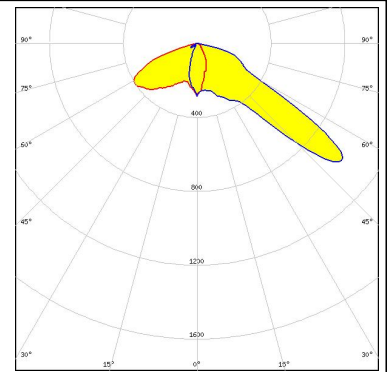

LED XP-G2 HE  
 FWHM Asymmetric  
 Efficiency 95 %  
 Peak intensity 0.9 cd/lm  
 LEDs/each optic 1  
 Light colour White  
 Required components:

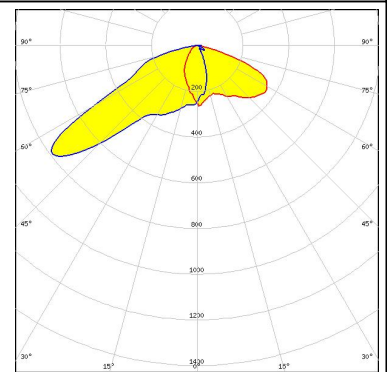

LED XP-G3  
 FWHM Asymmetric  
 Efficiency 81 %  
 Peak intensity 0.8 cd/lm  
 LEDs/each optic 1  
 Light colour White  
 Required components:

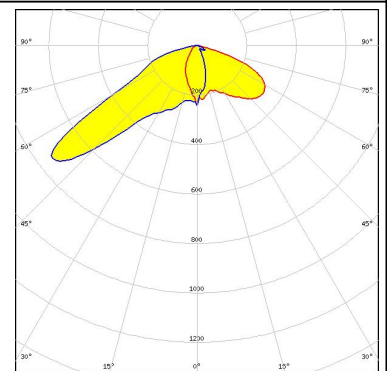

Transparent protective cover



LED LUXEON TX  
 FWHM Asymmetric  
 Efficiency 95 %  
 Peak intensity 1.1 cd/lm  
 LEDs/each optic 1  
 Light colour White  
 Required components:

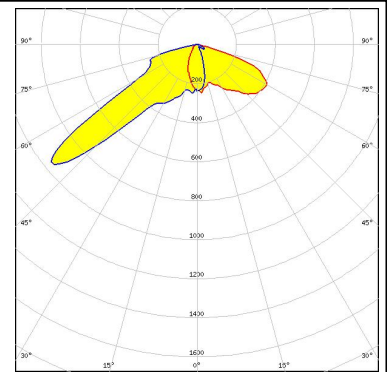

#### PHOTOMETRIC DATA (SIMULATED):

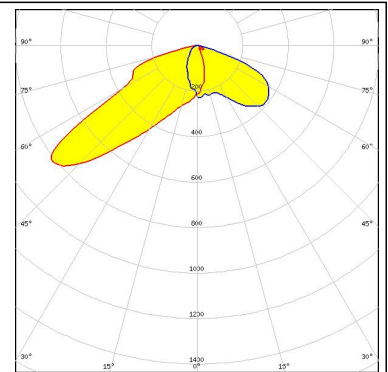
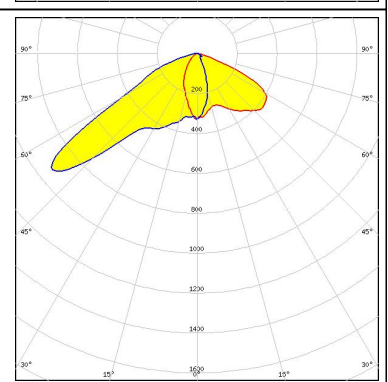
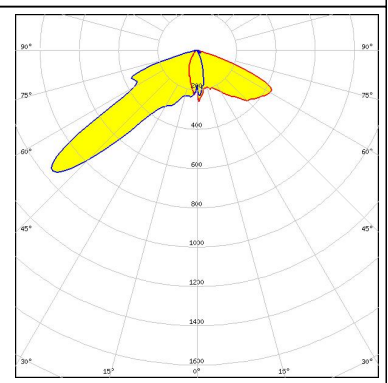
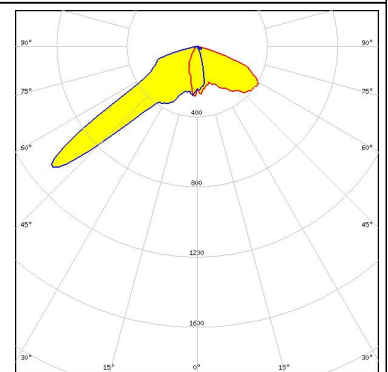
<p><b>NICHIA</b></p> <p>LED: NV4WB35AM            FWHM: Asymmetric            Efficiency: 96 %            Peak intensity: 0.9 cd/lm            LEDs/each optic: 1            Light colour: White            Required components:</p>	
<p><b>NICHIA</b></p> <p>LED: NVSW219D            FWHM: Asymmetric            Efficiency: 94 %            Peak intensity: 1.1 cd/lm            LEDs/each optic: 1            Light colour: White            Required components:</p> <p>Transparent protective cover</p>	
<p><b>NICHIA</b></p> <p>LED: NVSxx19B/NVSxx19C            FWHM: Asymmetric            Efficiency: 92 %            Peak intensity: 1 cd/lm            LEDs/each optic: 1            Light colour: White            Required components:</p>	
<p><b>OSRAM</b></p> <p>LED: PrevaLED Brick HP 2x8            FWHM: Asymmetric            Efficiency: 93 %            Peak intensity: 1.2 cd/lm            LEDs/each optic: 1            Light colour: White            Required components:</p>	



#### PHOTOMETRIC DATA (SIMULATED):

##### OSRAM Opto Semiconductors

LED Duris S8  
FWHM Asymmetric  
Efficiency 94 %  
Peak intensity 0.8 cd/lm  
LEDs/each optic 1  
Light colour White  
Required components:

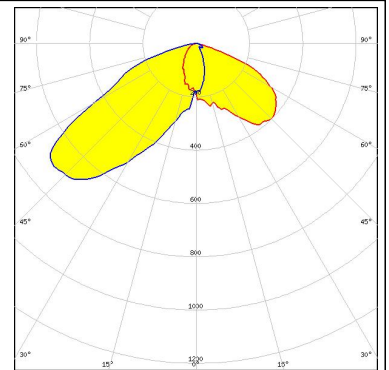

##### OSRAM Opto Semiconductors

LED OSLOM Square CSSRM2/CSSRM3  
FWHM Asymmetric  
Efficiency 93 %  
Peak intensity 1.2 cd/lm  
LEDs/each optic 1  
Light colour White  
Required components:

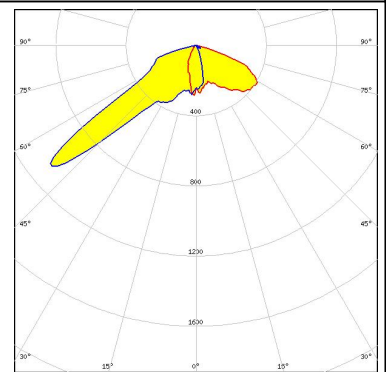

#### GENERAL INFORMATION:

NOTE: The typical beam angle will be changed by different color, chip size and chip position tolerance. The typical total beam angle is the full angle measured where the luminous intensity is half of the peak value.

#### MATERIALS:

As part of our continuous research and improvement processes, and to ensure the best possible quality and availability of our products, LEDiL reserves the right to change material grades without notice.

#### PRODUCT DATA USER AGREEMENT AND DISCLAIMER:

The measured data in the provided downloadable LEDiL Product Datasheets and Mechanical 2D-Drawings is rounded and provided as reference for planning. LEDiL Oy's optical specifications have been verified by conducting performance testing of the products in accordance with the company's quality system. The reported data are averaged results of multiple measurements with typical variation. LEDiL Oy reserves the right to without prior notification make changes and improvements to its products.

LEDiL Oy assumes neither warranty, nor guarantee nor any other liability of any kind for the contents and correctness of the provided data. The provided data has been generated with highest diligence but the provided data may in reality not represent the complete possible variation range of all intrinsic parameters. Therefore, in certain cases a deviation from the provided data could occur.

LEDiL Oy reserves the right to undertake technical changes of its products without further notification which could lead to changes in the provided data. LEDiL Oy assumes no liability of any kind for the possible deviation from any provided data or any other damage resulting from the usage of the provided data.

The user agrees to this disclaimer and user agreement with the download or usage of the provided files.

#### LEDiL Oy

Joensuunkatu 13  
FI-24240 SALO  
Finland

#### LEDiL Inc.

228 West Page Street  
Suite D  
Sycamore IL 60178  
USA

#### Local sales and technical support

[www.ledil.com/  
where\\_to\\_buy](http://www.ledil.com/where_to_buy)

#### Shipping locations

Salo, Finland  
Hong Kong, China

#### Distribution Partners

[www.ledil.com/  
where\\_to\\_buy](http://www.ledil.com/where_to_buy)

Компания «Океан Электроники» предлагает заключение долгосрочных отношений при поставках импортных электронных компонентов на взаимовыгодных условиях!

Наши преимущества:

- Поставка оригинальных импортных электронных компонентов напрямую с производств Америки, Европы и Азии, а так же с крупнейших складов мира;
- Широкая линейка поставок активных и пассивных импортных электронных компонентов (более 30 млн. наименований);
- Поставка сложных, дефицитных, либо снятых с производства позиций;
- Оперативные сроки поставки под заказ (от 5 рабочих дней);
- Экспресс доставка в любую точку России;
- Помощь Конструкторского Отдела и консультации квалифицированных инженеров;
- Техническая поддержка проекта, помощь в подборе аналогов, поставка прототипов;
- Поставка электронных компонентов под контролем ВП;
- Система менеджмента качества сертифицирована по Международному стандарту ISO 9001;
- При необходимости вся продукция военного и аэрокосмического назначения проходит испытания и сертификацию в лаборатории (по согласованию с заказчиком);
- Поставка специализированных компонентов военного и аэрокосмического уровня качества (Xilinx, Altera, Analog Devices, Intersil, Interpoint, Microsemi, Actel, Aeroflex, Peregrine, VPT, Syfer, Eurofarad, Texas Instruments, MS Kennedy, Miteq, Cobham, E2V, MA-COM, Hittite, Mini-Circuits, General Dynamics и др.);

Компания «Океан Электроники» является официальным дистрибьютором и эксклюзивным представителем в России одного из крупнейших производителей разъемов военного и аэрокосмического назначения «JONHON», а так же официальным дистрибьютором и эксклюзивным представителем в России производителя высокотехнологичных и надежных решений для передачи СВЧ сигналов «FORSTAR».



## JONHON

«JONHON» (основан в 1970 г.)

Разъемы специального, военного и аэрокосмического назначения:

(Применяются в военной, авиационной, аэрокосмической, морской, железнодорожной, горно- и нефтедобывающей отраслях промышленности)

«FORSTAR» (основан в 1998 г.)

ВЧ соединители, коаксиальные кабели,  
кабельные сборки и микроволновые компоненты:

(Применяются в телекоммуникациях гражданского и специального назначения, в средствах связи, РЛС, а так же военной, авиационной и аэрокосмической отраслях промышленности).



Телефон: 8 (812) 309-75-97 (многоканальный)

Факс: 8 (812) 320-03-32

Электронная почта: [ocean@oceanchips.ru](mailto:ocean@oceanchips.ru)

Web: <http://oceanchips.ru/>

Адрес: 198099, г. Санкт-Петербург, ул. Калинина, д. 2, корп. 4, лит. А