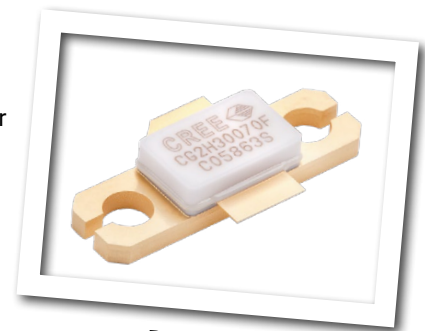


CG2H30070F

70 W, 0.5–3.0 GHz, 28 V, RF Power GaN HEMT

Cree's CG2H30070F is an internally matched gallium nitride (GaN) high electron mobility transistor (HEMT). The CG2H30070F, operating from a 28 volt rail, offers a general purpose, broadband solution to a variety of RF and microwave applications. GaN HEMTs offer high efficiency, high gain and wide bandwidth capabilities making the CG2H30070F ideal for linear and compressed amplifier circuits. The transistor is available in a flange package.



Package Type: 440224
PN: CG2H30070F

Typical Performance Over 0.5 - 3.0 GHz ($T_c = 25^\circ\text{C}$)

Parameter	500 MHz	1000 MHz	1500 MHz	2000 MHz	2500 MHz	3000 MHz	Units
Small Signal Gain (S21)	16.7	15.3	17.3	15	16.3	14.8	dB
Gain @ $P_{in} = 39\text{ dBm}$	10.3	10.4	10.6	9.8	11.4	10.5	dB
Output Power @ $P_{in} = 39\text{ dBm}$	85	88	90	76	109	89	W
Efficiency @ $P_{in} = 39\text{ dBm}$	63	57.5	55.6	63.4	62.1	59.8	%

Note: Operating conditions are CW

Features

- 0.5 - 3.0 GHz Operation
- 85 W P_{OUT} typical at 28 V
- 10 dB Power Gain
- 58 % Drain Efficiency
- Internally Matched

Applications

- Broadband Amplifiers
- Electronic Counter Measures
- Signal Jamming
- Milcom
- Radar
- Data Link

Large Signal Models Available for ADS and MWO



Absolute Maximum Ratings (not simultaneous) at 25°C Case Temperature

Parameter	Symbol	Rating	Units	Conditions
Drain-Source Voltage	V_{DS}	120	Volts	25°C
Gate-to-Source Voltage	V_{GS}	-10, +2	Volts	25°C
Storage Temperature	T_{STG}	-65, +150	°C	
Operating Junction Temperature	T_J	225	°C	
Maximum Forward Gate Current	I_{GMAX}	28.8	mA	25°C
Maximum Drain Current ¹	I_{DMAX}	12	A	25°C
Soldering Temperature ²	T_S	245	°C	
Screw Torque	τ	40	in-oz	
Thermal Resistance, Junction to Case ³	$R_{\theta JC}$	1.5	°C/W	85°C, CW, $P_{DISS} = 115 \text{ W}$
Case Operating Temperature ²	T_C	-40, +150	°C	

Note:

¹ Current limit for long term, reliable operation

² Refer to the Application Note on soldering at www.cree.com/RF/Document-Library

³ See also, the Power Dissipation De-rating Curve on Page 8.

Electrical Characteristics ($T_C = 25^\circ\text{C}$)

Characteristics	Symbol	Min.	Typ.	Max.	Units	Conditions
DC Characteristics¹						
Gate Threshold Voltage	$V_{GS(th)}$	-3.8	-2.8	-2.3	V_{DC}	$V_{DS} = 10 \text{ V}, I_D = 28.8 \text{ mA}$
Saturated Drain Current ²	I_{DS}	23	28.8	-	A	$V_{DS} = 6.0 \text{ V}, V_{GS} = 2.0 \text{ V}$
Drain-Source Breakdown Voltage	V_{BR}	120	-	-	V_{DC}	$V_{GS} = -8 \text{ V}, I_D = 28.8 \text{ mA}$
RF Characteristics³ ($T_C = 25^\circ\text{C}$, $F_0 = 3000 \text{ MHz}$ unless otherwise noted)						
Small Signal Gain	G_{SS}	15.6	17.7	-	dB	$V_{DD} = 28 \text{ V}, I_{DQ} = 1.0 \text{ A}, P_{IN} = 10 \text{ dBm}, \text{CW}$
Power Gain	G_P	-	12	-	dB	$V_{DD} = 28 \text{ V}, I_{DQ} = 1.0 \text{ A}, P_{IN} = 38 \text{ dBm}, \text{CW}$
Output Power	P_{OUT}	48.25	50	-	dBm	$V_{DD} = 28 \text{ V}, I_{DQ} = 1.0 \text{ A}, P_{IN} = 38 \text{ dBm}, \text{CW}$
Drain Efficiency ⁴	η	61	71	-		$V_{DD} = 28 \text{ V}, I_{DQ} = 1.0 \text{ A}, P_{IN} = 38 \text{ dBm}, \text{CW}$
Output Mismatch Stress	VSWR	-	-	5 : 1	Ψ	No damage at all phase angles, $V_{DD} = 28 \text{ V}, I_{DQ} = 1.0 \text{ A}, P_{OUT} = 100 \text{ W CW}$
Dynamic Characteristics						
Input Capacitance	C_{GS}	-	68.1	-	pF	$V_{DS} = 28 \text{ V}, V_{gs} = -8 \text{ V}, f = 1 \text{ MHz}$
Output Capacitance	C_{DS}	-	11.3	-	pF	$V_{DS} = 28 \text{ V}, V_{gs} = -8 \text{ V}, f = 1 \text{ MHz}$
Feedback Capacitance	C_{GD}	-	1.49	-	pF	$V_{DS} = 28 \text{ V}, V_{gs} = -8 \text{ V}, f = 1 \text{ MHz}$

Notes:

¹ Measured on wafer prior to packaging per side of device.

² Scaled from PCM data.

³ Measurements are to be performed using Cree production test fixture AD-838279F-TB (Flange)

⁴ Drain Efficiency = P_{OUT} / P_{DC}

⁵ Capacitance values are for each side of the device.

CG2H30070F Typical Performance

Figure 1 - Small Signal Gain and Return Losses of the CG2H30070F vs Frequency as Measured in the Single-ended Demonstration Amplifier CG2H30070F-AMP
 $V_{DD} = 28\text{ V}, I_{DQ} = 1.0\text{ A}$

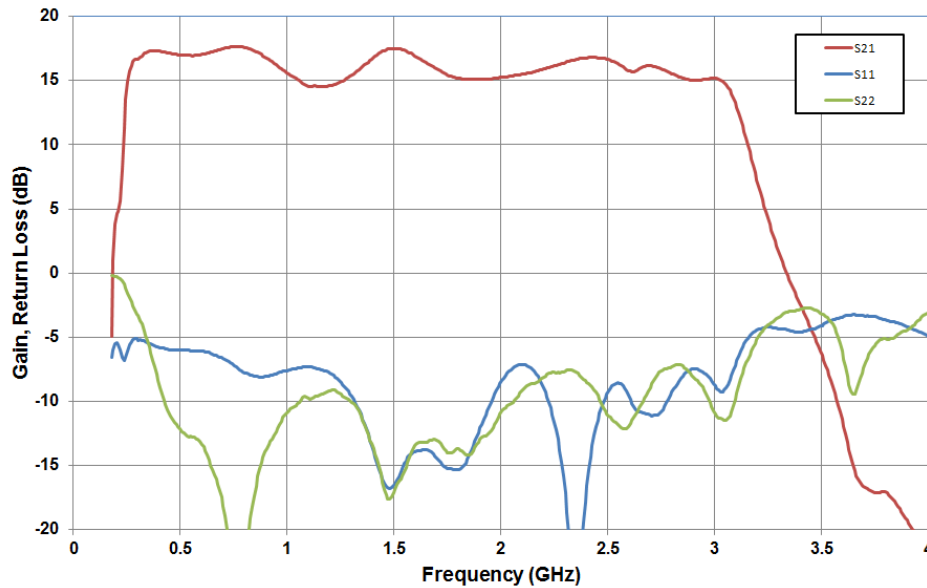
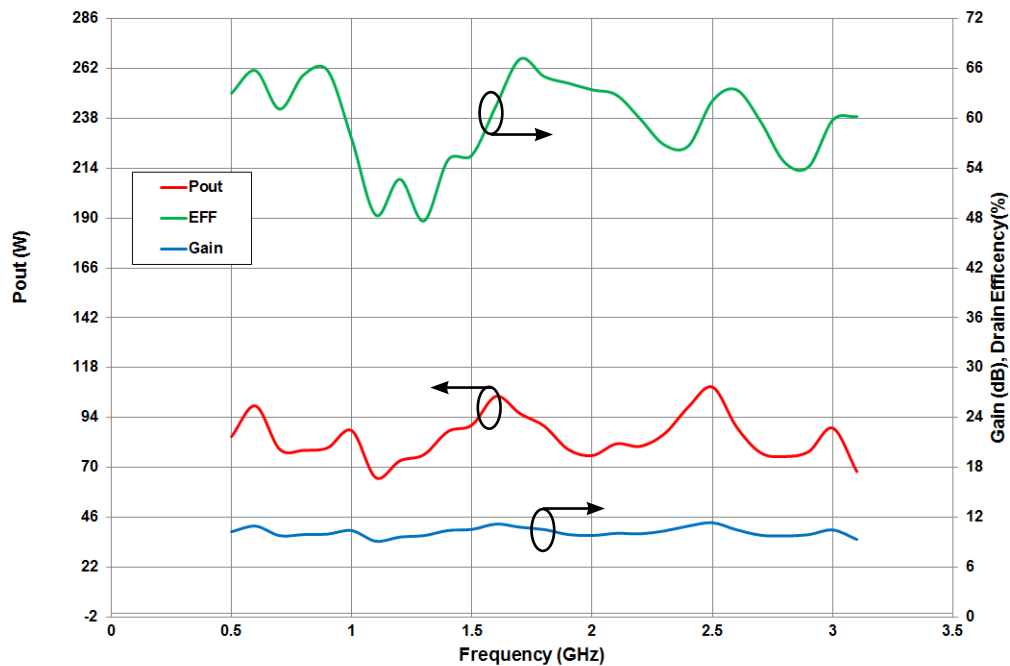


Figure 2 - Output Power and Efficiency of the CG2H30070F vs. Frequency as Measured in the Single-ended Demonstration Amplifier CG2H30070F-AMP
 CW Operation, $V_{DD} = 28\text{ V}, I_{DQ} = 1.0\text{ A}, P_{IN} = 39\text{ dBm}$



CG2H30070F Typical Performance

Figure 3 - Gain and Drain Efficiency vs. Output Power at Various Frequencies as Measured in the Single-ended Demonstration Amplifier CG2H30070F-AMP CW-Operation, $V_{DD} = 28\text{ V}$, $I_{DQ} = 1.0\text{ A}$

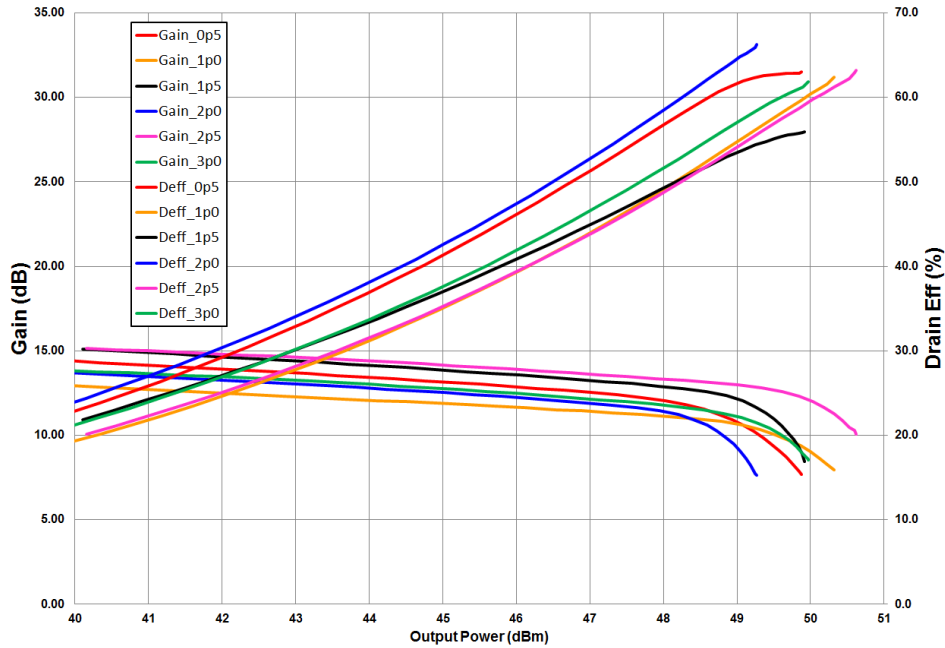
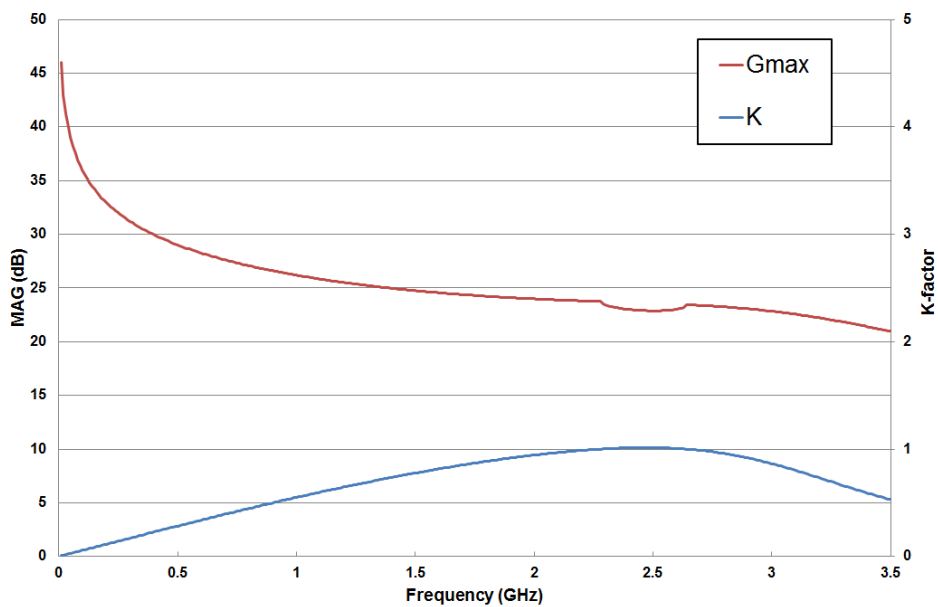
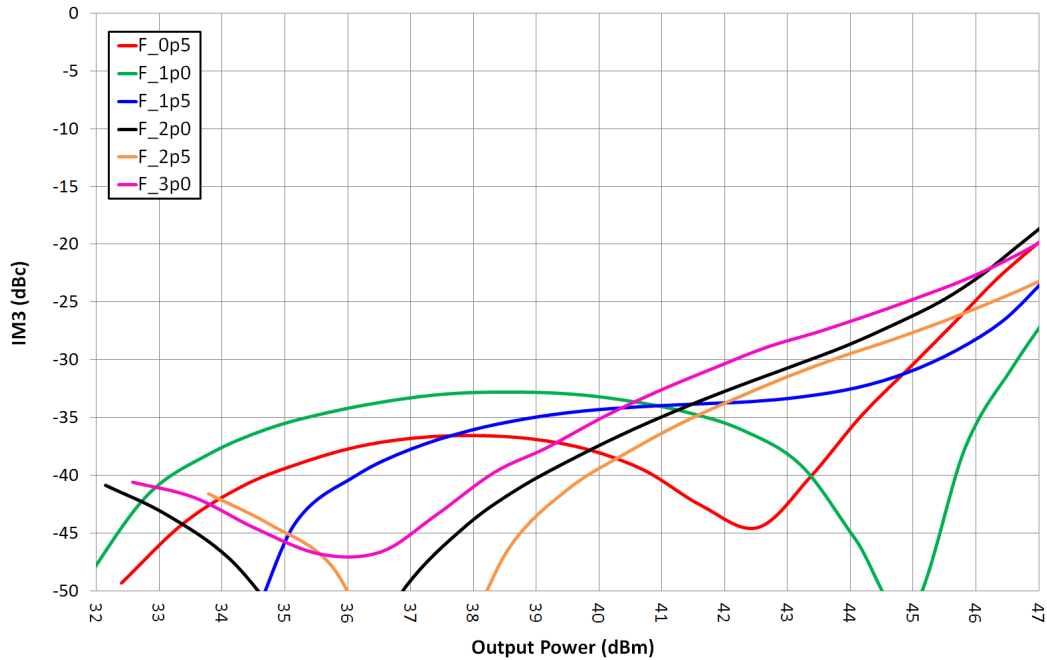


Figure 4 - Simulated Maximum Available Gain and K-factor of the CG2H30070F $V_{DD} = 28\text{ V}$, $I_{DQ} = 1.0\text{ A}$

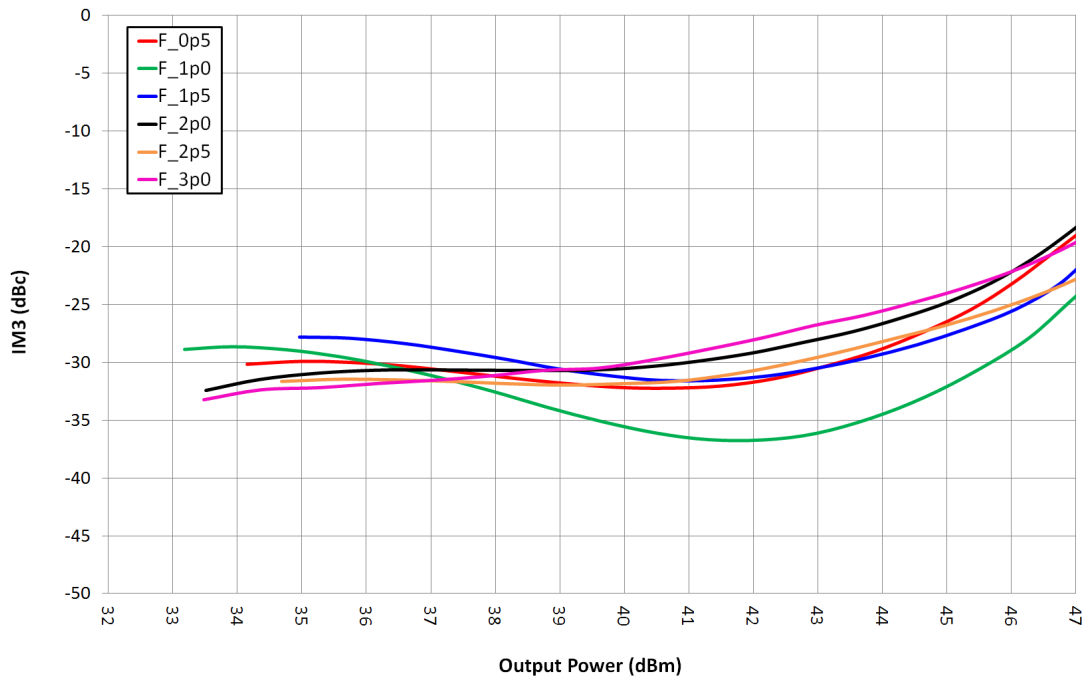


CG2H30070F Typical Performance

**Figure 5 - IM3 vs. Output Power of the CG2H30070F
as Measured in the Single-ended Demonstration Amplifier CG2H30070F-AMP
 $I_{DQ} = 300 \text{ mA}$, Temperature = 25°C**

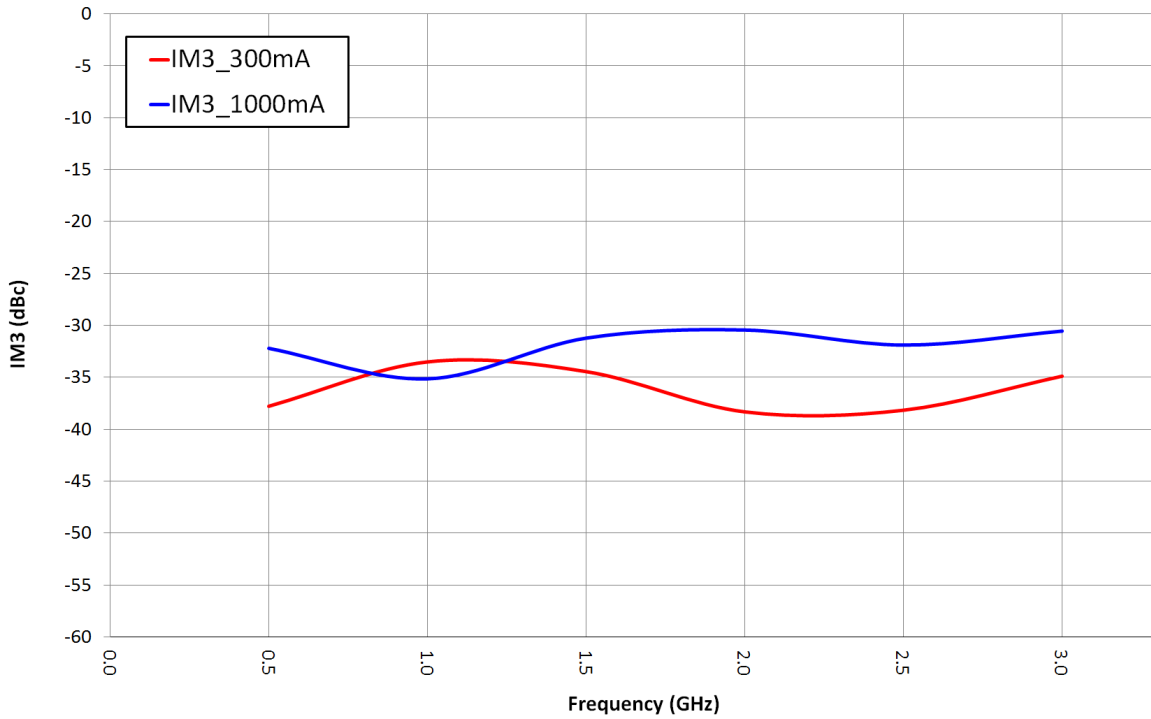


**Figure 6 - IM3 vs. Output Power of the CG2H30070F
as Measured in the Single-ended Demonstration Amplifier CG2H30070F-AMP
 $I_{DQ} = 1000 \text{ mA}$, Temperature = 25°C**

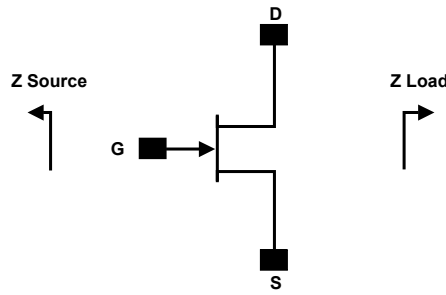


CG2H30070F Typical Performance

**Figure 7 - IM3 vs. Frequency of the CG2H30070F
as Measured in the Single-ended Demonstration Amplifier CG2H30070F-AMP
 $P_{OUT} = 40$ dBm, Temperature = 25°C**



Simulated Source and Load Impedances



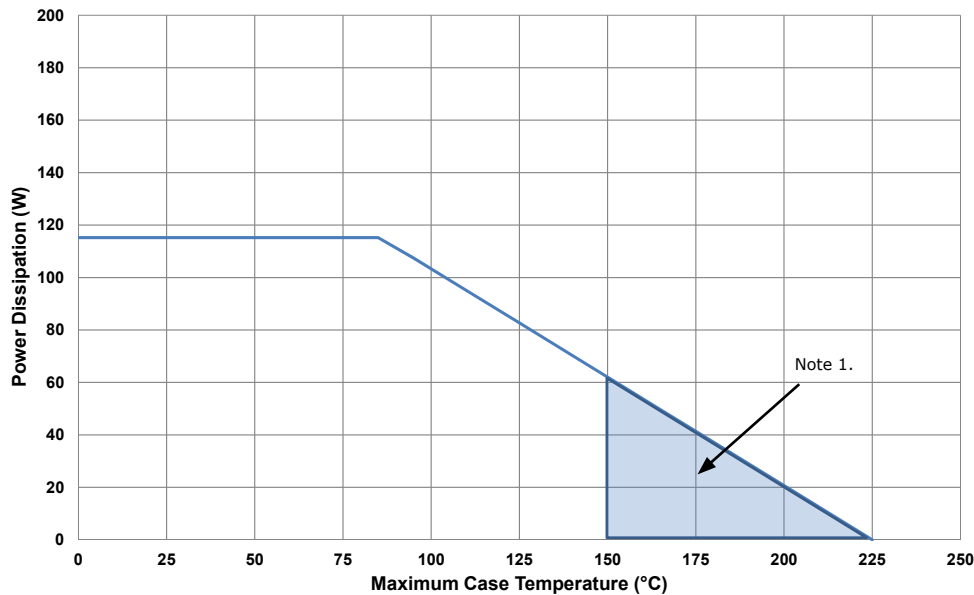
Frequency (MHz)	Z Source	Z Load
500	9 - j5.15	5.79 - j2.56
1000	7.45 - j3.82	4.76 - j1.35
1500	1.7 - j3.24	3.55 + j0.8
2000	2.33 - j0.06	4.19 + j0.19
2500	4.57 - j2.15	4.34 - j1.73
3000	1.07 - j1.04	2.65 - j1.57

Note 1. $V_{DD} = 28\text{ V}$, $I_{DQ} = 1.0\text{ A}$ in the 440224 package.

Note 2. Optimized for power gain, P_{SAT} and Drain Efficiency.

Note 3. When using this device at low frequency, series resistors should be used to maintain amplifier stability.

CG2H30070F Power Dissipation De-rating Curve, CW



Note 1. Area exceeds Maximum Case Operating Temperature (See Page 2).

Typical Combined Performance

The previous plots were created from one side of the wideband application circuit, CG2H30070F-AMP2 in order to demonstrate the RF performance of the transistor over a wide frequency band. The application circuit CG2H30070F-AMP2 is designed to combine two CG2H30070F in order to achieve 100W CW from 0.5-3.0 GHz instantaneously. Figure 7 shows the typical RF performance from CG2H30070F-AMP2.

To achieve this performance, couplers from Innovative Power Products were used. The IPP-2256 uses N-type connectors in order to handle the higher output power from this application circuit and lead to the reason for the spacing seen in the SMA connectors in the application amplifier CG2H30070F-AMP2.

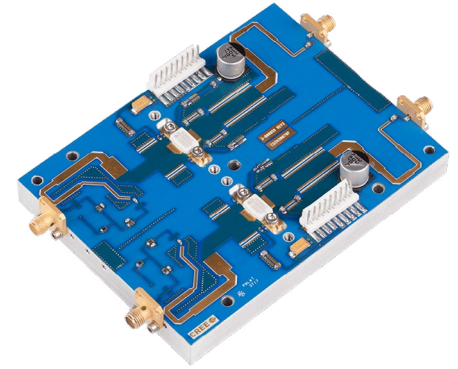
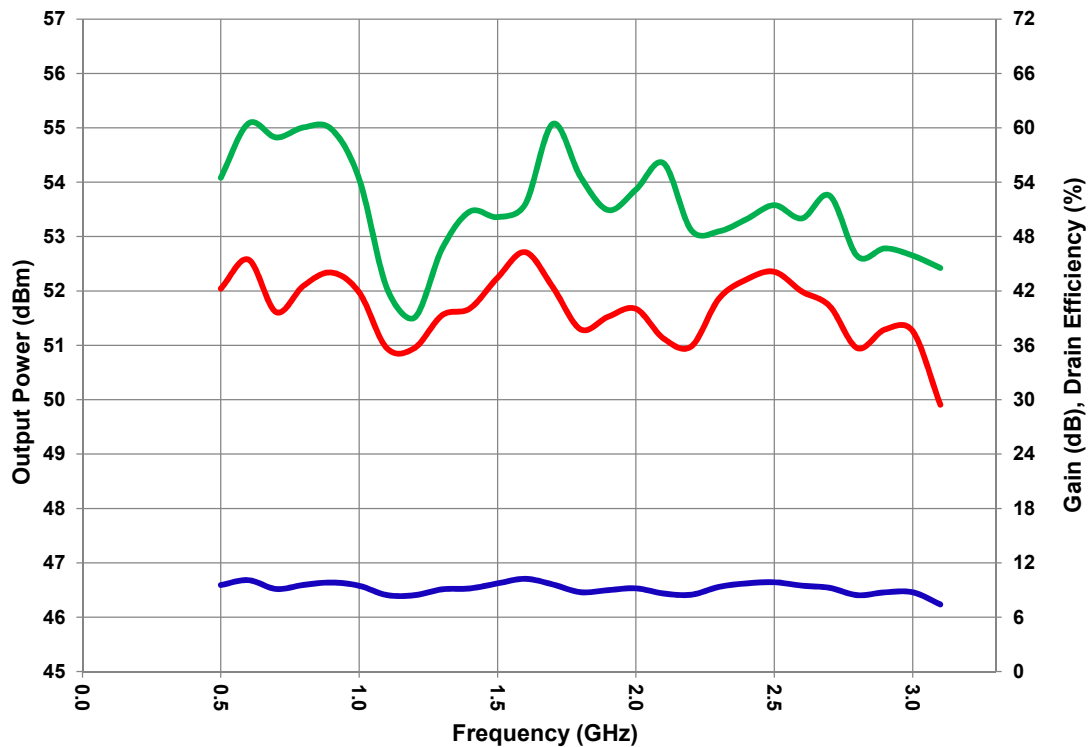
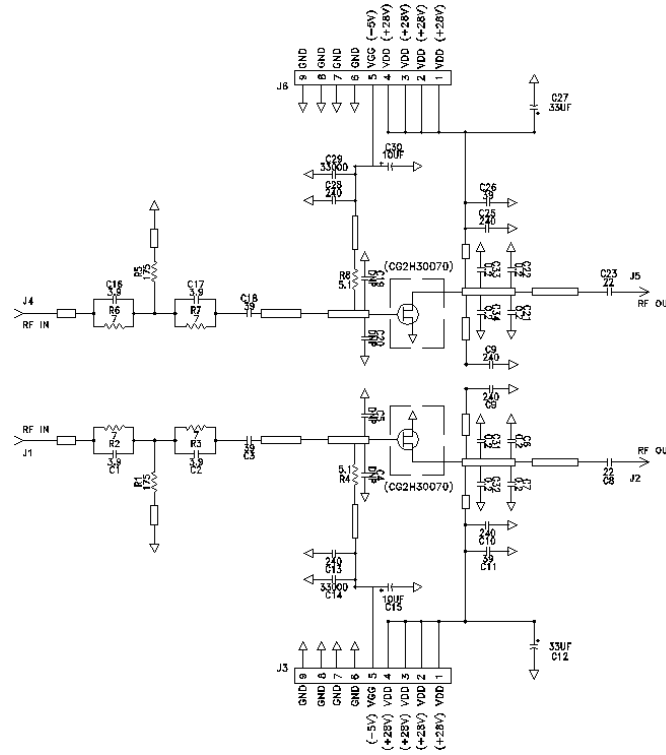


Figure 7 - Output Power, Power Gain and Drain Efficiency vs. Frequency of Two CG2H30070F Combined as Measured in the Combined Demonstration Amplifier CG2H30070F-AMP2 with Couplers

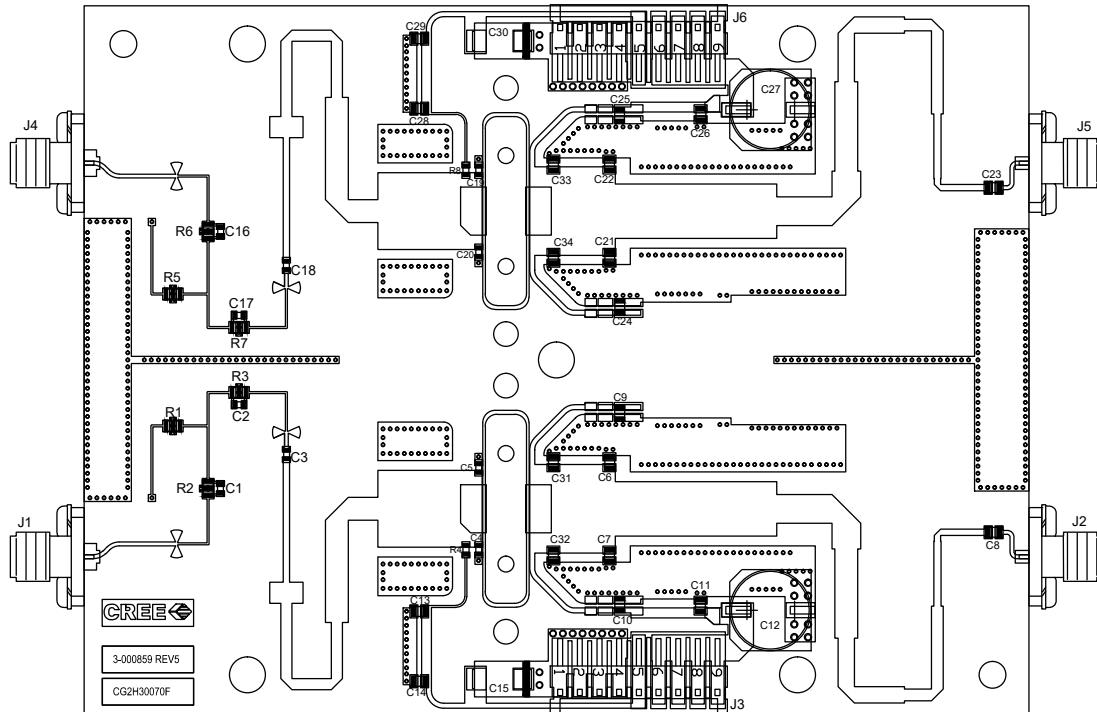
$V_{DD} = 28\text{ V}$, $I_{DQ} = 2\text{ A}$, $P_{IN} = 42.5\text{ dBm}$ Temperature = 25°C



CG2H30070F-AMP2 Demonstration Amplifier Circuit Schematic



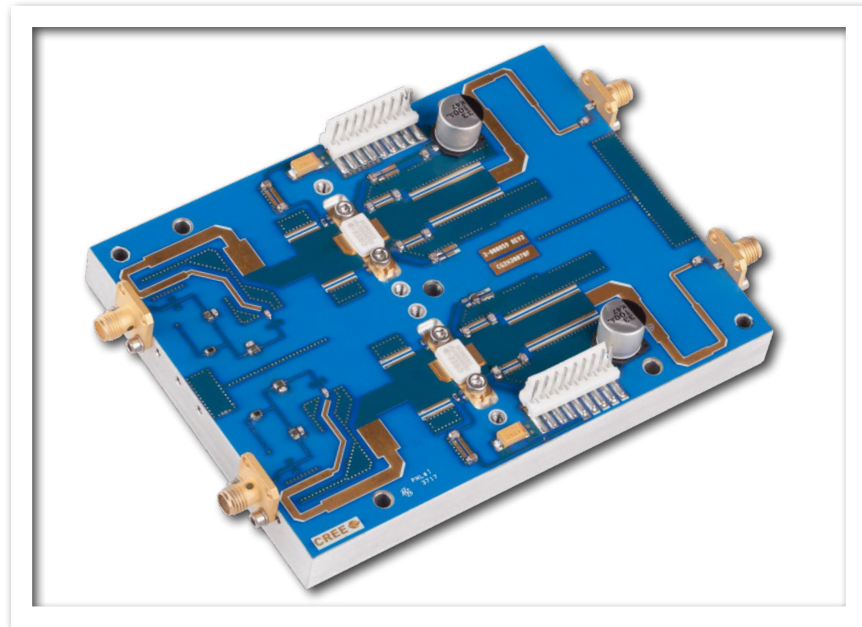
CG2H30070F-AMP2 Demonstration Amplifier Circuit Outline



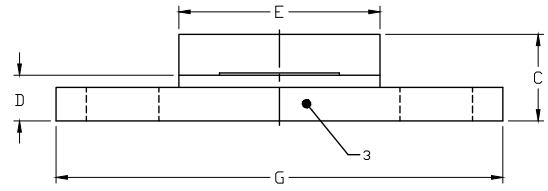
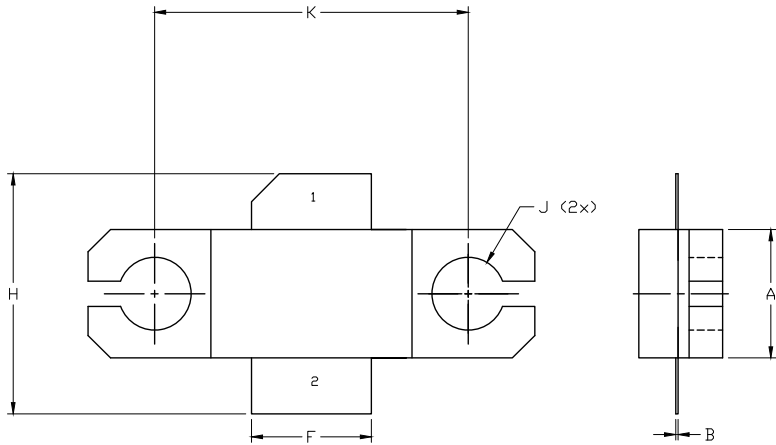
CG2H30070F-AMP2 Demonstration Amplifier Circuit Bill of Materials

Designator	Description	Qty
C11, C26	CAP, 39 pF, ±5%, 250V, 0805, ATC600F	2
C8, C23	CAP, 22 pF, ±5%, 250V, 0805, ATC600F	2
C3, C18	CAP, 39 pF, ±5%, 0603, ATC	2
C14, C29	CAP, 33000PF, 0805, 100V, X7R	2
C15, C30	CAP, 10UF, 16V TANTALUM	2
C13, C9, C10, C28, C24, C25	CAP, 240pF, ±5%, 250V, 0805, ATC600F	6
C6, C7, C31, C32, C21, C22, C33, C34	CAP, 0.2pF, ±0.05%pF, 250V, 0805, ATC600F	8
C4, C5, C19, C20	DO NOT PLACE	0
C1, C2, C16, C17	CAP, 3.9pF, ±0.1pF, 0603, ATC	4
R2, R3, R6, R7	RES, 7 OHM, 0805, HIGH POWER SMT, IMS	4
R1, R5	RES, 175 OHM, 0805, HIGH POWER SMT, IMS	2
R4, R8	RES, 5 OHM, 0603, SMT	2
C12, C27	CAP, 33 UF, 20%, 100V, ELEC	2
J1, J2, J4, J5	CONN, SMA, PANEL MOUNT JACK, FLANGE, 4-HOLE, BLUNT POST, 20 MIL	4
J3, J6	HEADER RT>PLZ .1CEN LK 9POS	2
	PCB, RO6035HTC, 3.6"x4.8"x0.10", CG2H30070F	1
	BASEPLATE, Al, 4.8x3.6x0.5	

CG2H30070F-AMP2 Demonstration Amplifier Circuit



Product Dimensions CG2H30070F (Package Type – 440224)



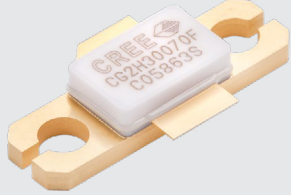
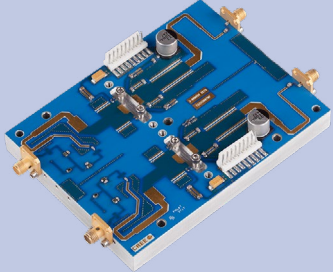
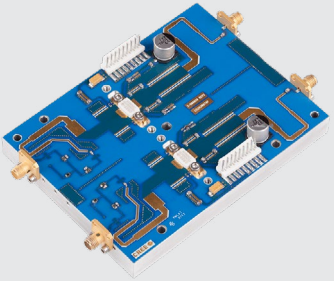
NOTES:

1. DIMENSIONING AND TOLERANCING PER ANSI Y14.5M, 1982.
2. CONTROLLING DIMENSION: INCH.
3. ADHESIVE FROM LID MAY EXTEND A MAXIMUM OF 0.020" BEYOND EDGE OF LID.
4. LID MAY BE MISALIGNED TO THE BODY OF THE PACKAGE BY A MAXIMUM OF 0.008" IN ANY DIRECTION.
5. ALL PLATED SURFACES ARE NI/AU

DIM	INCHES		MILLIMETERS	
	MIN	MAX	MIN	MAX
A	0.225	0.235	5.72	5.97
B	0.004	0.006	0.10	0.15
C	0.145	0.165	3.68	4.19
D	0.077	0.087	1.96	2.21
E	0.355	0.365	9.02	9.27
F	0.210	0.220	5.33	5.59
G	0.795	0.805	20.19	20.45
H	0.400	0.460	10.16	11.68
J	∅ .130		3.30	
k	0.562		14.27	

- PIN 1. GATE
 PIN 2. DRAIN
 PIN 3. SOURCE

Product Ordering Information

Order Number	Description	Unit of Measure	Image
CG2H30070F	GaN HEMT	Each	
CG2H30070F-TB2	Test board without GaN HEMT	Each	
CG2H30070F-AMP2	Test board with GaN HEMT installed	Each	



Disclaimer

Specifications are subject to change without notice. Cree, Inc. believes the information contained within this data sheet to be accurate and reliable. However, no responsibility is assumed by Cree for any infringement of patents or other rights of third parties which may result from its use. No license is granted by implication or otherwise under any patent or patent rights of Cree. Cree makes no warranty, representation or guarantee regarding the suitability of its products for any particular purpose. "Typical" parameters are the average values expected by Cree in large quantities and are provided for information purposes only. These values can and do vary in different applications and actual performance can vary over time. All operating parameters should be validated by customer's technical experts for each application. Cree products are not designed, intended or authorized for use as components in applications intended for surgical implant into the body or to support or sustain life, in applications in which the failure of the Cree product could result in personal injury or death or in applications for planning, construction, maintenance or direct operation of a nuclear facility.

For more information, please contact:

Cree, Inc.
4600 Silicon Drive
Durham, North Carolina, USA 27703
www.cree.com/RF

Sarah Miller
Marketing & Export
Cree, RF Components
1.919.407.5302

Ryan Baker
Marketing
Cree, RF Components
1.919.407.7816

Tom Dekker
Sales Director
Cree, RF Components
1.919.407.5639

Компания «Океан Электроники» предлагает заключение долгосрочных отношений при поставках импортных электронных компонентов на взаимовыгодных условиях!

Наши преимущества:

- Поставка оригинальных импортных электронных компонентов напрямую с производств Америки, Европы и Азии, а так же с крупнейших складов мира;
- Широкая линейка поставок активных и пассивных импортных электронных компонентов (более 30 млн. наименований);
- Поставка сложных, дефицитных, либо снятых с производства позиций;
- Оперативные сроки поставки под заказ (от 5 рабочих дней);
- Экспресс доставка в любую точку России;
- Помощь Конструкторского Отдела и консультации квалифицированных инженеров;
- Техническая поддержка проекта, помощь в подборе аналогов, поставка прототипов;
- Поставка электронных компонентов под контролем ВП;
- Система менеджмента качества сертифицирована по Международному стандарту ISO 9001;
- При необходимости вся продукция военного и аэрокосмического назначения проходит испытания и сертификацию в лаборатории (по согласованию с заказчиком);
- Поставка специализированных компонентов военного и аэрокосмического уровня качества (Xilinx, Altera, Analog Devices, Intersil, Interpoint, Microsemi, Actel, Aeroflex, Peregrine, VPT, Syfer, Eurofarad, Texas Instruments, MS Kennedy, Miteq, Cobham, E2V, MA-COM, Hittite, Mini-Circuits, General Dynamics и др.);

Компания «Океан Электроники» является официальным дистрибьютором и эксклюзивным представителем в России одного из крупнейших производителей разъемов военного и аэрокосмического назначения «JONHON», а так же официальным дистрибьютором и эксклюзивным представителем в России производителя высокотехнологичных и надежных решений для передачи СВЧ сигналов «FORSTAR».



JONHON

«JONHON» (основан в 1970 г.)

Разъемы специального, военного и аэрокосмического назначения:

(Применяются в военной, авиационной, аэрокосмической, морской, железнодорожной, горно- и нефтедобывающей отраслях промышленности)

«FORSTAR» (основан в 1998 г.)

ВЧ соединители, коаксиальные кабели, кабельные сборки и микроволновые компоненты:

(Применяются в телекоммуникациях гражданского и специального назначения, в средствах связи, РЛС, а так же военной, авиационной и аэрокосмической отраслях промышленности).



Телефон: 8 (812) 309-75-97 (многоканальный)

Факс: 8 (812) 320-03-32

Электронная почта: ocean@oceanchips.ru

Web: <http://oceanchips.ru/>

Адрес: 198099, г. Санкт-Петербург, ул. Калинина, д. 2, корп. 4, лит. А