

Series 01

Characteristics

The compact 16mm Series 01 is especially suited for:

- Raised design

This series is ideally suited for combined use with Series 51.

Functions

The Series 01 incorporates the following functions:

- Indicator
- Pushbutton
- Illuminated pushbutton

Market segments

The EAO Series 01 is especially suited for applications in the segments:

- Machinery and Automation
- Panel building

Please refer to the EAO website to obtain detailed information regarding this series www.products.eao.com
Configure a product to your exact needs and request a quotation.



| | | |
|---------------------------|-----------|-----------|
| Overview | | 01 |
| Raised design | | 02 |
| Indicator | 4 | |
| Illuminated pushbutton | 6 | 03 |
| Accessoires | 10 | 04 |
| Drawings | 22 | 10 |
| Technical data | 23 | 14 |
| Marking | 25 | 17 |
| Guidelines for use | 26 | 18 |
| Index | 28 | 19 |

| |
|----|
| 01 |
| 02 |
| 03 |
| 04 |
| 10 |
| 14 |
| 17 |
| 18 |
| 19 |
| 22 |
| 31 |
| 41 |
| 44 |
| 51 |
| 56 |
| 57 |
| 61 |
| 70 |
| 71 |
| 82 |
| 84 |
| 92 |
| 95 |
| 96 |
| 97 |
| 99 |
| ST |

01 Raised design

Indicator, IP 40



Product can differ from the current configuration.



Dimensions [mm]
 H = Universal terminal 2.0 x 0.5 mm,
 L = Solder terminal,
 L1 = Solder terminal 2.8 x 0.5 mm



Mounting cut-outs [mm]

Equipment consisting of (schematic overview)

| | | |
|--|-------------------|---------|
| | Lens | page 10 |
| | Single-LED | page 17 |
| | Actuator | |
| | Fixing nut | |

Each Part Number listed below includes all the black components shown in the 3D-drawing.

To obtain a complete unit, please select the red components from the pages shown.

| Diode 1N4007 | Terminal | Part No. | Component layout | Wiring diagram | Weight |
|--------------|---|-------------------|------------------|----------------|----------|
| | Indicator actuator, Front dimension 18 x 18 mm | | | | |
| 1 | Universal 2.0 x 0.5 mm | 01-703.006 | 4 | 1 | 0.008 kg |
| 2 | Universal 2.0 x 0.5 mm | 01-704.006 | 4 | 2 | 0.008 kg |
| | Solder 2.8 x 0.5 mm | 01-050.002 | | 3 | 0.006 kg |
| | Solder | 01-050.005 | | 3 | 0.006 kg |
| | Universal 2.0 x 0.5 mm | 01-051.006 | 4 | 3 | 0.006 kg |
| | Indicator actuator, Front dimension 18 x 24 mm | | | | |
| 1 | Universal 2.0 x 0.5 mm | 01-701.006 | 4 | 1 | 0.008 kg |
| 2 | Universal 2.0 x 0.5 mm | 01-702.006 | 4 | 2 | 0.008 kg |
| | Solder 2.8 x 0.5 mm | 01-040.002 | | 3 | 0.006 kg |
| | Solder | 01-040.005 | | 3 | 0.006 kg |
| | Universal 2.0 x 0.5 mm | 01-041.006 | 4 | 3 | 0.006 kg |

| Diode 1N4007 | | Terminal | Part No. | Component layout | Wiring diagram | Weight |
|---|------------------------|-------------------|----------|------------------|----------------|--------|
|  <p>Indicator actuator, Front dimension Ø 18 mm</p> | | | | | | |
| 1 | Universal 2.0 x 0.5 mm | 01-741.006 | 4 | 1 | 0.008 kg | |
| 2 | Universal 2.0 x 0.5 mm | 01-742.006 | 4 | 2 | 0.008 kg | |
| | Solder 2.8 x 0.5 mm | 01-030.002 | | 3 | 0.006 kg | |
| | Solder | 01-030.005 | | 3 | 0.006 kg | |
| | Universal 2.0 x 0.5 mm | 01-031.006 | 4 | 3 | 0.006 kg | |

The component layouts you will find from page 22



01
02
03
04
10
14
17
18
19
22
31
41
44
51
56
57
61
70
71
82
84
92
95
96
97
99
ST

01 Raised design

Illuminated pushbutton, IP 40



Product can differ from the current configuration.



Dimensions [mm]
 H = Universal terminal 2.0 x 0.5 mm,
 H1 = Universal-Solder terminal,
 L = Solder terminal,
 L1 = Solder terminal 2.8 x 0.5 mm

Equipment consisting of (schematic overview)



Each Part Number listed below includes all the black components shown in the 3D-drawing.

To obtain a complete unit, please select the red components from the pages shown.

Additional Information

- Material of contact Gold



Mounting cut-outs [mm]

| Switching system | Contacts | Diode 1N4007 | Switching action | Terminal | Part No. | Component layout | Wiring diagram | Weight | |
|--|-------------------------------|--------------|------------------------|------------------------|------------------------|--------------------|--------------------|----------|----------|
|  Illuminated pushbutton actuator, Front dimension 18 x 18 mm | Low-level element | | B | Universal 2.0 x 0.5 mm | 01-456.036 | 4 | 1 | 0.009 kg | |
| | | | C | Universal 2.0 x 0.5 mm | 01-486.036 | 4 | 2 | 0.009 kg | |
| | | | 1 NC + 1 NO | B | Universal 2.0 x 0.5 mm | 01-453.036 | 4 | 3 | 0.009 kg |
| | | | | C | Universal 2.0 x 0.5 mm | 01-483.036 | 4 | 4 | 0.009 kg |
| | | | 1 NO | B | Universal 2.0 x 0.5 mm | 01-455.036 | 4 | 5 | 0.009 kg |
| | | | | C | Universal 2.0 x 0.5 mm | 01-485.036 | 4 | 6 | 0.009 kg |
| | 2 NC | B | Universal 2.0 x 0.5 mm | 01-452.036 | 4 | 7 | 0.009 kg | | |
| | | C | Universal 2.0 x 0.5 mm | 01-482.036 | 4 | 8 | 0.009 kg | | |
| | Snap-action switching element | 1 NC + 1 NO | 1 | B | Universal-Solder | 01-709.0292 | 4 | 11 | 0.010 kg |
| | | | | C | Universal-Solder | 01-717.0292 | 4 | 12 | 0.010 kg |
| | | | | 2 | B | Universal-Solder | 01-710.0292 | 4 | 13 |
| | | | C | | Universal-Solder | 01-718.0292 | 4 | 14 | 0.010 kg |
| | | | B | | Solder | 01-151.0252 | | 15 | 0.008 kg |
| | | | B | Solder 2.8 x 0.5 mm | 01-151.022 | | 16 | 0.008 kg | |
| | C | Solder | 01-281.0252 | | 17 | 0.008 kg | | | |
| 2 NC + 2 NO | 1 | C | Solder 2.8 x 0.5 mm | 01-281.022 | | 18 | 0.008 kg | | |
| | | B | Universal-Solder | 01-711.0292 | 4 | 19 | 0.012 kg | | |
| | | | C | Universal-Solder | 01-719.0292 | 4 | 20 | 0.012 kg | |

| Switching system | Contacts | Diode 1N4007 | Switching action | Terminal | Part No. | Component layout | Wiring diagram | Weight |
|-------------------------------|-------------|--------------|------------------|------------------|--------------------|------------------|----------------|----------|
| Snap-action switching element | 2 Ö + 2 S | 2 | B | Universal-Solder | 01-712.0292 | 4 | 21 | 0.012 kg |
| | | | C | Universal-Solder | 01-720.0292 | 4 | 22 | 0.012 kg |
| | | 1 | B | Solder | 01-152.0252 | | 23 | 0.010 kg |
| | | | C | Solder | 01-282.0252 | | 24 | 0.010 kg |
| | 3 NC + 3 NO | | B | Solder | 01-153.0252 | | 25 | 0.012 kg |
| | | | C | Solder | 01-283.0252 | | 26 | 0.012 kg |
| | 4 NC + 4 NO | | B | Solder | 01-154.0252 | | 27 | 0.014 kg |
| | | | C | Solder | 01-284.0252 | | 28 | 0.014 kg |



Illuminated pushbutton actuator, Front dimension 18 x 24 mm

| | | | | | | | | | |
|-------------------|-------------------------------|-------------|---|------------------------|--------------------|--------------------|----|----------|----------|
| Low-level element | 1 NC | | B | Universal 2.0 x 0.5 mm | 01-426.036 | 4 | 1 | 0.009 kg | |
| | | | C | Universal 2.0 x 0.5 mm | 01-466.036 | 4 | 2 | 0.009 kg | |
| | 1 NC + 1 NO | | B | Universal 2.0 x 0.5 mm | 01-423.036 | 4 | 3 | 0.009 kg | |
| | | | C | Universal 2.0 x 0.5 mm | 01-463.036 | 4 | 4 | 0.009 kg | |
| | 1 NO | | B | Universal 2.0 x 0.5 mm | 01-425.036 | 4 | 5 | 0.009 kg | |
| | | | C | Universal 2.0 x 0.5 mm | 01-465.036 | 4 | 6 | 0.009 kg | |
| | 2 NC | | B | Universal 2.0 x 0.5 mm | 01-422.036 | 4 | 7 | 0.009 kg | |
| | | | C | Universal 2.0 x 0.5 mm | 01-462.036 | 4 | 8 | 0.009 kg | |
| | 2 NO | | B | Universal 2.0 x 0.5 mm | 01-421.036 | 4 | 9 | 0.009 kg | |
| | | | C | Universal 2.0 x 0.5 mm | 01-461.036 | 4 | 10 | 0.009 kg | |
| | Snap-action switching element | 1 NC + 1 NO | 1 | B | Universal-Solder | 01-705.0292 | 4 | 11 | 0.010 kg |
| | | | | C | Universal-Solder | 01-713.0292 | 4 | 12 | 0.010 kg |
| 2 | | | | B | Universal-Solder | 01-706.0292 | 4 | 13 | 0.010 kg |
| | | | | C | Universal-Solder | 01-714.0292 | 4 | 14 | 0.010 kg |
| | | | B | Solder | 01-121.0252 | | 15 | 0.008 kg | |
| | | | B | Solder 2.8 x 0.5 mm | 01-121.022 | | 16 | 0.008 kg | |
| | | | C | Solder | 01-261.0252 | | 17 | 0.008 kg | |
| | | | C | Solder 2.8 x 0.5 mm | 01-261.022 | | 18 | 0.008 kg | |
| 2 NC + 2 NO | | 1 | B | Universal-Solder | 01-707.0292 | 4 | 19 | 0.012 kg | |
| | | | C | Universal-Solder | 01-715.0292 | 4 | 20 | 0.012 kg | |
| | | 2 | B | Universal-Solder | 01-708.0292 | 4 | 21 | 0.012 kg | |
| | | | 1 | C | Universal-Solder | 01-716.0292 | 4 | 22 | 0.012 kg |
| | | | | B | Solder | 01-122.0252 | | 23 | 0.010 kg |
| | | | C | Solder | 01-262.0252 | | 24 | 0.010 kg | |
| 3 NC + 3 NO | | | B | Solder | 01-123.0252 | | 25 | 0.012 kg | |
| | | | C | Solder | 01-263.0252 | | 26 | 0.012 kg | |
| 4 NC + 4 NO | | | B | Solder | 01-124.0252 | | 27 | 0.014 kg | |
| | | | C | Solder | 01-264.0252 | | 28 | 0.014 kg | |

01
02
03
04
10
14
17
18
19
22
31
41
44
51
56
57
61
70
71
82
84
92
95
96
97
99
ST

01 Raised design

| Switching system | Contacts | Diode 1N4007 | Switching action | Terminal | Part No. | Component layout | Wiring diagram | Weight | |
|--|-------------------------------|--------------|------------------|------------------------|--------------------|--------------------|----------------|----------|----------|
|  <p>Illuminated pushbutton actuator, Front dimension Ø 18 mm</p> | | | | | | | | | |
| Low-level element | 1 NC | | B | Universal 2.0 x 0.5 mm | 01-436.036 | 4 | 1 | 0.009 kg | |
| | | | C | Universal 2.0 x 0.5 mm | 01-476.036 | 4 | 2 | 0.009 kg | |
| | 1 NC + 1 NO | | B | Universal 2.0 x 0.5 mm | 01-433.036 | 4 | 3 | 0.009 kg | |
| | | | C | Universal 2.0 x 0.5 mm | 01-473.036 | 4 | 4 | 0.009 kg | |
| | 1 NO | | B | Universal 2.0 x 0.5 mm | 01-435.036 | 4 | 5 | 0.009 kg | |
| | | | C | Universal 2.0 x 0.5 mm | 01-475.036 | 4 | 6 | 0.009 kg | |
| | 2 NC | | B | Universal 2.0 x 0.5 mm | 01-432.036 | 4 | 7 | 0.009 kg | |
| | | | C | Universal 2.0 x 0.5 mm | 01-472.036 | 4 | 8 | 0.009 kg | |
| | 2 NO | | B | Universal 2.0 x 0.5 mm | 01-431.036 | 4 | 9 | 0.009 kg | |
| | | | C | Universal 2.0 x 0.5 mm | 01-471.036 | 4 | 10 | 0.009 kg | |
| | Snap-action switching element | 1 NC + 1 NO | 1 | B | Universal-Solder | 01-743.0292 | 4 | 11 | 0.010 kg |
| | | | | C | Universal-Solder | 01-747.0292 | 4 | 12 | 0.010 kg |
| 2 | | | B | Universal-Solder | 01-744.0292 | 4 | 13 | 0.010 kg | |
| | | | C | Universal-Solder | 01-748.0292 | 4 | 14 | 0.010 kg | |
| | | | B | Solder | 01-131.0252 | | 15 | 0.008 kg | |
| | | | C | Solder 2.8 x 0.5 mm | 01-131.022 | | 16 | 0.008 kg | |
| 2 NC + 2 NO | | 1 | B | Universal-Solder | 01-745.0292 | 4 | 19 | 0.012 kg | |
| | | | C | Universal-Solder | 01-749.0292 | 4 | 20 | 0.012 kg | |
| | | 2 | B | Universal-Solder | 01-746.0292 | 4 | 21 | 0.012 kg | |
| | | | C | Universal-Solder | 01-750.0292 | 4 | 22 | 0.012 kg | |
| | | | B | Solder | 01-132.0252 | | 23 | 0.010 kg | |
| | | | C | Solder | 01-272.0252 | | 24 | 0.010 kg | |
| 3 NC + 3 NO | | | B | Solder | 01-133.0252 | | 25 | 0.012 kg | |
| | | | C | Solder | 01-273.0252 | | 26 | 0.012 kg | |
| 4 NC + 4 NO | | | B | Solder | 01-134.0252 | | 27 | 0.014 kg | |
| | | | C | Solder | 01-274.0252 | | 28 | 0.014 kg | |

Contacts: NC = Normally closed, NO = Normally open
 Switching action: B = Momentary, C = Maintain
 The component layouts you will find from page 22

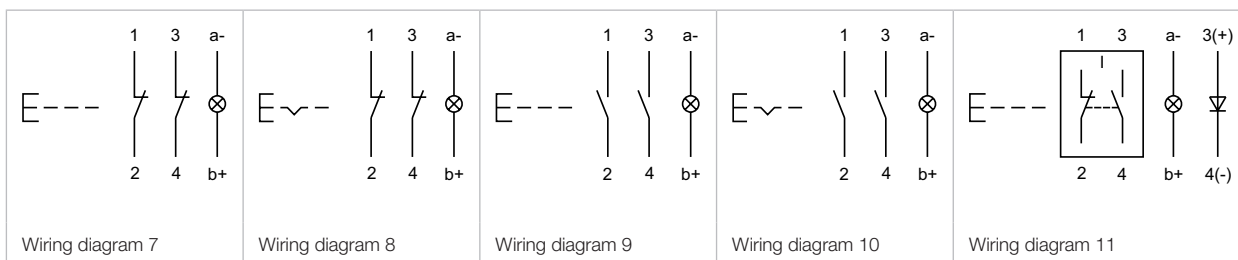

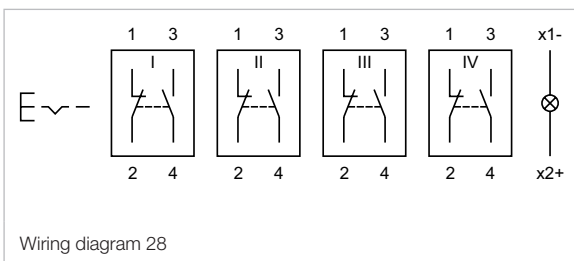
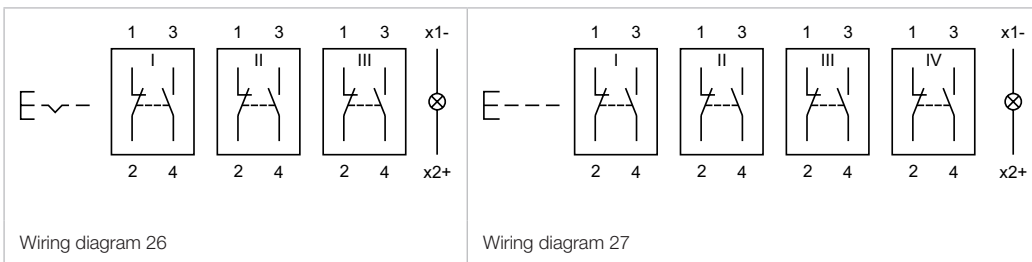
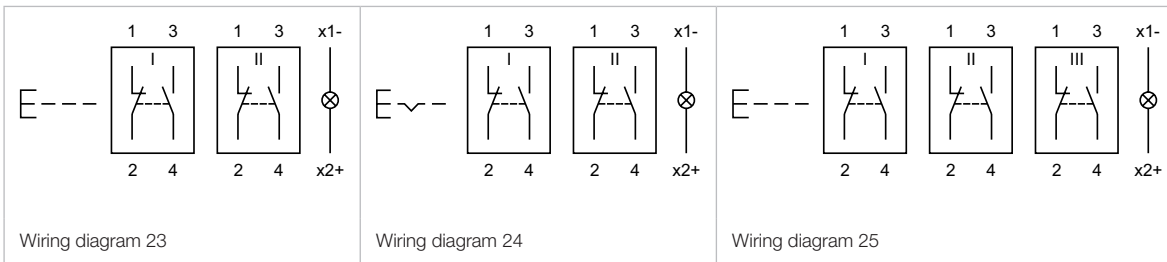
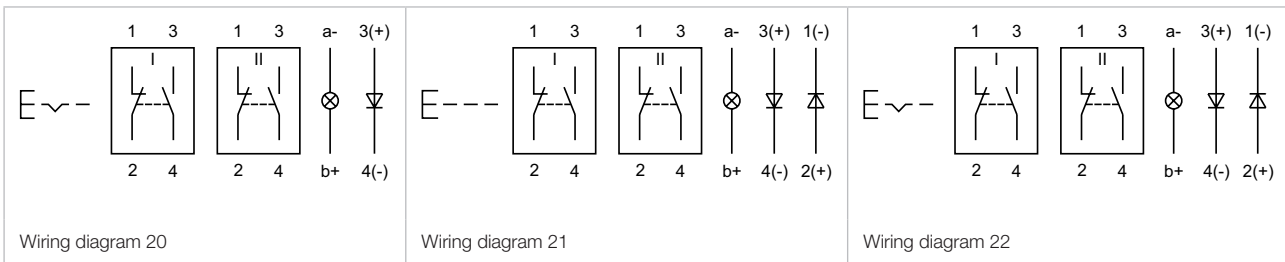
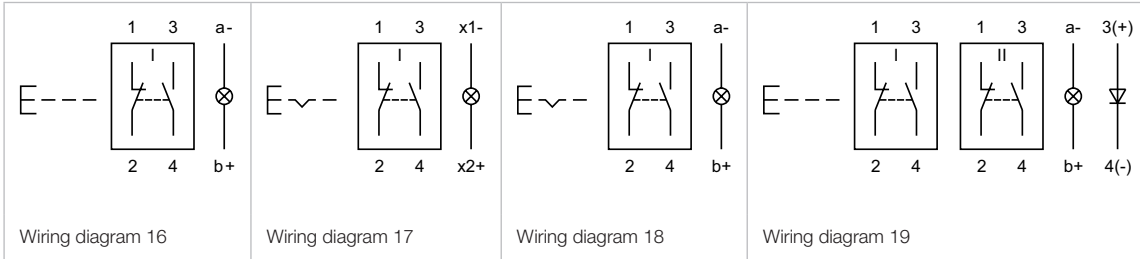

- 01
- 02
- 03
- 04
- 10
- 14
- 17
- 18
- 19
- 22
- 31
- 41
- 44
- 51
- 56
- 57
- 61
- 70
- 71
- 82
- 84
- 92
- 95
- 96
- 97
- 99
- ST

01 Accessories

Front

Lens plastic

| Product attribute | Dimension | Lens | Part No. | Weight |
|---|----------------|------------------------|-----------------|----------|
|  Lens plastic | | | | |
| flat, illuminative | 12.8 x 12.8 mm | red transparent | 01-985.2 | 0.001 kg |
| | | orange transparent | 01-985.3 | 0.001 kg |
| | | yellow transparent | 01-985.4 | 0.001 kg |
| | | green transparent | 01-985.5 | 0.001 kg |
| | | blue transparent | 01-985.6 | 0.001 kg |
| | | colourless transparent | 01-985.7 | 0.001 kg |
| flat, illuminative, not suitable for film insert | 12.8 x 12.8 mm | red translucent | 01-951.2 | 0.001 kg |
| | | orange translucent | 01-951.3 | 0.001 kg |
| | | yellow translucent | 01-951.4 | 0.001 kg |
| | | green translucent | 01-951.5 | 0.001 kg |
| | | blue translucent | 01-951.6 | 0.001 kg |
| | | white translucent | 01-951.9 | 0.001 kg |
| flat, illuminative, less suitable for film insert | 12.8 x 12.8 mm | red transparent | 01-975.2 | 0.001 kg |
| | | yellow transparent | 01-975.4 | 0.001 kg |
| | | green transparent | 01-975.5 | 0.001 kg |
| | | colourless transparent | 01-975.7 | 0.001 kg |
| flat, non-illuminative | 12.8 x 12.8 mm | black opaque | 01-951.0 | 0.001 kg |
| | | grey opaque | 01-951.8 | 0.001 kg |
|  Lens plastic | | | | |
| flat, illuminative | 12.8 x 18.8 mm | red transparent | 01-982.2 | 0.001 kg |
| | | orange transparent | 01-982.3 | 0.001 kg |
| | | yellow transparent | 01-982.4 | 0.001 kg |
| | | green transparent | 01-982.5 | 0.001 kg |
| | | blue transparent | 01-982.6 | 0.001 kg |
| | | colourless transparent | 01-982.7 | 0.001 kg |
| flat, illuminative, not suitable for film insert | 12.8 x 18.8 mm | red translucent | 01-901.2 | 0.001 kg |
| | | orange translucent | 01-901.3 | 0.001 kg |
| | | yellow translucent | 01-901.4 | 0.001 kg |
| | | green translucent | 01-901.5 | 0.001 kg |
| | | blue translucent | 01-901.6 | 0.001 kg |
| | | white translucent | 01-901.9 | 0.001 kg |
| flat, illuminative, less suitable for film insert | 12.8 x 18.8 mm | red transparent | 01-972.2 | 0.001 kg |
| | | yellow transparent | 01-972.4 | 0.001 kg |
| | | green transparent | 01-972.5 | 0.001 kg |
| | | colourless transparent | 01-972.7 | 0.001 kg |
| flat, non-illuminative | 12.8 x 18.8 mm | black opaque | 01-901.0 | 0.001 kg |
| | | grey opaque | 01-901.8 | 0.001 kg |

| Product attribute | Dimension | Lens | Part No. | Weight |
|--|-----------|------------------------|-----------------|----------|
|  <p>Lens plastic</p> | Ø 15.8 mm | red transparent | 01-983.2 | 0.001 kg |
| | | orange transparent | 01-983.3 | 0.001 kg |
| | | yellow transparent | 01-983.4 | 0.001 kg |
| | | green transparent | 01-983.5 | 0.001 kg |
| | | blue transparent | 01-983.6 | 0.001 kg |
| flat, illuminative, not suitable for film insert | Ø 15.8 mm | colourless transparent | 01-983.7 | 0.001 kg |
| | | red translucent | 01-931.2 | 0.001 kg |
| | | orange translucent | 01-931.3 | 0.001 kg |
| | | yellow translucent | 01-931.4 | 0.001 kg |
| | | green translucent | 01-931.5 | 0.001 kg |
| flat, illuminative, less suitable for film insert | Ø 15.8 mm | blue translucent | 01-931.6 | 0.001 kg |
| | | white translucent | 01-931.9 | 0.001 kg |
| | | red transparent | 01-973.2 | 0.001 kg |
| | | yellow transparent | 01-973.4 | 0.001 kg |
| flat, non-illuminative | Ø 15.8 mm | green transparent | 01-973.5 | 0.001 kg |
| | | colourless transparent | 01-973.7 | 0.001 kg |
| | | black opaque | 01-931.0 | 0.001 kg |
| | | grey opaque | 01-931.8 | 0.001 kg |

01
02
03
04
10
14
17
18
19
22
31
41
44
51
56
57
61
70
71
82
84
92
95
96
97
99
ST

01 Accessories

Protective cover, IP 40

Additional Information

- Hinged, with means for sealing
- Front panel thickness reduces by 2 mm
- Please note that bigger minimum distances are necessary



Dimensions [mm]

| Product attribute | Material | Optics | Dimension | Part No. | Weight |
|--|----------|-------------|------------|---------------|----------|
|  Protective cover | | | | | |
| for button 18 x 18 mm with mounting cut-out Ø16 mm | Plastic | transparent | | 31-920 | 0.002 kg |
|  Protective cover | | | | | |
| for button 18 x 24 mm with mounting cut-out Ø16 mm | Plastic | transparent | 18 x 24 mm | 01-925 | 0.002 kg |

Front protective cap, IP 67

Additional Information

- Two-part
- Please note that bigger minimum distances are necessary



Dimensions [mm]

| Product attribute | Dimension | Material | Colour | Optics | Part No. | Weight |
|--|------------|-------------|------------|-------------|-----------------|----------|
|  Front protective cap | | | | | | |
| for button 18 x 18 mm with mounting cut-out Ø16 mm | 24 x 24 mm | PVC/PE | colourless | transparent | 31-923 | 0.003 kg |
| for button 18 x 24 mm with mounting cut-out Ø16 mm | 24 x 30 mm | PE/Silicone | colourless | transparent | 31-924.2 | 0.003 kg |

Protective guard

Additional Information

- Please note that bigger minimum distances are necessary



Dimensions [mm]

| Product attribute | Dimension | Material | Colour | Part No. | Weight |
|---|------------|----------|-------------|---------------|----------|
|  <p>Protective guard</p> <p>narrow ends bent upwards, for button 18 x 24 mm with mounting cut-out Ø16 mm</p> | 18 x 26 mm | Brass | matt chrome | 01-926 | 0.011 kg |
|  <p>Protective guard</p> <p>broad sides bent upwards, for button 18 x 24 mm with mounting cut-out Ø16 mm</p> | 20 x 24 mm | Brass | matt chrome | 01-927 | 0.011 kg |

- 01
- 02
- 03
- 04
- 10
- 14
- 17
- 18
- 19
- 22
- 31
- 41
- 44
- 51
- 56
- 57
- 61
- 70
- 71
- 82
- 84
- 92
- 95
- 96
- 97
- 99
- ST

01 Accessories

01

Blind plug



Mounting cut-outs [mm]

| Dimension | Material | Colour | Part No. | Weight |
|--|----------|--------|-----------------|----------|
|  <p>Blind plug</p> | | | | |
| 18 x 18 mm | Plastic | black | 01-948.0 | 0.001 kg |
|  <p>Blind plug</p> | | | | |
| 18 x 24 mm | Plastic | black | 01-947.0 | 0.001 kg |
|  <p>Blind plug</p> | | | | |
| Ø 18 mm | Plastic | black | 01-949.0 | 0.001 kg |

Rear side



PCB plug-in base

Additional Information

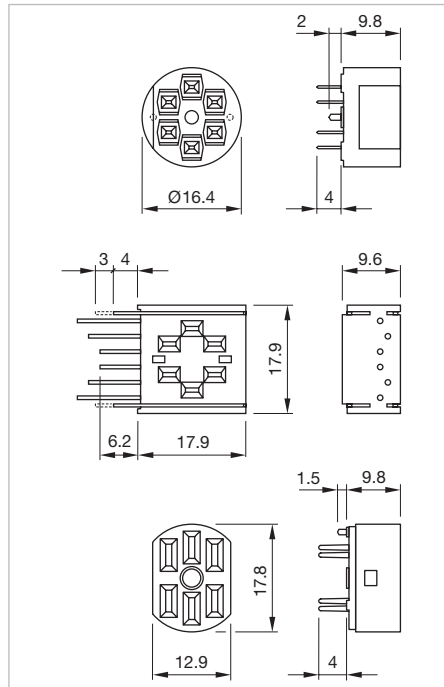
- PCB plug-in base pins right-angle: With the extendable mounting the distance between plug-in base and PCB can be varied up to 3 mm

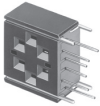

Dimensions [mm]

| Product attribute | Pins | Terminal | Part No. | Component layout | Weight |
|--|--------------|----------|---------------|------------------|----------|
|  <p>PCB plug-in base</p> | | | | | |
| for low level switching element | axial | PCB | 31-940 | 3 | 0.002 kg |
|  <p>PCB plug-in base</p> | | | | | |
| for low level switching element | right-angled | PCB | 31-941 | 1 | 0.004 kg |
|  <p>PCB plug-in base</p> | | | | | |
| for snap-action switching element 2.8 mm | axial | PCB | 31-942 | 2 | 0.002 kg |

The component layouts you will find from page 22

01
02
03
04
10
14
17
18
19
22
31
41
44
51
56
57
61
70
71
82
84
92
95
96
97
99
ST

01 Accessories

01

Flat receptacle

02

03

04

10

14

17

18

19

| Product attribute | Part No. | Weight |
|--|---------------|----------|
|  <p>Flat receptacle</p> | | |
| 2.0 x 0.5 mm plug-in terminal | 31-945 | 0.001 kg |
|  <p>Flat receptacle</p> | | |
| 2.8 x 0.5 mm plug-in terminal | 31-946 | 0.001 kg |

22

31

41

44

51

56

57

61

70

71

Insulation sleeve

| Product attribute | Part No. | Weight |
|--|---------------|----------|
|  <p>Insulation sleeve</p> | | |
| for flat receptacle 2.0 mm | 31-928 | 0.001 kg |
|  <p>Insulation sleeve</p> | | |
| for flat receptacle 2.8 mm | 31-929 | 0.001 kg |
|  <p>Insulation sleeve</p> | | |
| cover plug-in terminals for snap-action switching element 2.8 mm | 01-928 | 0.001 kg |

82

84

Terminal cover

92

95

96

97

99

ST

| Part No. | Weight |
|--|----------|
|  <p>Terminal cover for snap-action switching element 16</p> | |
| 01-929 | 0.010 kg |

Illumination

Single-LED, T6.8

Additional Information

- For LED element fitting information see «Application guidelines»
- Due to high surface temperatures, the series resistor must not be soldered directly to the terminals of the equipment (use a terminal plate)
- When using AC/DC types with AC operation, slight flickering can occur
- Luminous intensity data of the LEDs on direct voltage
- Electrical and optical data are measured at 25 °C
- The specified versions are built with a protection diode (half wave rectifier) in series and the LED
- Luminosity and wave length variations caused by LED manufacturing processes may cause slight differences regarding the illumination
- For supply voltages above 48 V, a voltage reduction element (external series resistor or transformer) must be used



Dimensions [mm]

| LED colour | Operating voltage | Operation current | Lumi. intensity | Dom. wavelength | Part No. | Weight |
|--|-------------------|-------------------|-----------------|-----------------|---------------------|----------|
|  <p>Single-LED</p> | | | | | | |
| Single-LED red | 6 VDC +10 % | 15 mA ±15 % | 350 mcd | 630 nm | 10-2106.3142 | 0.001 kg |
| | 12 VAC/DC +10 % | 7/14 mA ±15 % | 330 mcd | 630 nm | 10-2109.1062 | 0.001 kg |
| | 24 VAC/DC +10 % | 7/14 mA ±15 % | 330 mcd | 630 nm | 10-2112.1062 | 0.001 kg |
| | 28 VAC/DC +10 % | 7/14 mA ±15 % | 330 mcd | 630 nm | 10-2113.1062 | 0.001 kg |
| | 48 VAC/DC +10 % | 4/8 mA ±15 % | 200 mcd | 630 nm | 10-2119.1042 | 0.001 kg |
| Single-LED yellow | 6 VDC +10 % | 15 mA ±15 % | 300 mcd | 587 nm | 10-2106.3144 | 0.001 kg |
| | 12 VAC/DC +10 % | 7/14 mA ±15 % | 280 mcd | 587 nm | 10-2109.1064 | 0.001 kg |
| | 24 VAC/DC +10 % | 7/14 mA ±15 % | 280 mcd | 587 nm | 10-2112.1064 | 0.001 kg |
| | 28 VAC/DC +10 % | 7/14 mA ±15 % | 280 mcd | 587 nm | 10-2113.1064 | 0.001 kg |
| | 48 VAC/DC +10 % | 4/8 mA ±15 % | 180 mcd | 587 nm | 10-2119.1044 | 0.001 kg |
| Single-LED green | 6 VDC +10 % | 7 mA ±15 % | 1050 mcd | 525 nm | 10-2106.3145 | 0.001 kg |
| | 12 VAC/DC +10 % | 4/7 mA ±15 % | 1050 mcd | 525 nm | 10-2109.1065 | 0.001 kg |
| | 24 VAC/DC +10 % | 4/7 mA ±15 % | 1050 mcd | 525 nm | 10-2112.1065 | 0.001 kg |
| | 28 VAC/DC +10 % | 4/7 mA ±15 % | 1050 mcd | 525 nm | 10-2113.1065 | 0.001 kg |
| | 48 VAC/DC +10 % | 2/4 mA ±15 % | 600 mcd | 525 nm | 10-2119.1045 | 0.001 kg |
| Single-LED blue | 6 VDC +10 % | 15 mA ±15 % | 680 mcd | 470 nm | 10-2106.3146 | 0.001 kg |
| | 12 VAC/DC +10 % | 7/14 mA ±15 % | 650 mcd | 470 nm | 10-2109.1066 | 0.001 kg |
| | 24 VAC/DC +10 % | 7/14 mA ±15 % | 650 mcd | 470 nm | 10-2112.1066 | 0.001 kg |
| | 28 VAC/DC +10 % | 7/14 mA ±15 % | 650 mcd | 470 nm | 10-2113.1066 | 0.001 kg |
| | 48 VAC/DC +10 % | 4/8 mA ±15 % | 400 mcd | 470 nm | 10-2119.1046 | 0.001 kg |

01 Accessories

| LED colour | Operating voltage | Operation current | Lumi. intensity | Dom. wavelength | Part No. | Weight |
|------------------|-------------------|-------------------|-----------------|-----------------|---------------------|----------|
| Single-LED white | 6 VDC +10 % | 15 mA ±15 % | 750 mcd | x0.31/y0.32 nm | 10-2106.3149 | 0.001 kg |
| | 12 VAC/DC +10 % | 7/14 mA ±15 % | 700 mcd | x0.31/y0.32 nm | 10-2109.1069 | 0.001 kg |
| | 24 VAC/DC +10 % | 7/14 mA ±15 % | 700 mcd | x0.31/y0.32 nm | 10-2112.1069 | 0.001 kg |
| | 28 VAC/DC +10 % | 7/14 mA ±15 % | 700 mcd | x0.31/y0.32 nm | 10-2113.1069 | 0.001 kg |
| | 48 VAC/DC +10 % | 4/8 mA ±15 % | 400 mcd | x0.31/y0.32 nm | 10-2119.1049 | 0.001 kg |

Filament lamp, T6.8

| Operating voltage | Operation current | Part No. | Weight |
|--|-------------------|---------------------|----------|
|  <p>Filament lamp</p> | | | |
| 6 VAC/DC | 200 mA | 10-1106.1369 | 0.001 kg |
| 12 VAC/DC | 50 mA | 10-1109.1279 | 0.001 kg |
| 12 VAC/DC | 100 mA | 10-1109.1329 | 0.001 kg |
| 24 VAC/DC | 25 mA | 10-1112.1199 | 0.001 kg |
| 24 VAC/DC | 50 mA | 10-1112.1279 | 0.001 kg |
| 28 VAC/DC | 40 mA | 10-1113.1249 | 0.001 kg |
| 30 VAC/DC | 40 mA | 10-1114.1249 | 0.001 kg |
| 36 VAC/DC | 35 mA | 10-1116.1229 | 0.001 kg |
| 48 VAC/DC | 25 mA | 10-1119.1199 | 0.001 kg |

Series resistor

Additional Information

- For lamp voltage reduction
- Only for filament lamp 48 VAC, 25 mA
- Keep to the country specific safety instructions
- Due to high surface temperatures, the series resistor must not be soldered directly to the terminals of the equipment (use a terminal plate)

| Operating voltage | Resistance | Part No. | Weight |
|--|------------|-----------------|----------|
|  <p>Series resistor</p> | | | |
| 110 VAC | 2.7 kOhm | 02-904.0 | 0.003 kg |
| 125 VAC | 3.3 kOhm | 02-904.1 | 0.003 kg |
| 145 VAC | 4.7 kOhm | 02-904.3 | 0.003 kg |
| 240 VAC | 10 kOhm | 02-904.7 | 0.003 kg |

Terminal plate empty

Additional Information

- For fitting with series resistors

| Product attribute | Dimension | Part No. | Weight |
|--|--------------------|-----------------|----------|
|  <p>Terminal plate empty</p> | | | |
| 5 spaces | 62.5 x 60 x 15 mm | 02-912.1 | 0.025 kg |
| 10 spaces | 125 x 60 x 15 mm | 02-912.2 | 0.045 kg |
| 15 spaces | 187.6 x 60 x 15 mm | 02-912.3 | 0.090 kg |
| 20 spaces | 250 x 60 x 15 mm | 02-912.4 | 0.095 kg |

01
02
03
04
10
14
17
18
19
22
31
41
44
51
56
57
61
70
71
82
84
92
95
96
97
99
ST

01 Accessories

01
02
03
04
10
14
17
18
19
22
31
41
44
51
56
57
61
70
71
82
84
92
95
96
97
99
ST

Mounting

Lens remover

| Part No. | Weight |
|--|----------|
|  Lens remover | |
| 02-905 | 0.011 kg |

Lamp remover

Additional Information
▲ **Caution:** A switching process might be released when replacing the lamp

| Part No. | Weight |
|--|----------|
|  Lamp remover | |
| 02-906 | 0.002 kg |

Mounting tool

Additional Information
• For tightening or loosening of the fixing nut

| Part No. | Weight |
|---|----------|
|  Mounting tool | |
| 01-907 | 0.020 kg |

Dressing tool

Additional Information

- For aligning buttons

| Part No. | Weight |
|---|----------|
|  <p>Dressing tool</p> | |
| 01-906 | 0.030 kg |

01

02

03

04

10

14

17

18

19

22

31

41

44

51

56

57

61

70

71

82

84

92

95

96

97

99

ST

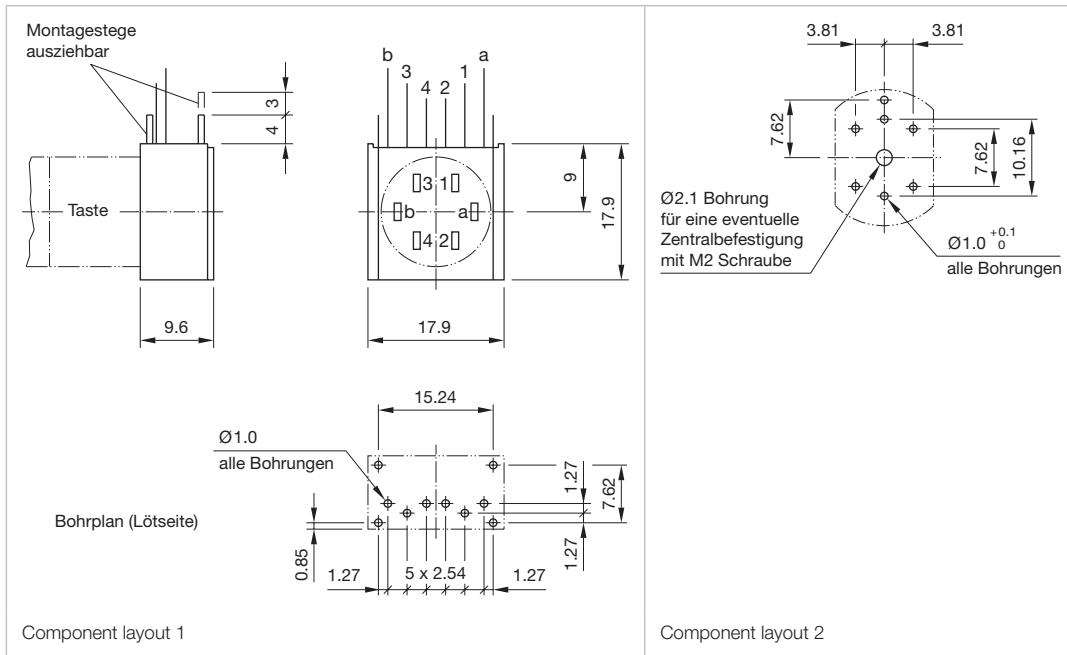

Actuator with snap-action switching element
Switching system

Self-cleaning, double-break, snap action switching system (with contact gap 2 x 0.5 mm).

1 Normally closed or 1 Normally open contact per element.

Snap-action switching elements with soldering terminals at the sides: Up to 4 switching element can be on a pushbutton (max. 4 Normally closed and 4 Normally open contacts).

Snap-action switching element with axial plug-in terminals 2.8 mm stachable, only 1 switching element can be on a pushbutton.

Material
Material of contact

Gold plated silver

Switch housing

Axial plug-in-/soldering terminal 2.8 mm:

Diallylphthalate (DAP), Polyamide (PA66), Polysulfone (PSU), heat-resistant and self-extinguishing

Soldering terminal: Ultramide (PA 6.6)

Actuator housing

Polyphenylene (PPO), self-extinguishing

Mechanical characteristics
Terminals

Snap-action switching element with tinned soldering terminals at the sides:

Max. wire diameter 2 wires à 1.2 mm

Max. wire cross-section of stranded cable 1 x 1 mm²

Snap-action switching element with axial plug-in terminals, which can also be used as soldering terminals: Plug-in terminal 2.8 x 0.5 mm

Soldering terminal:

Max. wire diameter 2 wire of 1 mm²

Max. wire cross-section of stranded cable 2 x 0.75 mm² or 1 x 1 mm²

Tightening torque

for fixing nut max. 25 Ncm

Actuating force

2 N ... 5.5 N, depending on the number of switching elements

Actuating travel

3 mm

Rebound time

≤5ms

Mechanical lifetime

Momentary action 2 million cycles of operation

Maintained action 1 million cycles of operation

Electrical characteristics
Standards

IEC 61058, EN 61058

Rated voltage

250 VAC/VDC

Rated current

5 A

Contact resistance

Starting value (initial) ≤50 mΩ

Conventional free air thermal current

5 A

The maximum current in continuous operation and at ambient temperature not exceeding the quoted maximum values.

Switch rating

250 VAC, 5 A (cosφ 1)

250 VAC, 3 A (cosφ 0,3)

Switch rating AC (cosφ 0,7)

| | | |
|---------|---------|---------|
| Voltage | 125 VAC | 250 VAC |
|---------|---------|---------|

| | | |
|---------|-----|-----|
| Current | 3 A | 2 A |
|---------|-----|-----|

Switch rating DC (inductive) L:R = 30 ms

| | | | | |
|---------|--------|--------|---------|---------|
| Voltage | 24 VDC | 60 VDC | 110 VDC | 220 VDC |
|---------|--------|--------|---------|---------|

| | | | | |
|---------|-----|-------|-------|-------|
| Current | 2 A | 0.7 A | 0.2 A | 0.1 A |
|---------|-----|-------|-------|-------|

Electric strength

2500 VAC, 50 Hz, 1 min. between all terminals and earth, as per IEC 60512-2-11

Protection class

II

Environmental conditions
Storage temperature

-40 °C ... +85 °C

Service temperature

-25 °C ... +55 °C

For indicators and illuminated pushbuttons mounted as a block, make sure the heat can escape freely.

Protection degree

Front P 40

IP 67 with front protective cap

Shock resistance

(Single impacts, semi-sinusoidal)

15 g for 11 ms, as per IEC 60512-4-3, IEC 60068-2-27

Vibration resistance

(sinusoidal)

10 g at 0-2000 Hz, amplitude 1.5 mm, as per IEC 60512-4-4, IEC 60068-2-6

01 Technical data

01

02

Approvals

03

Approbations

CB (IEC 61058)

CSA

04

ENEC (EN 61058)

Germanischer Lloyd

10

UL

14

Declaration of conformity

CE

17

Actuator with low level switching element

18

Switching system

This low level switching element was designed for switching low powers in electronic circuits. The mechanism assures reliable switching of loads ranging from a few μA / μV up to 100 mA / 42 VAC/DC.

19

Single-break momentary contact, as normally open or normally closed with 4 independent points of contact. 2 momentary contacts per switching element; combination of normally open and normally closed is possible.

22

Special features are the long life, extremely short rebound time and stable contact resistance.

31

41

44

Material

51

Material of contact

Gold plated

56

Switch housing

Polysulfone (PSU), heat-resistant and self-extinguishing

57

Actuator housing

Polyphenylene (PPO), self-extinguishing

61

70

Mechanical characteristics

71

Terminals

The universal terminals permit these units to be mounted on printed circuit boards (PCB). These terminals can also be used as soldering or plug-in terminals.

82

For these terminals we can also supply a plug-in base which, when soldered on to the board, enables the switch to be plugged in.

84

92

Soldering terminal:

Max. wire diameter 2 wires à 0.8 mm

95

Max. wire cross-section of stranded cable 1x 0.75 mm²

96

Plug-in terminal: 2.0 x 0.5 mm

97

Actuating force

3 N ... 3,5 N

99

Actuating travel

3 mm

ST

Rebound time

Typ. <100 μs

ST

Mechanical lifetime

Momentary action 5 million cycles of operation

Maintained action 1 million cycles of operation

Electrical characteristics

Standards

EN 61058

Contact resistance

Starting value (initial) $\leq 50 \text{ m}\Omega$

Switch rating

10 μA , 100 μV to 100 mA at 42 VAC/VDC

Electric strength

2500 VAC, 50 Hz, 1 min. between all terminals and earth, as per IEC 60512-2-11

Protection class

II

Environmental conditions

Storage temperature

-40 °C ... +85 °C

Service temperature

-25 °C ... +55 °C

For indicators and illuminated pushbuttons mounted as a block, make sure the heat can escape freely.

Protection degree

Front P 40

IP 67 with front protective cap

Shock resistance

(Single impacts, semi-sinusoidal)

15 g for 11 ms, as per IEC 60512-4-3, IEC 60068-2-27

Climate resistance

Standard condition, as per IEC 60068-2-3 and 2-30

Changing condition, as per IEC 60068-2-14 and 2-33

EAO reserves the right to alter specifications without further notice.

General notes

1. Engraving

In addition to the most commonly used world languages, in DIN1451-3 close spacing, other typefaces are available as Scandinavian, Slavic, Greek, Russian and Polish. Red, blue and black lenses are filled with white colour. Other colour lenses are filled in black. Standard height of letters is 2mm. If the height is not specified, we will supply 2mm engraved letters.

2. Hot stamping

For larger series it is worth considering markings by means of hot stamping. We will pleased to advise you. For letters and figures, typefaces with 2.5mm, 3mm and 4mm are available.

3. Film inserts

Instead of using engraving the lenses can be fitted with transparent film inserts, as an alternative. For this purpose, though, it is advisable to use transparent lenses. In the case of use of a smoke-black lens the fitted film becomes readable only if the lamp is on. To insert the film, the feet of the lens holder have to be pushed together far enough to enable the lens to be lift off easily. The film thickness is 0.2mm.

Important: Consider pushbutton mounting orientation before specifying engraving characters!

All dimensions in mm

| Front size (Lens) | Film insert max. size | Height of letters h | Number of lines | Number of capital letters per line (target value) | Number of small letters per line (target value) | Image | | |
|-----------------------|-----------------------|---------------------|-----------------|---|---|-------|---|----|
| 18 x 18 (12.8 x 12.8) | 10.2 x 10.2 | 2.5 | 3 | 6-7 | 7 | B3 | | |
| | | 3.0 | 2 | 5-6 | 6 | B3 | | |
| | | 4.0 | 2 | 4 | 4 | B3 | | |
| | | 5.0 | 1 | 3 | 3-4 | B3 | | |
| | | 6.0 | 1 | 2-3 | 3 | B3 | | |
| | | 8.0 | 1 | 2 | 2 | B3 | | |
| 18 x 24 (12.8 x 18.8) | 10.2 x 16.2 | 2.5 | 3 | 10 | 10-11 | B1 | | |
| | | 2.5 | 4 | 6-7 | 7 | B2 | | |
| | | 3.0 | 2 | 8-9 | 9 | B3 | | |
| | | 3.0 | 4 | 5-6 | 6 | B4 | | |
| | | 4.0 | 2 | 6 | 6-7 | B2 | | |
| | | 4.0 | 3 | 4 | 4 | B1 | | |
| | | 5.0 | 1 | 5 | 5-6 | B2 | | |
| | | 5.0 | 2 | 3 | 3-4 | B1 | | |
| | | 6.0 | 1 | 4 | 4-5 | B2 | | |
| | | 6.0 | 1 | 2-3 | 3 | B1 | | |
| | | 8.0 | 1 | 3 | 3-4 | B2 | | |
| | | 8.0 | 1 | 2 | 2 | B2 | | |
| | | Ø 18 (Ø 15.8) | Ø 12.8 | 2.5 | 3 | 6 | 6 | B4 |
| | | | | 3.0 | 2 | 5 | 6 | B4 |
| 4.0 | 2 | | | 3 | 4 | B4 | | |
| 5.0 | 1 | | | 2 | 3 | B4 | | |
| 6.0 | 1 | | | 2 | 2 | B4 | | |
| 8.0 | 1 | | | 2 | 2 | B4 | | |



01 Application guidelines

01 Suppressor circuits

When switching inductive loads such as relays, DC motors, and DC solenoids, it is always important to absorb surges (e.g. with a diode) to protect the contacts. When these inductive loads are switched off, a counter emf can severely damage switch contacts and greatly shorten lifetime.

Fig. 1 shows an inductive load with a free-wheeling diode connected in parallel. This free-wheeling diode provides a path for the inductor current to flow when the current is interrupted by the switch. Without this free-wheeling diode, the voltage across the coil will be limited only by dielectric breakdown voltages of the circuit or parasitic elements of the coil. This voltage can be kilovolts in amplitude even when nominal circuit voltages are low (e.g. 12VDC) see Fig. 2.

The free-wheeling diode should be chosen so that the reverse breakdown voltage is greater than the voltage driving the inductive load. The DC blocking voltage (V_R) of the free-wheeling diode can be found in the datasheet of a diode. The forward current should be equal or greater than the maximum current flowing through the load.

To get an efficient protection, the free-wheeling diode must be connected as close as possible to the inductive load!

Switching with inductive load
Fig. 1



Counter EMF
over load without free-wheeling diode
Fig. 2



LED polarity

When fitting the LED elements the polarity has to correspond with the respective terminals, (+) goes to +.



Diode element for lamp check

When indicators and illuminated pushbuttons equipped with diodes, the user is able to perform a lamp check or wire an alarm circuit simply with a considerable saving of space.

Lamp check



Lamp check with blocking diodes



Alarm circuit from fault annunciation system



Lamp check and alarm circuit



Lamp check and alarm circuit with only one diode and AC voltage



LK = Lamp control

| |
|----|
| 01 |
| 02 |
| 03 |
| 04 |
| 10 |
| 14 |
| 17 |
| 18 |
| 19 |
| 22 |
| 31 |
| 41 |
| 44 |
| 51 |
| 56 |
| 57 |
| 61 |
| 70 |
| 71 |
| 82 |
| 84 |
| 92 |
| 95 |
| 96 |
| 97 |
| 99 |
| ST |

01 Index

01

Index from Part No.

| Part No. | Page | Part No. | Page | Part No. | Page |
|-------------|------|-------------|------|--------------|------|
| 01-030.002 | 5 | 01-709.0292 | 6 | 01-983.5 | 11 |
| 01-030.005 | 5 | 01-710.0292 | 6 | 01-983.6 | 11 |
| 01-031.006 | 5 | 01-711.0292 | 6 | 01-983.7 | 11 |
| 01-040.002 | 4 | 01-712.0292 | 7 | 01-985.2 | 10 |
| 01-040.005 | 4 | 01-713.0292 | 7 | 01-985.3 | 10 |
| 01-041.006 | 4 | 01-714.0292 | 7 | 01-985.4 | 10 |
| 01-050.002 | 4 | 01-715.0292 | 7 | 01-985.5 | 10 |
| 01-050.005 | 4 | 01-716.0292 | 7 | 01-985.6 | 10 |
| 01-051.006 | 4 | 01-717.0292 | 6 | 01-985.7 | 10 |
| 01-121.022 | 7 | 01-718.0292 | 6 | 02-904.0 | 18 |
| 01-121.0252 | 7 | 01-719.0292 | 6 | 02-904.1 | 18 |
| 01-122.0252 | 7 | 01-720.0292 | 7 | 02-904.3 | 18 |
| 01-123.0252 | 7 | 01-741.006 | 5 | 02-904.7 | 18 |
| 01-124.0252 | 7 | 01-742.006 | 5 | 02-905 | 20 |
| 01-131.022 | 8 | 01-743.0292 | 8 | 02-906 | 20 |
| 01-131.0252 | 8 | 01-744.0292 | 8 | 02-912.1 | 19 |
| 01-132.0252 | 8 | 01-745.0292 | 8 | 02-912.2 | 19 |
| 01-133.0252 | 8 | 01-746.0292 | 8 | 02-912.3 | 19 |
| 01-134.0252 | 8 | 01-747.0292 | 8 | 02-912.4 | 19 |
| 01-151.022 | 6 | 01-748.0292 | 8 | 10-1106.1369 | 18 |
| 01-151.0252 | 6 | 01-749.0292 | 8 | 10-1109.1279 | 18 |
| 01-152.0252 | 7 | 01-750.0292 | 8 | 10-1109.1329 | 18 |
| 01-153.0252 | 7 | 01-901.0 | 10 | 10-1112.1199 | 18 |
| 01-154.0252 | 7 | 01-901.2 | 10 | 10-1112.1279 | 18 |
| 01-261.022 | 7 | 01-901.3 | 10 | 10-1113.1249 | 18 |
| 01-261.0252 | 7 | 01-901.4 | 10 | 10-1114.1249 | 18 |
| 01-262.0252 | 7 | 01-901.5 | 10 | 10-1116.1229 | 18 |
| 01-263.0252 | 7 | 01-901.6 | 10 | 10-1119.1199 | 18 |
| 01-264.0252 | 7 | 01-901.8 | 10 | 10-2106.3142 | 17 |
| 01-271.022 | 8 | 01-901.9 | 10 | 10-2106.3144 | 17 |
| 01-271.0252 | 8 | 01-906 | 21 | 10-2106.3145 | 17 |
| 01-272.0252 | 8 | 01-907 | 20 | 10-2106.3146 | 17 |
| 01-273.0252 | 8 | 01-925 | 12 | 10-2106.3149 | 18 |
| 01-274.0252 | 8 | 01-926 | 13 | 10-2109.1062 | 17 |
| 01-281.022 | 6 | 01-927 | 13 | 10-2109.1064 | 17 |
| 01-281.0252 | 6 | 01-928 | 16 | 10-2109.1065 | 17 |
| 01-282.0252 | 7 | 01-929 | 16 | 10-2109.1066 | 17 |
| 01-283.0252 | 7 | 01-931.0 | 11 | 10-2109.1069 | 18 |
| 01-284.0252 | 7 | 01-931.2 | 11 | 10-2112.1062 | 17 |
| 01-421.036 | 7 | 01-931.3 | 11 | 10-2112.1064 | 17 |
| 01-422.036 | 7 | 01-931.4 | 11 | 10-2112.1065 | 17 |
| 01-423.036 | 7 | 01-931.5 | 11 | 10-2112.1066 | 17 |
| 01-425.036 | 7 | 01-931.6 | 11 | 10-2112.1069 | 18 |
| 01-426.036 | 7 | 01-931.8 | 11 | 10-2113.1062 | 17 |
| 01-431.036 | 8 | 01-931.9 | 11 | 10-2113.1064 | 17 |
| 01-432.036 | 8 | 01-947.0 | 14 | 10-2113.1065 | 17 |
| 01-433.036 | 8 | 01-948.0 | 14 | 10-2113.1066 | 17 |
| 01-435.036 | 8 | 01-949.0 | 14 | 10-2113.1069 | 18 |
| 01-436.036 | 8 | 01-951.0 | 10 | 10-2119.1042 | 17 |
| 01-451.036 | 6 | 01-951.2 | 10 | 10-2119.1044 | 17 |
| 01-452.036 | 6 | 01-951.3 | 10 | 10-2119.1045 | 17 |
| 01-453.036 | 6 | 01-951.4 | 10 | 10-2119.1046 | 17 |
| 01-455.036 | 6 | 01-951.5 | 10 | 10-2119.1049 | 18 |
| 01-456.036 | 6 | 01-951.6 | 10 | 31-920 | 12 |
| 01-461.036 | 7 | 01-951.8 | 10 | 31-923 | 12 |
| 01-462.036 | 7 | 01-951.9 | 10 | 31-924.2 | 12 |
| 01-463.036 | 7 | 01-972.2 | 10 | 31-928 | 16 |
| 01-465.036 | 7 | 01-972.4 | 10 | 31-929 | 16 |
| 01-466.036 | 7 | 01-972.5 | 10 | 31-940 | 15 |
| 01-471.036 | 8 | 01-972.7 | 10 | 31-941 | 15 |
| 01-472.036 | 8 | 01-973.2 | 11 | 31-942 | 15 |
| 01-473.036 | 8 | 01-973.4 | 11 | 31-945 | 16 |
| 01-475.036 | 8 | 01-973.5 | 11 | 31-946 | 16 |
| 01-476.036 | 8 | 01-973.7 | 11 | | |
| 01-481.036 | 6 | 01-975.2 | 10 | | |
| 01-482.036 | 6 | 01-975.4 | 10 | | |
| 01-483.036 | 6 | 01-975.5 | 10 | | |
| 01-485.036 | 6 | 01-975.7 | 10 | | |
| 01-486.036 | 6 | 01-982.2 | 10 | | |
| 01-701.006 | 4 | 01-982.3 | 10 | | |
| 01-702.006 | 4 | 01-982.4 | 10 | | |
| 01-703.006 | 4 | 01-982.5 | 10 | | |
| 01-704.006 | 4 | 01-982.6 | 10 | | |
| 01-705.0292 | 7 | 01-982.7 | 10 | | |
| 01-706.0292 | 7 | 01-983.2 | 11 | | |
| 01-707.0292 | 7 | 01-983.3 | 11 | | |
| 01-708.0292 | 7 | 01-983.4 | 11 | | |

Компания «Океан Электроники» предлагает заключение долгосрочных отношений при поставках импортных электронных компонентов на взаимовыгодных условиях!

Наши преимущества:

- Поставка оригинальных импортных электронных компонентов напрямую с производств Америки, Европы и Азии, а так же с крупнейших складов мира;
- Широкая линейка поставок активных и пассивных импортных электронных компонентов (более 30 млн. наименований);
- Поставка сложных, дефицитных, либо снятых с производства позиций;
- Оперативные сроки поставки под заказ (от 5 рабочих дней);
- Экспресс доставка в любую точку России;
- Помощь Конструкторского Отдела и консультации квалифицированных инженеров;
- Техническая поддержка проекта, помощь в подборе аналогов, поставка прототипов;
- Поставка электронных компонентов под контролем ВП;
- Система менеджмента качества сертифицирована по Международному стандарту ISO 9001;
- При необходимости вся продукция военного и аэрокосмического назначения проходит испытания и сертификацию в лаборатории (по согласованию с заказчиком);
- Поставка специализированных компонентов военного и аэрокосмического уровня качества (Xilinx, Altera, Analog Devices, Intersil, Interpoint, Microsemi, Actel, Aeroflex, Peregrine, VPT, Syfer, Eurofarad, Texas Instruments, MS Kennedy, Miteq, Cobham, E2V, MA-COM, Hittite, Mini-Circuits, General Dynamics и др.);

Компания «Океан Электроники» является официальным дистрибьютором и эксклюзивным представителем в России одного из крупнейших производителей разъемов военного и аэрокосмического назначения «JONHON», а так же официальным дистрибьютором и эксклюзивным представителем в России производителя высокотехнологичных и надежных решений для передачи СВЧ сигналов «FORSTAR».



JONHON

«JONHON» (основан в 1970 г.)

Разъемы специального, военного и аэрокосмического назначения:

(Применяются в военной, авиационной, аэрокосмической, морской, железнодорожной, горно- и нефтедобывающей отраслях промышленности)

«FORSTAR» (основан в 1998 г.)

ВЧ соединители, коаксиальные кабели, кабельные сборки и микроволновые компоненты:

(Применяются в телекоммуникациях гражданского и специального назначения, в средствах связи, РЛС, а так же военной, авиационной и аэрокосмической отраслях промышленности).



Телефон: 8 (812) 309-75-97 (многоканальный)

Факс: 8 (812) 320-03-32

Электронная почта: ocean@oceanchips.ru

Web: <http://oceanchips.ru/>

Адрес: 198099, г. Санкт-Петербург, ул. Калинина, д. 2, корп. 4, лит. А