

**Low Power Audio Jack Detector with SEND/END Detection in Miniaturized Package**

NEW PRODUCT

**Description**

The AZV5002 is a low power and cost effective headset detection IC with a comparator with internal hysteresis, OR gate, and N-channel MOSFET integrated designed to detect the assertion of a headset with a microphone.

Pullup resistors for the detection pins are internalized, a built in resistor divider provides the reference voltage for detecting the left audio channel. The logic low output of the OR gate indicates the headset has been connected properly.

The AZV5002 is available in miniaturized package, U-QFN1418-10 which helps reduce the space needed on PCB boards.

**Features**

- Low Supply Current: 5µA (Typical) @ V<sub>DD</sub> = 1.8V
- Supply Voltage Range: 1.6~5.5V
- Comparator, OR Gate, N-Channel MOSFET Integrated
- Open Drain Output for MIC Pin
- U-QFN1418-10: Available in "Green" Molding Compound (No Br. Sb.)
- **Totally Lead-Free & Fully RoHS Compliant (Notes 1 & 2)**
- **Halogen and Antimony Free. "Green" Device(Note 3)**

**Pin Assignments**

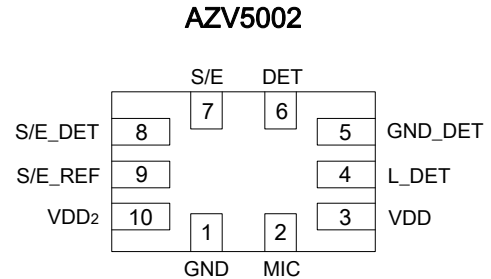

**Top View (U-QFN1418-10)**

Fig. 1

**Applications**

- Mobile Phones
- Tablet
- Battery Powered Devices
- Alarm and Security Systems

Notes: 1. No purposely added lead. Fully EU Directive 2002/95/EC (RoHS) & 2011/65/EU (RoHS 2) compliant.  
 2. See [http://www.diodes.com/quality/lead\\_free.html](http://www.diodes.com/quality/lead_free.html) for more information about Diodes Incorporated's definitions of Halogen- and Antimony-free, "Green" and Lead-free.  
 3. Halogen- and Antimony-free "Green" products are defined as those which contain <900ppm bromine, <900ppm chlorine (<1500ppm total Br + Cl) and <1000ppm antimony compounds.

**Typical Applications Circuit**

NEW PRODUCT

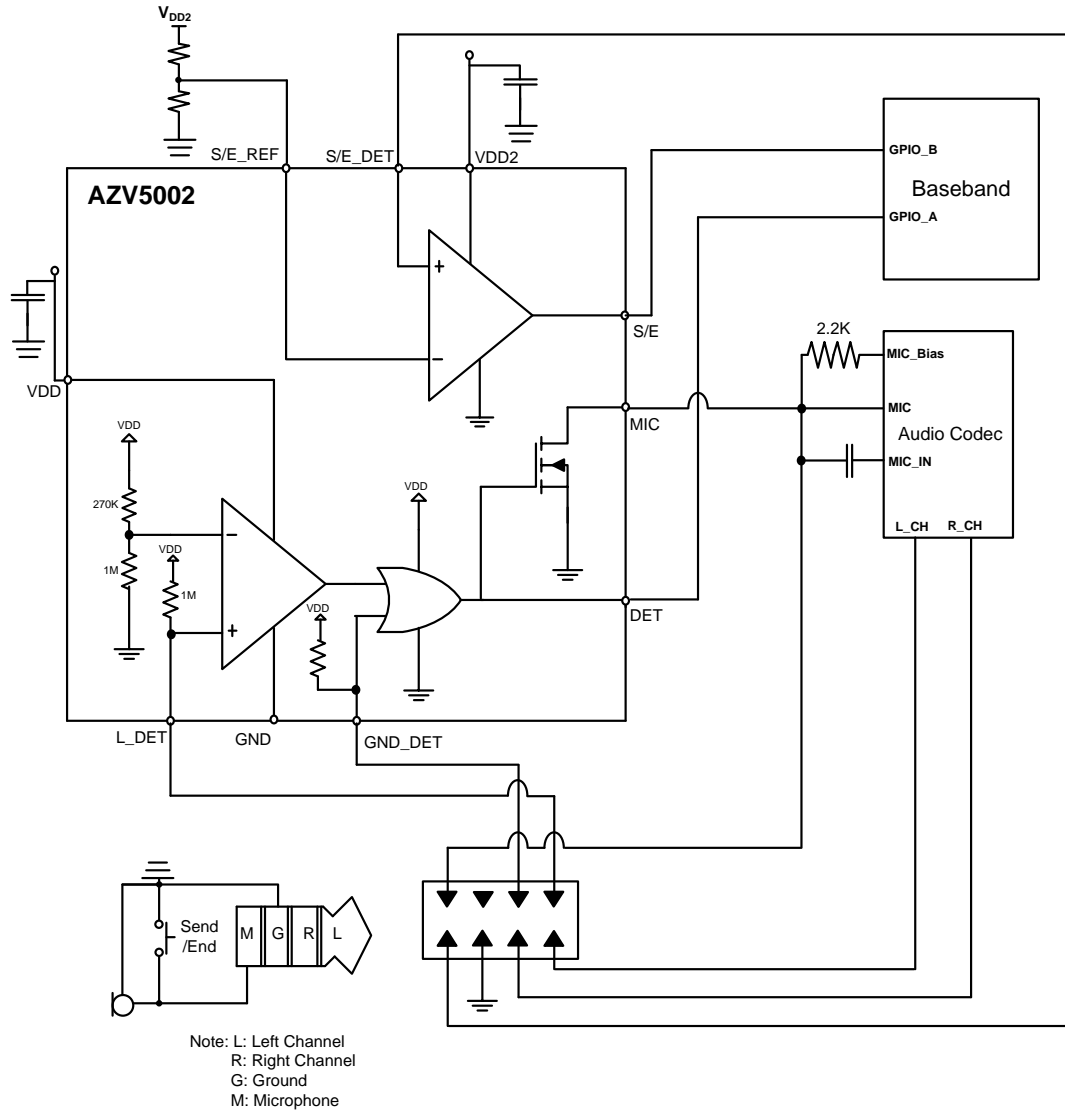

Fig. 2

**Output Logic**

Inputs		Outputs		Headset
L_DET	GND_DET	DET	MIC	
0	0	0	1 (External Pull-Up)	Detected
0	1	1	0	Not Detected
1	0	1	0	Not Detected
1	1	1	0	Not Detected

**Pin Descriptions**

AZV5002			
Pin Name	Pin Number	Type	Function
GND	1	Power	Connects to system ground.
MIC	2	Output	MIC output pin with open drain output type. When the headset is asserted, then MIC is pulled up to the MIC bias voltage with a pull-up resistor. When the headset is not asserted, then MIC is pulled low.
VDD	3	Power	System power supply. A bypass capacitor of 0.1μF is recommended as close as possible to the pin.
L_DET	4	Input	Left channel detection pin. Connect to audio jack L_DET, this pin is pulled low when the headset is present.
GND_DET	5	Input	Ground pin detection pin. Connect to audio jack GND_DET, this pin is pulled low when the headset is present.
DET	6	Output	DET is a logic output that indicates whether the headset has been properly inserted.
S/E	7	Output	S/E is an output port indicates SEND/END button condition. When SEND/END button press is detected, S/E output is at low level.
S/E_DET	8	Input	Non-inverting input of the comparator detects whether the SEND/END button has been pressed.
S/E_REF	9	Input	Inverting input of the comparator to set a voltage reference with an external resistor divider.
VDD2	10	Power	System power supply for the S/E detection comparator. A bypass capacitor of 0.1 μF is recommended as close as possible to the pin.

**Functional Block Diagram**

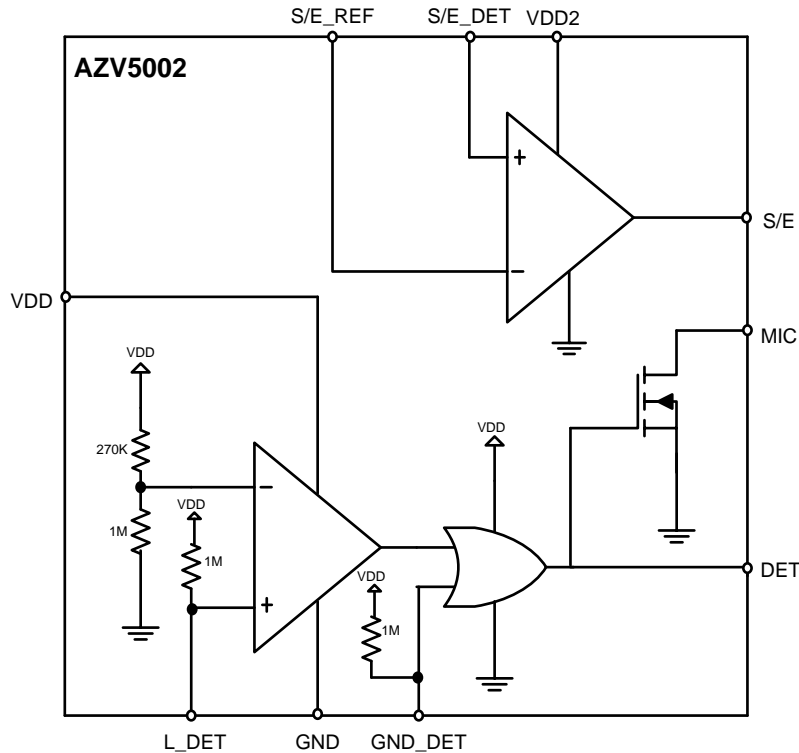

Fig.3

**Absolute Maximum Ratings** (@T<sub>A</sub> = +25°C, unless otherwise specified.)

Symbol	Parameter	Min	Max	Unit
V <sub>DD</sub>	Supply Voltage	0	6	V
V <sub>DD2</sub>				
V <sub>IN</sub>	Input Pin Voltage Range (L_DET, GND_DET)	-0.1	V <sub>DD</sub> +0.1	V
V <sub>IN</sub>	I Input Pin Voltage Range (S/E_REF, S/E_DET)	-0.1	V <sub>DD2</sub> +0.1	V
V <sub>MIC</sub>	MIC Output Pin Voltage Range	0	6	V
I <sub>MIC</sub>	Max Current on MIC Pin	-	2	mA
T <sub>J</sub>	Junction Temperature	-40	+150	°C
T <sub>STG</sub>	Storage Temperature	-65	+150	°C
ESD	HBM	8000		V
	MM	200		V
I <sub>LATCH-UP</sub>	Latch-Up Current (Note 4)	800		mA

Note 4: Latch-up test at V<sub>DD</sub>/V<sub>DD2</sub> = 3V condition.

**Recommended Operating Ratings** (@T<sub>A</sub> = +25°C, unless otherwise specified.)

Symbol	Parameter	Condition	Min	Max	Unit
V <sub>DD</sub>	Power Supply Voltage	Headset Detection Circuit	1.6	5.5	V
V <sub>DD2</sub>		S/E Detection Comparator	1.6	5.5	V
V <sub>IN</sub>	Input Voltage	L_DET, GND_DET	0	V <sub>DD</sub>	V
		S/E_DET, S/E_REF	0	V <sub>DD2</sub>	V
V <sub>MIC.BIAS</sub>	MIC Bias Voltage	-	0	5.5	V
T <sub>A</sub>	Ambient Temperature	-	-40	+85	°C
T <sub>J</sub>	Junction Temperature	-	-40	+125	°C

**Electrical Characteristics** (Typical Values are referenced to  $T_A = +25^\circ\text{C}$ ,  $V_{DD} = 1.8\text{V}$ ,  $V_{DD2} = 2.1\text{V}$ , unless otherwise noted. Min/max values apply from  $T_A = -40$  to  $+85^\circ\text{C}$ , unless otherwise noted.)

Symbol	Parameter	Conditions	Min	Typ	Max	Unit
$I_{DD}$	Headset Detection Circuit	$V_{GND-Det} = 1.8\text{V}$ , $V_{L-Det} = 1.8\text{V}$	-	5	8	$\mu\text{A}$
$I_{DD2}$	S/E Detection Comparator	$V_{DD} = 1.8\text{V}$ , $V_{DD2} = 2.1\text{V}$	-	4	6	$\mu\text{A}$
<b>Input Characteristics of L_Det</b>						
$V_{IH}$	Input Logic High	$V_{DD} = 1.8\text{V}$	1.5	-	-	V
$V_{IL}$	Input Logic Low	$V_{DD} = 1.8\text{V}$	-	-	1.33	V
$t_{pLH}$	Propagation Delay to DET_ $t_{pLH}$	$C_{OUT} = 15\text{pF}$ , $V_{GND-Det} = 0\text{V}$ , $V_{L-Det} = 1.31\sim 1.52\text{V}$	-	250	-	ns
$t_{pHL}$	Propagation Delay to DET_ $t_{pHL}$	$C_{OUT} = 15\text{pF}$ , $V_{GND-Det} = 0\text{V}$ , $V_{L-Det} = 1.31\sim 1.52\text{V}$	-	450	-	ns
$C_{IN}$	Input Capacitance	$f = 1\text{MHz}$	-	3	-	pF
$I_{IH}$	Low Voltage Input Leakage	$V_{L-Det} = 0\text{V}$	-	0.8	-	$\mu\text{A}$
$I_{IL}$	High Voltage Input Leakage	$V_{L-Det} = 1.8\text{V}$	-	2.4	-	nA
<b>Input Characteristics of GND_Det</b>						
$V_{IH}$	Input Logic High	$V_{DD} = 1.8\text{V}$	1.17	-	-	V
$V_{IL}$	Input Logic Low	$V_{DD} = 1.8\text{V}$	-	-	0.63	V
$t_{pLH}$	Propagation Delay to DET_ $t_{pLH}$	$C_{OUT} = 15\text{pF}$ , $V_{L-Det} = 0\text{V}$ , $V_{GND-Det} = 0\sim 1.8\text{V}$ , $R_L = 1\text{M}\Omega$	-	10	-	ns
$t_{pHL}$	Propagation Delay to DET_ $t_{pHL}$	$C_{OUT} = 15\text{pF}$ , $V_{L-Det} = 0\text{V}$ , $V_{GND-Det} = 0\sim 1.8\text{V}$ , $R_L = 1\text{M}\Omega$	-	10	-	ns
$C_{IN}$	Input Capacitance	$f = 1\text{MHz}$	-	3	-	pF
$I_{IH}$	Low Voltage Input Leakage	$V_{L-Det} = 0\text{V}$	-	0.8	-	$\mu\text{A}$
$I_{IL}$	High Voltage Input Leakage	$V_{L-Det} = 1.8\text{V}$	-	2.7	-	nA
<b>Output Characteristics of DET</b>						
$V_{OH}$	Voltage Output High	$V_{DD} = 1.8\text{V}$ , $I_{OH} = -0.1\text{mA}$	1.6	-	-	V
$V_{OL}$	Voltage Output Low	$V_{DD} = 1.8\text{V}$ , $I_{OL} = 0.1\text{mA}$	-	-	0.1	V
$T_{RISE}$	Rise Time	$C_{OUT} = 15\text{pF}$ , $R_L = 1\text{M}\Omega$	-	5	-	ns
$T_{FALL}$	Fall Time	$C_{OUT} = 15\text{pF}$ , $R_L = 1\text{M}\Omega$	-	5	-	ns
<b>Input Characteristics of S/E_REF &amp; S/E_DET</b>						
$t_{pLH}$	Propagation Delay to S/E_ $t_{pLH}$	$C_{OUT} = 15\text{pF}$ , $V_{CM} = \text{mid-supply}$ , 100 mV overdrive	-	300	-	ns
$t_{pHL}$	Propagation Delay to S/E_ $t_{pHL}$	$C_{OUT} = 15\text{pF}$ , $V_{CM} = \text{mid-supply}$ , 100 mV overdrive	-	200	-	ns
$I_{IL}$	Input Leakage	$V_{CM} = 0.9\text{V}$	-	150	-	pA

**Electrical Characteristics** (Cont. Typical Values are referenced to  $T_A = +25^\circ\text{C}$ ,  $V_{DD} = 1.8\text{V}$ ,  $V_{DD2} = 2.1\text{V}$ , unless otherwise noted. Min/max values apply from  $T_A = -40$  to  $+85^\circ\text{C}$ , unless otherwise noted.)

Symbol	Parameter	Conditions	Min	Typ	Max	Unit
$C_{IN}$	Input Capacitance	S/E_DET, $f = 1\text{MHz}$	-	3	-	$\mu\text{F}$
		S/E_REF, $f = 1\text{MHz}$	-	11	-	
<b>Output Characteristics of S/E</b>						
$V_{OH}$	Voltage Output High	$V_{DD} = 1.8\text{V}$ , $I_{OH} = -0.1\text{mA}$	1.9	-	-	V
$V_{OL}$	Voltage Output Low	$V_{DD} = 1.8\text{V}$ , $I_{OH} = 0.1\text{mA}$	-	-	0.1	V
$T_{RISE}$	Rise Time	$C_{OUT} = 15\text{pF}$ , $R_L = 1\text{M}\Omega$	-	10	-	ns
$T_{FALL}$	Fall Time	$C_{OUT} = 15\text{pF}$ , $R_L = 1\text{M}\Omega$	-	10	-	ns
<b>Characteristics of MIC</b>						
$t_{pLH}$	Propagation Delay to MIC_ $t_{pLH}$	$C_{OUT} = 15\text{pF}$ , $V_{GND-Det} = 0$ , $V_{L\_Det} = 1.31\text{V}$ to $1.52\text{V}$ $R_{PU} = 2.2\text{K}$ , MIC Bias = $2.3\text{V}$	-	1000	-	ns
$t_{pHL}$	Propagation Delay to MIC_ $t_{pHL}$	$C_{OUT} = 15\text{pF}$ , $V_{GND-Det} = 0$ , $V_{L\_Det} = 1.31\text{V}$ to $1.52\text{V}$ $R_{PU} = 2.2\text{K}$ , MIC Bias = $2.3\text{V}$	-	350	-	ns
$R_{DS(ON)}$	Drain-Source On Resistor of NMOS	$I_{MIC} = 1\text{mA}$	-	0.55	1.3	$\Omega$

**Performance Characteristics** (Typical Values are referenced to  $V_{DD} = 1.8V$ ,  $V_{DD2} = 2.1V$ , unless otherwise noted.)

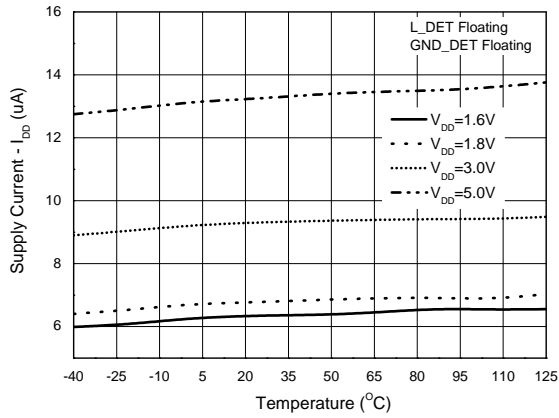

Supply Current vs. Temperature

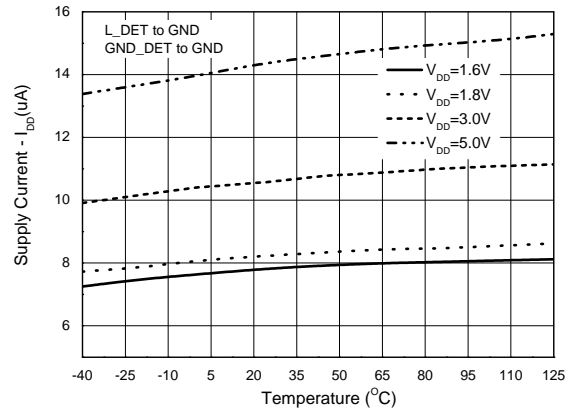

Supply Current vs. Temperature

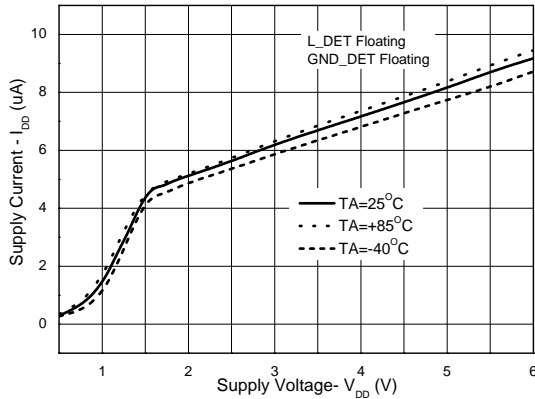

Supply Current vs. Supply Voltage

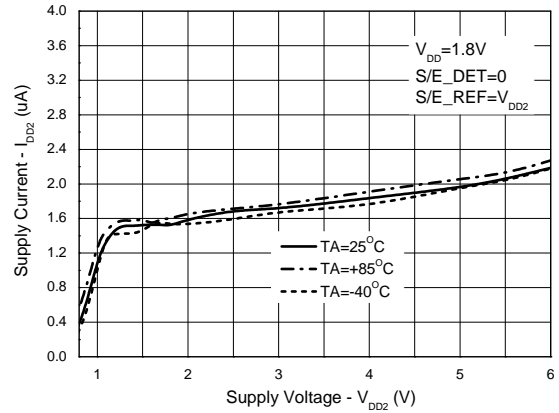

Supply Current vs. Supply Voltage

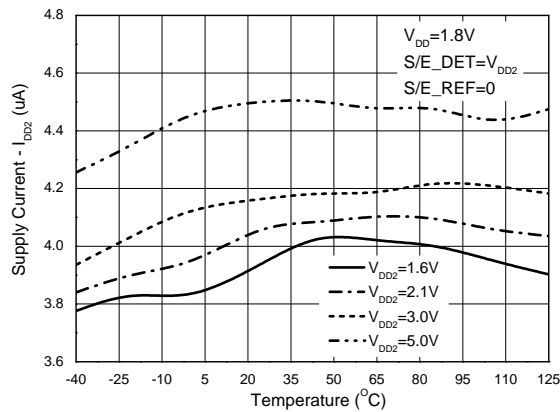

Supply Current vs. Temperature

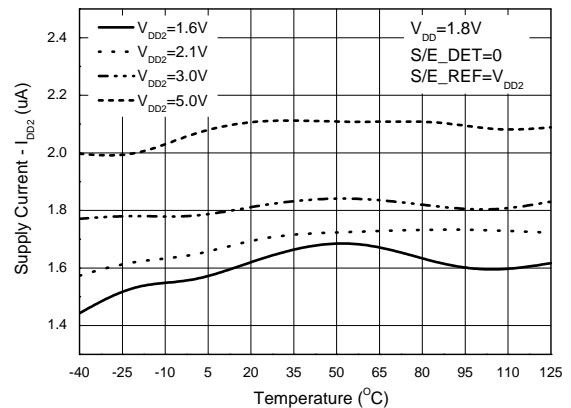

Supply Current vs. Temperature

NEW PRODUCT

**Performance Characteristics** (Cont.) (Typical Values are referenced to  $V_{DD} = 1.8V$ ,  $V_{DD2} = 2.1V$ , unless otherwise noted.)

NEW PRODUCT

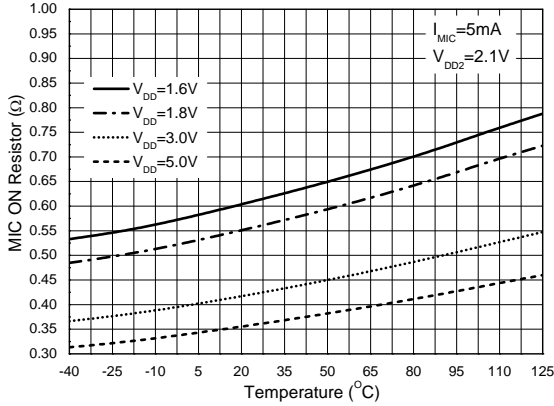

MIC ON Resistor vs. Temperature

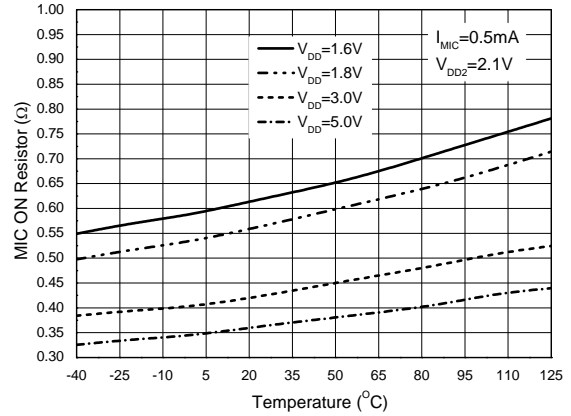

MIC ON Resistor vs. Temperature

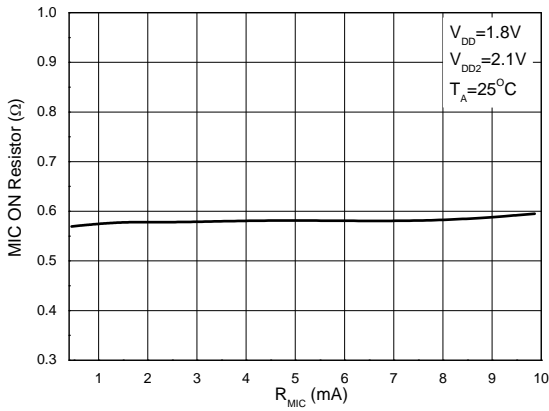

MIC ON Resistor vs. Drain Current

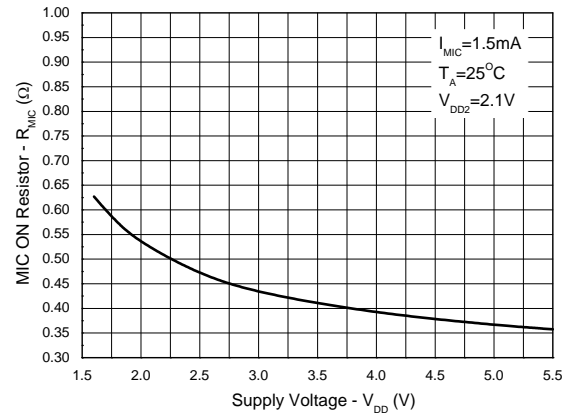

MIC ON Resistor vs. Supply Voltage

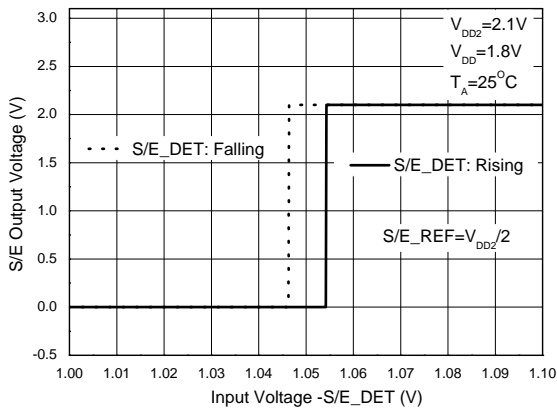

S/E Comparator Input Internal Hysteresis Voltage

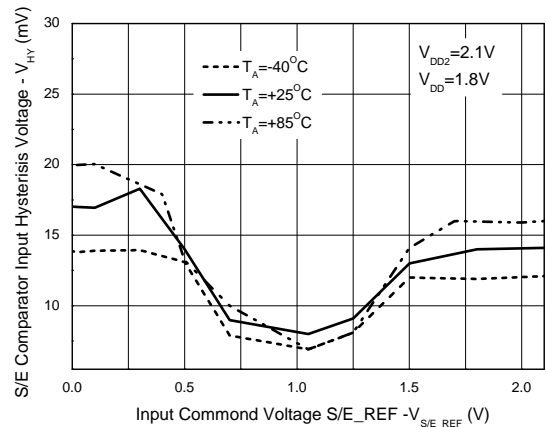

S/E Comparator Input Internal Hysteresis Voltage Characteristics



**Performance Characteristics** (Cont.) (Typical Values are referenced to  $V_{DD} = 1.8V$ ,  $V_{DD2} = 2.1V$ , unless otherwise noted.)

NEW PRODUCT

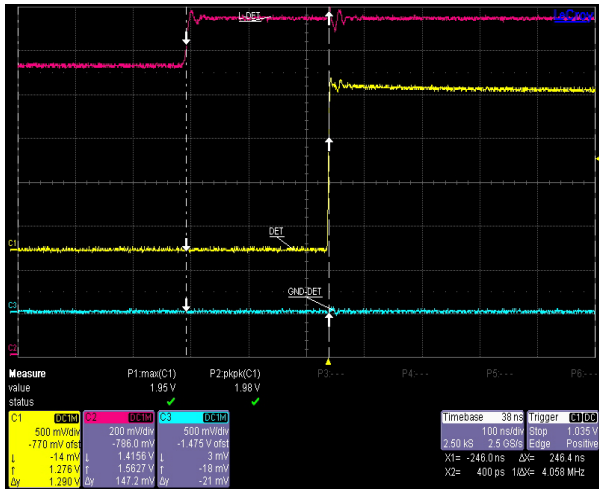

L\_DET to DET Propagation Delay

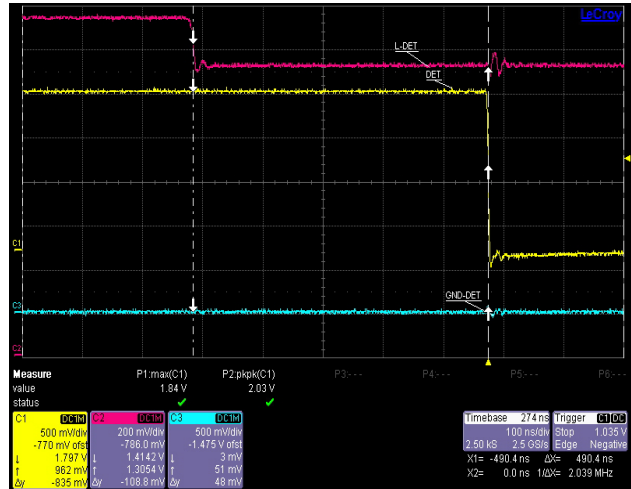

L\_DET to DET Propagation Delay

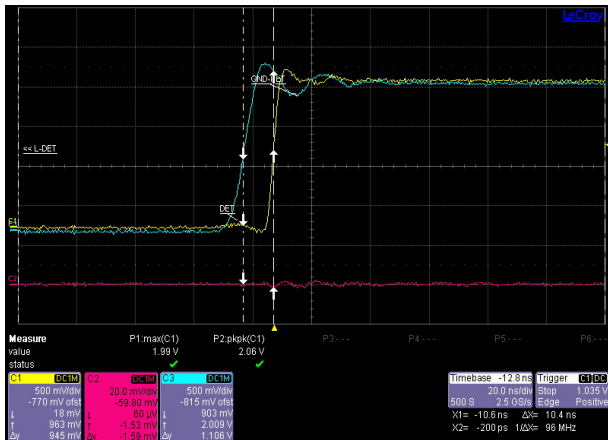

GND\_DET to DET Propagation Delay

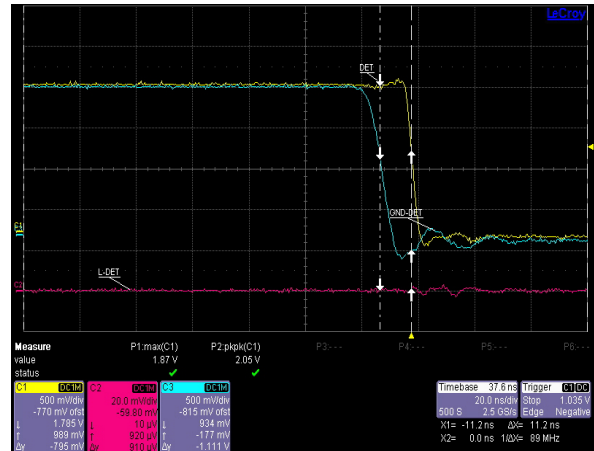

GND\_DET to DET Propagation Delay

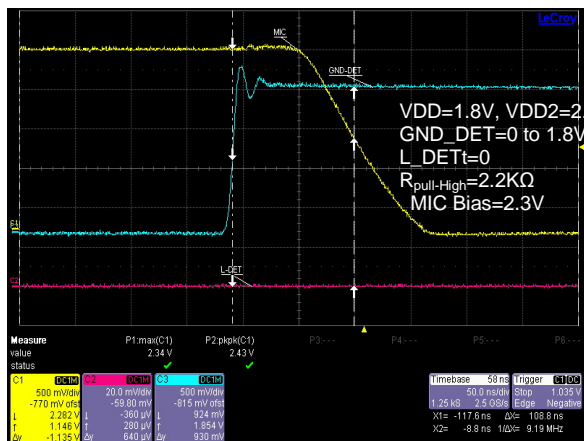

GND\_DET to MIC Propagation Delay

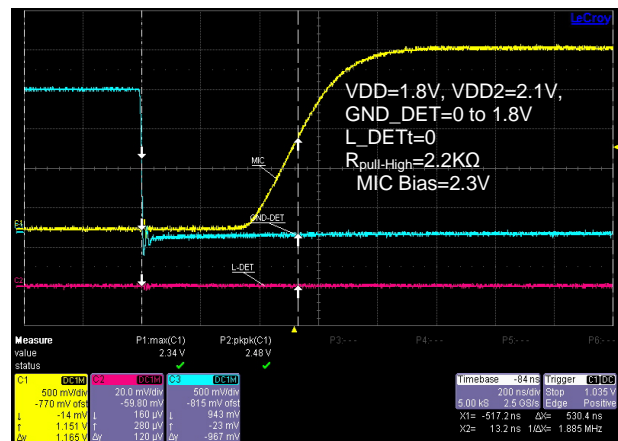

GND\_DET to MIC Propagation Delay

**Performance Characteristics (Cont.)** (Typical Values are referenced to  $V_{DD} = 1.8V$ ,  $V_{DD2} = 2.1V$ , unless otherwise noted.)

NEW PRODUCT

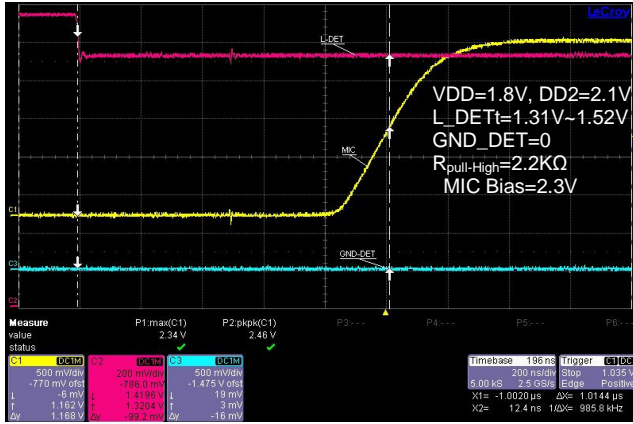

L\_DET to MIC Propagation Delay

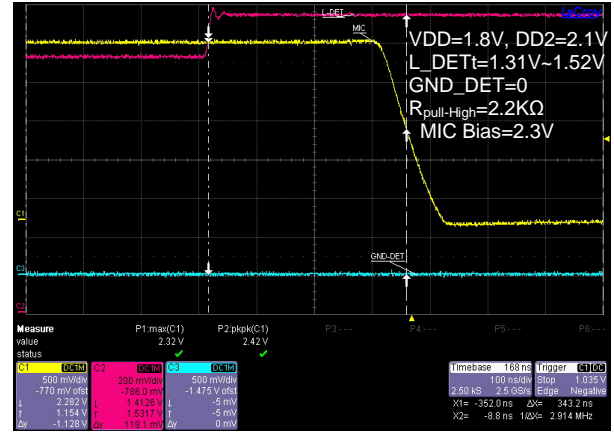

L\_DET to MIC Propagation Delay

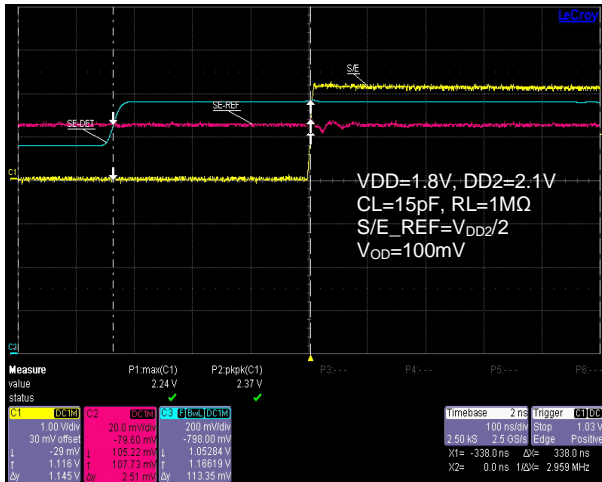

S/E Output Propagation Delay

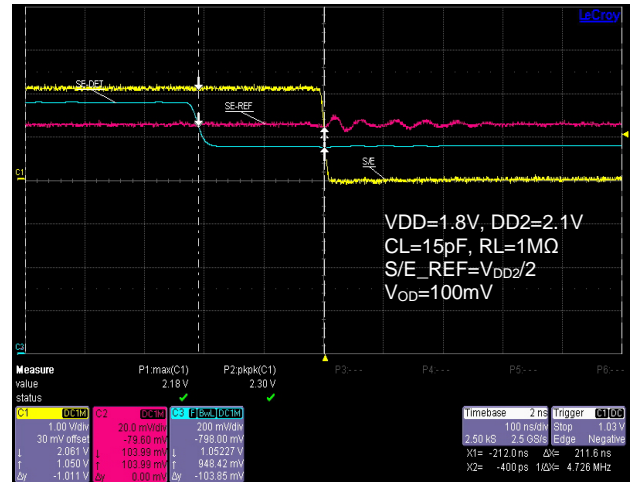

S/E Output Propagation Delay

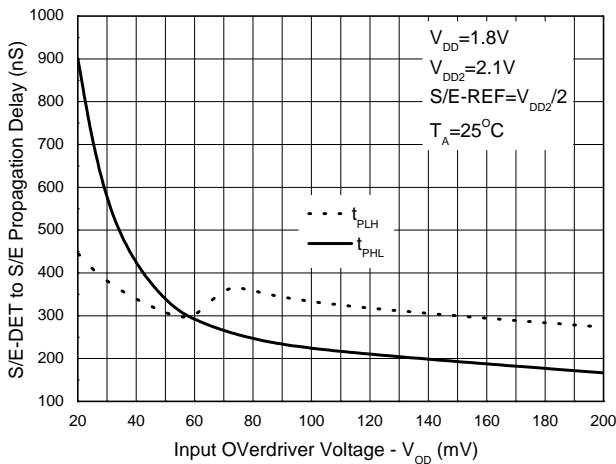

S/E Comparator Output Propagation Delay

## Application Information

---

### Supply Voltages

The AZV5002 works with a wide supply voltages range from 1.6V to 5.5V.  $V_{DD}$  should be powered up before  $V_{DD2}$ . The send/end detection comparator will not be functional unless  $V_{DD}$  and  $V_{DD2}$  are both applied.  $V_{DD2}$  can be connected to  $V_{DD}$  or to a separate supply voltage, such as the MIC bias voltage. Decoupling capacitors of 0.1 $\mu$ F should be placed as close as possible to each power supply pin.

### Audio Jack Detection

The AZV5002 is designed to simplify the detection of a stereo audio connector with a microphone contact. When the headset is not connected, the internal pull-up resistors on L\_DET and GND\_DET pull those pins high. When the headset is connected to the switched audio jack, the headset ground and left audio channel trigger L\_DET and GND\_DET to logic low.

The AZV5002 can work with either the CTIA or OMTP standard. In order to support both standards simultaneously, a cross point switch and additional circuitry is necessary to detect and swap the ground and microphone pins.

### Send/End Button Press Detection

A second integrated comparator allows the send/end signal to be compared with a reference voltage to detect whether the send/end button has been pressed.

### MIC Pin Biasing

The AZV5002 typical application circuit in Figure 2 shows the recommended 2.2K $\Omega$  pull-up resistor to the MIC bias voltage under supply voltage 1.8V condition. While the headset is not detected, the internal NMOS transistor is enabled to mute the MIC signal. If the MIC sink current is 1mA under system application, the MIC pin is pulled near 5.5mV when the headset is not present. The internal NMOS transistor is optimized to sink up to 2mA of current, allowing some flexibility in the selection of the pull-up resistor and MIC bias voltage.

**Ordering Information** (Note 5)

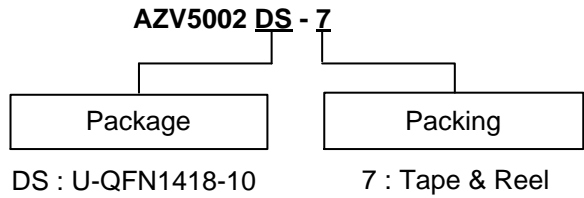

Part Number	Package Code	Packaging	7" Tape and Reel	
			Quantity	Part Number Suffix
AZV5002DS-7	DS	U-QFN1418-10	3000/Tape & Reel	-7

Note: 5. Pad layout as shown in Diodes Incorporated's package outline PDFs, which can be found on our website at <http://www.diodes.com/package-outlines.html>.

**Marking Information**

U-QFN1418-10

(Top View)

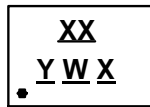

- XX : Identification Code
- Y : Year : 0~9
- W : Week : A~Z : 1~26 week;  
a~z : 27~52 week; z represents 52 and 53 week
- X : Internal Code

Part Number	Package	Identification Code
AZV5002DS-7	U-QFN1418-10	KG

**Package Outline Dimensions**

Please see <http://www.diodes.com/package-outlines.html> for the latest version.

**U-QFN1418-10**

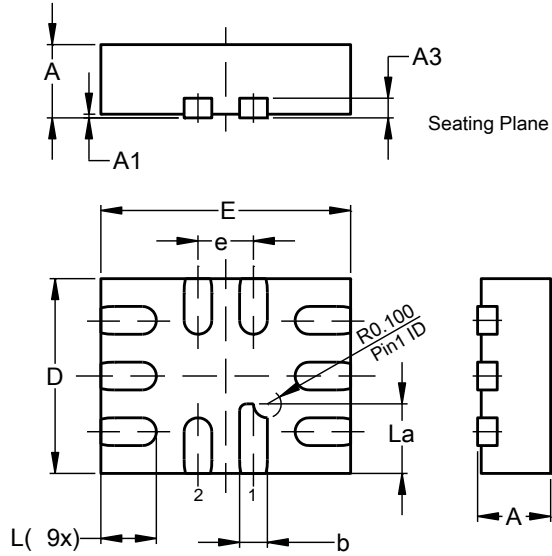

U-QFN1418-10			
Dim	Min	Max	Typ
A	0.45	0.55	0.50
A1	0.00	0.05	0.02
A3	--	--	0.13
b	0.15	0.25	0.20
D	1.35	1.45	1.40
E	1.75	1.85	1.80
e	--	--	0.40
L	0.35	0.45	0.40
La	0.45	0.55	0.50
All Dimensions in mm			

**Suggested Pad Layout**

Please see <http://www.diodes.com/package-outlines.html> for the latest version.

**U-QFN1418-10**

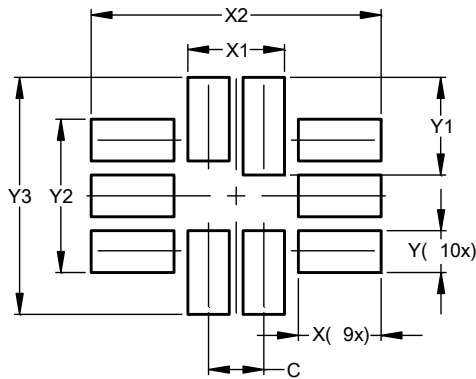

Dimensions	Value (in mm)
C	0.400
X	0.600
X1	0.700
X2	2.100
Y	0.300
Y1	0.700
Y2	1.100
Y3	1.700

NEW PRODUCT

**Taping Orientation** (Note 6)

For U-QFN1418-10

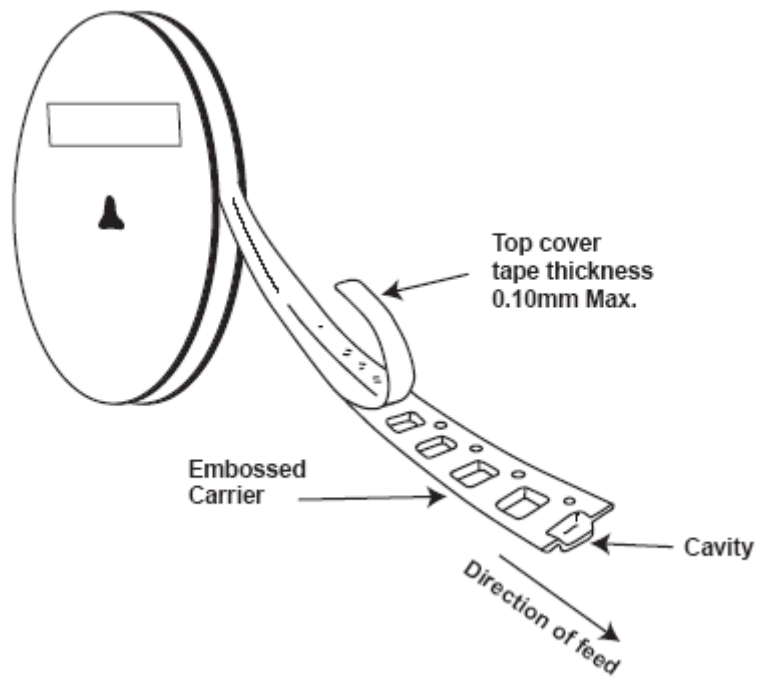
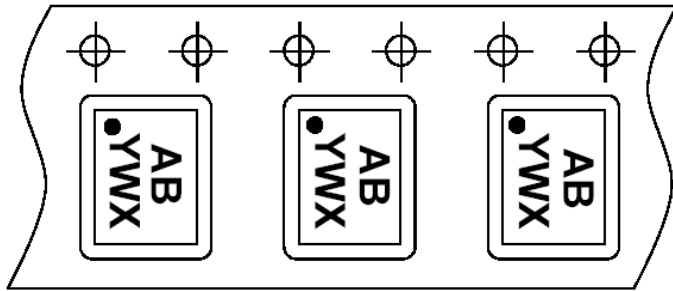

Note: 6. The taping orientation of the other package type can be found on our website at <http://www.diodes.com/datasheets/ap02007.pdf>

**IMPORTANT NOTICE**

DIODES INCORPORATED MAKES NO WARRANTY OF ANY KIND, EXPRESS OR IMPLIED, WITH REGARDS TO THIS DOCUMENT, INCLUDING, BUT NOT LIMITED TO, THE IMPLIED WARRANTIES OF MERCHANTABILITY AND FITNESS FOR A PARTICULAR PURPOSE (AND THEIR EQUIVALENTS UNDER THE LAWS OF ANY JURISDICTION).

Diodes Incorporated and its subsidiaries reserve the right to make modifications, enhancements, improvements, corrections or other changes without further notice to this document and any product described herein. Diodes Incorporated does not assume any liability arising out of the application or use of this document or any product described herein; neither does Diodes Incorporated convey any license under its patent or trademark rights, nor the rights of others. Any Customer or user of this document or products described herein in such applications shall assume all risks of such use and will agree to hold Diodes Incorporated and all the companies whose products are represented on Diodes Incorporated website, harmless against all damages.

Diodes Incorporated does not warrant or accept any liability whatsoever in respect of any products purchased through unauthorized sales channel. Should Customers purchase or use Diodes Incorporated products for any unintended or unauthorized application, Customers shall indemnify and hold Diodes Incorporated and its representatives harmless against all claims, damages, expenses, and attorney fees arising out of, directly or indirectly, any claim of personal injury or death associated with such unintended or unauthorized application.

Products described herein may be covered by one or more United States, international or foreign patents pending. Product names and markings noted herein may also be covered by one or more United States, international or foreign trademarks.

This document is written in English but may be translated into multiple languages for reference. Only the English version of this document is the final and determinative format released by Diodes Incorporated.

**LIFE SUPPORT**

Diodes Incorporated products are specifically not authorized for use as critical components in life support devices or systems without the express written approval of the Chief Executive Officer of Diodes Incorporated. As used herein:

A. Life support devices or systems are devices or systems which:

1. are intended to implant into the body, or
2. support or sustain life and whose failure to perform when properly used in accordance with instructions for use provided in the labeling can be reasonably expected to result in significant injury to the user.

B. A critical component is any component in a life support device or system whose failure to perform can be reasonably expected to cause the failure of the life support device or to affect its safety or effectiveness.

Customers represent that they have all necessary expertise in the safety and regulatory ramifications of their life support devices or systems, and acknowledge and agree that they are solely responsible for all legal, regulatory and safety-related requirements concerning their products and any use of Diodes Incorporated products in such safety-critical, life support devices or systems, notwithstanding any devices- or systems-related information or support that may be provided by Diodes Incorporated. Further, Customers must fully indemnify Diodes Incorporated and its representatives against any damages arising out of the use of Diodes Incorporated products in such safety-critical, life support devices or systems.

Copyright © 2016, Diodes Incorporated

[www.diodes.com](http://www.diodes.com)

Компания «Океан Электроники» предлагает заключение долгосрочных отношений при поставках импортных электронных компонентов на взаимовыгодных условиях!

Наши преимущества:

- Поставка оригинальных импортных электронных компонентов напрямую с производств Америки, Европы и Азии, а так же с крупнейших складов мира;
- Широкая линейка поставок активных и пассивных импортных электронных компонентов (более 30 млн. наименований);
- Поставка сложных, дефицитных, либо снятых с производства позиций;
- Оперативные сроки поставки под заказ (от 5 рабочих дней);
- Экспресс доставка в любую точку России;
- Помощь Конструкторского Отдела и консультации квалифицированных инженеров;
- Техническая поддержка проекта, помощь в подборе аналогов, поставка прототипов;
- Поставка электронных компонентов под контролем ВП;
- Система менеджмента качества сертифицирована по Международному стандарту ISO 9001;
- При необходимости вся продукция военного и аэрокосмического назначения проходит испытания и сертификацию в лаборатории (по согласованию с заказчиком);
- Поставка специализированных компонентов военного и аэрокосмического уровня качества (Xilinx, Altera, Analog Devices, Intersil, Interpoint, Microsemi, Actel, Aeroflex, Peregrine, VPT, Syfer, Eurofarad, Texas Instruments, MS Kennedy, Miteq, Cobham, E2V, MA-COM, Hittite, Mini-Circuits, General Dynamics и др.);

Компания «Океан Электроники» является официальным дистрибьютором и эксклюзивным представителем в России одного из крупнейших производителей разъемов военного и аэрокосмического назначения «JONHON», а так же официальным дистрибьютором и эксклюзивным представителем в России производителя высокотехнологичных и надежных решений для передачи СВЧ сигналов «FORSTAR».



## JONHON

«JONHON» (основан в 1970 г.)

Разъемы специального, военного и аэрокосмического назначения:

(Применяются в военной, авиационной, аэрокосмической, морской, железнодорожной, горно- и нефтедобывающей отраслях промышленности)

«FORSTAR» (основан в 1998 г.)

ВЧ соединители, коаксиальные кабели, кабельные сборки и микроволновые компоненты:

(Применяются в телекоммуникациях гражданского и специального назначения, в средствах связи, РЛС, а так же военной, авиационной и аэрокосмической отраслях промышленности).



Телефон: 8 (812) 309-75-97 (многоканальный)

Факс: 8 (812) 320-03-32

Электронная почта: [ocean@oceanchips.ru](mailto:ocean@oceanchips.ru)

Web: <http://oceanchips.ru/>

Адрес: 198099, г. Санкт-Петербург, ул. Калинина, д. 2, корп. 4, лит. А